

Proceedings of the Twenty-seventh
**Western Conference
On Linguistics**

Volume 10

WECOL 98

Held at
Arizona State University
October 9-11, 1988

Edited by
Elly van Gelderen and Vida Samiian

**Department of Linguistics
California State University, Fresno
Fresno, California 93740-8001**

Copyright © 1999 by
The Department of Linguistics
California State University,
Fresno

“The Left Periphery: Some Facts
from Gungbe” Copyright © 1999
by Enoch Oladé Aboh,

“Optional Movement and Feature
Attraction” Copyright © 1999 by
Brian Agbayani

“On Some Syntactic Conditions
on Presuppositions” Copyright
© 1999 by Marc Authier and Lisa
Reed

“Argument Composition,
Contrastive Focus, and the
Internally Headed Relative
Clause in Korean”
Copyright © 1999 by Chan
Chung

“Reconsidering Weight
Complementarity in Korean
Partial Reduplication” Copyright
© 1999
by Chin Wan Chung

“Radically Local and Partial Wh-
Movement in Madurese”
Copyright © 1999 by William D.
Davies

“Onset Motivated Overcopy in
Reduplication” Copyright
© 1999
by Laura J. Downing

“Root Infinitives and Full CP
Structures: Types of Dutch
Wh-Root Infinitives”
Copyright © 1999 by Eric
Drewry

“Easy Clauses to Mistake as
Relatives: The Syntax of English
Postnominal Infinitives”
Copyright © 1999 by Stanley
Dubinsky

“‘Porque sí’: The Acquisition of
Discourse Markers in Spanish”
Copyright © 1999 by Pilar
Durán

“The Structure of a Lexicon:
Navajo (and other) Verbs”
Copyright ©
1999 by Leonard Faltz

“On the Parallelism between
Possessor Extraction and Subject
Extraction” Copyright © 1999
by Lena Gavruseva

“Discourse Restrictions on
Multiple Wh and Syntactic
Implications” Copyright © 1999
by Kleanthes Grohmann

“Hopi Nominal Reduplication
without Templates” Copyright
© 1999 by Sean Hendricks

“Everything you Always Wanted
to Know about Complementizer
Agreement” Copyright © 1999
by Eric Hoekstra and Caroline
Smits

“Case-marking and Topicality in the Korean Causative Construction” Copyright © 1999 by Jong-Bai Hwang

“Wh-Clefts in Lummi (North Straits Salish)” Copyright © 1999 by Eloise Jelinek

“The Role of Typology in L2 Acquisition” Copyright © 1999 by Euen Hyuk Jung

“A Two-Root Theory of Korean Geminate Consonants” Copyright © 1999 by Eon-Suk Ko

“Audible Silence: Silent Moras in Japanese Verse” Copyright © 1999 by Kumi Kogure and Mizuki Miyashita.

“A Constraint-based Account of Ordering Paradox between Aspiration and Cluster Simplification in Korean” Copyright © 1999 by Shinsook Lee and Mi-Hui Cho

“Embedded Topicalization in English and Japanese” Copyright © 1999 by Hideki Maki, Lizanne Kaiser, and Masao Ochi

“The DP Hypothesis and Connectedness in Specificational Sentences” Copyright © 1999 by Yuki Matsuda

“Nominative Objects and Lack of Multiple Feature-checking in Child Japanese” Copyright © 1999 by Kazumi Matsuoka

“On the Extent of Trace Deletion in ACD” Copyright © 1999 by Jason Merchant

“Linearization Properties of Romanian Clitics” Copyright © 1999 by Paola Monachesi

“Case Conversion in Japanese and the Nature of Move F” Copyright © 1999 by Masao Ochi

“Thetic/Categorical Judgment and Relative Clauses in Korean” Copyright © 1999 by Hyeson Park

“Focus Movement and Wh-Questions in Malagasy” Copyright © 1999 by Ileana Paul

“A Syntax for Adverbs” Copyright © 1999 by Eric Potsdam

“Root Infinitives in Agrammatic Speech: Dissociated Functional Projections” Copyright © 1999 by Esterella de Roo

“The Interplay between Grammar and Discourse: The Japanese Topic Marker *wa* in Subordinate Clauses” Copyright © 1999 by Mitsuaki Shimojo

“Extended Sympathy and English
Hypocoristic Truncation”
Copyright © 1999 by Seung-
Hoon Shin

“Scrambling in Double
Complement Constructions”
Copyright © 1999 by Hooi Ling
Soh

“Emergent Unmarkedness:
Alternations in Reduplicant or
Base” Copyright © 1999 by
Caro Struijke

“Multiple Wh-Questions and the
Unique Specifier Position
Hypothesis” Copyright © 1999
by Hidekazu Tanaka

“An Aspectual System in
Language Shift: A Case Study of
Baba Malay” Copyright © 1999
Elzbieta Thurgood

“Causatives in Northern Sami and
the Role of Dative Case”
Copyright © 1999 by Mikael
Vinka

“Nouns are Acquired before
Verbs: Verbal Nouns in Japanese
Children's Early Vocabulary”
Copyright © 1999 by Yoshie
Yamashita

“A Dynamic Theory of Binding”
Copyright © 1999 by Jan-Wouter
Zwart

ISBN 1-879890-09-7

Contents

The Left Periphery: Some Facts from Gungbe <i>Enoch Oladé Aboh, Université de Genève</i>	1
Optional Movement and Feature Attraction <i>Brian Agbayani, University of California, Irvine</i>	18
On Some Syntactic Conditions on Presuppositions <i>Marc Authier and Lisa Reed, The Pennsylvania State University</i>	27
Argument Composition, Contrastive Focus, and the Internally Headed Relative Clause in Korean <i>Chan Chung, Dongseo University</i>	41
Reconsidering Weight Complementarity in Korean Partial Reduplication <i>Chin Wan Chung, Indiana University</i>	56
Radically Local and Partial Wh-Movement in Madurese <i>William D. Davies, University of Iowa</i>	71
Onset Motivated Overcopy in Reduplication <i>Laura J. Downing, University of California Berkeley</i>	81
Root Infinitives and Full CP Structures: Types of Dutch Wh-Root Infinitives <i>Eric Drewry, Tunghai University, and the University of Delaware</i>	97
Easy Clauses to Mistake as Relatives: The Syntax of English Postnominal Infinitives <i>Stanley Dubinsky, University of South Carolina</i>	108

‘Porque sí’: The Acquisition of Discourse Markers in Spanish <i>Pilar Durán, Boston University</i>	120
The Structure of a Lexicon: Navajo (and other) Verbs <i>Leonard Faltz, Arizona State University</i>	129
On the Parallelism between Possessor Extraction and Subject Extraction <i>Lena Gavruseva, University of Iowa</i>	146
Discourse Restrictions on Multiple Wh and Syntactic Implications <i>Kleanthes Grohmann, University of Maryland, College Park</i>	157
Hopi Nominal Reduplication without Templates <i>Sean Hendricks, University of Arizona</i>	172
Everything you Always Wanted to Know about Complementizer Agreement <i>Eric Hoekstra and Caroline Smits, Meertens Instituut, Amsterdam</i>	189
Case-marking and Topicality in the Korean Causative Construction <i>Jong-Bai Hwang, University of Oregon</i>	201
Wh-Clefts in Lummi (North Straits Salish) <i>Eloise Jelinek, University of Arizona</i>	211
The Role of Typology in L2 Acquisition <i>Euen Hyuk Jung, Georgetown University</i>	230
A Two-Root Theory of Korean Geminate Consonants <i>Eon-Suk Ko, University of Pennsylvania</i>	243

Audible Silence: Silent Moras in Japanese Verse <i>Kumi Kogure and Mizuki Miyashita,</i> <i>University of Arizona</i>	258
A Constraint-based Account of Ordering Paradox between Aspiration and Cluster Simplification in Korean <i>Shinsook Lee and Mi-Hui Cho, Hoseo University and</i> <i>Pukyong National University</i>	273
Embedded Topicalization in English and Japanese <i>Hideki Maki, Lizanne Kaiser, and Masao Ochi,</i> <i>Salem-Teikyo University, Yale University, and</i> <i>University of Connecticut</i>	289
The DP Hypothesis and Connectedness in Specificational Sentences <i>Yuki Matsuda, University of Washington</i>	305
Nominative Objects and Lack of Multiple Feature-checking in Child Japanese <i>Kazumi Matsuoka, University of Memphis</i>	321
On the Extent of Trace Deletion in ACD <i>Jason Merchant, University of California, Santa Cruz</i>	327
Linearization Properties of Romanian Clitics <i>Paola Monachesi, Utrecht University</i>	336
Case Conversion in Japanese and the Nature of Move F <i>Masao Ochi, University of Connecticut</i>	354
Thetic/Categorical Judgment and Relative Clauses in Korean <i>Hyeson Park, University of Arizona</i>	370

Focus Movement and Wh-Questions in Malagasy <i>Ileana Paul, McGill University</i>	383
A Syntax for Adverbs <i>Eric Potsdam, Yale University</i>	397
Root Infinitives in Agrammatic Speech: Dissociated Functional Projections <i>Esterella de Roo, Holland Institute of Generative Linguistics, Leiden</i>	412
The Interplay between Grammar and Discourse: The Japanese Topic Marker <i>Wa</i> in Subordinate Clauses <i>Mitsuaki Shimojo, SUNY Buffalo</i>	425
Extended Sympathy and English Hypocoristic Truncation <i>Seung-Hoon Shin, Dongseo University</i>	440
Scrambling in Double Complement Constructions <i>Hooi Ling Soh, University of Michigan/ Wayne State University</i>	452
Emergent Unmarkedness: Alternations in Reduplicant or Base <i>Caro Struijke, University of Maryland, College Park</i>	468
Multiple Wh-Questions and the Unique Specifier Position Hypothesis <i>Hidekazu Tanaka, McGill University</i>	483
An Aspectual System in Language Shift: A Case Study of Baba Malay <i>Elzbieta Thurgood, California State University, Fresno</i>	495
Causatives in Northern Sami and the Role of Dative Case <i>Mikael Vinka, McGill University</i>	510

Nouns are Acquired before Verbs: Verbal Nouns in Japanese Children's Early Vocabulary <i>Yoshie Yamashita, Naruto University of Education</i>	523
A Dynamic Theory of Binding <i>Jan-Wouter Zwart, University of Groningen</i>	533

The Left Periphery: some Facts from Gungbe'

Enoch Oladé ABOH
Université de Genève

1 Introduction

It is assumed in classical GB analysis that the left periphery consists of a unitary head C° that projects its own X-bar schema and whose specifier hosts preposed wh-phrases. Sentence (1a) is assigned structure (1b): the wh-phrase *who* moves to [spec CP] and subject-verb inversion results from so-called I-to-C movement.

- (1)a. Who has she seen ?
b. [_{CP} Who_i [_C has_j [_{IP} she t_j seen t_i]]]

Section 2 shows that an analysis in terms of a unitary head C (1b) cannot be maintained. Languages manifest distinct left peripheral constructions which involve a pre-subject position different from [spec CP]. Section 3 briefly discusses some inadequacies of the recursive CP hypothesis (cf. McCloskey (1992), Suñer (1993)). On the other hand, section 4 proposes an alternative in terms of Rizzi's (1997) split-C hypothesis. Each C-feature (e.g., topic, focus) is the syntactic head of a maximal projection that projects within the C-system and whose specifier hosts the preposed element. As shown in section 5, evidence from Gungbe strongly favours this hypothesis. Gungbe displays distinct CP-markers which express the features topic, focus, wh, interrogative, specific that are associated with the left peripheral constructions.

Granting representation (8), every instance of XP-preposing is analysed in terms of movement to the corresponding specifier position within the C-system. The presence of the distinct heads associated with those specifier positions is detected through the adjacency and/or anti-adjacency effects that they trigger. The contrast in (9a-b) illustrates the adjacency effect on case, while sentences (10a-b) exemplify the anti-adjacency effect on the so-called *that-t* effect.

- (9)a. for John to leave tomorrow
 b. *for, tomorrow, John to leave
- (10)a. *An amendment which they say that t will be law next year
 b. An amendment which they say that, next year, t will be law

Sentence (9b) is ungrammatical because the preposed adverbial phrase *tomorrow* occupies the specifier position of a topic phrase TopP whose head Top° creates a barrier for case assignment. Under Relativized Minimality, the complementizer *for* is too far away to determine the case of the subject (cf. Rizzi (1990)). In a similar vein sentence (10b) has improved because adverb preposing implies the intervention of a maximal projection, TopP, which projects between the complementizer and the subject trace. The latter being non-adjacent to *that* the sentence displays no *that-t* effect³.

5 The Split-C Hypothesis and the Gungbe CP-markers

The Gungbe data presented in this section strongly favour the split-C hypothesis. Sentence (11) contains an embedded clause introduced by the complementizer *dɔ̀*, the Gungbe counterpart of English *that* or French *que*.

- (11) *ùn sè dɔ̀ dàn lɔ̀ yà Kòfí wè hù ì*
 1sg hear-Perf that snake Det Top Kofi Foc kill-Perf 3sg
 'I heard that, as for the snake, KOFI killed it'

Under the split-C hypothesis, the complementizer *dɔ̀* is inserted in Force°, the head of the topmost projection of the C-system, ForceP. Observe also that the Gungbe complementizer, the topic marker (TM) *yà* and the focus marker (FM) *wè* are not in complementary distribution. They can cooccur in the fixed order Force-Topic-Focus. Before getting on to the analysis of the Gungbe TM and FM (section 5.2), let's first consider the Gungbe injunctive/subjunctive marker (IM).

5.1 Injunctive *ní* as an expression of Fin°

The Gungbe IM *ní* always appears between the subject and the verb and triggers an injunctive (or subjunctive) reading⁴. Consider, the following minimal pair (12).

- (12)a. *Kòfí jì hàn*
 Kofi sing-Perf song
 'Kofi sang a song'
- b. *Kòfí ní jì hàn*
 Kofi Inj sing song
 'Kofi should sing a song'

The only difference between sentences (12a-b) is the intervention of the IM *ní* in (12b). As a consequence, the declarative perfective sentence (12a) is changed into an order in (12b). We assume that the IM *ní* is a functional morpheme with mood force. Unlike the Gungbe tense and aspect markers, the IM *ní* immediately follows the subject and precedes the negation marker *má* (cf. 13a). This is clear indication that mood specification is not associated with TP or AspP, since negation must precede tense and aspect markers in Gungbe (13b) (cf. Aboh (1998)).

- (13)a. *Àsibá ní má wá bló*
 Asiba Inj Neg come anymore
 'Asiba should not come'
- b. *Àsibá má ná nò tón tègbè*
 Asiba Neg Fut Hab go-out everyday
 'Asiba will not habitually go out everyday'

In my account for these data, I propose that, like indicative, subjunctive or imperative clauses, the Gungbe injunctive sentences are specified for mood. In other words, these constructions involve in their C-system the feature [+injunctive] which can be analysed on a par with imperative or subjunctive as a mood specification. Granting Rizzi's (1997) proposal that the head responsible for tense/mood specifications in the C-system is Fin° , I can further assume that, in the Gungbe C-system, Fin° hosts the IM *ní* when specified as [+injunctive]. This hypothesis is corroborated by evidence from subordinate clauses⁵.

The subordinated clauses under (14) show that the subject *Àsibá* follows the complementizer *qò* and necessarily precedes mood *ní* (cf. 14a). In embedded topic/focus constructions, we find the order Comp-Topic-Focus-Mood as illustrated in (14b). This order clearly matches the characterisation of the C-system: Force-(Topic)-(Focus)-Finiteness whereby the Topic-Focus articulation is sandwiched between ForceP and FinP (cf. Rizzi (1997)).

- (14)a. *ún dḡ dḡ Àsíbá ní dḡ làn*
 1sg say-Perf that Asiba Inj cook meat
 'I said that Asiba should cook some meat'
- b. *ún dḡ dḡ làn lṣ yà Àsíbá wè ní dḡ - è*
 1sg say-Perf that meat Det Top Asiba Foc Inj cook- 3sg
 'as for the meat, I said that Asiba should cook it'

In addition, sentences (14a-b) preclude an analysis of *ní* in terms of adjunction to some head position within the C-system. Observe, for example, that *ní* is neither adjacent to Force^o *dḡ*, nor to the TM *yà* or to the FM *wè*. In a similar vein, that *ní* occurs immediately to the right of the subject cannot be seen as a manifestation of a TopP dominated by the focus projection FocP. The order Foc^o-Top^o is systematically excluded in Gungbe, hence the ungrammatical sentence (15)⁶.

- (15) **dàn lṣ wè Kòfí yà, é hú-i*
 snake Det Foc Kofi Top 3sg kill-Perf- 3sg

I suggest that the order subject-Fin^o manifested in injunctive constructions results from the satisfaction of the EPP. [spec FinP] represents the 'subject of the predication' and Fin^o the locus of mood (and tense) specifications that match those exhibited by the lower inflectional system⁷. Assuming that the Gungbe injunctive constructions lack tense projection, Fin^o appears a 'rich' finiteness node whose specifier position must satisfy EPP, (cf. Beukema & Coopman (1989), Zanuttini (1991), Aboh (1998))⁸. This is possible in Gungbe by allowing for elements that qualify as 'subject of predication' to move to [spec FinP] as illustrated in (16) below⁹.

- (16) *Kòfí ní t, má nò tón blô*
 Kofi Inj Neg Hab go-out anymore
 'Kofi shouldn't go out anymore'

Granting that [spec FinP] is not involved in case assignment, we assume that elements which need case must move cyclically through [spec AgrP] to check case features and to [spec FinP] where they satisfy the EPP. Accordingly, [spec FinP] may host heterogeneous elements: subject DPs (cf. 16), certain adverbs (cf. 17a), 'locative phrases' (cf. 17b) and elements that qualify as theme (cf. 17c-d).

- (17)a. *dédé ní kpé mì*
 slowly Inj impregnate 2pl
 'be prudent'
- b. *xò mè ní fá ná mì*
 belly in Inj fresh for 2pl
 'be cool'

- c. *yé gbà gò ló*
3pl break bottle Det
'they broke the bottle'
- d. *mì má dīké gò ló ní gbà bló*
2pl Neg allow bottle Det Inj break anymore
'don't you let the bottle break'

5.2 The focus, wh and argument topic constructions in Gungbe

Sentences under (18) contain an embedded clause introduced by the complementizer *qò* followed by a preposed element in a pre-subject position. In (18a), the topic *dàn ló* surfaces in a pre-subject position between the complementizer *qò* and the TM *yà*. Similarly, sentences (18b-c) show that the focused element *dàn ló* and the wh-word *été* follow the complementizer and immediately precede the FM *wè*.

- (18)a. *ùn sè qò dàn ló yà Kòfi hú ì*
1sg hear-Perf that snake Det Top Kofi kill-Perf 3sg
'I heard that, as for the snake, Kofi killed it'
- b. *ùn sè qò dàn ló wè Kòfi hú*
1sg hear-Perf that snake Det Foc Kofi kill-Perf
'I heard that Kofi killed THE SNAKE'
- c. *ùn kànbíó qò été wè Kòfi hú*
1sg ask-Perf that what Foc Kofi kill-Perf
'I asked what did Kofi kill?'

Assuming movement is last resort and no free preposing and adjunction to IP is permissible (Kayne (1994), Chomsky (1995)), we must admit that the C-system consists of distinct functional projections (i.e., TopP, FocP) whose specifier positions host the topic, focus and wh-elements and whose heads encode the TM *yà* and the FM *wè* respectively.

5.2.1 Focus and wh constructions

As seen from sentences (18b-c) the Gungbe focus and wh constructions are two very similar constructions. They both result from movement of the focus/wh-elements immediately to the left of the FM *wè*. Gungbe disallows focus in situ and wh in situ strategies, hence ungrammatical (19a-b). Nothing can intervene between the FM and the element immediately to its left (19c-d). Observe finally that Gungbe disallows multiple foci and multiple wh-questions (19e-f).

- (19)a. **ùn sè qò wè Kòfi hú dàn ló*
1sg hear-Perf that Foc Kofi kill-Perf snake Det

- b. **ùn kànbíʒ d̥ò wè Kòfí hù été*
 1sg ask-Perf that Foc Kofi kill-Perf what
- c. **ùn sè d̥ò dàn lɔ sò wè Kòfí hù*
 1sg hear-Perf that snake Det yesterday Foc Kofi kill-Perf
- d. **ùn kànbíʒ d̥ò été sò wè Kòfí hù*
 1sg ask-Perf that what tomorrow Foc Kofi kill-Perf
- e. *... *d̥ò dàn lɔ wè Kòfí wè hù*
 that snake Det Foc Kofi Foc kill-Perf
- f. *... *d̥ò été wè ménú wè hù*
 that what Foc who Foc kill-Perf

The Gungbe focus/wh-categories share the same surface position immediately to the left of the FM *wè*. Accordingly we propose that the focus/wh-elements occur in the specifier position of a focus projection (FocP) that projects between ForceP and FinP (cf. Ndayiragije (1993), Aboh (1998)). Recall from sentence (14b) that the focused category occurs between the complementizer *d̥ò*, the TM *yà* and the IM *ní*. We conclude that the Gungbe left periphery contains a ForceP that dominates a Focus Projection (FocP) whose head is endowed with the features [+focus, +wh,...]. At PF, these set of features are realised by the FM *wè* as represented in (20). I assume that the Focus projection is triggered only if needed, that is, when the sentence involves a focus/wh-element¹⁰ to be sanctioned by a spec-head requirement (cf. Brody (1990), Rizzi (1996) Puskàs (1992-1996), Aboh (1998)).

(20) [_{ForceP} *d̥ò* [_{FocP} XP_(+θ+wh)_i [_{Foc°} *wè* [_{FinP} *t_i*]]]]

Granting the representation (20), the grammatical sentence (21) clearly suggests that the focus domains in the main and the embedded clauses are autonomous: each can be activated separately.

- (21) *hĩ lɔ, wè Séná sè d̥ò Rèmí, wè t_i zé t_i*
 knife Det Foc Sena hear-Perf that Remi Foc take-Perf
 'Sena hear that REMI took THE KNIFE'

Sentence (21) involves long focus-movement of the embedded object *hĩ lɔ* 'knife the' to the main clause simultaneously with focusing of the noun subject of the embedded clause *Rèmí*. An immediate conclusion here is that [spec FocP] does not serve as an escape hatch for long extraction. If that were the case, sentence (21) could not be well formed: the embedded [spec FocP] would be occupied by the focused subject *Rèmí*, and there would be no room for the focused object *hĩ lɔ* 'knife the' to pass through. Accordingly, there must be some other position, say [spec ForceP], through which focus/wh-elements may pass in order to reach the main clause focus point (cf. Aboh (1998)).

5.2.2 Argument topic constructions

As shown by sentence (22a), the Gungbe topic constructions are similar to focus/wh constructions. They necessarily involve movement of the topic in a position immediately to the left of the TM *yà*. No topic in situ is allowed (22b) and no element can intervene between the TM and the topic (22c). The ungrammatical sentence (22d) indicates that, unlike Italian, Gungbe manifests no recursive topic structure.

- (22)a. *ùn sè qò dòn ló yà Kòfí hù ì*
 1sg hear-Perf that snake Det Top Kofi kill-Perf 3sg
 'I heard that, as for the snake, Kofi killed it'
- b. **yà Kòfí hù dòn ló*
 Top Kofi kill-Perf snake Det
 'as for the snake, Kofi killed it'
- c. **Kòfí sò yà é yì tò tó*
 Kofi yesterday Top 3sg go-Perf river side
 'as for Kofi, he went to the river side yesterday'
- d. **gólù ló yà àgbá ló yà Kòfí zé-é qó é mè*
 gold Det Top box Det Top Kofi put-Perf -3sg Loc 3sg in

However, the Gungbe topic constructions manifest several properties that clearly distinguish them from the focus/wh constructions.

1. Topic constructions necessarily involve an IP-internal resumptive pronoun that is identified by the topic (23a-b). The focus/wh constructions never include a resumptive pronoun (except when an embedded subject is wh-extracted or focused). Compare the following sentences (23c-d).

- (23)a. *ùn qó qò [Kòfí]_i yà é_i hù dòn ló*
 1sg say-Perf that Kofi Top 3sg kill-Perf snake Det
 'I said that as for Kofi, he killed the snake'
- b. **ùn qó qò [Kòfí]_i yà t_i hù dòn ló*
 1sg say-Perf that Kofi Top kill-Perf snake Det
- c. **ùn qó qò [Kòfí]_i wè é_i hù dòn ló*
 1sg say-Perf that Kofi Foc 3sg kill-Perf snake Det
- d. *[Kòfí]_i wè ùn qó qò *(é_i) hù dòn ló*
 Kofi Foc 1sg say-Perf that 3sg kill-Perf snake Det
 'KOFI I said killed the snake'

2. The Gungbe topic constructions involve DPs essentially, while focus/wh constructions apply to different types of constituents. The sentences (24a-b) show that when topicalization involves a postnominal phrase (PP)¹¹ only the DP inside the PP can be topicalized (24a). The PP-internal position is filled by the resumptive

pronoun preceding the postnominal morpheme *P*. In no circumstance can the whole *PP* be preposed as illustrated by the ungrammatical sentence (24b). In focus/wh constructions, however, the whole *PP* must be moved to [spec FocP] as shown by sentences (24c-d) and (24e-f).

(24)a.	<i>xò</i>	<i>lɔ</i>	<i>yà</i>	<i>Kòfí</i>	<i>bíɔ</i>	<i>é</i>	<i>mè</i>
	room	Det	Top	Kofi	enter-Perf	3sg	in
	'As for the room, Kofi entered it'						
b.	* <i>xò</i>	<i>lɔ</i>	<i>mè</i>	<i>yà</i>	<i>Kòfí</i>	<i>bíɔ</i>	<i>é</i>
	room	Det	in	Top	Kofi	enter-Perf	3sg
c.	<i>xò</i>	<i>lɔ</i>	<i>mè</i>	<i>wè</i>	<i>Kòfí</i>	<i>bíɔ</i>	
	room	Det	in	Foc	Kofi	enter-Perf	
	'Kofi entered THE ROOM'						
d.	* <i>xò</i>	<i>lɔ</i>	<i>wè</i>	<i>Kòfí</i>	<i>bíɔ</i>	<i>é</i>	<i>mè</i>
	room	Det	Foc	Kofi	enter-Perf	3sg	in
e.	<i>éte</i>	<i>mè</i>	<i>wè</i>	<i>Kòfí</i>	<i>bíɔ</i>		
	what	in	Foc	Kofi	enter-Perf		
	'where did Kofi enter?'						
f.	* <i>éte</i>	<i>wè</i>	<i>Kòfí</i>	<i>bíɔ</i>	<i>é</i>	<i>mè</i>	
	what	Foc	Kofi	enter-Perf	3sg	in	

3. Certain bare quantificational expressions such as, *nú lé kpó* 'everything' and *nú dé* 'something' resist topicalization (25a) while they can be freely focalised or wh-questioned as illustrated in (25b-c) below¹².

(25)a.	* <i>nú lé kpó</i>	<i>yà</i>	<i>Kòfí</i>	<i>sigán</i>	<i>xò</i>	<i>yé</i>
	thing Num all	Top	Kofi	can	buy	3sg
b.	<i>nú lé kpó</i>	<i>wè</i>	<i>Kòfí</i>	<i>sigán</i>	<i>xò</i>	
	thing Num all	Foc	Kofi	can	buy	
	'Kofi can buy EVERYTHING'					
c.	<i>nú té lé kpó</i>	<i>wè</i>	<i>Kòfí</i>	<i>sigán</i>	<i>xò</i>	
	thing which Num all	Foc	Kofi	can	buy	
	'what is it that Kofi can buy it all?'					

Starting from property 3, the fact that bare quantificational elements cannot be topics (cf. 25a) underscores the analysis that topics are not quantificational (cf. Cinque (1990), Lasnik & Stowell (1991), Puskàs (1996), Rizzi (1997), Aboh (1998) and subsequent work). They involve non-quantificational A'-binders and no quantificational operator-variable chain arises. As a result, quantified expressions cannot be topicalized because they must bind a variable in the IP-internal position. Sentence (25a) is therefore ruled out because the resumptive pronominal element in IP-internal position does not qualify as a syntactic variable.

- b. *Kòfí d̀ù ní?*
 Kofi eat-Perf thing
 'did Kofi eat?'

Sentences (27a-b) form a minimal pair. From the surface level, the only difference between them is the intervention of the 'ow tone in (27b) which triggers question reading, as opposed to sentence (27a) which is a statement. I propose that the low tone specific to the Gungbe yes-no questions is the reflex of a question marker (QM) which encodes the interrogative force. I further assume that this toneme originates from a morpheme that underwent partial deletion as the language evolved. Indirect evidence in support of this analysis comes from Fongbe, which exhibits a sentence-final QM *à* in yes-no questions (cf. 28).

- (28) *Kòkú yɔ́ Kòfí à?*
 Koku call-Perf Kofi QM
 'did Koku call Kofi?'

Fongbe

Under the hypothesis that interrogative force is a specification of Force^o (cf. Rizzi (1997)), the fact that the Gungbe QM occurs sentence-finally apparently contradicts the split-C analysis put forward in this study. However, the Gungbe data are perfectly consistent with an analysis in terms of movement of the whole sentence to the specifier position of the functional projection headed by the QM (i.e., the low tone). An argument that favours this hypothesis is that the complementizer *d̀* and the QM do not compete for the same position. In sentence (29) for example, the embedded yes-no question is introduced by the complementizer *d̀*. On the other hand, the QM is realised sentence-finally, hence the additional low tone on *lési* 'rice'.

- (29) *ùn kànbí's d̀ Kòfí d̀ù lési?*
 Isg ask-Perf that Kofi eat-Perf rice
 'I asked whether Kofi ate some rice'

Pursuing the split-C hypothesis, I propose that the QM encodes the interrogative force that is associated with a functional head Inter^o which projects within the C-system and whose specifier hosts interrogative phrases. Given that the interrogative phrase (or sentence) is sandwiched between the complementizer and the QM (29), I conclude that ForceP (the highest projection of the C-system) immediately dominates the functional interrogative projection, InterP. This amounts to saying that Gungbe interrogative constructions necessarily involve leftward (snowballing) movement of the whole sentence to the specifier position of the QM. As a result, the Gungbe QM must always surface in sentence-final position.

5.3.2 The use of the FM *wè* and the TM *yà* in yes-no questions

Given the discussion above, the question immediately arises whether Gungbe manifests yes-no questions where a full sentence relates to the TM, to the FM or to both. The answer to this question is yes, since it is perfectly possible (under certain pragmatic conditions) to produce yes-no questions which match the schemes XP-(*wè*)-(*yà*)- $\emptyset_{[low\ tone]}$, as shown by examples (30a-c). Sentence (30d) indicates that this strategy is also available in embedded contexts.

- (30)a. *Kòfí d̀ù lé̀sí wè́?*
 Kofi eat-Perf rice Foc-QM
 'DID KOFI EAT RICE?'
- b. *Kòfí d̀ù lé̀sí yà́?*
 Kofi eat-Perf rice Top-QM
 'did Kofi eat rice? (as it was planned)'
- c. *Kòfí d̀ù lé̀sí wè́ yà́?*
 Kofi eat-Perf rice Foc Top-QM
 'DID KOFI EAT RICE?' (as it was planned)'
- d. *ù̀n kà̀nbí's d̀ò Kòfí d̀ù lé̀sí wè́ yà́?*
 1sg ask-Perf that Kofi eat-Perf rice Foc Top-QM
 'I asked whether KOFI ATE RICE (as it was planned)'

Example (30a) is a combination of yes-no question formation and focusing of the clause *Kòfí d̀ù lé̀sí*. On the other hand, question (30b) expresses the fact that *Kòfí* will (or must) eat rice for some reason is pre-established in discourse. Finally, sentence (30c) is a combination of both strategies associated with question formation. Setting aside the different pragmatic conditions which trigger these utterances, the sentences under (30) are strong evidence for an analysis of the Gungbe yes-no questions in terms of snowballing movement.

5.3.3 Some notes on snowballing movement

It appeared in sentence (30c) that the FM precedes the TM: a mirror image of the fixed Comp-Topic-Focus order discussed in section 5.2. This is evidence that there has been snowballing movement of the whole sentence to [spec FocP]. Then after the whole FocP moves to [spec TopP], followed by movement of TopP to [spec InterP]. This gives rise to the Force^o- XP-(*wè*)-(*yà*)- $\emptyset_{[low\ tone]}$ word order found in sentence (30c) and partially represented in (31).

- (31) [_{ForceP} [_{Force^o} *d̀ò*] [_{InterP} [_{Inter^o} \emptyset] [_{TopP} [_{Top^o} *yà*] [_{FocP} [_{Foc^o} *wè*] [_{FinP} XP]]]]]]]]]]]

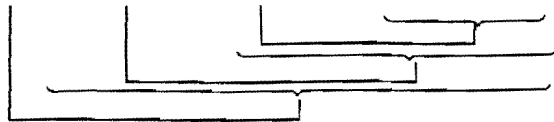

Notice that the Gungbe TM and the FM do not necessarily cooccur in yes-no questions and need not be adjacent (cf. 32a-b).

- (32)a. *làn lís yà Kòfí qù ì wě̃*
 meat Det Top Kofi eat-Perf 3sg Foc-QM
 'as for the meat did KOFI EAT IT?'
 b. *Kòfí wè qù làn yǎ?*
 Kofi Foc eat-Perf meat Top
 'did KOFI eat the meat?'

In sentence (32a), topicalization applies to *làn lís* 'the meat' prior to focusing of the comment *Kòfí qù ì* 'Kofi ate it' to [spec FocP]. Finally the whole complement of the Gungbe QM i.e. the derived clause is moved to [spec InterP] giving rise to the order topic-clause-focus-question. In examples (32b) the situation is reversed: the subject *Kòfí* is focused, followed by topicalization of the whole clause. Finally the clause is moved in [spec InterP] when yes-no question formation arises. In addition these sentences suggest that even though topicalization and focalisation are independent processes, clausal topicalization and/or focalisation only arise under yes-no question formation (cf. Aboh (1998)).

5.4 The Gungbe clausal determiner *lís*

Another context where snowballing movement operates is that of the clausal determiner. Certain Gbe languages of the Fon cluster display a clausal determiner (CD) which occurs in sentence-final position and indicates that the information being conveyed is pre-established in discourse and/or specific (33a). It is interesting to notice that the CD is morphologically and semantically identical to the Gungbe specificity marker that heads DPs (33b), see Lefebvre (1992), Law & Lefebvre (1995), Aboh (1998) and references cited there.

- (33)a. *[[qé Kòfí hòn] lís] vé ná yé*
 as Kofi flee-Perf Det_{CL} hurt-Perf for 3pl
 'as Kofi fled (instead of waiting) hurt them'
 b. *[[mótò] lís]*
 car Det
 'the (specific) car', e.g. the one we saw yesterday

Under the approach adopted in this study, a natural account for sentence (33a) is to assume that the Gungbe CD realises the C-system. Put differently there is, within the C-system, a functional projection SpfP whose head Spf⁰ is the locus of the CD and whose specifier [spec Spf] hosts the whole sentence. I provisionally assume that SpfP immediately dominates FinP headed by the Gungbe IM *ní*. This correctly predicts that in an injunctive sentence which also includes the Gungbe CP-markers,

⁷ See Cardinaletti (1997) and references cited there for an alternative in terms of the double subject positions hypothesis.

⁸ An argument that favours this hypothesis is that the Gungbe subjunctive/injunctive marker and the tense marker are in complementary distribution.

*ún	jró	dò	yé	ní	ná	sà	xwé	lɔ
1sg	want	that	3pl	Subj	Fut	sell	house	Det

I want them to sell the house'

Beukema & Coopmans (1989) proposed that imperative and subjunctive forms are similar in the sense that they are specified as [-tense, +agr]. With respect to Gungbe, this implies that injunctive and subjunctive constructions lack TP projection but contain an Agreement projection that can license the subject when needed. However since Gungbe displays no agreement or inflectional morphology, there is no empirical evidence for or against Beukema & Coopman's proposal. Granting that AgrsP is responsible for nominative case in Gungbe, the fact that pronominal elements which appear to the left of mood *ní* bear nominative case and are necessarily analysed as subject of the clause, can be said a manifestation of the [-tense, +agr] specification of Fin°.

⁹ I leave open the question of the application of subject movement to [spec FinP] in sentences where there is no overt manifestation of mood. In other words does this movement always apply in Gungbe? Notice that this is linked to a more general question of whether the CP layer is always present in a clause even if not needed.

¹⁰ See Aboh (1998) for the discussion on verbal categories focussing in Gbe.

¹¹ The Gungbe postnominal phrases cannot be considered genuine postpositions, since they are deficient for case. Even though the postnominal morpheme *P* takes a DP as complement, the Gungbe PPs manifest the same distribution as ordinary DPs: they all occur in case positions (cf. Aboh (1998)).

¹² Irrelevant to the discussion is the fact that (25c) can also have a specific reading in the sense that *nú lé kpó* refers to a specific set of things that Kofi can buy.

References

- Aboh, O. Enoch. 1998. From the Syntax of Gungbe to the Grammar of Gbe. Ph.D. dissertation, University of Geneva
- Avolonto, Aimé. 1992. 'Les particules modales en fongbe et la nature de INFL dans les phrases injonctives', *MIT Working Papers in Linguistics*, 17:1-25
- Beukema, F. & Coopmans, P. 1989. 'A Government-Binding Perspective on the imperative in English', *Journal of Linguistics*, 25: 417-436
- Brody, Michael. 1990. 'Some remarks on the Focus Field in Hungarian', *UCL Working Papers in Linguistics*, 2: 201-225
- Capo, Hounkpati. B. C. 1988. *Renaissance du Gbe: Réflexions critiques et constructives sur l'Eve, le Fon, le Gen, l'Aja, le Gun, etc.* Hamburg: Helmut Buske
- Cardinaletti, Anna. 1997. 'Subjects and clause structure', *The New Comparative Syntax*, Haegeman, L. (eds.) Longman Linguistics Library, 33-63
- Chomsky, Noam. 1995. *The minimalist Program*. Cambridge, Massachusetts: MIT Press.

- Cinque, Guglielmo. 1990. *Types of A'-Dependencies*. Cambridge, Massachusetts: MIT Press.
- Cinque, Guglielmo. 1997. *Adverbs and Functional Heads, A cross-linguistic perspective*. Oxford University Press.
- Culicover, Peter. 1992. 'Topicalization, Inversion and Complementizers in English', OTS Working Papers, *Going Romance and Beyond*, University of Utrecht
- Kayne, Richard. S. 1994. *The antisymmetry of syntax*. Cambridge, Massachusetts: MIT Press.
- Lasnik, H. & Stowell, T. 1991. 'Weakest crossover', *Linguistic Inquiry*, 22: 687-720
- Law, P. & Lefebvre C. 1995. 'On the Relationship between Event and Predicate Cleft in Kwa Languages: the Case of Fongbe', *Linguistique Africaine*, 14: 7-47
- Lefebvre, Claire. 1992. 'Agr in Languages without Person and Number Agreement: The case of the Clausal Determiner in Haitian and Fon', *Canadian Journal of Linguistics*, 37: 137-156
- McCloskey, James. 1992. 'Adjunction, Selection and Embedded Verb Second', *Working Paper LRC-92-07*, Linguistics Research Center, University of California, Santa Cruz
- Ndayiragije, Juvénal. 1993. *Syntaxe et sémantique du clivage du prédical en fongbe*. Ph.D. dissertation UQAM.
- Pollock, Jean-Yves. 1997. 'Notes on Clause Structure', *Elements of Grammar*, Haegeman, L. (eds.). Kluwer Academic Publishers, 237-279
- Puskás, Genoveva. 1992. 'The wh-criterion in Hungarian', *Rivista di Grammatica Generativa* 17: 141-186
- Puskás Genoveva. 1996. *Word order in Hungarian, the syntax of A'-positions*. Ph.D. dissertation, University of Geneva
- Suñer, Margarita. 1993. 'About Indirect Questions and Semi-Questions', *Linguistics and Philosophy* 16: 45-77
- Rizzi, Luigi 1986. 'Null Objects in Italian and the Theory of pro', *Linguistic Inquiry*, 17: 501-557
- Rizzi, Luigi. 1990. *Relativized Minimality*. Cambridge, Massachusetts: MIT Press.
- Rizzi, Luigi. 1996. 'Residual Verb Second and the wh-criterion', *Parameters and Functional Heads: Essays in Comparative Syntax*. Belletti & Rizzi (eds), Oxford University Press, 63-90
- Rizzi, Luigi. 1997. 'The fine structure of the left periphery', *Elements of Grammar*, Haegeman, L. (eds.). Kluwer Academic Publishers, 281-337
- Zanuttini, Raffaella. 1991. *Syntactic Properties of Sentential Negation. A comparative study of Romance Languages*. Ph.D. dissertation, University of Pennsylvania.

Enoch Oladé ABOH
 Département de Linguistique Générale
 Université de Genève
 2, rue de Candolle
 1211 Genève 4
 email: Enoch.Aboh@lettres.unige.ch

Optional Movement and Feature Attraction

Brian Agbayani

University of California, Irvine

1 Introduction

Fukui (1993) and Fukui and Saito (1998) have suggested that scrambling in Japanese is not driven by feature checking. These authors argue that scrambling is not an instance of feature-driven movement, and hence differs from, for example, syntactic *wh*-movement in English. One piece of evidence that has been taken to suggest that scrambling in Japanese is not feature-driven is the absence of Relativized Minimality effects with scrambling (Takano 1995; Fukui and Saito 1998). A recent conception is that Relativized Minimality effects are accounted for by the Minimal Link Condition (or MLC), which is built into the definition of Attract F in (1).

- (1) *Attract F*
K attracts F if F is the closest feature that can enter into a checking relation with a sublabel of K.¹

The MLC built into Attract F excludes any instance of feature movement in which a lower feature raises over a higher *c*-commanding feature of the same type. This accounts for *wh*-island cases such as (2).

- (2) ??Which book₁ do you wonder [where₂ John read *t*₁ *t*₂] ?

In (2), the MLC requires attraction of the closer [+*wh*] feature of *where*. Multiple scrambling in Japanese does not exhibit such an effect, as (3) and (4) show. (3a,b) are instances of multiple clause-internal scrambling, and (4a,b) are instances of multiple long-distance scrambling.

- (3) a. [IP sono hon-o₁ [John -ni₂ [Mary -ga *t*₂ *t*₁ watasita]]]
that book-Acc -to -Nom handed
b. [IP John -ni₂ [sono hon-o₁ [Mary -ga *t*₂ *t*₁ watasita]]]
-to that book-Acc -Nom handed

'Mary handed that book to John.'

- (4) a. [IP Sono hon-0₁ [John -ni₂ [Bill -ga [CP[IP Mary -ga t₂ t₁
 that book-Acc -to -Nom -Nom
 watasita] to] itta]]] (koto)
 handed that said (fact)
- b. [IP John -ni₂ [Sono hon-0₁ [Bill -ga [CP[IP Mary -ga t₂ t₁
 -to that book-Acc -Nom -Nom
 watasita] to] itta]]] (koto)
 handed that said (fact)

'Bill said that Mary handed that book to John.'

The grammaticality of the examples in (3) and (4) indicates that multiple scrambling does not obey the MLC built into Attract F, in contrast to wh-movement in English, suggesting that scrambling does not involve the application of Attract F and that it is not driven by feature checking.

A new way of treating the "unforced" or "optional" nature of scrambling is suggested based on an approach to overt movement which posits the existence of two distinct chains: (i) a (formal) feature chain, formed by Attract F, and (ii) a category chain, formed by the operation Move. The analysis opens up a novel way of treating syntactic movement in general and scrambling in particular.

2 Feature Chains and Category Chains

It is proposed in Chomsky 1995 that covert movement is restricted to feature movement, and that overt movement involves movement of an entire category for PF convergence. The economy condition in (5) determines this property.

- (5) F carries along just enough material for convergence.

According to this view, a category moves along with F only if required for PF convergence. Presumably, the derivation yields a defective output for PF if features of a single lexical item are scattered in different parts of the phrase marker.

Chomsky further suggests that movement of a category forms a separate chain (CH_{CAT}) from the chain formed by feature movement (CH_{FF}). CH_{FF} consists of the set of formal features and its trace. CH_{CAT} is formed by movement of the category. CH_{FF} is always formed whenever Attract F applies, whereas CH_{CAT} is constructed only when required for PF convergence. According to Chomsky, CH_{FF} enters into checking operations and CH_{CAT} determines the PF output. Thus, in a simple case of wh-movement, two chains would be formed, as shown in (6) (the category minus its formal features is

assumed to consist of a set of semantic features SemF and a set of phonological features PhonF):

- (6) What did Mary buy *t* ?

$$\text{CHFF} = (\text{FF}_{\text{what}}, \text{tFF}(\text{what}))$$

$$\text{CHCAT} = (\text{what}, \text{t}_{\text{what}})$$

$$[\text{SemF}, \text{PhonF}] \quad [\text{SemF}, \text{PhonF}]$$

Note that category movement differs from Attract F in one important respect: category movement is not motivated to satisfy the needs of an attractor, but rather to create a well-formed output for PF. The category "moves up" to a target to satisfy the requirements for PF convergence. This operation appears to have the property of Move motivated by Greed, rather than Attract, implying that *both* Attract *and* Move should be made available by the grammar.

Given the distinct properties associated with the formation of CHFF and CHCAT, I suggest that UG makes available both Attract and Move in the form of feature attraction and category movement, respectively (see also Ochi 1997 for a related proposal). Furthermore, I depart from the assumption that category movement applies solely for PF convergence. I propose instead that, due to language-specific factors, category movement may apply without the application of Attract F in an unforced or optional manner, perhaps related to head-complement order in the language, as suggested by Fukui (1993) and Fukui and Saito (1998).²

Furthermore, if Attract F and category movement form separate chains, then it is possible that the formation of CHFF and CHCAT are subject to separate locality restrictions. Therefore, the formation of CHFF via Attract F obeys the MLC, deriving the effects of Relativized Minimality. In the case of syntactic wh-movement in English, both CHFF and CHCAT are formed and, due to the application of Attract F, wh-movement obeys the MLC, exhibiting Relativized Minimality effects. Unlike the case of English wh-movement, I propose that Japanese scrambling involves the formation of CHCAT but not CHFF. In other words, category movement, but not Attract F applies in the case of scrambling. Therefore, scrambling in Japanese constitutes an unforced application of category movement, which is not contingent on the application of feature attraction. This captures the essence of Fukui's and Fukui and Saito's insight that scrambling is a case of overt movement that is not forced by the requirement of feature checking. Furthermore, this approach to scrambling derives the fact that scrambling does not obey the MLC built into Attract F, since CHFF is not formed in the application of scrambling.

This two-chain approach to syntactic movement opens up the question of what conditions category movement obeys. Though scrambling does not exhibit Relativized Minimality effects, other types of island effects that fall outside of Relativized Minimality are observed. Scrambling exhibits some of the island properties also associated with wh-movement in English such as the Complex

NP Constraint (or CNPC) exemplified in (7) and the Adjunct Condition exemplified in (8) (Harada 1977; Saito 1985).³ Compare the scrambling examples in (7-8) with the English wh-movement examples in (9-10).⁴

- (7) ?*ano hon-o₁ [S John -ga [NP[S e₂ *t₁* katta] hito₂] -o
 that book-Acc -Nom bought person Acc
 sagaside-iru rasii
 is looking for seems
 'It seems that John is looking for the person who bought that book.'
- (8) ??sono hon-o₁ John -ga [S' Mary -ga *t₁* yomi-oete kara]
 that book-Acc -Nom -Nom finish-reading after
 dekaketa
 went out
 'John went out after Mary finished reading that book.'
- (9) *What₁ is John looking for [DP the person who bought *t₁*] ?
- (10) *What₁ did John go out [after Mary finished reading *t₁*] ?

The analysis of scrambling as formation of CH_{CAT} without Attract F excludes an account of the CNPC and Adjunct Condition effects that appeals to the MLC built into Attract F. Furthermore, though the MLC accounts for the Relativized Minimality cases quite nicely, it appears to be silent with respect to the CNPC and Adjunct Condition effects (and Condition on Extraction Domain (or CED) effects in general). This is so because the CNPC and Adjunct Condition effects do not involve attraction of a feature over a higher c-commanding feature of the same type, as is the case in wh-island violations. Therefore, the CNPC and Adjunct Condition should fall under a separate account from wh-islands (contrary to the approach of Chomsky 1986).

The two-chain approach to overt movement opens up the possibility that formation of CH_{FF} and CH_{CAT} are each subject to separate locality conditions. Let us assume that both Attract F and category movement are subject to their own minimality conditions. It has already been assumed that the MLC regulates Attract F. I propose that formation of CH_{CAT} obeys the Shortest Move Condition (or SMC) roughly stated in (11) and adapted from Takahashi 1994.

- (11) Movement of α must proceed by adjoining to every XP dominating α .

The SMC in (11) is an economy condition that regulates the formation of CH_{CAT} , and does not affect the formation of CH_{FF} , which obeys the MLC built into Attract F. In the absence of evidence to suggest otherwise, I assume that formation of CH_{CAT} obeys the SMC but not the MLC, and that the formation of CH_{FF} obeys the MLC but not the SMC.

Furthermore, I assume the definition of adjunction in (12), from Fukui and Saito (1998).

- (12) α is adjoined to β =_{def} neither α nor β dominates the other and β does not exclude α .⁵

In light of the definition of adjunction in (12), consider the structural configuration in (13):

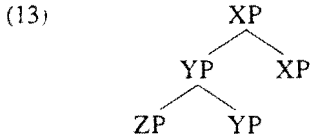

Under the definition of adjunction in (12), ZP is adjoined simultaneously to both XP and YP because XP and YP do not dominate ZP and vice versa, and neither YP nor XP excludes ZP. This indeterminacy of adjunction site is ruled out by the unique licensing condition in (14).

- (14) An adjunction site must be unique.

The unique licensing condition (14) can be generalized to a licensing condition for all non-root positions. The intuition is that every non-root position must be adjoined to, or be sister to a unique element.⁶

Now reconsider the CNPC violations repeated in (15) and (16).

- (15) *What₁ is John looking for [DP the person who bought *t₁*] ?
- (16) ?*ano hon-o₁ [S John -ga [NP[S e₂ [*t₁* katta] hito₂] -o
 that book-Acc -Nom bought person -Acc
 sagasite-iru rasi
 is looking for seems
 'It seems that John is looking for the person who bought that book.'

I assume that relative clauses are right-adjoined to DP in English and left-adjoined to NP in Japanese. Since the formation of CH_{CP} obeys the SMC, a category extracted out of a relative clause must adjoin to the adjoined CP. As shown in (17) and (18), adjunction to an adjoined phrase violates the unique licensing condition. Furthermore, skipping the illicit adjunction violates the SMC.

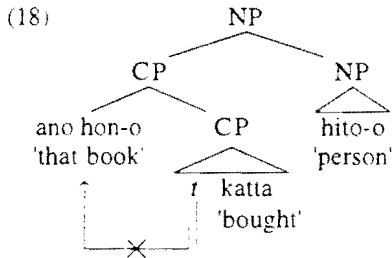
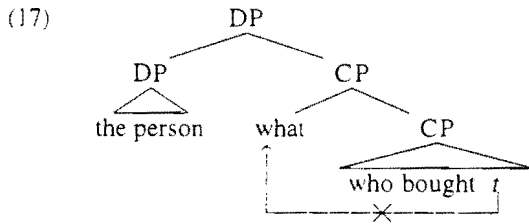

The SMC and the unique licensing condition, which regulate the formation of CHCAT, thus account for the CNPC effects exhibited by both *wh*-movement and scrambling.

Now reconsider the Adjunct Condition violations in (19) and (20).

(19) *What_i did John go out [after Mary finished reading *t*_j] ?

(20) ??sono hon-o_i John -ga [S_i Mary -ga *t*_j yomi-oete kara]
 that book-Acc -Nom -Nom finish-reading after
 dekaketa
 went out
 'John went out after Mary finished reading that book.'

Again, because the formation of CHCAT obeys the SMC, the Adjunct Condition case, like the CNPC, involves a violation of the unique licensing condition brought about by adjunction of a category to an adjoined phrase, assuming that the adjunct clauses in these examples are in adjoined positions.

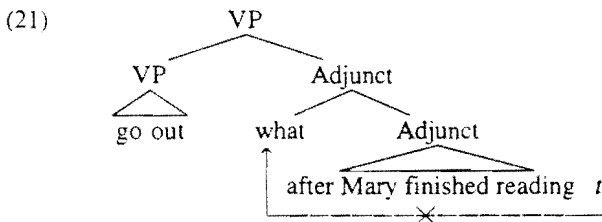

(22)

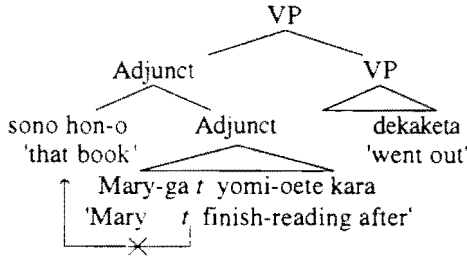

The illicit adjunction of the wh-moved or scrambled phrase causes the extracted category to be adjoined to both the adjunct and VP, in violation of unique licensing. Furthermore, the SMC is violated if movement of the category skips adjunction to the adjunct. This account therefore extends to the Adjunct Condition effect exhibited by both wh-movement and scrambling.⁷

3 Conclusion

To conclude, a two-chain approach to overt movement has been explored which splits overt movement into two parts: Attract F, which forms a feature chain CH_{FF} , and category movement, which forms a category chain CH_{CAT} . I have argued that scrambling involves the unforced formation of CH_{CAT} without CH_{FF} , and furthermore I assumed that only formation of CH_{FF} obeys the Minimal Link Condition built into Attract F. This straightforwardly accounts for the lack of Relativized Minimality effects with multiple scrambling. Finally, I have argued that the CNPC and the Adjunct Condition effects, exhibited by both scrambling *and* syntactic wh-movement, are accounted for by conditions on the formation of CH_{CAT} (namely, the Shortest Move Condition and unique licensing). The unforced or optional nature of scrambling was argued to be a result of the absence of a feature chain, and the differences in locality properties between English wh-movement on the one hand and Japanese scrambling on the other are determined simply by the type of chain formed by the movement operation in question.

Notes

¹ A *sublabel* of K is, roughly speaking, a feature associated with the head of K (see Chomsky 1994, 1995).

² According to Fukui's (1993) Parameter Value Preservation Measure, an application of Move α that preserves the canonical head-complement order in the language is deemed cost-free (hence, it can apply optionally), whereas an application of movement that creates a structure that is inconsistent with the canonical head-

complement order is deemed costly by Economy. Hence, in Japanese, an SOV language, leftward scrambling of NPs and PPs will be allowed as a cost-free operation, whereas in English, an SVO language, only rightward movement of elements within VP will be cost-free, all leftward movements in the language being costly (see Fukui 1993 for detailed discussion).

³ However, it is well known that Japanese lacks the Subject Condition (SC) effect that is found with *wh*-movement in English. I will not discuss the lack of SC effects with Japanese scrambling here, though see Agbayani 1998, Fukui and Saito 1998, and the works cited there for detailed discussion of the crosslinguistic distribution of SC effects.

⁴ The effect of extraction out of a complex NP or adjunct is "weaker" with scrambling in Japanese than it is with *wh*-movement in English (see Fukui 1991 and Agbayani 1998 for accounts of this relative strength of island effects).

⁵ Domination and Exclusion are defined as follows.

- (i) a. The category α dominates β if every segment of α dominates β .
(Chomsky 1993)
- b. α excludes β if no segment of α dominates β .
(Chomsky 1986)

⁶ (14) must be understood as a condition on operation, not on representation, as pointed out by Fukui and Saito (1998), citing a suggestion made by Masao Ochi. For example, the configuration in (13) obtains in a case like (i).

- (i) a. John's mother left.
b. [TP [DP John's [DP mother]] [TP ...]]

According to the definition of adjunction in (12), the possessor *John* would be adjoined to both DP and TP. However, *John* adjoins to DP before the entire DP *John's mother* adjoins to TP. The configuration in (ib) does not violate (14) if the condition applies only to operations, not representations.

⁷ Similar approaches to CED island effects have been explored in Ochi 1997 and Agbayani 1998

References

- Agbayani, Brian. 1998. *Feature Attraction and Category Movement*. Doctoral dissertation, University of California, Irvine.
- Chomsky, Noam. 1986. *Barriers*. Cambridge, Mass: MIT Press.
- Chomsky, Noam. 1994. Bare Phrase Structure, *MIT Occasional Papers in Linguistics* 5. Cambridge, Mass: MIT.
- Chomsky, Noam. 1995. Categories and Transformations, in N. Chomsky, *The Minimalist Program*. Cambridge, Mass: MIT Press.
- Fukui, Naoki. 1991. Strong and Weak Barriers: Remarks on the Proper Characterization of Barriers, in Nakajima (ed.), *Current English Linguistics in Japan*. Berlin: Mouton de Gruyter.
- Fukui, Naoki. 1993. Parameters and Optionality, *Linguistic Inquiry* 24: 399-420.
- Fukui, Naoki and Mamoru Saito. 1998. Order in Phrase Structure and Movement, *Linguistic Inquiry* 29: 439-474.
- Harada, S.-I. 1977. Nihongo-ni 'Henkei'-wa Hituyoo-da ("There are Transformations in Japanese"), *Gengo* 6.10: 88-95; 6.11: 96-103.

- Ochi, Masao. 1997. Move or Attract?, in *UConn Working Papers in Linguistics* 9, University of Connecticut, Storrs.
- Saito, Mamoru. 1985. *Some Asymmetries in Japanese and their Theoretical Implications*. Doctoral dissertation, MIT.
- Takahashi, Daiko. 1994. *Minimality of Movement*, Doctoral dissertation, University of Connecticut, Storrs.
- Takano, Yuji. 1995. Scrambling, Relativized Minimality, and Economy of Derivation. in *Proceedings of WCCFL 13*. Stanford: Stanford Linguistics Association.

On Some Syntactic Conditions on Presuppositions*

Marc Authier and Lisa Reed
The Pennsylvania State University

In the semantic literature, it is not uncommon to encounter the following two claims: first, that a compositional semantic theory is empirically superior to a non-compositional one; second, that there are certain aspects of semantic interpretation (known as “syntactically triggered” presuppositions) that do not seem to yield to this type of approach. While there may be good reason for accepting the first claim, accepting the second as well has the undesirable consequence of entailing an asymmetric semantic component of the grammar. That is, if both claims are correct, then there must be two fundamentally different types of processes involved in the computation of semantic meaning. The goal of this paper will be to resolve this issue by devising a means of analyzing these types of problematic data in terms compatible with semantic compositionality. In particular, it will be argued that the lexical entries of certain expressions of natural language contain presuppositions that are projected only when those lexical items are required by the syntactic component to raise to a superordinate functional domain for Focus checking purposes. Such presuppositions are, therefore, truly “syntactically triggered” in the sense that they require syntactic licensing in order to be available for interpretation.

1. The Problematic Nature of Syntactically-Triggered Presuppositions

Let us first make it clear that we embrace the widely accepted view that the semantic interpretation of a sentence is comprised of (at least) two distinct components: asserted, and presupposed meaning, a view that has arisen from Karttunen & Peters’ (1979) discussion of work by Frege (1892), Strawson (1963), and Grice (1975), among many others. This can be illustrated by means of sentences like (1), a sentence which can be said to embody the presupposition in (2a), and the assertion in (2b).

- (1) Claire has stopped watching television and her outlook on life has significantly improved.
- (2) a. Claire has watched television in the past.
b. Claire does not watch television and her outlook on life has improved.

As evidence in favor of distinguishing between the various aspects of meaning in (2a,b), consider the fact that they contrast with respect to their sensitivity to truth-conditional operators like negation. That is, only presupposed aspects of meaning are assumed to be true in neutral affirmative, negated, questioned, or conditional forms of the same basic sentence. For example, all of the sentences in (3a-d), when uttered with neutral (unstressed) intonation entail the truth of the presupposition in (4a), but only (3a) entails the truth of (4b).

- (3) a. Claire has stopped watching television.
- b. Claire hasn't stopped watching television.
- c. Has Claire stopped watching television?
- d. If Claire has stopped watching television, then she must have missed the last episode of *Unsolved Mysteries*.
- (4) a. Claire has watched television in the past.
- b. Claire does not watch television now.

Such observations have led many researchers to the following conclusion: the semantic interpretation of a given sentence is not based on a single compositional interpretation tree, but rather, on two of them (Karttunen & Peters, 1979:16). The first tree, which will be referred to as the assertion tree, contains all of the linguistic items found in the utterance, including any truth-conditional operators. In (3b), for example, the assertion tree will contain all of the lexical items in (3b), including the word not. However, the second tree, which will be called the presupposition tree, will include only those items tied to aspects of meaning whose truth is presupposed (and as a consequence will lack any of the truth-conditional operators that may be present in the utterance). The presupposition tree of (3b), for example, will contain (among other things), the material in (4a), "triggered" by the use of the word stopped in the original sentence. Given that there are two interpretation trees associated with a single sentence instead of just one, we will adopt the view that the meaning of the entire sentence is a function of the meaning of these two parts (i.e. of both trees). In a referential approach to meaning, for example, the meaning (i.e. truth value) for the sentence in (3b) will be determined as a composite of the truth values associated with each tree. Thus, if both the assertion tree and the presupposition tree are true, then the composite expression will be wholly true. If only the assertion tree is true, then the composite expression will be only partially true, and so on.

In sum, by assuming the projection and interpretation of two distinct trees, it is possible to eliminate truth-conditional operators found in the original sentence from the presupposition tree, thereby making presuppositions "immune" to these elements.

We can now return to the issue at hand, namely, the question of whether or not all aspects of semantic meaning can be analyzed compositionally. This is presently assumed to not be the case. In particular, there does exist a class of presuppositions which do not appear to be introduced compositionally at all. We will examine three such cases, but it is important to recognize that many such examples have been discussed in the literature.

Let us first consider cleft sentences such as (5a), which the standard negation, question, and conditional tests have revealed are used to encode the presupposition in (5b) (cf. Karttunen & Peters, 1975; Halvorsen, 1978; among many others for tests and discussion).

- (5) a. It was John (that) I spoke to.
 b. I spoke to someone.

Such sentences are assumed to be problematic for compositional approaches to meaning because it is not obvious just how to introduce the presupposition in (5b). Two possibilities have been explored in the literature, both of which prove unworkable under modern assumptions. First, one may attempt to tie the presupposition in (5b) to the use of a particular basic expression in the sentence, for example, in English it could be tied to the lexical item it. Unfortunately, adopting this approach has the undesirable consequence of introducing the presupposition in (5b) into all other sentences containing the item in question. For example, one would expect to find this aspect of meaning in (6) but such is not the case. And the same problem would, of course, arise if one attempted to tie this presupposition to some other lexical item in the sentence, for example John.

- (6) It would seem that I spoke to John.

The second type of approach is that the presupposition in (5b) is triggered by the cleft construction itself and not by any of the words found in it. This resolves the overgeneration problem just mentioned; however, it rests on an assumption explicitly rejected by most modern theories of syntax – namely, that particular constructions have some sort of independent status in the grammar of natural language. In other words, this approach assumes that there exists in the minds of speakers a rule of “Cleft Formation” to which the presupposition is tied. This view was, in fact, held in earlier accounts of sentence structure, such as the Transformational Grammar put forth in Chomsky (1957, 1965). However, it has since been abandoned because it leads to language-specific accounts of word order which fail to capture a significant number of generalizations both within the same language and cross-linguistically. Thus, in more recent versions of generative grammar, “clefting” is seen not as a primitive notion but as the surface manifestation of more general syntactic processes.

If this type of presupposition were a relatively rare phenomenon, we could perhaps attribute it to learned behavior, i.e. something which is not part of the language faculty. Unfortunately, such apparently “non-compositional” aspects of meaning abound. Consider for instance the case of French causative sentences, of which (7) is an example.

- (7) Marie les a fait boire du vinaigre.
 Marie them-ACC has made to-drink of-the vinegar
 ‘Marie made them drink vinegar.’

In interpreting sentences like (7), native speakers of French report that the individuals picked out by the clitic pronoun les ‘them’ are understood to have had little choice but to drink vinegar, an intuition captured by the choice of make, as opposed to get, in the English gloss (cf. Hyman & Zimmer, 1976, among many others). This phenomenon, referred to in the literature as the “direct” versus “indirect” causation contrast, is quite productive across the class of French causative verbs, as Achard (1993a,b) and Reed (1998, to appear) have shown. For present purposes what is important to note about the direct/indirect causa-

tion contrast is first, that it is presuppositional in nature. Thus, it is not possible for a truth-conditional operator to directly affect it: A question like (8), on neutral intonation, is not asking whether or not the embedded subject was acting of his or her own volition, but only whether or not the described causative and drinking events took place.

- (8) Est-ce que Marie les a fait boire du vinaigre?
 'Did Marie make them drink vinegar?'

A second observation that is important to make in relation to examples like (7) is that the reading of direct causation also takes the form of the type of presuppositions which pose a challenge to compositional semantic theories. We first note that it is difficult to see how one could tie the reading of direct causation to a particular lexical item in (7). For example, it wouldn't make much sense to assume that the clitic pronoun *les* 'them' is what is triggering this presupposition since this clitic appears in other constructions without triggering any presupposition whatsoever. Tying the presupposition to the causative verb *faire* 'to get/to make' would not work either since one would expect sentences like (9) to have only a direct causation reading, but such sentences are ambiguous between a direct and an indirect causation reading.

- (9) Marie a fait boire du vinaigre à ses amis.
 Marie has made to-drink vinegar to her friends
 'Marie made/got her friends (to) drink vinegar.'

In the case of causative sentences like (7), as was shown to be true earlier for clefts, we note that resorting to associating certain presuppositions with specific syntactic constructions, in this instance, a "causative" construction, would first of all be at odds with the view that specific constructions have no independent status in the grammar. Secondly, and perhaps more importantly, this approach will not be able to distinguish between (7) and (9) since both sentences instantiate the so-called "causative construction" yet only one is associated with a presupposition of direct causation.

As a third and final illustration of the compositionality issues raised by syntactically triggered presuppositions, consider the case of existential *there* constructions such as (10a) in which we assume, with Enç (1991), that the associate introduces a presupposition of non-specificity. That is, a *there* sentence like (10a) contrasts with its non-expletive raising counterpart (10b) in that in the latter, no presupposition of non-specificity is present.

- (10) a. There is a cow/*every cow/*the cow in the backyard.
 b. A cow/every cow/the cow is in the backyard.

In order to establish the parallel between *there* sentences and the cleft and causative sentences discussed earlier, we note first of all that the non-specificity restriction on the associate is indeed presuppositional in nature. That is, sentences like (11) clearly show that the non-specificity of the associate is preserved under a negation or a question operator.

- (11) a. There isn't a cow/*the cow in the backyard.
 b. What/*which cow is there in the backyard?

As was the case for the other constructions, any attempt to simply tie the presupposition to a lexical item in the sentence, such as there, will result in over-generation in sentences like (12).

- (12) What do you mean no one would know how to fix this engine!? At the very least there is Sue, and perhaps even Joe.

In sum, thus far we have shown that one finds in natural languages aspects of semantic meaning which appear to elude compositional analysis. While this fact could mean that semantic interpretation proceeds asymmetrically; that is, that very different processes are involved in computing these particular types of presuppositions, we would instead like to explore another means of approaching this problem. Specifically, we would like to develop an approach to the issue that recognizes that such presuppositions are indeed "syntactically triggered" but avoids using particular constructions, like clefts, as the triggers.

2. The Role of Move and Focus Checking in Activating Semantic Presuppositions

What we would like to propose is that certain items are associated in the lexicon with presupposed material that is projected only when they meet the following structural description:

- (13) If α is an item associated in the lexicon with β , β a presupposition of the appropriate type, β will be visible in the presupposition tree of the sentence containing α iff (i) α is, at any time in the derivation, part of a phrase which checks off a focus feature and (ii) α ends up in a functional domain other than the one which immediately dominates the lexical domain in which α entered the derivation.

Consider first the existential presupposition found in clefts. What we wish to propose is that ANY cleftable phrase is lexically associated with such a presupposition. This presupposition, however, is only projected when the phrase is clefted: that is, when it meets the structural requirements in (13). We adopt here the direct movement analysis proposed for clefts in Kiss (1998). Kiss analyzes the clefted phrase as entering the derivation in the embedded CP and moving to the specifier position of a Focus Phrase headed by the copula which takes the embedded CP as its complement. On this view, the wh-element which sometimes may appear in Spec-CP simply serves to signal the proposed nature of the clefted constituent and/or the incompleteness of the CP following it. Indeed, as pointed out by Rochemont (1986), wh-elements in clefts can only be used by analogy to relative pronouns and then only when the head is nominal as shown in (14):

- (14) a. It's Velma that/who Fred married.
 b. It's the dog that/?which is barking.
 c. It's tomorrow that/?*when Fred will arrive.
 d. It was in Boston that/?*where they held the tea party.
 e. It was on Smiley that/*(on) whom the sheriff placed the blame.

On the movement analysis of clefted constituents which we adopt here, a sentence like (15a) is assumed to have the structure in (15b):

- (15) a. It was to Velma that Fred spoke.

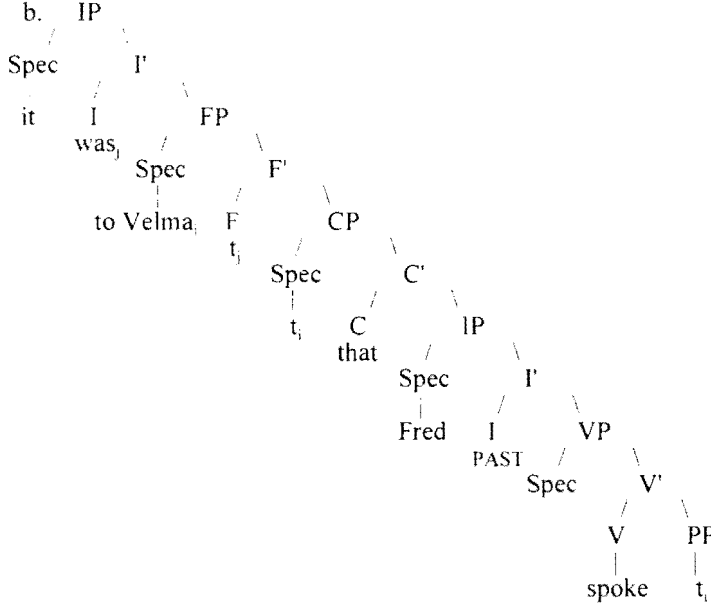

The structure in (15b) embodies the claim that the clefted phrase moves out of the embedded clause to a higher functional domain in which it checks off a Focus feature. On this type of analysis, one correctly predicts that clefts should display connectedness effects of the type illustrated in (16):

- (16) It is herself that Velma trusts the most.

As far as we can see there are only two potential objections to such a direct movement analysis of clefts. First, as pointed out by Akmajian (1970), in English clefts, the embedded verb does not agree in person with a first or second person clefted subject as shown in (17):

- (17) It's me that is/*am sad.

The significance of this fact is unclear, however, when one considers French clefts which generally display properties akin to English clefts yet allow this type of agreement as can be seen in (18):

- (18) C'est moi qui suis triste.
it-is me that am sad

It also seems relevant to note in this respect that Kayne's (1994) Linear Correspondence Axiom-based theory leads to the conclusion that relative clauses must receive a direct movement analysis. Yet, the head of nonrestrictive relatives does not agree with the embedded verb either as shown in (19):

- (19) As for me, who is/*am always optimistic, ...

A second objection one could raise regarding a Kiss-style analysis of clefts is that there is a subset of cleft sentences in which the gap in the embedded clause does not appear to correspond to the clefted phrase but, rather, to the wh-phrase which appears in Spec-CP. An example of this type is given in (20):

- (20) It was Velma to whose father I spoke.

What we would like to suggest for such cases is a Kayne-style analysis of nonrestrictive relatives adapted to clefts. That is, the derivation of (20) would be as in (21), a structure in which the clefted phrase, *Velma*, also originates in the embedded clause but is part of a larger phrase which moves to Spec-CP.

- (21) [IP It was [FP Velma, [CP [PP t, [P' to who [t,]]'s father] [C]

On this analysis, clefts and nonrestrictive relatives are expected to exhibit some similarities. Interestingly, such similarities do exist. For example, Kayne (1994: 114-15) points out that unlike restrictive relatives, nonrestrictive relatives cannot have a universally quantified phrase as their head. This is illustrated by the contrast in (22):

- (22) a. John ate every cookie which they baked.
b. *John ate every cookie, which they baked.

The same restriction is found in clefts, an observation due to Higginbotham (1987) and illustrated in (23).

- (23) *Was it every Irish poem John recited?
(Where what is excluded is the interpretation "Did John recite every Irish poem (or did he recite something else)?")

Another restriction found in nonrestrictive relatives is that, unlike their restrictive counterparts, they do not preserve the integrity of idiom chunks. This observation is due to Vergnaud (1974: 181) who pointed out contrasts such as the one in (24):

- (24) a. the headway which we made
 b. *the headway, which we made

That clefts exhibit the same restriction is shown in (25):

- (25) *It was some headway that we made.

Thus, a Kiss-style movement analysis of cleft sentences which takes the clefted constituent to move out of the embedded clause to a superordinate FP projection appears to be the most comprehensive treatment of clefting available at this point in time. It also corresponds to the structural description in (13), which allows us to treat the existential presupposition associated with clefts in a compositional manner.

Consider next the case of French causative sentences. Our hypothesis will be that the presupposition of direct causation is associated with any accusative clitic in the lexicon, but activated only when such clitics meet the structural requirements in (13). In French causative sentences like (26), it has long been assumed that the argument which follows the complex *faire* + V enters the derivation as the external argument of the embedded predicate (see e.g., Kayne, 1975; Burzio, 1986; Baker, 1988; Reed, 1996: chapter 2). That is, if one assumes that the clitic *le* in (26) enters the derivation in the Spec position of an embedded VP, then it straightforwardly follows that the property of driving Corinne's car is predicated of this argument.

- (26) Corinne le fait conduire sa voiture.
 Corinne him-FAIRE drive her car
 'Corinne makes/*gets him-ACC (to) drive her car.'

We assume that the clitic *le* in (26) cannot have its Case feature checked in the embedded clause. This is because the AgrO of the embedded clause must remain available to covertly check the Accusative Case feature associated with the embedded object *sa voiture*. We further assume, following Chomsky & Lasnik (1991), that the T of an infinitival clause has a strong EPP feature which must be checked off overtly and that the clitic *le* is the element which fulfill this function. Thus, the first application of Move to the clitic in (26) produces (27):

- (27) [TP *le*_i [AgrOP [VP *t*_i conduire sa voiture]]]
 him drive her car

Next, we assume, following in essence the analysis of French causatives defended in Reed (1996: chapter 2), that *faire* selects a CP the head of which is endowed with a strong Focus feature. This feature attracts to the Spec of CP the AgrOP in (27), yielding (28):

- (28) fait [CP [AgrOP_j [VP *t*_i conduire sa voiture]] [TP *le*_i *t*_j]]

Note that in (28), the clitic now has a trace (or copy) in the focused phrase in Spec-CP and that therefore the first clause of (13) is fulfilled. It is now obvious that regardless of what other mechanisms come into play at later stages of the derivation of (26), the clitic *le* will have to move to the superordinate checking

domain, specifically, to the AgrOP dominating the VP headed by the causative verb, in order to check its accusative Case feature. This is because the lower AgrO heading the focused phrase in Spec-CP must be available in LF to check off the Case feature of the embedded object sa voiture. Given that at Spell-Out, the clitic appears on the causative verb, and that all clitics appear on verbs at Spell-Out in French, we further assume that faire has a strong categorial feature; perhaps a D feature or a Clitic feature. Thus, the clitic le moves up to a superordinate checking domain to check off both a Case feature and a categorial feature, and in so doing fulfills the second clause of (13). As a result, the presupposition of direct causation introduced by that clitic is expected.

As a final piece of evidence in favor of the principle in (13), we turn to the presupposition of non-specificity found on the associate in there-sentences. The standard modern treatment of there existential constructions like (29) assumes that the associate strange men raises in LF to the checking domain of T for Case checking purposes while there is an expletive element which checks off the strong EPP feature of T prior to Spell-Out.

- (29) There are strange men in the garden.

While Chomsky (1995) argues that this is the proper analysis of this construction, based on the fact that the copula in (29) agrees not with there but with the associate, McCloskey (1991) points out that this analysis should not be extended to expletive it constructions, since they never display agreement between the verb and the postverbal argument.

There is, however, a body of evidence suggesting that Chomsky's analysis of there-sentences may be on the wrong track, at least with respect to languages like English. First, McCloskey (1991: 566 ff.4) points out that the standard approach leaves unexplained some differences between the agreement possibilities for preverbal and postverbal arguments in there-constructions. This is illustrated in (30).

- (30) a. *A dog and a cat is in the room.
b. ?There's a dog and a cat in the room.

Second, den Dikken (1995) points out contrasts of the type in (31) which are unexpected if the associate undergoes covert movement and the binding conditions apply at LF:

- (31) a. Some applicants_i seem to each other_i to be eligible for the job.
b. *There seem to each other_i to be some applicants_i eligible for the job.

Third, den Dikken (1995) observes that the bound variable interpretation of the pronoun his in (32a) becomes unavailable in there-sentences like (32b) where the binding quantifier is the associate. This again is an unexpected contrast if one assumes Chomsky's LF movement approach to there-constructions.

- (32) a. Someone_i seems to his_i mother to be eligible for the job.
b. *There seems to his_i mother to be someone_i eligible for the job.

Finally, it has been observed that the focusing particle only must be associated with a lexical constituent in its c-command domain, be it pre-Spell-Out, as in (33a,b) or at LF, as (33c) shows.

- (33) a. *Who_i does Sue only love t_i ?
 b. *One man_i might only be t_i in the garden.
 c. Someone only loves every woman in the room.
 (Scopally unambiguous: $\exists\forall$ /* $\forall\exists$; i.e., only blocks QR of \forall)

Given this constraint, it is quite surprising, given Chomsky's analysis of there-constructions, that the associate in there-sentences can be focused by only, as shown in (34), which is to be contrasted with (33b). These facts, pointed out by Aoun & Li (1993), are predicted only if there is no movement of the associate at LF.

- (34) There might only be one man in the garden.

For these reasons, we will adopt a slightly modified version of the analysis of existential there-sentences proposed by Hoekstra & Mulder (1990), Moro (1990), and Zwart (1992), an analysis according to which such sentences constitute a particular instance of the locative inversion phenomenon discussed in Emonds (1976). One argument in favor of this view is that so-called "verbal" there-constructions are subject to the same ergativity restriction found in locative preposing constructions. That is, as shown in (35), both constructions are possible with ergative verbs without further restrictions and, as illustrated in (36), both constructions are compatible with other intransitive verbs but only if there is a locative PP present in the structure.

- (35) a. In that century occurred a catastrophe.
 b. There occurred a catastrophe (in that century).
 (36) a. Into the room/*with a dog walked a man.
 b. There walked a man into the room/*with a dog.

Hoekstra & Mulder and others analyze there as a prepositional element which enters the derivation as the predicate of a small clause the subject of which is the associate. Although syntactically on a par with other preposed locative PPs, there differs semantically from other preposed locatives in that its meaning is ultimately determined through its being in an adjunct chain with some other predicative constituent. Thus, in building up a structure for the sentence in (37a), Merge yields the partial derivation in (37b) where the small clause headed by the predicate there is merged with the adjunct predicate AP drunk, just as is the case for the small clause headed by the predicate intelligent in (37c).

- (37) a. There were quite a few nonmembers drunk.
 b. [VP were [[SC quite a few nonmembers there] drunk]
 c. Gary_i seems [[t_i intelligent] drunk]

The parallel between (37a) and (37c) is highlighted by the fact that adjectival and nominal predicates like talkative or a dean, which cannot function as second-

dary predicates of small clauses, cannot appear in there-sentences either, as shown in (38) and (39).

- (38) a. Gary seems intelligent drunk/*talkative.
 b. There were quite a few nonmembers drunk/*talkative.
- (39) a. I consider Gary a terror naked/*a dean.
 b. There was an administrator naked/*a dean.

Going back to the partial derivation in (37b), we would like to suggest that the next step involves the movement of there to the checking domain of the complex AgrS+T, a functional projection which we assume bears a matching [FOCUS] feature in PP preposing constructions. We further assume that there and its copy form a predicate chain down which the Case feature of T can percolate and be checked off at LF by the associate in a Spec-head configuration mediated by the functional projection found in small clauses. Evidence for such a functional projection is found in French small clauses like that in (40) where the subject of the small clause obligatorily agrees with the small clause predicate.

- (40) Je considère Anne intelligente.
 I consider Anne intelligent-FEM

The overall Spell-Out configuration for (37a) is therefore assumed to be as in (41).¹ Note that there can move both to the head of the embedded AgrP and to the specifier position of AgrSP because under the principle of economy of projection, this prepositional element is both a head and a maximal projection.

- (41) [ArgSP there, [TP were, [VP t_i [AgrP [[SC quite a few nonmembers t_i drunk]]]]]]

Given the structure in (41), we are now in a position to account for the non-specificity effect found on the associate in there-sentences. Let us assume that there is associated in the lexicon with the presupposition that it can only be predicated of non-specific subjects. This presupposition will be activated only when there, in checking off a [FOCUS] feature on the AgrS+T moves out of the functional domain of the small clause in which it enters the derivation to land in the functional domain of the matrix, as is the case in (41), and as our principle in (13) would lead us to expect.

In conclusion, we have suggested that the compositionality issues raised by syntactically-triggered presuppositions may be resolved by assuming that there exist elements which are lexically associated with presuppositions whose projection is limited to contexts in which such elements check off a [FOCUS] feature in a superordinate functional domain. Given this type of approach, a new question arises, namely, the issue of whether or not syntactic features other than [FOCUS] might be used to activate these aspects of meaning. This issue, we will leave open to future research.

Notes

* We would like to thank David Basilico, Terence Langendoen, Yuki Matsuda, Ana T. Pérez-Leroux, and C. Jan-Wouter Zwart for helpful discussion on the content of this paper. All remaining errors and omissions are, of course, our own.

¹ As discussed at length in Hoekstra & Mulder (1990), Jonas (1992, 1995), Zwart (1992, 1997), and Chomsky (1995:340-355), among others, languages like Dutch, German, and Icelandic differ from languages like English in that the former allow there sentences with transitive verbs, as illustrated by the Dutch example in (i), whereas the latter do not, as demonstrated by the ungrammaticality of (ii).

- (i) Er heeft iemand een huis gekocht.
 there has someone a house bought
 'There is someone who bought a house.'
- (ii) *There (someone) has (someone) bought (someone) a house.

Two basic accounts of this cross-linguistic variation exist. Chomsky (1995: 354) has suggested a "multiple Spec" approach to the problem, illustrated in (iii).

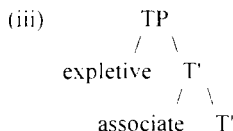

According to this view, T in languages like Dutch (but not English) has a strong nominal categorial feature which is only optionally erased when it is checked off by the associate, thereby allowing the insertion of there to recheck and erase this feature in the second Spec position.

Authors like Zwart (1992, 1997) have convincingly argued in favor of a different approach on the basis of certain facts involving PP extraposition, scrambling, and the ambiguity of certain there sentences in these languages. According to this view, the structure of transitive expletive constructions is as in (iv), a structure which we would suggest is further supported by the fact that the auxiliary verb actually separates the expletive from the associate in sentences like (i).

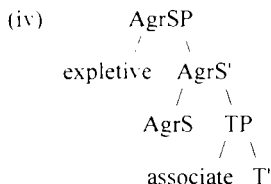

In (iv), the associate is assumed to check off the strong Nominative Case and EPP features of T. Although this aspect of the analysis remains unclear, there is presumably inserted to check off some other strong feature associated with AgrS. In order to account for the fact that the structure in (iv) is not possible in English-type languages, Zwart (1992: 490, ft. 26) suggests that only Dutch-type languages allow Nominative Case features to be checked off in the checking domain of T. English-type languages require that

AgrS and T be merged so that all of the strong features associated with both heads can be checked off in the checking domain of AgrS.

What is important to note for present purposes is that under either approach to these sentences, transitive expletive constructions are assumed to be associated with a very different syntactic structure than the one proposed in (41) in the text. (The structure in (41), incidentally, has been argued by Zwart and others to also be available in Dutch-type languages.) Specifically, the expletive in (iv) is assumed to enter the derivation in its Spell-Out position, rather than internal to a lexical domain as in (41). Given this, we would expect sentences which unambiguously have the structure in (iv) to lack a presupposition of non-specificity. While the associate in Dutch transitive expletive constructions generally displays a non-specificity effect which our account does not immediately predict, there is also evidence pointing the other way. That is, in such constructions, it is possible to find specific wh-phrases corresponding to the associate as shown in (v), due to Jan-Wouter Zwart (p.c.).

- (v) Welke mensen hebben er gisteren dat huis gekocht?
 which people have there yesterday that house bought
 'Which people (there) bought that house yesterday?'

We will leave the significance of these facts as a topic for future research.

References

- Achard, Michel. 1993a. *Complementation in French: A cognitive perspective*. Doctoral dissertation, University of California, San Diego.
- Achard, Michel. 1993b. Causative structures in French: Word order following *faire*, *laisser*, and *forcer*. In *Proceedings of the Berkeley Linguistics Society 19*, 1-12. Berkeley Linguistics Society, University of California, Berkeley, Calif.
- Akmajian, Adrian. 1970. "On deriving cleft sentences from pseudo-cleft sentences." *Linguistic Inquiry*, 1.1:149-168.
- Aoun, Joseph and Yen-hui Audrey Li. 1993. "Wh-elements in situ: Syntax or LF?" *Linguistic Inquiry*, 24.2:199-238.
- Baker, Mark. 1988. *Incorporation: A theory of grammatical function changing*. Chicago: The University of Chicago Press.
- Burzio, Luigi. 1986. *Italian syntax: A government-binding approach*. Dordrecht: Reidel.
- Chomsky, Noam. 1957. *Syntactic structures*. The Hague: Mouton.
- Chomsky, Noam. 1965. *Aspects of the theory of syntax*. Cambridge, Mass.: MIT Press.
- Chomsky, Noam. 1995. *The minimalist program*. Cambridge, Mass.: MIT Press.
- Chomsky, Noam and Howard Lasnik. 1991. Principles and parameters theory. In *Syntax: Ein internationales Handbuch zeitgenössischer Forschung*, ed. J. Jacobs, A. von Stechow, W. Sternefeld, and T. Vennemann, 506-569. Berlin: Walter de Gruyter.
- den Dikken, Marcel. 1995. "Binding, expletives, and levels." *Linguistic Inquiry*, 26.2:347-354.
- Emonds, Joseph. 1976. *A transformational approach to English syntax*. New York: Academic Press.
- Enç, Mürvet. 1991. "The semantics of specificity." *Linguistic Inquiry*, 22.1:1-25.
- Frege, Gottlob. 1892. Über Sinn und Bedeutung. In *Zeitschrift für Philosophie und philosophische Kritik* Vol. 100, 25-50. Translated as On sense and reference. In *Translations from the philosophical writings of Gottlob Frege (1952)*, ed. P.T. Geach and M. Black, 56-78. Oxford: Basil Blackwell.
- Grice, H. Paul. 1975. Logic and conversation. In *Syntax and semantics* Vol. 3, ed. P. Cole and J. Morgan, 41-58. New York: Academic Press.

- Halvorsen, Per-Kristian. 1978. The syntax and semantics of cleft constructions. *Texas Linguistic Forum 11*. University of Texas, Austin, Tex.
- Higginbotham, James. 1987. Indefiniteness and predication. In *The representation of (in)definiteness*, ed. E. Reuland and A. ter Meulen, 43-70. Cambridge, Mass.: MIT Press.
- Hoekstra, Teun and René Mulder. 1990. "Unergative as copular verbs: locational and existential predication." *The Linguistic Review*, 7.1:1-79.
- Hyman, Larry and Karl Zimmer. 1976. Embedded topic in French. In *Subject and Topic*, ed. C. Li, 191-211. New York: Academic Press.
- Jonas, Diane. 1992. Clause structure and verbal syntax of Scandinavian and English. Ms., Harvard University.
- Jonas, Diane. 1995. Transitive expletive constructions in Icelandic and Middle English. Ph.D. dissertation, Harvard University.
- Karttunen, Lauri and Stanley Peters. 1975. Conventional implicature in Montague Grammar. In *Proceedings of the Berkeley Linguistics Society 1*, 266-78. University of California, Berkeley, Calif.
- Karttunen, Lauri and Stanley Peters. 1979. Conventional implicature. In *Syntax and semantics Vol. 11*, ed. C.-K. Oh and D. Dinneen, 1-56. New York: Academic Press.
- Kayne, Richard. 1975. *French syntax: The transformational cycle*. Cambridge, Mass.: MIT Press.
- Kayne, Richard. 1994. *The antisymmetry of syntax*. Cambridge, Mass.: MIT Press.
- Kiss, Katalin. 1998. "Identificational focus versus information focus." *Language*, 74.2:245-273.
- McCloskey, James. 1991. "There, it, and agreement." *Linguistic Inquiry*, 22.3:563-567.
- Reed, Lisa. 1996. *Toward Logical Form: An exploration of the role of syntax in semantics*. New York: Garland.
- Reed, Lisa. 1998. Accessible similar worlds and French coherent infinitival constructions. In *Mathematical and computational analysis of natural language*, ed. C. Martin-Vide. Amsterdam: John Benjamins.
- Reed, Lisa. To appear. "Necessary versus probable cause." To appear in *Journal of Philosophical Logic*.
- Rochemont, Michael. 1986. *Focus in generative grammar*. Amsterdam: John Benjamins.
- Strawson, P.F. 1963. On referring. In *Philosophy and ordinary language*, ed. C. Caton, 162-193. Chicago: University of Illinois Press.
- Vergnaud, Jean-Roger. 1974. *French relative clauses*. Doctoral dissertation, MIT, Cambridge, Mass.
- Zwart, C. Jan-Wouter. 1992. Dutch expletives and small clause predicate raising. In *Proceedings of NELS 22*, 477-491.
- Zwart, C. Jan-Wouter. 1997. Transitive expletive constructions and the evidence supporting the Multiple Specifier Hypothesis. In *German: Syntactic problems-Problematic syntax*, ed. W. Abraham and E. van Gelderen, 105-134. Tübingen: Max Niemeyer Verlag.

The Pennsylvania State University
Linguistics Program & Department of French
Room 211, Burrowes Building
University Park, PA 16802

JMA11@psu.edu (Authier)

LAR13@psu.edu (Reed)

Argument Composition, Contrastive Focus, and the Internally Headed Relative Clause in Korean

Chan Chung
Dongseo University

1 Introduction

A typical example of the internally headed relative clause (IHRC) in Korean and Japanese is (1). Here the overt subject *totwuk-i* 'thief' in the embedded constituent is understood as the object of the matrix verb *capassta* while the superficial object [*totwuk-i unhayng-eyse nao-nun kes-ul*] as a whole is not.

- (1) Na-nun [totwuk-i unhayng-eyse nao-nun kes-ul] capassta.
I-Top thief-Nom bank-from come-out-Mod KES-Acc caught
'I arrested the thief who was coming out of the bank.'

This construction is debatable because it seems to violate the locality principle in that the object subcategorized for by the matrix verb, *totwuk-i* 'thief', appears within an embedded constituent. The goal of this paper is to explore the syntactic and discourse properties of the IHRC.

2 Some Syntactic Properties and Previous Analyses

Jhang (1991), Kuroda (1992), and Hoshi (1994), among others propose the NP complement analysis of the IHRC construction, illustrated in (2) after Kuroda (1992):

- (2) Na-nun [_V[_{NP}_i[_S totwuk_i-i unhayng-eyse nao-nun kes-ul]]
 I-Top thief-Nom bank-from come-out-Mod KES-Acc
 capassta]]
 caught
 'I arrested the thief who was coming out of the bank.'

This analysis proposes that the embedded constituent [*totwuk-i unhayng-eyse nao-nun kes-ul*] is an NP reanalyzed from an S, which is coindexed with *totwuk-i* 'thief' and plays the object role of the matrix verb *capassta* 'caught.'

Two other types of analyses are proposed by Murasugi (1994) and Chung (1996). Murasugi proposes an adjunct-*pro* analysis as in (3): the embedded constituent is an adjunct, and *pro* coindexed with *totwuk-i* is assumed to be the object of the matrix verb *capassta*.

- (3) Na-nun [_{VP}[_{ADJ}[_NP[_S totwuk_i-i unhayng-eyse nao-nun] kes-ul]]
 I-Top thief-Nom bank-from come-out-Mod KES-Acc
 [_{VP} *pro*_i capassta]]
 caught
 'I arrested the thief who was coming out of the bank.'

Chung, D. (1996) proposes a similar analysis to Murasugi (1994) in that it assumes the embedded constituent is an adjunct, and that *pro* is the argument of the matrix verb. However, his analysis differs from Murasugi's in that it assumes another empty perception predicate (PRED), as shown in (4):

- (4) Na-nun [_{VP} [_{ADJ}[_NP[_S totwuk_i-i unhayng-eyse nao-nun] kes-ul]
 I-Top thief-Nom bank-from come-out-Mod KES-Acc
 PRED] [_{VP} *pro*_i capassta]]
 caught
 'Seeing the thief coming out of the bank, I arrested him.'

According to this analysis, [[*totwuk-i unhayng-eyse nao-nun kes-ul*] PRED] as a whole is an adjunct, where the embedded constituent is a complement of the empty perception predicate.

One of the problems with these previous analyses is that they do not have any mechanism that accounts for the differences between (1) and (5):

- (5) Na-nun [totwuk-i unhayng-eyse nao-nun kes-ul] mallassta.
 I-Top thief-Nom bank-from come-out-Mod KES-Acc not-knew
 'I did not know that the thief was coming out of the bank.'
 But not 'I did not know the thief who was coming out of the bank.'

Sentence (1) has only an entity reading, i.e., the object of the matrix verb of (1) is the thief not the whole event. In contrast, sentence (5) has only an event reading, i.e., the object of the matrix verb of (5) is not the thief but the whole event. The difference comes from the matrix verb. When the verb is a perception verb, only the event reading is available. When it is a physical action verb, however, only the entity reading is available. Then the question is how the difference can be predicted from the syntactic perspective. In other words, if the internal structure of [*totwuk-i unhayng-eyse nao-nun kes-ul*] in (1) and (5) is assumed to be the same, and if the coindexation between *totwuk* and the whole embedded constituent is possible in both sentences, it may be hard to explain why only the physical action verb can have the entity reading. To account for the given fact, we need to assume two different internal structures of the embedded constituent.

For the two different structures for the embedded constituent, we may assume that *kes* in (1) is a non-referential noun, while *kes* in (5) is a complementizer. However, as Uda (1998) mentioned, *kes* in both sentences has the same syntactic property as a noun in that it bears accusative, nominative, or genitive case as shown in (1) and (6), while the typical clausal complementizer, *-ko* in Korean, cannot bear such case at all, as shown in (7).

- (6) a. [Ai-ka elin kes-i] yenge-lul cal hanta.
 child-Nom be-young KES-Nom English-Acc well speak
 'The young child speaks English well.' (Chung, 1996)
- b. [totwuk-i unhayng-eyse nao-nun kes-uy] chepho
 thief-Nom bank-from come-out-Mod KES-Gen arrest
 'the arrest of the thief who was coming out of the bank.'
- (7) a. Motwu-ka [John-i ton-ul hwumchessta-ko(*-lul)]
 All-Nom J-Nom money-Acc stole-Comp-(Acc)
 sayngkakhayssta.
 thought
 'All thought that John stole the money.'
- b. [John-i ton-ul hwumchessta-ko(*-ka)] sayngkak-toy-essta.
 J-Nom money-Acc stole-Comp-Nom think-Passive-Past
 'It was thought that John stole the money.'
- c. [John-i ton-ul hwuchessta-ko(*-uy)] sayngkak
 J-Nom money-Acc stole-Comp-Gen thought
 'the thought that John stole the money'

Thus if two totally different categories for *kes* are assumed, it is hard to account for the fact that *kes* in (1) and (5) has the same property of a noun.

Uda (1998) accounts for the two different readings involved in the IHRC constructions with the assumption that the adnominal clause of the *kes*-

constructions is a syntactic complement of the non-referential noun *kes*, and that the event reading arises from the structure-sharing between the semantic contents of the adnominal clause and *kes*, while the entity reading arises from the coindexation between an argument of the adnominal clause and *kes*. However, Uda's (1998) analysis has a theory-internal problem: the arguments of the adnominal clause are not available for the coindexation under the framework of Head-Driven Phrase Structure Grammar on which her analysis is based, since *kes* takes as its complement the whole clause where the arguments of the verb are all discharged. To avoid this problem, her analysis assumes that the non-head-daughter of *kes*, which is an S, has the ARGUMENT-STRUCTURE (ARG-S) and that the coindexation occurs between *kes* and an element in the ARG-S list. The problem is that in the standard view, the ARG-S cannot appear in a phrasal category. More importantly, Uda's analysis cannot account for the raising fact discussed below, and the constituenthood of "adnominal verb + *kes*" discussed in section 3.1.

Another problem with all the previous analyses arises when the example in (8) is considered:

- (8) Na-nun totwuk-ul unhayng-eyse nao-nun kes-ul capassta.
 I-Top thief-Acc bank-out-of come-Mod KES-Acc caught
 'I arrested the thief who was coming out of the bank.'

In (8), the embedded nominative subject *totwuk-i* 'thief' in (1) is realized as an accusative NP *totwuk-ul*, which suggests that the embedded subject can be "raised" to the object of the matrix verb *capassta* 'caught.' The problem with the previous analyses is that such raising is generally not allowed out of an NP or an adjunct, and thus they have to augment some device to account for the raising fact.

We may assume that (8) is not the raising construction derived from (1) but a totally different construction where the constituent [*unhayng-eyse nao-nun kes-ul*] is a kind of appositive parenthetical expression. The typical example of the parenthetical is in (9) where the head of the parenthetical is non-expletive *nom-ul* 'guy':

- (9) Na-nun totwuk-ul, ku khi-ka ku-n nom-ul, capassta.
 I-Top thief-Acc the height-Nom tall-Mod guy-Acc caught
 'I arrested the thief, the guy who was tall.'

It seems, however, that (8) cannot be considered as the parenthetical construction. If (8) and (9) are the same construction, the head noun of the parenthetical *nom-ul* in (9) may be substituted by *kes*, as in (8). However, this prediction is not born out, as shown in (10):¹

- (10)?? Na-nun totwuk-ul khi-ka khu-n kes-ul capassta.
 I-Top thief-Acc height-Nom tall-Mod KES-Acc caught
 'I arrested the thief, the one who was tall.'

In the analysis where (10) is considered as an instance of the IHRC, the sentence is ruled out simply because its non-raised version is also ill-formed as shown in (11):

- (11)?? Na-nun [totwuk-i khi-ka khu-n kes-ul] capassta.
 I-Top thief-Nom height-Nom tall-Mod KES-Acc caught
 'I arrested the thief who was tall.'

Presently, it is not clear why (11) is awkward, but it seems that the stative predicate (or adjectival predicate) is not allowed in the object IHRC.

In addition to the problems mentioned above, the adjunct-*pro* analyses proposed by Murasugi (1994) and Chung (1996) have another problem, when the examples of *pro*-substitution in (12) is considered:

- (12) a. Na-nun [_{ADJ} totwuk_i-i unhayng-eyse nao-ca maca]
 I-Top thief-Nom bank-from come-out-as soon as
 ku_i-lul/ku totwuk_i-ul/pro capassta.
 him-Acc/the thief-Acc/pro caught
 'As soon as the thief came out of the bank, I arrested him/the thief.'
- b. *Na-nun [_{ADJ}totwuk_i-i unhayng-eyse nao-nun kes-ul]
 I-Top thief-Nom bank-from come-out-Mod KES-Acc
 ku_i-lul/ku totwuk_i-ul capassta.
 him-Acc/the thief-Acc caught
 'I arrested the thief who was coming out of the bank.'

(12a) is a typical example of the adjunct construction, and in this case, *pro* can generally be substituted by an overt pronoun or R-expression when its antecedent is within an adjunct. However, in the IHRC, such substitution is not allowed as shown in (12b). So another problem with the adjunct-*pro* analysis is that it cannot account for the grammatical difference between (12a) and (12b).

To conclude this section, (i) the analysis of the IHRC needs some syntactic mechanism that can account for the difference between the entity reading and event reading, (ii) the IHRC involves a raising mechanism, and (iii) the matrix verb governing the IHRC does not take *pro* as its argument.

3 Argument Composition Analysis of the IHRC

3.1 "Verb + *Kes*" as a Complex Noun

In this subsection, it is proposed that the combination of "adnominal verb + *kes*" in the IHRC constitutes a complex noun. To this end, some parallelisms are shown between the constituency of "adnominal-verb + *kes*," and that of the verbal complex. The latter is usually analyzed as a combination of "verb + auxiliary verb" (e.g., Cho (1988), Sells (1995), and Chung (1998), among others).

In the traditional Korean grammar, *kes* in the IHRC is called an "incomplete noun" in that it always requires a verb of a modifier form *-(n)un* and in that *kes* itself cannot be used alone as a word as shown in (13):

- (13) (Na-nun totwuk-i unhayng-eyse) *(nao-nun)
 I-Top thief-Nom bank-from come-out-Mod
 kes-ul capassta.
 KES-Acc caught
 'I arrested the thief who was coming out of the bank.'

Example (13) shows that the adnominal verb of IHRC, *nao-nun* 'come-out-Mod', is not optional or cannot be realized as an empty category, and that *kes* itself cannot exist as an independent word. This shows a sharp contrast with the typical externally-headed relative clause construction in (14), where the entire relative clause including the adnominal verb *nao-nun* is optional.

- (14) (Na-nun unhayng-eyse nao-nun) totwuk-ul capassta.
 I-Top bank-from come-out-Mod thief-Acc caught
 'I arrested the thief who was coming out of the bank.'

In the Korean verbal complex construction, the same observation can be made as shown in (15):

- (15) (Na-nun sakwa-lul) *(mek-e) poassta.
 I-Top apple-Acc eat try as a test (AUX)
 'I tried an apple.'

Here the auxiliary verb *poassta* 'tried as a test' itself cannot exist as an independent word without its governed verb. However, in other constructions such as control verb constructions, the matrix verb can exist as an independent word without the governed verb, as shown in (16):

- (16) (Na-nun John-hanthey sakwa-lul mek-ulako) seltukhayssta.
 I-Top J-Dat apple-Acc eat persuaded
 'I persuaded John to eat an apple.'

Another example showing the parallelism between the IHRC and verbal complex constructions arises from the afterthought expression construction shown in (17) and (18):

- (17) a. *Na-nun kes-ul capassta, totwuk-i unhayng-eyse nao-nun.
 I-Top KES-Acc arrested thief-Nom bank-from come-out-Mod
 'I arrested the thief who was coming out of the bank.'
 b. Na-nun totwuk-ul capassta, unhayng-eyse nao-nun.
 I-Top thief-Acc arrested bank-from come-out-Mod

Here sentence (a) is an instance of the IHRC construction where the IHRC is used as an afterthought expression. It shows that the IHRC cannot be used as an afterthought expression differently from the externally headed relative clause in (17b). This suggests that *kes* and the adnominal verb constitute a syntactic unit and that they cannot be separated. The same pattern is also observed in the verbal complex construction, as shown in (18):

- (18) a. *Na-nun poassta, sakwa-lul mek-e.
 I-Top tried apple-Acc eat
 'I tried an apple.'
 b. Na-nun seltukhayssta, John-hanthey sakwa-lul mekulako.
 I-Top persuaded J-Dat apple-Acc eat
 'I persuaded John to eat an apple.'

(18a) is an instance of the verbal complex where the auxiliary verb and its governed verb cannot be separated, while (18b) is an instance of the control verb construction where the matrix verb and its governed verb can be separable.

Another parallelism between the IHRC and verbal complex constructions arises from the fact that the heads of the constructions, namely, *kes* in IHRC and the auxiliary verb in the verbal complex are a kind of clitics, diachronically derived from independent words whose phonetic forms are the same. For example, the auxiliary verb *pota* 'try as a test' in (15) and (18) has a non-auxiliary-verb counterpart *pota* 'see', which can be used as an independent word. The same observation can be made in the IHRC. The head *kes* in the IHRC can never be used as a referring expression and never take a specifier such as *ku* 'the' and *ce* 'that' as shown in (19):

- (19) * Na-nun totwuk-i unhayng-eyse nao-nun
 I-Top thief-Nom bank-from come-from-Mod
 ku kes-ul capassta.
 the KES-Acc caught
 'I arrested the thief who was coming out of the bank.'

However, there exists a referential noun counterpart *kes* 'thing', which can be used as a referring expression and can take a specifier as shown in (20).

- (20) Na-nun ku kes-ul sassta.
 I-Top the thing-Acc bought
 'I bought the thing (it).'

To sum, there are some parallelisms between the verbal complex and the combination of "adnominal verb + *kes*" in the IHRC, and thus the combination in IHRC needs to be treated as a syntactic unit, namely, as a complex noun. The following subsection proposes an analysis of the IHRC under the framework of Head-driven Phrase Structure Grammar (HPSG henceforth, Pollard and Sag (1994)).

3.2 Argument Composition in the IHRC

Hinrichs and Nakazawa (1994) introduce the mechanism of argument composition into the HPSG framework to account for the linear order of clause-final verbal sequences in German. The effect of argument composition is to "attract" or "raise" the arguments of the governed verb to the argument list of the governing verb: roughly, when a lexical category X takes Y as its arguments, the unsatisfied arguments of Y are raised to the argument(s) of X. A similar notion (verbal projection raising) is also introduced in GB by Haegem and van Riemsdijk (1986). In HPSG, argument composition is represented by structure sharing between the valence value of the governed verb and that of the governing verb.

The notion of argument composition is used in Chung (1998) to account for the verbal complexes in Korean. On this approach to verbal complexes, the auxiliary verb selects its verb by the GOV(ERNEE) feature, and the subject and complement lists of the governed verb are structure shared with (or "raised to") those of the auxiliary verb. In this analysis, the argument structures of most of the auxiliary verbs are determined by the governed verb. And the governed verb and auxiliary verb combine first, constituting a complex predicate.

Assuming the feature GOV, I propose the schematized lexical structure of *kes* of IHRC in (21):²

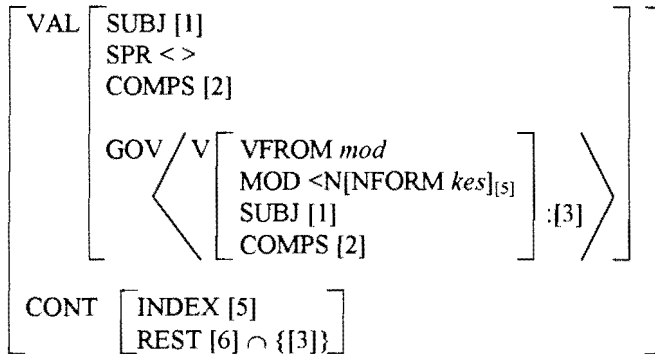
(21) Lexical structure of IHRC *kes*

Restriction: [5] = *index* (x) & (x ∈ [1] ∨ [2])

Feature structure (21) states the following: (i) *kes* takes a verb of modifier form as its verbal complement which semantically modifies it, (ii) the subject (SUBJ) and complement (COMPS) lists of the adnominal verb are raised to the subject and complement lists of *kes*, which identifies the argument structure of *kes* with that of the adnominal verb, (iii) *kes* has an empty list as its specifier value and thus cannot have a specifier, (iv) the index of *kes* is the same as one of the arguments of the adnominal verb, and finally (v) the semantic contents of *kes* are the same as those of the NP head of the externally headed relative clause construction, .

An instance of the schematized lexical entry *kes* in the IHRC is as in (22), which is the lexical entry of *kes* in (1):

(22)

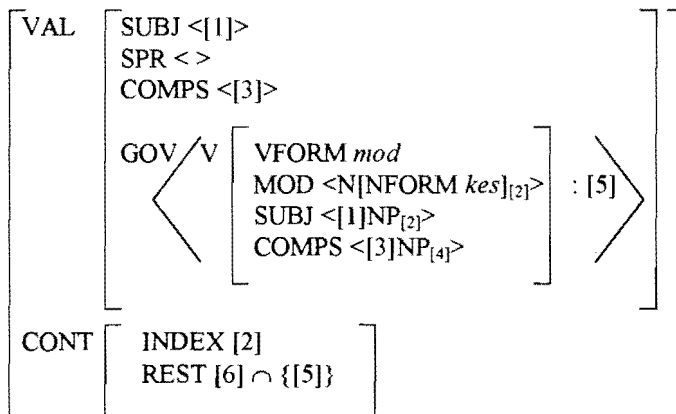

This lexical entry states the following: (i) *kes* is coindexed with the subject of the adnominal verb, a thief, and (ii) the semantic contents of *kes* are roughly $\{x \mid \text{thief}(x) \cap \text{come-out-of}(x, \text{bank})\}$, and thus that the whole IHRC has the same semantic contents as those of the externally headed relative clause. On my complex-noun approach to the IHRC, the structure of sentence (1) is as in (23):³

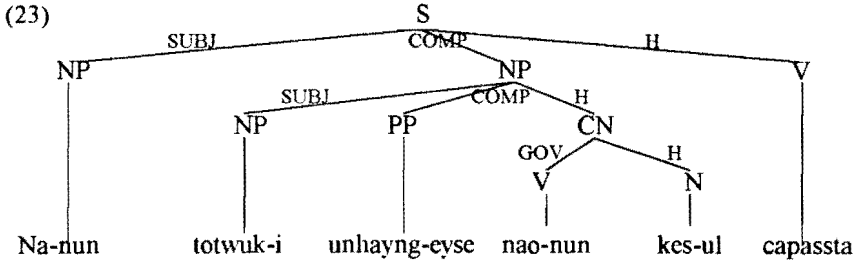

Here the adnominal verb *nao-nun* 'come from' and *kes* constitute a syntactic unit, namely a complex noun (CN henceforth). Note that here nominative case, not genitive case, is assigned to *totwuk* even though it is a sister to a noun. It is not problematic at all because the valence structure of *kes* is identical to that of the verb *nao-nun* due to argument composition.

In my analysis, the difference between the event reading and entity reading of the NP headed by *kes* (e.g., (1) and (5)) is accounted for by the existence and non-existence of argument composition. That is, when argument composition occurs, and when the expletive *kes* is coindexed with one of the raised arguments, the NP headed by *kes* has the entity reading. However, when argument composition does not occur, the whole NP headed by *kes* has the same semantics as its complement clause and takes a proposition as its semantic contents value.

On my approach, the subject-to-object raising fact (e.g., (8)) is accounted for in the following way. When the NP headed by *kes* is an element of the complement list of a physical action verb, which semantically cannot take a proposition as its argument, the NP headed by *kes* tends not to function as a "true" valent in some sense because *kes* in the IHRC is an expletive noun. Then its coindexed element (e.g., *totwuk* 'thief' in (8)) is allowed to be raised to the matrix valence list to become a true valent. This assumption is supported by the fact that a perception matrix verb does not trigger the raising:

- (24) Na-nun totwuk-i/*ul unhayng-eyse nao-nun kes-ul
 I-Top thief-Nom/Acc bank-from come-out-Mod entity-Acc
 alachayssta.
 noticed
 'I noticed that a thief was coming out of the bank.'

To describe the raising fact, this paper assumes the IHRC raising lexical rule in (25):

(25) IHRC Raising Lexical Rule:

phys-action [VAL | COMPS <NP[NFORM *kes*]_[3]>]

⇓

$$\left[\text{VAL} \mid \text{COMPS} \left\langle \text{N}' \left[\begin{array}{l} \text{NFORM } \textit{kes} \\ \text{SUBJ } \langle [1]_{[3]} \rangle \\ \text{COMPS } \langle \rangle \end{array} \right] \right\rangle \oplus \langle [1] \rangle \right]$$

Where $\langle X \rangle \oplus \langle Y \rangle = \langle X, Y \rangle$

The lexical rule in (25) states the following: (i) a physical-action verb that takes as its complement an NP headed by *kes* also takes an N' as its complement, and (ii) the subject of N', which is coindexed with the NP headed by *kes*, is list appended to the COMPS list of the physical action verb, i.e., the subject of a complement NP headed by *kes* is raised to a complement of the matrix verb when the subject is understood as a complement of the matrix verb.

According to this analysis, the structure of the raised sentence in (8) is as in (26):

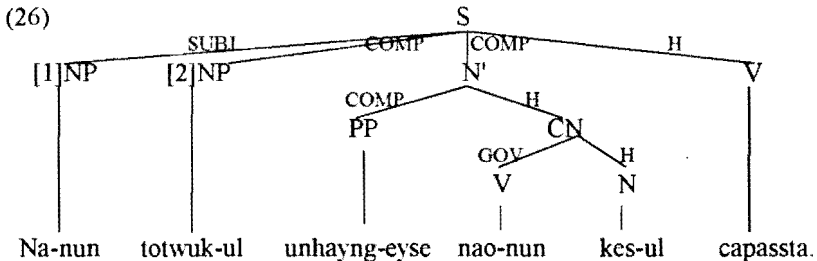

We may consider (26) as a nominal version of the raising construction of the *believe*-type verb, where [2]NP and N' correspond to the raised NP and VP in

the *believe*-type construction, respectively. Here the crucial mechanism is again argument composition which attracts the subject of the IHRC, *totwuk* 'thief' into a complement of the matrix verb, *capassta* 'caught.'

My analysis naturally accounts for the fact that the argument of the matrix verb is not *pro* (e.g., (12)) because in my analysis the argument position is already occupied by the NP headed by *kes*.

In the following section, some discourse facts involved in the IHRC construction will be discussed.

4 Contrastive Focus and Discourse Properties of the IHRC

One of the well-known discourse properties of the IHRC construction is that it is not appropriate as an answer to a *wh*-question (Park (1994), Ohara (1996), and Kim (1996) among others). The example is in (27):

- (27) A: Ne-nun nwukwu-lul capass-ni?
 you-Top who-Acc caught-Q
 'Who did you arrest?'
 B: a. Na-nun unhayng-eyse nao-nun totwuk-ul capassta.
 I-Top bank-from come-out-Mod thief-Acc caught
 'I arrested the thief who was coming out of the bank.'
 b. #Na-nun totwuk-i unhayng-eyse nao-nun
 I-Top thief-Nom bank-from come-out-Mod
 kes-ul capassta.
 KES-Acc caught

According to Ohara (1996), (27b) is awkward since the IHRC represents background information and is not good for an answer to a *wh*-question which needs to carry new information.

Kuroda (1976) and Kim (1996) point out another discourse-related property of the IHRC. An example is in (28):

- (28) a. Mary-nun tosekwan-eyse ilha-nun tongsayng-ul Conglo-eyse
 M-Top library-in work-Mod brother-Acc Chongro-on
 mannassta.
 met
 'Mary met in Chongro his bother who worked in a library.'

b. #Mary-nun tongsayng-i tosekwan-eyse ilha-nun kes-ul
 M-Top brother-Nom library-in work-Mod KES-Acc
 Conglo-eyse mannassta.
 Chongro-on met

According to Kim, the IHRC construction must have some spatio-temporal relationship between the events represented by the IHRC and by the matrix clause (or the matrix verb). And (28b) is awkward because this relationship does not exist there: the event of working occurs in a library, while the event of meeting occurs on Chongro Street.

The goal of this section is to provide a unified account of the given facts, based on the assumption that the IHRC is a type of the focus construction where the adnominal verb bears contrastive focus. That is, the contrastive reading involved with sentence (1) is "I arrested a thief when he was coming out of the bank, but not when he was in the bank."

According to Kiss (1998), contrastive focus (identificational focus in his terms) is usually involved with a specific syntactic construction. If this claim is correct, it is reasonable to assume that the IHRC construction involves contrastive focus since it is a syntactic-structure oriented focus.

Besides, if the IHRC construction is assumed to be the contrastive focus construction, we can account for the facts mentioned above in a uniform way. As well-known, contrastive focus differs from information focus in that the former represents a subset of the set of contextually given elements (i.e., presupposed or background information), while the latter represents totally new or non-presupposed information. Then the fact that the IHRC construction is not appropriate as an answer to a *wh*-question (e.g., (27)) is naturally accounted for since the answer to a *wh*-question must convey totally new information. Similarly, in English, the *it-that* cleft answer to a *wh*-question is not good since the clefted element carries contrastive focus.

The contrastive-focus approach can also account for the intuition on the IHRC construction that some logical or spatio-temporal relation exists between the events carried out by the IHRC and the matrix verb. In (28b), for example, the contrastive reading is "Mary met her brother on Chongro Street when he worked in a library, but not when he did something else." This is a very awkward contrastive reading because in the real world, it is hard to imagine a context where a person meets the other in a place (e.g., on Chongro Street) when the latter is in a different place (e.g., in a library). The externally headed relative clause example in (28a) is not awkward because it has a kind of generic reading rather than the contrastive reading, i.e., Mary met his brother who used to work in a library.

5 Conclusion

The main claims of this paper can be summarized as follows: (i) the constituent of "adnominal verb + *kes*" in IHRC needs to be considered as a complex noun, as the constituent of "verb + auxiliary verb" is considered as a complex predicate, (ii) argument composition (or raising in terms of GB) plays a crucial role in the analysis of the IHRC construction, and (iii) the IHRC construction is a syntactic-focus construction where the adnominal verb bears contrastive focus.

This paper also observes some parallelisms between verbal expressions and the IHRC construction:

(29) <u>verbal expression</u> complex predicate	<u>IHRC construction</u> complex noun ("adnominal verb + <i>kes</i> ")
subject-to-object raising in the <i>believe</i> -type construction	subject-to-object raising out of the IHRC

Presently, this paper cannot discuss in detail what the parallelisms suggest. However, it seems that they can be accounted for in a more general way if we assume the theory of the multiple inheritance of the construction types through the sort hierarchy, which is proposed in Sag (1997). See Chung (To appear) for more detailed accounts.

Notes

1. For some speakers, sentence (10) gets a little better when a definite determiner *ku*, which modifies *kes*, is located at the beginning of the parenthetical as shown in (i):

- (i) ???Na-nun totwuk-ul, [ku [khi-ka ku-n kes-ul]], capassta.
I-Top thief-Acc the height-Nom tall-Mod KES-Acc caught
'I arrested the thief who was tall.'

Even though (i) is marginally acceptable to some speakers, it seems that (i) cannot be considered as the same construction as (9) because *kes* in the IHRC can never be modified by a determiner as shown in (ii):

- (ii) *Na-nun totwuk-ul [ku [unhayng-eyse nao-nun kes-ul]] capassta.
I-Top thief-Acc the bank-out-of come-out-Mod KES-Acc caught
'I arrested the thief who was coming out of the bank.'

2. The sort *index* has two subsorts in Korean, *referential* and *kes*. The latter represents an expletive and is assumed to carry the head feature NFORM which was used in the earlier version of HPSG and GPSG.

3. Following Chung (1998), this paper assumes that Korean does not have the rule "S → NP VP" and thus that it has a flat clausal structure. According to Chung (1998), the head word combines first with its governee to constitute a complex word, and then the complex word combines with the subject and complements to constitute a phrase.

References

- Chung, C. 1998. "Argument composition and long-distance scrambling in Korean: an extension of the complex predicate analysis," *Complex Predicates in Nonderivational Syntax*, Syntax and Semantics, 30. New York: Academic Press. 159-220.
- _____. To appear. "Complex noun, multiple inheritance, and internally headed relative clause in Korean. *Berkeley Linguistics Society* 25.
- Chung, D. 1996. "On the structure of the so-called head internal relative construction," *Proceedings of the Pacific Asia Conference on Language, Information and Computation*, 11: 393-402.
- Haegeman, L., and H. van Riemsdijk. 1986. "Verb projection raising, scope, and the typology of rules affecting verbs," *Linguistic Inquiry*, 17: 417-466.
- Hinrichs, E., and T. Nakazawa. 1994. "Linearizing AUXs in German verbal complexes," *German in Head-Driven Phrase Structure Grammar*. Stanford: CSLI Publication. 11-37.
- Hoshi, K. 1994. "The head-internal relative clause in Japanese: an empty head noun approach," *Proceedings of the Japanese/Korean Linguistics Conference*, 5.
- Jhang, S.E. 1991. "Internally-headed relative clauses in Korean," *Harvard Studies in Korean Linguistics*, 4: 269-280.
- Kim, Y.B. 1996. "Internally headed relative clause constructions in Korean," *Proceedings of the Pacific Asia Conference on Language, Information and Computation*, 11: 403-413.
- Kiss, E. K. 1998. "Identificational focus versus information focus," *Language*, 74: 245-273.
- Kuroda, S. 1992. "Pivot-independent relativization in Japanese," *Japanese Syntax and Semantics: Collected Papers*. Dordrecht: Kluwer Academic Publishers. 114-174.
- Murasugi, K. 1994. "Head-internal relative clauses as adjunct pure complex NPs," *Synchronic and Diachronic Approaches to Language*. Tokyo: Liber Press.
- Ohara, K. H. 1996. *A Constructional Approach to Japanese Internally-Headed Relativization*. Ph.D. Dissertation. U.C. Berkeley.
- Park, B.S. 1994. "Modification vs. complementation: the so-called internally headed relative clauses reconsidered," *Proceedings of the 1994 Kyoto Conference: A Festschrift for Professor Akira Ikeya*. 41-48.
- Pollard, C. and I. Sag. 1994. *Head-Driven Phrase Structure Grammar*. Chicago: University of Chicago Press and Stanford: CSLI.
- Sag, I. 1997. "English relative clause constructions," *Journal of Linguistics* 33: 431-484.
- Uda, C. 1998. "A multiple inheritance analysis of the internally-headed relative clause in Japanese," *Proceedings of the Pacific Asia Conference on Language, Information and Computation*, 12: 82-93.

Reconsidering Weight Complementarity in Korean Partial Reduplication*

Chung, Chin Wan
Indiana University

1. Introduction

Ideophones in Korean exhibit both full and partial reduplication. There are several types of partial reduplication in Korean which include infixing partial reduplication, prefixing partial reduplication, and suffixing partial reduplication. Recent studies on partial reduplication in Korean have mainly been on infixing partial reduplication (Jun 1994, Davis and Lee 1994, 1996, Kim 1996, Chung 1997, 1998, and Kang 1998).

The main purpose of this study is to review Weight Complementarity (Suh, 1993) in Korean partial reduplication which prohibits an equal distribution of weight between the *copied portion* and the *original portion* in Suh's terms. Thus, if the copied portion is monomoraic (CV), then the original portion is bimoraic (CVC) and vice versa. This study argues that it is too strong to argue that weight complementarity applies to all types of partial reduplication in Korean ideophones because weight complementarity is observed only in infixing partial reduplication. It is not observed in prefixing and suffixing partial reduplication. Instead of relying on weight complementarity in partial reduplication, I provide an analysis for prefixing and suffixing partial reduplication within Optimality Theory (Prince and Smolensky, 1993), especially the advanced version of it named Correspondence Theory (McCarthy and Prince (henceforth M&P), 1995).

The organization of this study is as follows. In section 2, I explain weight complementarity in Korean partial reduplication with the data. In section 3, I present more data for Korean partial reduplication and problems that Suh's analysis may encounter. In section 4, I provide an analysis for prefixing, suffixing, and multiple partial reduplication which occurs with suffixing partial reduplication. I summarize the analysis in section 5.

2. Weight Complementarity in Korean partial reduplication

Suh (1993) argues that there is weight complementarity in Korean partial reduplication based on the assumption that coda consonants in reduplication processes are moraic while they are not in other processes of Korean, which could be construed that Korean reflects dual aspects of weight with respect to coda consonants. Weight complementarity in reduplication refers to uneven distribution of weight between the copied portion (generally known as the reduplicant) and the original portion (roughly referring to a part of the base in the reduplication process) which are termed the UNIT. The data for Korean partial reduplication are presented in (1) and (2) in which the copied part is underlined and in boldface while the original portion is not in boldface but underlined.

(1) Prefixing partial reduplication (Suh, 1993)

Base	Redup.	Gloss
a. /tuŋsil/	→ [<u>tu</u> -tuŋsil]	'floating gently'
b. /təŋsil/	→ [<u>tə</u> -təŋsil]	'dancing springly'
c. /teku/	→ [<u>tek</u> -teku]	'rolling; rumbling' ¹
d. /kolu/	→ [<u>kol</u> -kolu]	'evenly'
e. /t'əl'im/	→ [<u>t'əl</u> -t'əl'im]	'indisposed; reluctant'
f. /pəsis/	→ [<u>pəs</u> -pəsis]	'estranged'
g. /pət'im/	→ [<u>pət</u> -pət'im]	'having a gap between the two ends'

(2) Suffixing partial reduplication²

Base	Redup.	Gloss
a. /culuk/	→ [culu- <u>lu-k</u>]	'dribbling; trickling'
b. /asak/	→ [asa- <u>sa-k</u>]	'with a crunch; crisping'
c. /holok/	→ [holo- <u>lo-k</u>]	'sipping; flapping'
d. /t'alitŋ/	→ [t'alit- <u>litŋ</u>]	'ting-ting'
e. /pulitŋ/	→ [pulit- <u>litŋ</u>]	'with a burr'
f. /p'atik/	→ [p'ati- <u>ti-k</u>]	'creaking; with a grating sound'
g. /allok/	→ [allo- <u>lo-k</u>]	'mottled; variegated'
h. /t'olok/	→ [t'olo- <u>lo-k</u>]	'rolling'
i. /k'olok/	→ [k'olo- <u>lo-k</u>]	'rumbling'

Suh claims that the partial reduplication of Korean tends to keep three moras in the UNIT. Thus, if the copied portion is CV, then the original portion is CVC and vice versa. Some of the examples for the three-mora weight restriction in the unit are given in (3).

(3)



To explain weight complementarity in Korean, he relies on prosodic templates (M&P 1986, 1990), which stipulate morphological templates in terms of prosodic structure. He employs prosodic templates to provide constituency such as CV and CVC as the reduplicative template. The possible reduplicative templates for Korean partial reduplication CV and CVC can be prosodically defined as a syllable. Thus, from the perspective of M&P (1986, 1990), the reduplicative templates CV and CVC of Korean are subject to the conditions on association to a template since they are prosodically defined templates. If they are not prosodically defined templates, or if templates do not belong to a prosodic constituent, they cannot be licensed as a reduplicative template. The following are required conditions on association to a template in Korean partial reduplication.

(4) Conditions on Association to a Template

- a. Template Satisfaction: Satisfaction of template constraint is obligatory and is determined by the principles of prosody, both universal and language specific. (M&P, 1990)
- b. Maximization of Association: Associate as many phonemic melody elements as possible. (M&P, 1986)
- c. Priority Clause: In case of conflict between (a) and (b), first satisfy the template, then maximize application. (Archangeli, 1991:252)

With respect to dual aspects of weight, Suh uses the syllable-internal grid structure of Hayes (1991) which says that moras form a kind of grid with the syllable and that the height of a column is dependent upon the sonority of the segment it is associated with (Hayes 1991). Thus, the CVC structure of Korean can be treated as both light and heavy depending on the processes involved, as presented in (5).

(5) CVC structure of Korean (Suh, 1993:159)

kap	‘casket’	
σ		
^		
μ		→ other processes
μ	μ	→ partial reduplication
^		
k	a	p

Processes other than partial reduplication treat CVC as light while processes of partial reduplication regard the CVC structure of Korean as being heavy. That is, the syllable coda consonants are treated as being moraic in partial reduplication while they are not in other processes in Korean.

The partial reduplication processes in Korean can be presented in (6) and (7) based on the conditions on association to a template given in (4) and the

syllable-internal grid structure given in (5). In this study, I will focus only on prefixing partial reduplication.

(6) /tuŋsil/ → [tu-tuŋsil] ‘floating gently’

Abbreviations: Pref=Prefixation(σ), Sat=Satisfaction, Max=Maximization, Ext=Extrasyllabic

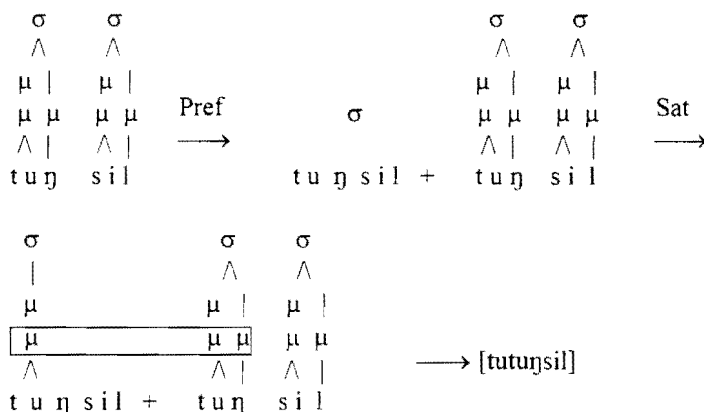

(7) /teku/ → [tekteku] ‘rolling; rumbling’

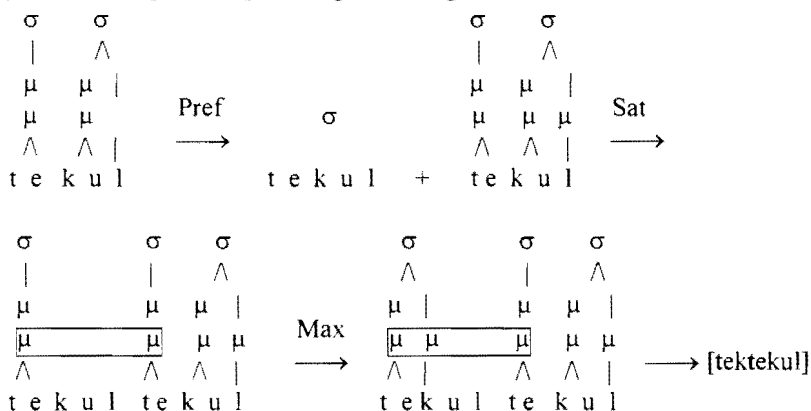

In (6), syllable prefixation is applied first and satisfaction should be applied in order to get three moras in the unit which is represented by the rectangular box. However, in (6) Maximization is not applied because the weight restriction in the unit is already satisfied. (7) exhibits another case of prefixing partial reduplication in Korean. In (7), syllable prefixation and satisfaction are applied just like in (6). But contrary to (6), Maximization must be applied in (7) to

satisfy the three-mora weight restriction in the unit. Thus, the application of the Maximization results in three moras in the unit as seen in (7).

As seen in this section, the data for Korean partial reduplication given in (1) and (2) reflect weight complementarity in reduplication processes. However, in the next section, providing additional data for prefixing and true suffixing partial reduplication, I will discuss problems that Suh's analysis may encounter.

3. Additional data and problems

In this section, I will provide additional data first for prefixing partial reduplication and then for suffixing partial reduplication. Prefixing partial reduplication in Korean ideophones duplicates the initial CVC of the base and can be viewed as being affixed leftward as seen in (8).³

(8) Prefixing partial reduplication

Base	Redup.	Gloss
a. /p'ək'uk/	→ [p'ək-p'ək'uk]	'cuckooing'
b. /paŋsil/	→ [paŋ-paŋsil]	'smile sweetly'
c. /t'olmaŋ/	→ [t'ol-t'olmaŋ]	'rolling (eyeballs)'
d. /pəllim/	→ [pəl-pəllim]	'quivering'
e. /təŋkɪləta/	→ [təŋ-təŋkɪləta]	'most imposing'

In this process, the laryngeal feature (fortis or aspiration) of base consonants is also duplicated on the reduplicant as in (8a) and (8c). But notice that the laryngeal feature of C₂ of the base consonant in (8a), which is the onset of the second syllable of the base, is not realized on the reduplicant when it is resyllabified as the coda in the reduplicant.

If weight complementarity is applied to the prefixing partial reduplication data given in (8b-e), then the reduplicant (Suh's copied portion) should consist only of CV since the initial syllable of the base (Suh's original portion) is CVC. However, the reduplicant of each datum actually consists of CVC. This is a violation of the three-mora weight restriction in the unit as illustrated in (9).

(9) Weight restriction in the unit

<div style="border: 1px solid black; display: inline-block; padding: 2px;"> μ μ μ μ </div>	<div style="border: 1px solid black; display: inline-block; padding: 2px;"> μ μ μ μ </div>
p a ŋ - p a ŋ s i l	p ə l - p ə l l i m

As shown in (9), the distribution of weight between the copied portion and original portion violate weight complementarity. Thus, weight complementarity is not consistently observed in prefixing partial reduplication. If we assume the prosodic structure of the reduplicant for prefixing reduplication is the initial CVC, then we can account for the data given in (1) and (8) unificdely.

Suffixing partial reduplication in Korean ideophones duplicates the final syllable of the base and the reduplicant is viewed as being affixed at the right edge of the base. I divide the data for suffixing partial reduplication into two groups. One group belongs to the data that end with a light final syllable and the other to the data with a heavy final syllable. Thus, the prosodic structure of the reduplicant for suffixing reduplication is either CV or CVC depending on whether the final syllable of the base is light or heavy as shown by the data in (10) and (11).

(10) Suffixing partial reduplication with a light final syllable

Base	→	Redup.	Gloss
a. /salɪɪ/	→	[salɪɪ-ɪ]	'softly'
b. /pusisi/	→	[pusisi-si]	'quietly'
c. /ac ^h a/	→	[ac ^h a-c ^h a]	'gee'
d. /əmə/	→	[əmə-mə]	'oh'
e. /ɬasc ^h a/	→	[ɬasc ^h a-c ^h a]	'pumping up'
f. /p'olɪɪ/	→	[p'olɪɪ-ɪ]	'bubbling'
g. /ɪsɪsi/	→	[ɪsɪsi-si]	'shivering'
h. /ciwhaca/	→	[ciwhaca-ca]	'corresponding to hand clapping'
i. /ususu/	→	[ususu-su]	'sound of falling leaves'

(11) Suffixing partial reduplication with a heavy final syllable

Base	→	Redup.	Gloss
a. /kuŋc'ak/	→	[kuŋc'ak-c'ak]	'rhythmic sound'
b. /s'akt'uk/	→	[s'akt'uk-t'uk]	'chopping'
c. /əlt'əlt'əl/	→	[əlt'əlt'əl-t'əl]	'perplexed'
d. /watan ^h aŋ/	→	[watan ^h aŋ-t ^h aŋ]	'clattering'
e. /utaŋ ^h aŋ/	→	[utaŋ ^h aŋ-t ^h aŋ]	'banging'
f. /wacəŋ ^h aŋ/	→	[wacəŋ ^h aŋ-c ^h aŋ]	'clashing'

It is obvious that the suffixing partial reduplication data given in (10) and (11) do not reflect weight complementarity between the copied and original portions. The weight restriction in the unit is violated in (10) since the number of mora in the unit in (10) counts only two, one short of the required mora in it. The weight restriction in the unit in (11) is not observed either. The number of mora in each datum is four. The violation of weight restriction in (10) and (11) is illustrated in (12).

(12) Weight restriction in the unit

<div style="display: inline-block; border: 1px solid black; padding: 2px;">μ</div> <div style="display: inline-block; border: 1px solid black; padding: 2px; margin-left: 10px;">μ</div>	<div style="display: inline-block; border: 1px solid black; padding: 2px;">μ</div> <div style="display: inline-block; border: 1px solid black; padding: 2px; margin-left: 5px;">μ</div> <div style="display: inline-block; border: 1px solid black; padding: 2px; margin-left: 5px;">μ</div> <div style="display: inline-block; border: 1px solid black; padding: 2px; margin-left: 5px;">μ</div>
<div style="display: inline-block; width: 10px; height: 10px; border: 1px solid black; margin: 0 auto;"></div> <div style="display: inline-block; width: 10px; height: 10px; border: 1px solid black; margin: 0 auto; margin-left: 10px;"></div>	<div style="display: inline-block; width: 10px; height: 10px; border: 1px solid black; margin: 0 auto;"></div> <div style="display: inline-block; width: 10px; height: 10px; border: 1px solid black; margin: 0 auto; margin-left: 5px;"></div> <div style="display: inline-block; width: 10px; height: 10px; border: 1px solid black; margin: 0 auto; margin-left: 5px;"></div> <div style="display: inline-block; width: 10px; height: 10px; border: 1px solid black; margin: 0 auto; margin-left: 5px;"></div>
c i w h a c a - <u>c a</u>	s' a k t' u k - <u>t' u k</u>

As seen in this section, weight complementarity is not consistently reflected in prefixing partial reduplication. Furthermore, it is not at all observed in suffixing partial reduplication.

In the next section, I will provide an analysis for prefixing, suffixing, and multiple partial reduplication. The multiple partial reduplication is found only with suffixing partial reduplication.

4. Analysis

In this section, I will provide an analysis within Correspondence Theory (M&P, 1995). First, I will propose constraints and their interaction for each type of reduplication. I begin with prefixing partial reduplication and suffixing partial reduplication. Then the analysis for the suffixing type of reduplication will be extended in order to account for multiple partial reduplication.

4.1 Prefixing partial reduplication

To analyze prefixing partial reduplication, which reduplicates the initial CVC of the base, I have employed the constraints given in (13).

(13) Constraints for prefixing partial reduplication

- a. $Afx \leq \sigma$ (M&P 1994, Urbanczyk 1995)
The phonological exponent of an affix is no larger than a syllable.
- b. MAX-BR: Every segment of the base has a correspondent in the reduplicant.⁴
- c. NoCoda: Syllables are open.
- d. IDENT-IO (Larynx): The laryngeal feature (fortis or aspiration) is identical in corresponding segments between the input and output.
- e. IDENT-BR (Larynx): The laryngeal feature of the base is identical in corresponding segments in the reduplicant.
- f. Coda Con: In coda position, only plain consonants are allowed.
- g. Anchor-L: The left edge of the base and reduplicant contains the same element.
- h. Anchor-R: The right edge of the base and reduplicant should share the same element.

In an Optimality-Theoretic perspective, full reduplication occurs if MAX-BR, which calls for a complete copy between the base and the reduplicant, is undominated. Partial reduplication results in if MAX-BR is violated under pressure from some higher ranked constraint(s). Since in prefixing partial reduplication in Korean, only the initial CVC of the base is copied, the MAX-

BR constraint is violated because some base segments do not have their correspondents in the reduplicant.

The size of the reduplicant is regulated by the undominated $Afx \leq \sigma$ constraint along the interaction with MAX-BR and NoCoda. MAX-BR is ranked lower than $Afx \leq \sigma$ because $Afx \leq \sigma$ takes precedence over MAX-BR. MAX-BR, in turn, should dominate the markedness NoCoda constraint to confine the prosodic structure of the reduplicant to CVC. If the ranking between them is reversed, a form which duplicates the initial CV of the base will wrongly be selected as the optimal form. The constraint interaction among $Afx \leq \sigma$, MAX-BR, and NoCoda is illustrated in the constraint table (14).

(14) $Afx \leq \sigma \gg$ MAX-BR \gg NoCoda

/RED+teku/	$Afx \leq \sigma$	MAX-BR	NoCoda
a. t'e-t'ekul		***!	*
b. t'ek-t'ekul		**	**
c. t'eku-t'ekul	*!	*	*

In (14), (a) is not the optimal form because it violates MAX-BR to a greater extent than the actual optimal form (b). (c) fares better on MAX-BR and NoCoda than the optimal form (b) but it does that at the cost of violating the undominated $Afx \leq \sigma$. Thus, (b) emerges as the winning output in (14).

With respect to copying laryngeal features, prefixing partial reduplication copies any laryngeal feature of the base consonants on the reduplicant. But if the coda consonant of the reduplicant copies the laryngeal feature of the base consonants, the laryngeal feature does not appear on the reduplicant because any laryngeal feature is not allowed in the coda position in Korean. Three Optimality-Theoretic constraints Coda Con, IDENT-IO (Laryn), and IDENT-BR (Laryn) are responsible for this.

Coda Con and IDENT-IO (Laryn), which do not show any particular ranking between them, are undominated in prefixing reduplication. These two undominated constraints are ranked higher than IDENT-BR (Laryn). If IDENT-BR (Laryn) is ranked higher than Coda Con and IDENT-IO (Laryn), on the one hand the constraint ranking will wrongly select a form with the reduplicant that has laryngealized coda consonants even at the expense of violating Coda Con. On the other hand, the ranking will incorrectly pick a form with the reduplicant that does not have any laryngeal feature. This means that in order to satisfy the high ranked IDENT-BR (Laryn) the laryngeal feature of the input consonants is not realized in the correspondents in the output violating IDENT-IO (Laryn). This ranking relation is illustrated in (15).

(15) Coda Con, IDENT-IO (Laryn) » IDENT-BR (Laryn)

/RED+p'ək'uk/	Coda Con	IDENT-IO (Laryn)	IDENT-BR (Laryn)
a. p'ək'-p'ək'uk	*!		
b. pək-p'ək'uk			**!
☞ c. p'ək-p'ək'uk			*
d. p'ək-p'əkuk		*!	
e. pək-pəkuk		*!*	

(a) is not the optimal form since it violates the undominated Coda Con. (b) is not the optimal form either because it has one more violation of IDENT-BR (Laryn) than (c). (d) and (e) fare better on IDENT-BR (Laryn) than (c) but neither of them is the optimal output because they satisfy IDENT-BR (Laryn) only at the cost of violating the higher ranked IDENT-IO (Laryn) once and twice each. Thus, candidate (c) emerges as the best output in (15).

Regarding the affixation of the reduplicant in reduplication, anchoring constraints can stipulate the direction of the affixation; Anchor-L ensures the prefixation of the reduplicant and Anchor-R requires the suffixation of the reduplicant to the base. Since this is prefixing reduplication, Anchor-L must dominate Anchor-R as illustrated in (16).

(16) Anchor-L » Anchor-R

/RED+t'əl'im/	Anchor-L	Anchor-R
☞ a. t'əl-t'əl'im		*
b. l'im-t'əl'im	*!	

So far the crucial constraint relation for prefixing reduplication has been established in the constraint tables in (14), (15), and (16). The very high ranked constraints such as $Afx \leq \sigma$, Coda Con, IDENT-IO (Laryn), and Anchor-L do not show any ranking among them. The overall constraint ranking for prefixing reduplication in Korean ideophones is given in (17).

(17) Overall constraint ranking for prefixing partial reduplication

<u>$Afx \leq \sigma$</u>	<u>Coda Con, IDENT-IO (Laryn)</u>	<u>Anchor-L</u>
<u>MAX-BR</u>	<u>IDENT-BR (Laryn)</u>	<u>Anchor-R</u>
<u>NoCoda</u>		

4.2 Suffixing partial reduplication

Suffixing partial reduplication in Korean duplicates the final syllable of the base and the reduplicant is affixed at the right edge of the base. In this process, any laryngeal feature of the base consonants is also duplicated on the corresponding segments on the reduplicant. The constraints for this type of reduplication are given in (18).

(18) Constraints for suffixing reduplication

- a. $Afx \leq \sigma$ (M&P 1994, Urbanczyk 1995)
The phonological exponent of an affix is no larger than a syllable.
- b. MAX-BR: Every segment of the base has a correspondent in the reduplication.
- c. NoCoda: Syllables are open.
- d. IDENT-IO (Laryn): The laryngeal feature (fortis or aspiration) is identical in corresponding segments between the input and output.
- e. IDENT-BR (Laryn): The laryngeal feature of the base is identical in corresponding segments in the reduplicant.
- f. *Laryngeal: Laryngeal feature (fortis or aspiration) is not allowed.
- g. Anchor-L: The left edge of the base and reduplicant contains the same element.
- h. Anchor-R: The right edge of the base and reduplicant should share the same element.

As seen in the previous section, the prosodic shape of the reduplicant for suffixing reduplication is CV or CVC. Since the reduplicant is maximally a syllable, $Afx \leq \sigma$ is undominated in this type of reduplication. To properly narrow down the reduplicant to CV or CVC, $Afx \leq \sigma$ must dominate MAX-BR. If MAX-BR is ranked over $Afx \leq \sigma$, the result is complete reduplication. MAX-BR should dominate NoCoda otherwise an output with the CV reduplicant will always be selected as the optimal form for the base with a heavy final syllable. Accordingly, NoCoda does not play an important role for the base with a light final syllable because in such cases NoCoda will be satisfied trivially. This is illustrated in the constraint tables in (19) and (20).

(19) $Afx \leq \sigma \gg \text{MAX-BR} \gg \text{NoCoda}$

/utəŋt ^h əŋ+RED/	$Afx \leq \sigma$	MAX-BR	NoCoda
a. utəŋt ^h əŋ-t ^h əŋ		****	***
b. utəŋt ^h əŋ-təŋt ^h əŋ	*!	*	*****
c. utəŋt ^h əŋ-t ^h a		*****!	**

(20)

/ac ^h a+RED/	Afx _≤ σ	MAX-BR	NoCoda
a. ac ^h a-ac ^h a	*!		
☞ b. ac ^h a-c ^h a		*	
c. ac ^h a-a		*!*	

With respect to the duplication of the laryngeal feature of the base consonants on the reduplicant, IDENT-IO (Laryn) and IDENT-BR (Laryn), which do not show any crucial ranking between them, must dominate *Laryngeal. If *Laryngeal is ranked over IDENT-IO (Laryn) and IDENT-BR (Laryn), the ranking will wrongly select an output without any laryngeal feature in the base and reduplicant. This ranking relation is illustrated in the constraint table (21).

(21) IDENT-IO (Laryn), IDENT-BR (Laryn) » *Laryngeal

/əlt ^h əlt ^h əl+RED/	IDENT-IO (Laryn)	IDENT-BR (Laryn)	*Laryngeal
☞ a. əlt ^h əlt ^h əl-t ^h əl			***
b. əlt ^h əlt ^h əl-təl		*!	**
c. əlt ^h əltəl-təl	*!		*
d. əltəltəl-təl	*!*		

In (21), (b) and (c) are not the optimal forms since they violate the undominated IDENT-BR (Laryn) and IDENT-IO (Laryn) once each. (d) satisfies *Laryngeal and IDENT-BR (Laryn) but it does that at the cost of violating IDENT-IO (Laryn) which (a) satisfies. Thus, candidate (a) emerges as the best output in (21).

The direction of affixation for this type of reduplication can be accounted for by ranking Anchor-R over Anchor-L because this is a suffixing type of reduplication in which the reduplicant is viewed as being affixed rightward. The ranking relation between two anchoring constraints is given in (22).

(22) Anchor-R » Anchor-L

/kuŋc ^h ak+RED/	Anchor-R	Anchor-L
☞ a. kuŋc ^h ak-c ^h ak		*
b. kuŋc ^h ak-kuŋ	*!	

So far we have established the crucial constraint ranking for suffixing reduplication in the tables (19), (21), and (22). The high ranked constraints such as Afx_≤σ, IDENT-IO (Laryn), IDENT-BR (Laryn), and Anchor-R do not show any important ranking among them. The combined overall ranking for this type of reduplication is given in (23). This ranking can account for bases ending with a light or heavy syllable.

(23) Overall ranking for suffixing partial reduplication

<u>Afx$\leq$$\sigma$</u>	<u>IDENT-IO (Laryn)</u> , <u>IDENT-BR (Laryn)</u>	<u>Anchor-R</u>
<u>MAX-BR</u>	<u>*Laryngeal</u>	<u>Anchor-L</u>
<u>NoCoda</u>		

4.3 Multiple partial reduplication

Multiple partial reduplication duplicates the final syllable of the base repeatedly. This type of reduplication occurs with suffixing partial reduplication but not with prefixing partial reduplication. All the data for suffixing partial reduplication given in the previous subsection can undergo multiple partial reduplication. The output forms in this type of reduplication usually have a connotation of repeated continuous action. Some of the examples for multiple partial reduplication are given in (24).

(24) Multiple partial reduplication⁵

Base	Multiple Redup.	Gloss
a. /ac ^h ac ^h a /	→ [ac ^h a c ^h a-...-c ^h a]	‘gee’
b. /əməmə/	→ [əməmə-...-mə]	‘oh’
c. /kuŋc ^h akc ^h ak /	→ [kuŋc ^h akc ^h ak -...-c ^h ak]	‘rhythmic sound’
d. /utaŋt ^h aŋt ^h aŋ/	→ [utaŋt ^h aŋt ^h aŋ-...-t ^h aŋ]	‘banging’
e. /wacəŋc ^h aŋc ^h aŋ/	→ [wacəŋc ^h aŋc ^h aŋ-...-c ^h aŋ]	‘clashing’

Since multiple partial reduplication occurs only with suffixing reduplication, I will employ the same constraint ranking used for the analysis of the single suffixing partial reduplication given in (23). The only difference between single and multiple partial reduplication lies on the input form. I assume that the base of the multiple partial reduplication mirrors an output and output relation with the singly reduplicated form. Thus, the singly reduplicated form [əmə-mə] ‘oh’ serves as the input of [əməmə-mə], and this output form can serve as input to an ensuing reduplication [əməməmə-mə], the output of which now can serve as input to a subsequent reduplication. Other than this difference, the single partial and multiple partial reduplication display the same reduplication processes. Since this is the case, I will extend the analysis of suffixing partial reduplication offered in 4.2 to multiple partial reduplication. This is illustrated in the constraint table (25) in which the undominated Afx \leq σ constraint and the low ranked constraints such as NoCoda and Anchor-L are not included.

(25) /ac^hac^ha' → [ac^hac^ha-c^ha] 'gee'

/ac ^h a c ^h a+RED/	Anchor-R	a. IDENT-IO (Laryn) b. IDENT-BR (Laryn)	a. MAX-BR b. *Laryngeal
a. ac ^h ac ^h a-ca		b*!	a*** b**
b. acaca-ca		a*!*	a***
c. c ^h a-ac ^h ac ^h a	*!		a*** b***
d. ac ^h ac ^h a-c ^h a			a*** b***

In (25), candidates (a) and (b) are not the optimal forms because they violate IDENT-BR (Laryn) and IDENT-IO (Laryn) once and twice respectively. (c) is not the optimal form either since it incurs the undominated Anchor-R by affixing the reduplicant at the left edge of the base. Thus, candidate (d) emerges as the optimal output.

The constraint ranking that is used for the analysis of the regular suffixing partial reduplication also can account for multiple partial reduplication.

5. Conclusion

In this study instead of relying on weight complementarity, I have proposed two constraint rankings within Correspondence Theory. One constraint ranking can account for prefixing partial reduplication which duplicates the initial CVC of the base. The other constraint ranking can account for the single and multiple suffixing partial reduplication unidely. The analysis offered in this study shows that weight complementarity in Korean partial reduplication is too strong since it is not observed in prefixing partial reduplication; it does not apply consistently in suffixing partial reduplication. Rather weight complementarity is observed only in infixing partial reduplication (Suh's suffixing partial reduplication data given in (2)).

Notes

*I am grateful for Byung-Jim Lim, Kwang-Chul Park, Minkyung Lee, and the audience of WECOL 98 for their comments. Especially, I would like to thank Stuart Davis for his critical comments. Of course any mistakes are my own.

¹ In Korean, when two obstruent consonants occur in syllable contact ($C_1\$C_2$), the second consonant should be tensified. Thus, the onset consonant of the original portion in (1c), (1f), and (1g) should be tensified.

² In this study I treat the data for suffixing partial reduplication given in (2) as a type of infixing partial reduplication (Davis and Lee, 1994, 1996), because there is a type of partial reduplication in Korean ideophones which can be viewed as true suffixation. In such types of reduplication, the final syllable of the base is copied and suffixed at the right edge of the base. This is discussed in section 3 and 4 in this study.

³ If we assume that the prosodic structure of the reduplicant for prefixing partial reduplication is CVC, then the prefixing data given in (1a) and (1b) raise a question for this assumption. However, these are the only data that have the CV reduplicant. It is difficult to classify those two forms as another type of prefixing partial reduplication. Thus, because of this paucity of data for the initial CV reduplication, I regard them as lexically marked reduplication (cf. Kang, 1998).

⁴ It is regarded in this study that each segment in the input form serves as the base for partial reduplication in Korean.

⁵ Multiple partial reduplication also occurs with infixing partial reduplication. In this reduplication process, the syllable core of the foot final syllable of the base is duplicated repeatedly (Chung, 1997).

References

- Archangeli, Diana. 1991. "Syllabification and prosodic template in Yawemani", *NLLT*, 9, 2: 231-283.
- Chung, Chin Wan. 1997. "A correspondence theoretic approach to partial reduplication in Korean", *Studies in the Linguistic Sciences*, 27, 1: 33-47.
- Chung, Chin Wan. 1998. "Fixed segmentism in Korean partial reduplication: three instances of the emergence of the unmarked", *The 11th International Conference on Korean Linguistics*: 272-281.
- Davis, Stuart and Jin-Seong Lee. 1994. "Infixal reduplication in Korean ideophones", *Japanese/Korean Linguistics*, 4: 447-461.
- Davis, Stuart and Jin-Seong Lee. 1996. "Korean partial reduplication reconsidered", *Lingua*, 99, 2/3: 85-105.
- Hayes, Bruce. 1989. "Compensatory lengthening in moraic phonology", *LI*, 20, 2: 253-307.
- Hayes, Bruce. 1991. "Metrical stress theory: Principles and case studies", ms., Los Angeles: UCLA.
- Jun, Jongho. 1994. "Metrical weight consistency in Korean partial reduplication", *Phonology*, 11, 1: 69-88.
- Kang, Ongmi. 1998. "A correspondence-theoretic analysis on Korean partial reduplication [in Korean]", To appear in *Journal of Korean linguistics*.
- Kim, June Soohee. 1996. "Emergence of the unmarked: Korean partial reduplication", *CLS*, 32: 179-189.
- Kim-Renaud, Young-Key. 1974/91. *Korean consonantal phonology*. Seoul: Hanshin Publishing Co.

-
- Marantz, Alec. 1982. "Re reduplication". *LI*, 13. 3: 453-482.
- McCarthy, John and Alan S. Prince. 1986. "Prosodic morphology", ms., University of Massachusetts, Amherst, and Brandeis University.
- McCarthy, John and Alan S. Prince. 1990. "Foot and word in prosodic morphology : the Arabic broken plural", *NLLT*, 8. 1: 209-284.
- McCarthy, John and Alan S. Prince. 1993a. "Prosodic morphology I: Constraint interaction and satisfaction", ms., University of Massachusetts at Amherst and Rutgers University.
- McCarthy, John and Alan S. Prince. 1993b. "Generalized alignment", In Green Booij and Jaap van Marle (eds.), *Yearbook of Morphology 1993*. Dordrecht: Kluwer, 79-154.
- McCarthy, John and Alan S. Prince. 1994. "Emergence of the unmarked: Optimality in prosodic morphology", *NELS*, 24: 333-379.
- McCarthy, John and Alan S. Prince. 1995. "Faithfulness and reduplicative identity", *UMOP*, 18: 249-384.
- Prince, Alan S. and Paul Smolensky. 1993. "Optimality theory: Constraint interaction in generative grammar", ms., Rutgers University, New Brunswick, and University of Colorado, Boulder.
- Suh, Chang-Kook. 1993. "Dual aspects of weight: evidence from Korean partial Reduplication", *WCCFL*, 12: 153-166.
- Urbanczyk, Suzanne. 1995. "Double reduplication in parallel", *UMOP*, 18: 499-532.

Chung, Chin Wan
Indiana University
Redbud Hills APTs #1606
Bloomington, IN 47408
cwchung@indiana.edu

Radically Local and Partial *wh*-movement in Madurese*

William D. Davies

University of Iowa

The present paper examines some constituent questions in Madurese and shows that the data cannot be analyzed as one might wish to at first glance—the kinds of analyses that have been proposed in the recent literature for Indonesian and Malay, two languages that Madurese is very closely related to. Despite widespread claims that Malay and Indonesian exhibit long-distance overt *wh*-movement and the fact that Madurese exhibits all the same properties identified in these languages, careful analysis of crucial data reveals that all overt *wh*-movement of arguments is radically local in the sense that only the subject in the clause immediately dominated by the *wh*-focus particle *se* may be questioned. I then go on to show that the proposed analysis explains certain apparently inexplicable facts concerning “partial *wh*-movement” in Madurese.

1. Basic Questions

The data in (1) and (2) illustrate the basic constituent question formation strategies in Madurese.

- (1) a. Siti maca apa?
S AF.read what
‘What did Siti read?’
b. Ali ngerem buku daq sapa?
A AF.send book to who
‘Who did Ali send a book to?’

* Thanks to Surachman and Sri Dimiyati for the Madurese data and judgments. I would like to thank Chris Culy and Stan Dubinsky for discussion of some of the issues and the data presented here and to audiences at the University of Iowa and WECOL for interesting questions and helpful discussion. Any errors or misapprehensions are mine alone. This work was supported in part by the National Science Foundation through grant no. SBR-9809044 to the University of Iowa.

- (2) a. Apa se e-baca Siti?
 what FOC OF-read S
 'What did Siti read?'
 b. Sapa se e-kerem Ali buku?
 who FOC OF-send A book
 'Who did Ali send a book to?'

In (1) we find *in situ* questions. In (2), we find the focus question strategy in which the *wh*-element has been clefted. It is these focus questions that give the appearance of *wh*-movement, and the main focus here will be on the focus strategy and the limitations placed on this movement. I follow Finer's (1997) proposal for Selayarese, analyzing the clefted questions as focus movement, the kind of analysis also proposed by Paul (1998) for Malagasy.

(3a) and (4a) give the appearance that Madurese has long-distance *wh*-movement in addition to the possibility of *wh-in situ* (3b) and (4b). Such data have led Cole and Hermon (1998), Saddy (1991), and others to propose Indonesian/Malay has long-distance *wh*-movement.

- (3) a. Sapa se e-kera Siti [e-pokol Hasan]?
 who FOC OF-think S OF-hit H
 'Who does Siti think Hasan hit?'
 b. Siti ngera [Hasan mokol sapa]?
 S AF.think H AF.hit who
 'Who does Siti think Hasan hit?'
 (4) a. Sapa se e-bala-aghi Hasan [jhaq e-tegguh Marlana]?
 who FOC OF-say-AGHI H COMP OF-see M
 'Who did Hasan say Marlana saw?'
 b. Hasan a-bala [jhaq Marlana negguh sapa]?
 H AF-say COMP M AF.see who
 'Who did Hasan say Marlana saw?'

A further possibility is what has been referred to as "partial *wh*-movement", that is, a structure in which a *wh*-element appears in clause-initial position in an embedded clause, so that it appears to have moved part way to the sentence-initial *wh*-position, as in (5).

- (5) Hasan a-bala [sapa se e-tegguh Marlana]?
 H AF-say who FOC OF-see M
 'Who did Hasan say Marlana saw?'

The long-distance movement in (3a) and (4a) is illusory, however. But to understand why we must briefly look at two aspects of Madurese verb morphology.

2. Madurese Verb Morphology

In Madurese there are three basic ways to package transitive predicates containing two bare arguments. The first sentence type, exemplified in (6), has been

characterized as the active, actor focus, actor topic, actor trigger, and others in the literature of closely related languages. This form is characterized by a word order of Actor-Verb-Theme and nasal morphology (as in the other Javanic languages) or the prefix *a-* for a number of predicates (cf. Stevens 1968 for a substantial list).

- (6) *Actor Focus*
 Burus jhuwa ngekeq Hasan.
 dog that AF.bite H
 'The dog bit Hasan.'

The sentence type in (7) is what has been called the passive, object focus, theme topic, patient trigger, object voice, and others.

- (7) *Object Focus*
 Hasan e-kekeq burus jhuwa.
 H OF-bite dog that
 'The dog bit Hasan./Hasan was bitten by the dog.'

In Madurese this is characterized by Theme-Verb-Actor order and the invariable prefix *e-*. The final variant (shared only by Malay/Indonesian) is another form frequently referred to as a passive, what Chung (1976) called the Preposed Object construction in Indonesian. As (8) shows, it is characterized by a Theme-Actor-Verb order and a bare stem form of the verb.

- (8) *Bare Stem*
 Hasan burus jhuwa kekeq.
 H dog that bite
 'The dog bit Hasan./Hasan was bitten by the dog.'

There are also two suffixes that play a crucial role in the analysis. Each suffix increases the valence of a verb, semantically or syntactically or both. The first suffix is *-aghi*. This suffix typically creates a causative or a benefactive predicate, depending on the valence of the stem. With intransitives, the resulting predicate is a causative, as in (9).

- (9) a. Kanaq jhuwa nanges.
 child that cry
 'The child cried.'
 b. Ali nanges-**aghi** kanaq.
 A cry-AGHI child
 'Ali made the child cry.'

With a transitive stem, the result of affixing *-aghi* is a benefactive clause, as in (10).

- (10) a. Siti maca buku.
 S AF.read book
 'Siti read the book.'
 b. Siti maca-**aghi** Ali buku.
 S AF.read-AGHI A book
 'Siti read Ali the book.'

The suffix *-e* is a bit more difficult to pin down precisely; however, its chief function is to create syntactically transitive structures from syntactically intransitive 2-argument predicates, as in (11b).

- (11) a. Siti entar daq Jakarta.
 S go to J
 ‘Siti went to Jakarta.’
 b. Siti ng-entar-e Jakarta.
 S AF-go-E J
 ‘Siti went to Jakarta.’

In (11b), the preposition *daq* is obligatorily omitted, *Jakarta* takes on the trappings of an object, and the verb takes the actor focus prefix. The important point here is that both of these suffixes extend the valence of the predicate to which they attach.

3. Revealing the Problems

The focus questions in (3a) and (4a) appear to involve *wh*-elements moved across a clause boundary. Why then claim that there is, in fact, no long-distance *wh*-movement? It would be easier to claim that there is, and it certainly would fit in with current popular theoretical assumptions. The problem is that such an analysis would leave too many facts unaccounted for. The fact is that it appears that long-distance *wh*-movement is unexpectedly blocked in a great number of cases.

For example, while the *in situ* question in (3b) is fully grammatical, the variety with the fronted *wh*-phrase is ungrammatical, (12).

- (3) b. Siti ngera [Hasan mokol sapa]?
 S AF.think H AF.hit who
 ‘Who does Siti think Hasan hit?’
 (12) *Sapa se Siti ngera [(jhaq) Hasan mokol]?
 who FOC S AF.think COMP H AF.hit
 (Who does Siti think that Hasan hit?)

Comparing the ungrammatical (12) with the grammatical counterpart with a fronted *wh*-element what we find in (3a), it is clear that one difference between the two is that in the ungrammatical question the verbs occur in the actor focus form, while in the grammatical question, the object focus form is used. In fact, it is also possible to form a grammatical question if the verbs are in the bare stem form or some combination of the bare stem and object focus form. The possibilities are shown in (13).

- (13) a. Sapa se Siti kera [Hasan pokol]?
 who FOC S think H hit
 ‘Who does Siti think Hasan hit?’
 b. Sapa se Siti kera [e-pokol Hasan]?
 who FOC S think OF-hit H
 ‘Who does Siti think Hasan hit?’

- c. Sapa se e-kera Siti [Hasan pokol]?
 who FOC OF-think S H hit
 'Who does Siti think Hasan hit?'

The facts are the same in Indonesian, Javanese, and Malay, and the Malay facts led Cole and Hermon to propose a constraint in Malay that prohibited actor focus morphology when a non-subject argument is extracted (this akin to the notion of *wh*-agreement proposed by Chung (1982) for Chamorro and Georgopoulos (1991) for Palauan). An analogue of this constraint is given in (14).

- (14) *Constraint on wh-movement*
 AF morphology is not possible on a verb over which *wh*-movement has occurred.

The constraint in (14) would block the kind of extraction that has been attempted in (12), thus ensuring that only the *wh*-in situ or the *wh*-focus with verbs in the object focus or bare stem forms is possible, that is, the grammatical questions in (3a) and (13).

However, such an analysis is challenged by the data in (15).

- (15) a. Siti yaken [(jhaq) Ali taho sapa]?
 S sure COMP A know who
 'Who is Siti sure that Ali knows?'
 b. *Sapa se Siti yaken [(jhaq) Ali taho]?
 who FOC S sure COMP A know
 (Who is Siti sure that Ali knows?)
 c. Sapa se e-yaken-e Siti [(jhaq) e-taho-e Ali]?
 who FOC OF-sure-E S COMP OF-know-E A
 'Who is Siti sure that Ali knows?'

The data in (15) indicate that the absence of actor focus morphology is not sufficient to license the extraction of a nonsubject. If it were sufficient, (15b) should be grammatical. But the correct form is (15c), in which both the matrix and embedded verbs occur in the object focus form and take the *-e* suffix. We return to the analysis of the correct form below.

Of course, it is possible that *yaken* 'sure' and *taho* 'know' are lexical exceptions. The fact is though that the inability to extract certain elements is quite robust. The data in (16) and (17) show additional examples.

- (16) a. Hasan a-bala [jhaq Marlana negguh sapa]?
 H AF-say COMP M AF.see who
 'Who did Hasan say Marlana saw?'
 b. Sapa se e-bala-aghi Hasan [jhaq e-tegguh Marlana]?
 who FOC OF-say-AGHI H COMP OF-see M
 'Who did Hasan say Marlana saw?'
 c. Sapa se Hasan bala-aghi [jhaq e-tegguh Marlana]?
 who FOC H say-AGHI COMP OF-see M
 'Who did Hasan say Marlana saw?'

- d.*Sapa se Hasan bala [jhaq Marlana tegguh]?
 who FOC H say COMP M see
 (Who did Hasan say Marlana saw?)
- e.*Sapa se Hasan bala [jhaq e-teguh Marlana]?
 who FOC H say COMP OF-see M
 (Who did Hasan say Marlana saw?)
- (17) a. Siti a-janji daq Ali [jhaq abaqeng melle-a apa]?
 S AF-promise to A COMP she AF.buy-IRR what
 ‘What did Siti promise Ali that she would buy?’
- b.*Apa se Siti janji daq Ali [(jhaq) e-belli-a abaqeng]?
 what FOC S promise to A COMP OF-buy-IRR she
 (What did Siti promise Ali that she would buy?)
- c. Apa se Siti janji-aghi daq Ali [(jhaq) e-belli-a
 abaqeng]?
 what FOC S promise-AGHI to A COMP OF-buy-IRR
 she
 ‘What did Siti promise Ali that she would buy?’

Looking only at the sentences in (16), we find that where we have acceptable cleft questions that appear to focus an embedded element, we must have the *-aghi* suffix on the matrix verb, as in (16b & c). Where the suffix is missing, the result is ungrammatical, as in (16d & e). The sentences in (17) are analogous.

The data in (16d,e) and (17b) again show that when questioning an embedded element via the focus strategy, it is insufficient to merely have the matrix verb in a non-actor focus form. It is also necessary to include the *-aghi* suffix (as in (16b,c) and (17c)) or the *-e* suffix (as in (15c)). As we have seen, these suffixes extend the valence of the base in some way; in the cases of *yaken* ‘sure’, *bala* ‘say’, and *janji* ‘promise’, these suffixes allow the addition of an “oblique” thematic argument which, as we shall see, actually acts as the direct object.

The question we must now address is what the role of this morphology is in these structures. The answer to this will provide the key to our analysis of apparent long-distance *wh*-movement in Madurese.

4. Toward a Solution

One peculiarity of the type of questions that we find in the grammatical focus questions in (15-17) is the fact that it is possible to have a “resumptive” pronoun in the embedded clause “gap”. This is illustrated in (18, 19). (This cannot be illustrated with an analogue of (17) because there are no pronominal forms used with inanimates.)

- (18) Sapa se e-yaken-e Siti [jhaq **abaqeng** e-taho-e Ali]?
 who FOC OF-sure-E S COMP s/he OF-know-E A
 'Who is Siti sure that Ali knows?'
 lit. 'Who is it that Siti is sure that Ali knows him/her?'
- (19) a. Sapa se e-bala-aghi Hasan [jhaq **abaqeng** e-tegguh Marlana]?
 who FOC OF-say-AGHI H COMP s/he OF-see M
 'Who did Hasan say Marlana saw?'
 lit. 'Who is it that Hasan said that Marlana saw him/her?'
- b. Sapa se Hasan bala-aghi [jhaq **abaqeng** e-tegguh Marlana]?
 who FOC H say-AGHI COMP s/he OF-see M
 'Who did Hasan say Marlana saw?'
 lit. 'Who is it that Hasan said that Marlana saw him/her?'

So what we find in these constructions is the admissibility of a pronominal form that is coreferent with the *wh*-phrase. This type of "resumptive" pronoun is not regularly available in questions, as illustrated in the ungrammatical examples in (20).

- (20) a. Sapa se (*abaqeng) Siti pokol?
 who FOC s/he S hit
 'Who did Siti hit?'
- b. Sapa se (*abaqeng) e-kerem-e Marlana buku?
 who FOC s/he OF-send-E M book
 'Who did Marlana send a book?'

The question now becomes, why the pronoun is acceptable in the questions in (18,19). The reason is that the matrix verbs actually take an additional argument, an argument which controls a pronominal element (most usually but not necessarily the subject) in the immediately embedded clause. Since pronouns are usually null in the language, when it's a question word that's doing the controlling, it has the appearance of being a gap. However, we can see the control structures outside of question and focus constructions in the examples in (21) and (22).

- (21) Siti ng-yaken-e Marlana, [jhaq abaqeng, e-taho-e Ali].
 S AF-sure-E M COMP she OF-know-E A
 'Siti is sure about Marlana that Ali knows her.'
- (22) Hasan a-bala-aghi Siti, [jhaq abaqeng, e-tegguh Marlana].
 H AF-say-AGHI S COMP she OF-see M
 'Hasan said about Siti that Marlana saw her.'

The pronominal forms actually could appear as the object of an actor focus verb in both (21) and (22), but it is more usual for the pronoun to appear in subject position. As the translations indicate, these structures are not unknown in English.

This, in turn, provides a key to one of the apparent cases of long-distance movement. Recall that Madurese has an *in situ* strategy for question formation. It turns out that it is possible to have *in situ* variants of (18) and (19).

- (23) Siti ng-yaken-e **sapa**, [jhaq (abaqeng,) e-taho-e Ali]?
 S AF-sure-E who COMP s/he OF-know-E A
 'Who is Siti sure that Ali knows?'
- (24) Hasan a-bala-aghi **sapa**, [jhaq (abaqeng,) e-tegguh Marlana]?
 H AF-say-AGHI who COMP s/he OF-see M
 'Who did Hasan say that Marlana saw?'

Thus, the questions in (18) and (19) are simply analogues of (23) and (24) in which the *wh*-phrase has been focused. I would thus propose that the question in (4a) has the approximate structure in (25).

- (25) [sapa_i se [[p t_i e-bala-aghi Hasan t_i [CP jhaq pro_i e-tegguh Marlana t_i]]]

In (25), *sapa* is never a constituent of the embedded clause but originates in the matrix clause and controls a null pronoun in the embedded clause. Thus, we find that there is no need to suppose that there is long-distance *wh*-movement involved in the derivation of this sentence (4a). We simply need to recognize the control-like structure.

The other apparent case of long-distance movement is more easily accounted for. The question is repeated here.

- (3) a. Sapa se e-*kera* Siti [e-pokol Hasan]?
 who FOC OF-think S OF-hit H
 'Who does Siti think Hasan hit?'

Recall that all of the possible questions with the *wh*-phrase in matrix focus position require that both verbs occur without actor focus morphology. What we have in this instance is a simple case of raising. Verbs such as *kera* 'think', *karepaghi* 'expect' and others are raising verbs in Madurese and closely related Austronesian languages. Cases of raising are given in (26).

- (26) a. Ali e-*kera* Siti [e-pokol Hasan].
 A OF-think S OF-hit H
 'Siti thinks that Ali was hit by Hasan.'
- b. Ali Siti *karepaghi* [ngecoq sepeda].
 A S expect AF.steal bicycle
 'Siti expects Ali to steal the bicycle.'

Naturally, the raised subjects in (26) can also be clefted, as in (27).

- (27) a. Ali se e-*kera* Siti [e-pokol Hasan].
 A FOC OF-think S OF-hit H
 'Ali is the one that Siti thinks was hit by Hasan.'
- b. Ali se Siti *karepaghi* [ngecoq sepeda].
 A FOC S expect AF.steal bicycle
 'Ali is the one that Siti expects to steal the bicycle.'

Thus the questions in (3a) and (13) can be analyzed simply as cases of raising to subject with subsequent focus movement, and (3a) be assigned the structure in (28).

- (28) [sapa_i se [[p t_i e-*kera* Siti [[p t_i e-pokol Hasan t_i]]]]

Now, when two raising predicates occur in contiguous clauses, it is possible to

have a structure that looks like really long-distance movement, as in (29).

- (29) Sapa se e-kera Siti [e-karepaghi Ali [ngecoq sepeda]]?
 who FOC OF-think S OF-expect A AF.steal bicycle
 'Who does Siti think Ali expects to steal the bicycle?'

However, should a non-raising predicate such as *kasta* 'regret' intervene, blocking raising, the apparent long-distance *wh*-movement is ungrammatical, as in (30).

- (30) *Sapa se e-kera Siti [Ali kasta [ngecoq sepeda]]?
 who FOC OF-think S A regret AF.steal bicycle
 (Who does Siti think Ali regrets stole the bicycle?)

In fact, it is when such movement is blocked that one case of apparent "partial" *wh*-movement occurs. This is illustrated in (31).

- (31) Siti ngera [Ali kasta [sapa se ngecoq sepeda]]?
 S AF.think A regret who FOC AF.steal bicycle
 'Who does Siti think Ali regrets stole the bicycle?'

A similar case is the question that illustrated partial *wh*-movement previously, repeated here.

- (5) Hasan a-bala [sapa se e-tegguh Marlana]?
 H AF-say who FOC OF-see M
 'Who did Hasan say Marlana saw?'

Movement into the higher clause is blocked because *bala* 'say' is not a raising predicate; thus, *sapa* can move no farther than into a focused position in the embedded clause. Thus the appearance of partial *wh*-movement can be explained by virtue of recognizing that all but the final movement is movement to an argument position. When movement to an argument position is blocked, movement must cease and the result resembles partial movement found in other languages.

5. Conclusion

The final insurmountable problem for the analysis that tries to promote long-distance *wh*-movement and maintain the kind of constraint in (14) as a partial explanation is the fact that there are counterexamples to the constraint against movement across AF morphology. An example is given in (32).

- (32) Sapa se e-bala-aghı Siti jhaq Hasan mokol anaq-eng?
 who FOC OF-say-AGHI S COMP H AF.hit child-DEF
 'Whose child did Siti say that Hasan hit?'
 lit. 'About whom did Siti say that Hasan hit his/her child?'

Here the possessor of the object of the embedded clause is coreferent with the matrix fronted *wh*-phrase and there is AF morphology on the embedded verb. Thus, (14) is quite explicitly counterexemplified and provides no viable account.

Once the special nature of the matrix verbs in question is recognized the need for a constraint such as (14) disappears along with the analysis that promotes the

notion of any but the most radically local type of *wh*-movement, limited to movement of the *wh*-element from the immediately dominated subject position. All other movement of arguments that takes place appears to be A-movement, a conclusion also reached for *wh*-arguments in Malagasy by Paul (1998) and a conclusion that may be applicable to some other closely related languages.

References

- Chung, Sandra. 1976. "On the Subject of Two Passives in Indonesian," *Subject and Topic*, ed. by C. Li. New York: Academic Press.
- Chung, Sandra. 1982. "Unbounded Dependencies in Chamorro Grammar," *Linguistic Inquiry* 13:39-77.
- Cole, Peter, and Gabriella Hermon 1998. "The Typology of WH Movement: WH Questions in Malay." *Syntax* 1:221-258.
- Finer, Daniel. 1997. "Contrasting A'-dependencies in Selayarese," *Natural Language and Linguistic Theory* 15:677-728.
- Georgopoulos, Carol. 1991. *Syntactic Variables, Resumptive Pronouns, and A-bar Binding in Palauan*. Dordrecht: Kluwer.
- Paul, Ileana. 1998. "Focus Movement and *wh*-Questions in Malagasy." Presented at WECOL 1998. This volume.
- Saddy, Douglas. (1991) "Wh Scope Mechanisms in Bahasa Indonesia," *MIT Working Papers in Linguistics* 15:183-218.
- Stevens, Alan. 1968. *Madurese Phonology and Morphology*. New Haven, CT: American Oriental Society.

William D. Davies
 Department of Linguistics
 University of Iowa
 Iowa City, IA 52242-1408
 william-davies@uiowa.edu

Onset Motivated Overcopy in Reduplication¹

Laura J. Downing

University of California-Berkeley

1. Introduction

A long-standing problem in Prosodic Morphology is how to formally account for the prosodically motivated overcopying which is frequently found when reduplicating vowel-initial Bases. A striking example of this is found in KiNande, a Bantu language spoken in Congo-Kinshasa. As Mutaka & Hyman (1990) and Mutaka (1994) have shown, the reduplicative prefix (RED) is always exactly two syllables long. Monosyllabic stems like those in (1b) double reduplicate to fill out the second syllable. The disyllabic vowel-initial stems in (1d) also double reduplicate, resulting in “overcopy”. The first problem posed by the overcopy forms is why one copy of the base is not sufficient to satisfy the disyllabic condition on the reduplicant, even though the base is disyllabic.

- (1) KiNande verbal reduplication (Mutaka & Hyman 1990; Mutaka 1994;
form of verbs is: infinitive prefix-(RED=)Stem; tones not marked)

<u>Stem</u>	<u>Reduplicated Form</u>	<u>Gloss</u>
(a) <i>Consonant-initial</i>		
eri-huma	eri- <u>huma</u> =huma	to beat
eri-humira	eri- <u>huma</u> =humira	to beat for
eri-humirana	eri- <u>huma</u> =humirana	to beat for each other
(b) <i>Monosyllabic</i>		
eri-swa	eri- <u>swa_swa</u> =swa	to grind
eri-ta	eri- <u>ta.ta</u> =ta	to bury
(c) <i>Vowel-initial, infixing</i>		
ery-esera	ery- <u>e=sera</u> =sera	to play for
ery-ohera	ery- <u>o=hera</u> =hera	to pick for
(d) <i>Vowel-initial, prefixing</i>		
ery-esa	ery- <u>e.se.s</u> =e.sa	to play
ery-oha	ery- <u>o.ho.h</u> =o.ha	to pick

A further challenge for a formal analysis of overcopy in KiNande is to explain why in related languages, like Kikuyu, which have a near identical reduplication pattern for consonant-initial stems (see (2a. b)), vowel-initial stems like those in (2c) satisfy the disyllabic minimality requirement on RED without overcopy.

(2) Kikuyu verbal reduplication (consonants in Kikuyu orthography; vowels in IPA; vowel sequences are long vowels or diphthongs; tones not marked; form of verbs is infinitive prefix-(RED=)Stem)²

<u>Infinitive</u>	<u>Reduplicated Form</u>	<u>Gloss</u>
(a) <i>Consonant-initial:</i>		
go-cama	go- <u>cama</u> =cama	'taste'
go-thuura	go- <u>thuura</u> =thuura	'choose'
ko-hetoka	ko- <u>heta</u> =hetoka	'pass'
ko-hetokana	ko- <u>heta</u> =hetokana	'pass ea. other'
(b) <i>Monosyllabic:</i>		
ko-go	ko- <u>goo.a</u> =goo.a	'fall'
ko-hea	ko- <u>hee.a</u> =hee.a	'be burnt'
(c) <i>Vowel-initial:</i>		
kw-ɛɛnya	kw- <u>ɛɛ.nyɛ</u> =ɛ.nyɛ	'run'
kw-aandeka	kw- <u>aa.nda</u> =a.ndeka	'write'
g-ookera	g- <u>oo.kɔ</u> =ɔ.kera	'wake up'
ko-inaina	ko- <u>i.na</u> =i.nai.na	'shiver'

I argue in this paper that overcopy is optimal in KiNande because it is the only way to satisfy the requirement that each syllable of the reduplicative foot be associated with a moraic element in the reduplicative string. To formalize this generalization, I propose that templatic constraints like RED=Ft must be split into two constraints, one evaluating the alignment and the other evaluating the weight of RED. As I show, this allows us to make explicit how the interaction of other constraints with the weight condition on RED accounts both for overcopy in KiNande and for why overcopy is not found in Kikuyu. Conflating weight and alignment conditions in a single constraint obscures these relations.

2. Consonant-initial Reduplicants in KiNande and Kikuyu

As background to my analysis of vowel-initial REDs in KiNande and Kikuyu, I will first develop an account of the consonant-initial REDs in these two languages. As we have seen in (1), REDs are prefixes to the verb stem in KiNande and are exactly two syllables long. Longer bases are only partially reduplicated; shorter bases are expanded to fill up a second syllable. As Peng has shown, the same size constraint holds for Kikuyu REDs illustrated in (2). I follow these authors in proposing that this size condition is accounted for by defining the RED string as a foot. This requirement is formalized in (3); (4) formalizes the requirement that the foot be minimally and maximally bimoraic:³

(3) RED=Ft

- (a) The RED string is coextensive with a foot;
- (b) The RED string is associated with the weight-bearing elements of a foot.
- (4) FtBin: Feet are minimally and maximally bisyllabic.

As work like that of McCarthy & Prince (1995) makes clear, constraints like those in (3) are understood to evaluate the prosodic well-formedness of RED

along two dimensions: alignment (this is the requirement in (3a) and prosodic weight (this is the requirement in (3b)). We can see that the REDs in (1a) and (2a) straightforwardly satisfy both of these conditions. These data also motivate ranking RED=Ft, FtBin above MAX B-R: REDs are never longer than two syllables no matter how long the Base is.

The monosyllabic stems in (1b, 2b) show that REDs must be disyllabic even when the Base is subminimal. In KiNande monosyllabic stems are expanded by double reduplication, in violation of Integrity (6a; Rose, to appear; McCarthy & Prince 1995). This is accounted for by ranking RED=Ft, FtBin above Integrity (6a). In Kikuyu, monosyllabic stems are expanded by lengthening the root vowel, forcing hiatus between the root vowel and final /a/ in both the Base and RED. If lengthening is a violation of *VV (6b), a constraint banning tautosyllabic vowel sequences, then ranking *VV below RED=Ft, FtBin optimizes lengthening to satisfy RED minimality.

(6)

(a) **Integrity**: No element of S1 has multiple correspondents in S2. (Rose, to appear; McCarthy & Prince 1995)

(b) ***VV**: No long vowels or diphthongs. (Rosenthal 1994)

The tableaux in (7) illustrate the analysis.⁴

(7)

(a) Exemplification of KiNande analysis, C-initial bases

eri-RED-humirana	RED =Ft	FtBin	*VV	Integri- ty	MAX B-R
(a) √ eri-(<u>huma</u>)= humirana					*
(b) eri-(<u>humirana</u>)= humirana		*!			
(c) eri-(<u>hu</u>)=humirana		*!			*
eri-RED-swa					
(d) √ eri-(<u>swaswa</u>)= swa				*	
(e) eri-(<u>swa</u>)=swa		*!			
(f) eri-(<u>soo.a</u>)-swa			*!		

(b) Exemplification of Kikuyu analysis, C-initial bases

ko-RED-hetokana	RED= Ft	FtBin	Integri- ty	*VV	MAX B- R
(a) $\sqrt{\text{ko-(heta)}}$ = hetokana					*
(b) ko-(<u>hetokana</u>)-hetokana		*!			
(c) ko-(<u>hc</u>)-hetokana		*!			
ko-RED-go					
(d) $\sqrt{\text{ko-(goo.a)}}$ =goo.a				*	
(e) ko-(<u>goa</u>)-go		*!			
(f) ko-(<u>goa.goa</u>)-go			*!		

Turning now to the infixing vowel-initial KiNande stems in (1c), we see that the infixing position of the RED after the stem-initial vowel has the usual advantage of improving the prosodic well-formedness of both the Base and the RED. Both are well aligned with optimal syllables; RED is a disyllabic foot. To account for the infixing position of RED in these forms, I follow Mutaka & Hyman (1990) and Mutaka (1994) in proposing that the stem initial vowel is extraprosodic: it is excluded from the base for reduplication because it does not begin a syllable. As argued in Downing (1998), extraprosodicity is best accounted for by adopting Inkelas's (1990, 1993) theory of prosodic misalignment. In this theory, phonological processes take morpho-prosodic constituents (P-constituents) as their domains. In the default case, P-constituents are coextensive with the morphological constituent on which they are based. But they may be misaligned to satisfy higher-ranked constraints. When the misalignment excludes some segments of the morphological constituent from the corresponding P-constituent, the excluded segments are by definition extraprosodic.

Within this theory, stem-initial vowels are made extraprosodic by the constraints in (8) and (9):

(8a) **Align P-Stem- σ (Stem)**: Align L (P-Stem, σ)

(8b) **Onset**: *AlignL (σ , μ_s)⁵

OUTRANK

(8c) **Align P-Stem** (default): M-Stem \approx P-Stem

The constraints in (8a, b) outrank the default P-Stem alignment constraint in (8c), making it optimal for the P-Stem to be aligned with a syllable edge rather than with the morphological stem (M-Stem) edge. Because a stem-initial vowel cannot begin a syllable (all word-medial syllables must begin with an onset in KiNande), the constraints in (8a,b) optimize misalignment of P-Stem with a vowel-initial M-Stem to improve the prosodic well-formedness of the P-Stem.

(Other constraints and rankings optimize infixation, not exfixation, in KiNande. See Downing (1998a,b) for discussion.)

To explain why REDs of the VCV stems in (1c) are prefixed, not infix, I follow Mutaka & Hyman (1990) in proposing that extraprosodicity is blocked if the resulting constituent would be sub-minimal. Ranking the P-Stem minimality constraint, Min (9), above Stem (8a) optimizes prefixing the RED of disyllabic stems:

(9) **Min:** The P-Stem must minimally contain two syllables.

The tableau in (10) shows how these constraints and constraint-rankings predict that the P-Stem will optimally exclude the M-Stem-initial vowel, subject to minimality.

(10)

	DEP I-O	RED =Ft	Ft Bin	Min	Integ	Onset	Stem
(a) √ ery=e+(sera)+[sera							
(b) * e(rye.sa)+[.e.sera		?				*!	
(c) * e(ry= <u>e</u> .s+[e].sera		?					*!
(d) * e(ry= <u>esa</u>)+[ye.sera	*!	?					
(e) √? e(ry= <u>e</u> .se).s+[e.sa		?			*		*
(f) * e(ry=(<u>e</u> .s+[e].sa		?					
(g) * e(ry= <u>esa</u>)+[yesa	*!	?					
(h) * ery=e+(sa.sa).+[sa				*!			
(i) √ eri=(swa.swa)+[swa				*	*		
(j) * eri=(swa)+[swa			*!	*			
(k) * eri=(swa)+[swaỵː	*!*		*				

As shown in (10a), it is optimal to satisfy Onset (8b) and Stem (8a) by making the initial vowel extraprosodic and infixing the reduplicant. However, in shorter vowel-initial stems (10e), it is optimal to violate Stem in order to satisfy Min (9). Making the initial vowel extraprosodic, as in (10h), violates Min, while competing candidates that satisfy Min (10f, g) violate higher ranked constraints. The monosyllabic stem in (10i) shows that subminimal PStems are tolerated

only when satisfying Min would come at the expense of violating DEP by epenthesis, as shown in (10k).

3. Problems with Conflating Weight and Alignment

Until now, the alignment and weight conditions defining RED=Ft appear to be redundant since all the C-initial REDs necessarily satisfy both. But the tableau in (10) shows that when REDs (and Bases) are V-initial the correct surface candidate (10e) cannot satisfy the alignment conditions on feet if feet are always aligned with syllable edges. Does it satisfy RED=Ft, then, or not?

The question marks in tableau (10) emphasize why it is crucial to resolve this problem. Notice that candidate (10f), which has only one copy of the base, is optimal if both it and the overcopy candidate, (10e), equally violate RED=Ft, because overcopy violates an additional constraint, namely, Integrity. However, in comparing (10e) and (10f), we can see that overcopy has the advantage over a single copy of allowing the RED string to better fill the RED foot: both syllables of the foot are associated with a moraic element of the RED string in (10e), but only one syllable of the foot is filled by the RED string in (10f).

We now have an answer to the question of what motivates overcopy in KiNande. Overcopy is the only means, given the other constraints and rankings of the language, to satisfy the weight conditions on the RED-Foot. But does the RED in (10e) satisfy RED=Ft, as we need it to in order to be optimal, if it satisfies the weight condition on feet but not the alignment condition?

Different authors provide different responses to this question. McCarthy & Prince's (1995) analysis of the Chumash reduplication data in (11) proposes that the reduplicative 'template' is a bimoraic syllable.

(11) Ineseño Chumash reduplication (Applegate 1976)

(a) C-initial stems

t huma]	t <u>hum</u> -t huma]	'islanders, Chumash people'
s-t eq]-t <u>eq</u> -t eq	'it is very torn'
]-texex']-t <u>ex</u> -texex'	'rivers'
skon	s- <u>kon</u> -kon'	'worms, reptiles'

(b) V-initial stems

k-ic'is	<u>kic</u> -kic'is'	'my sisters'
s-ikuk	<u>sik</u> -sikuk	'he is chopping'
s-i]-expet]]-i]- <u>ex</u> -]-expet]	'they two are singing'

In evaluating competing candidates, they crucially claim that candidate (12d), below, violates RED= $\sigma_{\mu\mu}$. The RED in this candidate is bimoraic and so satisfies the weight condition defined by this constraint. But because RED is misaligned with a syllable, it is still considered to violate the constraint.

(12) Chumash reduplication (adapted McCarthy & Prince 1995, p. 312, fig (80))

/s-RED-ikuk/	Anchor	IDENT-BR(F)	RED= $\sigma_{\mu\mu}$	DEP-IO	MorphDis
a. $\sqrt{\text{sik}}$ -s ikuk				*	*
b. <u>sik</u> -C ikuk	*!		*	*	
c. <u>sik</u> -C ikuk		*!		*	*
d. s <u>ik,k</u> -ikuk			*!		

However, Blevins's (1996) analysis of Mokilese reduplication takes a different view. Blevins follows McCarthy & Prince (1986) in proposing that the 'template' for the Mokilese reduplication pattern illustrated in (13) is a bimoraic syllable. In contrast to Chumash, gemination or overcopy of partial geminates, is the optimal strategy for resolving hiatus between a vowel-initial Base and a prefixed RED in Mokilese:

(13) Mokilese (Blevins 1996; McCarthy & Prince 1986)

<u>BASE</u>	<u>Progressive</u>	<u>Gloss</u>
(a) <i>Consonant initial</i>		
pɔdɔk	<u>pɔd</u> -pɔdɔk	plant
pilɔd	<u>pil</u> -pilɔd	pick breadfruit
sɔɔɔk	<u>sɔɔ</u> -sɔɔɔk	tear
pɑ	<u>pɑɑ</u> -pɑ	weave
wi.a	<u>wii</u> -wi.a	do
(b) <i>Vowel initial</i>		
alu	<u>al.l</u> -alu	walk
andip	<u>an.d</u> -andip	spit
onop	<u>on.n</u> -onop	prepare

As shown in (14) it is crucial to Blevins's analysis for REDs which are bimoraic, but misaligned with a syllable, to partially satisfy RED= $\sigma_{\mu\mu}$.

(14) Mokilese reduplication (adapted Blevins 1996, p. 526, Tableau 1)

/RED+andip/	Anchor	Contiguity	Onset	RED= $\sigma_{\mu\mu}$	MAX B-R	DEP I-O
a. $\sqrt{\underline{an.d}}=an.dip$			*	+	**	
b. $\underline{an.z}=an.dip$			*	+	**!*	*
c. $\underline{a.z.n}=an.dip$		*!	*	+	***	*
d. $\underline{an}=an.dip$			*!*		***	
e. $\underline{a.n}=an.dip$			*	*!	***	
f. $\underline{an.di.p}=an.dip$			*	*!		
g. $z\underline{an.d}=an.dip$	*!			+	**	*

As shown in this tableau, Blevins introduces a new diacritic, the '+' sign, to indicate partial satisfaction of the 'templatic' constraint. The interpretation of the '+' is explained in a footnote (p.528, fn 5):

"Violations of $[RED]=\sigma_{\mu\mu}$ are of two sorts: those that satisfy the constraint but have more material (marked with + for each additional segment, * for each additional syllable), and those that do not satisfy the constraint in having too little material [also marked with *]."

In other words, the '+' diacritic indicates candidates which satisfy the weight condition defined by $RED=\sigma_{\mu\mu}$, but which violate the alignment condition. This new diacritic encodes Blevins's claim that candidates which satisfy weight still minimally satisfy the heavy syllable template. Only candidates which violate alignment and weight completely violate the template, earning a '*'. Notice, it is crucial in this analysis to distinguish minimal and maximal violation of the template. Otherwise the actual surface candidate (14a) would violate the same number of constraints as other misaligned candidates which are underweight or overweight and so not be chosen as optimal.

Adopting Blevins's interpretation of templatic constraints like $RED=\sigma_{\mu\mu}$ or $RED=Ft$ would also solve the KiNande problem illustrated in tableau (10). The overcopy candidate (10e) would be given a '+' mark for the $RED=Ft$, since it is misaligned but satisfies the weight condition on the foot. The underweight misaligned candidate in (10f) would be given a '*', and so be non-optimal. Although this analysis would work, it is not entirely satisfactory. First, it is undesirable to introduce a new type of constraint satisfaction, namely the contrast between minimal and maximal satisfaction encoded in the '+' vs. '**' distinction. Further, even if we use two different diacritics to distinguish violations of the weight vs alignment conditions defined by the templatic

constraint, conflating the conditions makes it impossible to make explicit which other constraints motivate violations of the alignment condition. If those constraints are ranked above RED=Ft, that implies incorrectly that both alignment and weight could be violated to satisfy those higher ranked constraints. There is no way to show explicitly that the weight condition decides the winning candidate when alignment cannot be satisfied due to higher ranked alignment related constraints.

4. Splitting Weight and Alignment

4.1 Misalignment to satisfy weight

These problems can be solved by splitting templatic constraints like RED=Ft into two constraint families, one evaluating the alignment of the RED string with the constituent defining the shape of RED, the other evaluating the mapping between weight-bearing segments in the RED string and the required weight units (syllables or moras) of that constituent. I follow Crowhurst & Hewitt (1998) in proposing that alignment constraint conjunctions like the one in (15a) best define the requirement that a RED string be coextensive with some prosodic constituent (PCat) like a heavy syllable or a foot.⁶ I propose that we can adapt correspondence constraints (McCarthy & Prince 1995) to evaluate the weight of the RED string.⁷ MAX RED- PCat (15b) defines RED maximality: it is violated if the RED string contains more segments than can be mapped into the weight units of the relevant PCat. DEP RED-PCat (15c) defines RED minimality: it is violated if the RED string contains fewer segments than are required to fill the weight units of the relevant PCat.

(15)

(a) Alignment condition: $\text{AlignL}(\text{RED}, \text{PCat}) \cap \text{AlignR}(\text{RED}, \text{PCat})$

For example, **RED=Ft**: $\text{AlignL}(\text{RED}, \text{Ft}) \cap \text{AlignR}(\text{RED}, \text{Ft})$

Weight conditions:

(b) **MAX (RED, PCat)**: Every weight unit of the RED string (syllable nucleus if PCat is not quantity sensitive, mora if it is) is parsed into a weight-bearing position (syllable nucleus/mora) of the RED PCat.

For example, **MAX RED-Ft**: Every nuclear element of the RED string is parsed in a syllable nucleus of the RED Ft.

(c) **DEP (RED, PCat)**: Every weight unit (syllable nucleus if PCat is not quantity sensitive, mora if it is) of the RED PCat is associated with an element of the RED string.

For example, **DEP RED-Ft**: Every nucleus of the RED Ft is associated with an element of the RED string.

Splitting the alignment and weight conditions into two constraint families allows us to state explicitly the constraint rankings that optimize overcopy in KiNande with KiNande vowel-initial REDs (1d). The vowel-initial REDs are necessarily misaligned with a foot, because prosodic well-formedness constraints

outrank RED alignment. (I am assuming feet must be aligned with syllables.) Overcopy is the optimal way to satisfy the weight conditions on the reduplicative foot, because DEP RED-Ft, the constraint requiring both syllables (nuclei) of the RED foot to be associated with elements of the RED string, outranks Integrity (6a). The tableau in (16) exemplifies the analysis:⁸

(16)

	DEP I-O	Ft Bin	MAX RED- Ft	DEP RED- Ft	*VV	Integ	On- set	Align RED- Ft
(a) √ e(ry= <u>e.se</u>).s+[e.sa						*		**
(b) * e(ry= <u>e.s</u> +[e).sa				*!				**
(c) * eri=(<u>e.sa</u>).+[e.sa							*!*	
(d) * e(ry= <u>esa</u>)+[y esa	*!							*
(e) * e(ry= <u>ese</u> +[e)sa					*!			**
(f) * ery= <u>e.(se.s</u> +[e).sa			*!	*		*		**
(g) √ eri=(<u>swa.swa</u>)+[swa						*		
(h) * eri=(<u>swa</u>)+[swa		*!						

Candidate (16a) is optimal for VCV bases, because it satisfies the weight conditions on RED even though it is misaligned. Candidates (16b, f), while equally misaligned, are non optimal because the second syllable of the RED-Ft is not filled by an element of the RED string. Better aligned candidates (16c,d) are non optimal because they violate higher ranked prosodic constraints. Candidate (16e) is interesting because it represents the optimal output in Kikuyu. Notice the same constraint ranking, *VV >> Integrity, which makes overcopy, not vowel lengthening, the optimal way to satisfy minimality for monosyllabic bases like (16g) crucially also optimizes overcopy to satisfy the minimal weight constraint for VCV bases.

The tableau in (17) shows that simply reversing the ranking of *VV and Integrity makes overcopy the non optimal way to satisfy weight conditions on the REDs of both CV and VCV bases in Kikuyu:

(17)

	DEP I-O	Ft Bin	MAX RED-Ft	DEP RED- Ft	Integ	*VV	On- set	Align RED- Ft
(a) $\sqrt{(ko=i.na+i).naina}$						*		**
(b) * (ko= <u>i.nai</u>).na+i.naina			*!		*			**
(c) * ko.=(<u>i.na</u>).+[i.naina							*!*	
(d) * (ko= <u>i.na</u>)+[yinaina	*!							*
(e) * (ko= <u>i.n</u> +i).naina				*!				**
(f) $\sqrt{ko=(\underline{goo.a})+goo.a}$						*	*	
(g) * ko=(<u>goa.goa</u>)+goa					*!			
(h) * ko=(<u>goa</u>)+goa		*!						

Candidate (17a) is optimal because the first half of the diphthong is associated with the second syllable of RED-Ft, satisfying DEP RED-Ft. Even though this candidate is misaligned with RED-Ft, better aligned candidates violate higher ranked prosodic constraints. Notice that the same constraint ranking that optimizes lengthening to satisfy minimality for monosyllabic bases (17f) crucially also optimizes a bimoraic syllable at the RED-Base juncture to satisfy the minimal weight requirement on RED for vowel-initial bases.

To sum up this section, once weight and alignment are made separate conditions on the prosodic well-formedness of the reduplicative string, the original puzzles posed by KiNande overcopy have a straightforward solution. Overcopy is required for VCV bases even though they are disyllabic because obligatory hiatus resolution (with no long vowels) at the RED-Base juncture means that one copy of the base will necessarily only provide one syllable for the RED-Ft (see (16b), above). There is no overcopy in Kikuyu because it has bimoraic syllables. This allows a single copy of a VCV base to be associated with both syllables of the RED-Ft, as shown in (17a), even though there is obligatory hiatus resolution at the RED-Base juncture.

4.2 Gaining weight through misalignment

A further advantage of splitting weight and alignment is that it provides an explicit account of reduplication patterns where weight conditions are violated in

order to improve reduplicative alignment. The continuous reduplicative prefix of Arrernte/Aranda, a N. Paman language of Australia, illustrates this sort of overweight overcopy. As Berry (1996) shows, the RED is a prefix, occurring in word-initial position. If the base verb is consonant-initial, the shape of this RED is a single light syllable, as illustrated by the data in (18a). If the base verb is vowel-initial, however, the RED is two syllables long, as shown in (18b):

(18) Arrernte/Aranda (Berry 1996, (46, 47), pp 225, 226)⁹

(a) *Consonant-initial*

kutye-me	<u>ke</u> -lpe-kutye-me	'is gathering'
tnye-me	<u>tnye</u> -lpe-tnye-me	'falling/staggering'
mpware-me	<u>mpwe</u> -lpe-mpware-me	'making'
therre-	<u>the</u> -lpe-therre	'to laugh/smiling'

(b) *Vowel-initial*

itirre-me	<u>ite</u> -lp-itirre-me	'is thinking'
atake-	<u>ate</u> -lp-atake-me	'continuously smashing'
atwe-me	<u>atwe</u> -lp-atwe-me	'hitting'
ilwe-	<u>ilwe</u> -lp-ilwe	'die/continually'

Berry (1996) proposes that the overcopy found with vowel-initial bases is motivated by the ill-formedness of onsetless syllables. Copying an additional CV syllable allows the RED to contain an optimal syllable. This generalization is formalized in (19):

(19) RED=σ: The reduplicant consists of a single well-formed [onsetful] syllable. (Berry 1996, p. 229, (51))

This proposal correctly links the ill-formedness of the vowel-initial REDs with the ill-formedness of onsetless syllables. However, it misses the generalization that word-initial vowels are excluded from the syllable count for other prosodic processes in Arrernte/Aranda, not just reduplication. As work like Davis 1985, 1988, Downing 1998b, and Goedemans 1998 shows, word-initial vowels in Arrernte/Aranda resist being stressed. In (20a), we see that main stress is regularly assigned to the initial syllable if it begins with a consonant. But onsetless initial syllables are not stressed, as shown in (20b):

(20) Arrernte/Aranda stress patterns (Strehlow 1942-44)

(a) *Consonant-initial words of three or more syllables*

rá:tama	'to emerge'
kútungùla	'ceremonial assistant'
wóratàra	place name

(b) *Vowel-initial words of three or more syllables*

ergúma	'to seize'
ulúrba	'cold; cold wind'
urká:buma	'to work'

As argued in Downing (1998b) and Goedemans (1998), word-initial vowels are excluded from the stress domain (PWord) because PWord must begin with an

onsetful syllable. (This is optimized by the constraint labeled **Extrapros** in (22). See Downing (1998b) for discussion of how best to formalize this constraint.) It is not an accident, then, that word-initial vowels of the RED string are also excluded from the prosodic parse of the RED- σ : word-initial vowels are in general extraprosodic. Overcopy can be accounted for by proposing that the RED- σ is left-aligned with the PWord:

(21) **AlignRED**: AlignL(RED- σ , PWord): Align the left edge of the RED- σ with the left edge of PWord.

As shown in tableau (22), if this constraint outranks both Align RED- σ and MAX RED- σ (15b) overcopy is the optimal means of reduplicating vowel initial bases. (' is PWord edge; the RED- σ is in parentheses):

(22)

RED-lp-ireput	An-chor	DEP I-O	Extra- ⁱ pros	Align RED	DEP RED- σ	MAX RED- σ	Align RED- σ
a. $\sqrt{}$ i[(re-l)p-ireput						*	**
b. * (i)[p-ireput				*!			*
c. *[(re-l)p-ireput	*!						*
d. * [(C _i -l)p-ireput		*!					**
e. * [(i-l)p-ireput			*!				*
f. * i[(re)pe-lp-ireput						**!	**

Candidate (22a) is optimal even though its RED is 'overweight' because competing candidates which satisfy the weight condition fail to align RED within PWord (22b) or begin PWord with an onsetless syllable (22e) or violate other constraints to allow PWord to begin with an onset (22c,d).

5. Conclusion

In sum, I have shown that there are two ways that Onset can motivate overcopy in reduplication and that in both cases overcopy is best accounted for by splitting templatic constraints on RED into two families: the alignment constraint family and the weight correspondence constraint family. This allows us to show explicitly how weight conditions interact with alignment conditions on RED to optimize overcopy. In Arrernte/Aranda, word-initial vowels are in general extraprosodic to satisfy a constraint requiring PWord to begin with an Onset. If word-initial REDs are to be included in PWord, a vowel-initial base

must overcopy to avoid being entirely extraprosodic. In KiNande, Onset penalizes vowel hiatus and syllables are monomoraic. As a result, a single copy of a VCV base cannot be parsed into two syllables distinct from the base. To satisfy weight requirements on RED, the same overcopy strategy is resorted to for VCV bases as for monosyllabic bases. This analysis predicts, in fact, that any language that has a strategy for expanding the REDs of monosyllabic bases to satisfy weight requirements on RED will also have a strategy for expanding VCV bases and that these strategies will be related. It is a topic for further research to test this hypothesis on more languages.

Notes

¹ This research was supported by NSF POWRE grant #SBR-9806180. Thanks to Larry Hyman, Sharon Inkelas, David Odden, Pat Shaw and Su Urbanczyk for thoughtful comments and criticism on the content and presentation of this paper. The usual disclaimers apply.

² The Kikuyu data in this paper comes from Benson (1964) as well as my own work with Muroki Mwaura, a native speaker of Kikuyu from Nairobi, Kenya. Many thanks to Muroki for his patience and cooperation in helping me learn about his language.

³ As argued in Downing (in press; to appear a, b), the best explanation for the fixed vowel /-a/ in the KiNande and Kikuyu RED is that RED must satisfy a morphological constraint and ‘sound like’ a canonical verb stem by ending in the unmarked Inflectional Final Suffix, /-a/. The REDs in (1d, 2c) do not end in /a/ to avoid vowel hiatus. For reasons of space, only the prosodic conditions on the shape of RED are discussed here.

⁴ In all tableaux, the RED string is underlined; the RED-Foot is indicated by parentheses.

⁵ This formulation of the Onset constraint is as an anti-alignment constraint, penalizing syllables which are left aligned with a strong (nuclear) mora. I am following work like McCarthy & Prince (1986) in assuming a representation in which onset segments are linked directly to the syllable rather than to the nuclear mora.

⁶ Constraint conjunctions are evaluated on analogy with logical conjunction. The conjunction is satisfied iff both constraints making up the conjunction are satisfied. If either of the constraints or both are violated, the conjunction is violated. See Crowhurst & Hewitt (1998) and Downing (1998) for further discussion of constraint conjunction.

⁷ Typically correspondence constraints compare two strings, rather than a string with the prosodic constituent which parses it. However, Ito & Mester's (in press) have shown that alignment must be modified to evaluate the trace between a prosodic constituent and a string. The proposal defended here extends their "realignment" theory to correspondence. MAX (RED-PCat) is the correspondence equivalent of their 'is a' constraint; evaluating an upwards trace from a string to a prosodic constituent. DEP (RED-PCat) is the equivalent of 'is the content of', evaluating a trace down from the prosodic constituent to the string. See Downing (1998a) for more detailed discussion.

⁸ Constraints optimizing infixing in the longer V-initial stems have been omitted from this tableau due to space considerations. Compare this tableau with (10) to confirm the PStem parses indicated here with '['.

It is worth noting that the parse in (16f) is the one given to the reduplicants of VCV bases by Mutaka & Hyman (1990) and Mutaka (1994). As we can see, this parse violates weight conditions on RED and RED-Ft overlaps PStem. This makes it prosodically a much worse parse than (16a) and so not the optimal output.

⁹ The Arrernte/Aranda data is cited in the orthography. It should be noted that the only complex onsets permitted in this language are consonant-glide sequences; the only coda consonants permitted are coronal sonorants and nasals homorganic with a following consonant. All other apparent consonant sequences are orthographic representations of single segments. The reader is referred to Berry (1996) for further discussion.

References

- Applegate, Richard B. 1976. "Reduplication in Chumash." In Margaret Langdon & Shirley Silver, eds. *Hokan Studies*. The Hague: Mouton, 271-283.
- Benson, T.G. 1964. *Kikuyu-English dictionary*. Oxford: Oxford University Press.
- Berry, Lynn. 1996. Alignment and adjacency in Optimality Theory: Evidence from Warlpiri and Arrernte. Ph.D. dissertation, University of Sydney.
- Blevins, Juliette. 1996. "Mokilese reduplication." *LJ27*: 523-530.
- Crowhurst, Megan & Mark Hewitt. 1998. Conjunctive co-ordination. ms., University of North Carolina at Chapel Hill & Brandeis University.
- Davis, Stuart. 1985. "Syllable weight in some Australian languages". *BLS 11*: 398-407.
- Davis, Stuart. 1988. "Syllable onsets as a factor in stress rules". *Phonology 5*: 1-19.
- Downing, Laura J. 1998a. "Morphological and prosodic constraints on Kinande verbal reduplication." ms., UC-Berkeley.
- Downing, Laura J. 1998b. "On the prosodic misalignment of onsetless syllables". *NLLT 16*: 1-52.

- Downing, Laura J. in press. "Verbal reduplication in three Bantu languages". In Harry van der Hulst, René Kager and Wim Zonneveld, eds. *The prosody-morphology interface*. Cambridge: Cambridge University Press.
- Downing, Laura J. to appear, a "Morphological correspondence in KiNande reduplication." *BLS* 23.
- Downing, Laura J. to appear, b. "Prosodic Stem ≠ Prosodic Word in Bantu". In T. Alan Hall & Ursula Kleinhenz (eds.), *Studies on the Phonological Word*. Amsterdam: Benjamins. (Current Studies in Linguistic Theory)
- Goedemans, Rob. 1998. *Weightless segments: a phonetic and phonological study concerning the metrical irrelevance of syllable onsets*. The Hague: HAG.
- Inkelas, Sharon. 1989. Prosodic constituency in the lexicon. Ph.d. dissertation, Stanford.
- Inkelas, Sharon. 1993. "Deriving cyclicity". In Sharon Hargus & Ellen M. Kaisse, eds. *Studies in Lexical Phonology. Phonetics and Phonology* 4. San Diego: Academic Press, 75-110.
- Itô, Junko & Armin Mester. in press. "Realignment". In Harry van der Hulst, René Kager and Wim Zonneveld, eds. *The prosody-morphology interface*. Cambridge: Cambridge University Press.
- McCarthy, John & Alan Prince. 1986. Prosodic morphology. ms. University of Massachusetts, Amherst & Brandeis University.
- McCarthy, John & Alan Prince. 1993. "Generalized alignment". In Geert Booij & Jaap van Marle, eds., *Yearbook of Morphology* 1993, 79-153.
- McCarthy, John & Alan Prince. 1994. "The emergence of the unmarked: optimality in prosodic morphology." *NELS* 24: 333-379.
- McCarthy, John & Alan Prince. 1995. "Faithfulness and reduplicative identity". *Papers in Optimality Theory, UMOP* 18: 249-384.
- Mutaka, Ngessimo M. 1994. *The lexical tonology of Kinande*. Munich: LINCOM EUROPA.
- Mutaka, Ngessimo & Larry Hyman. 1990. "Syllables and morpheme integrity in Kinande reduplication." *Phonology* 7: 73-119.
- Peng, Long (Bruce). 1991. Swati and Kikuyu reduplication: evidence against exhaustive copy. *SAL* 22: 45-72.
- Rose, Sharon. to appear. "Multiple correspondence in reduplication". *BLS* 23.
- Rosenthal, Sam. 1994. Vowel/glide alternation in a theory of constraint interaction. Ph.D. dissertation, University of Massachusetts-Amherst.
- Strehlow, Theodore G. H. 1942-44. "Aranda phonetics". *Oceania* 12, 255-302.

Root Infinitives and Full CP Structures: Types of Dutch Wh-root infinitives

Eric Drewry

Tunghai University, Taichung, Taiwan, and the University of Delaware

1. Introduction

Data from Diederik, one triplet in the Dutch child language in the Schaerlaekens corpus (Schaerlaekens and Gillis 1987 #4963) of the CHILDES database (McWhinney and Snow, 1997) includes a significantly high percentage (nine out of thirty-six, or 25%) of Wh-questions with an non-finite form of the verb in the matrix clause ("root infinitives"). This phenomenon is incompatible with predictions made under the "truncated structure" theory (Rizzi 1994b, Haegemann 1996). Haegemann claims that the truncation of the CP-node from the syntactic structure of young Dutch children in the CHILDES corpus is well supported by the *de minimus* occurrence of Wh-questions with root infinitives (1996). In contrast to previously published data, Diederik's significant spontaneous production of such questions requires a closer examination. This paper investigates two of the utterances published under the rubric child Wh-root infinitives, as well as all of Diederik's Wh-root infinitives and concludes that there are several different types of root infinitives, some counterfeit, rather than the uniformity assumed in research to date. Analyzing the context of the utterance allows significant distinctions to be made. Under this re-examination none of the data are seen as significant counter-examples to the truncation theory of Rizzi and Haegemann.

1.1. Clausal truncation

Part of what is so striking about the incidence of root infinitives in child V2 languages is that there is a very pronounced patterning of nonfinite verb forms with clause-final position, and inflected verb forms with clause-second position (Clahsen and Penke 1992, Poepl and Wexsler 1993, Guasti 1994, *inter alia*). In order to account for the variation in verb placement, and alternations in finite and non-finite verb forms in developing child syntax Rizzi has proposed the theory of clausal truncation (1994b), which allows children to alternate between the full

adult CP structures, which children show early evidence of, and a structure which has been truncated of its upper phrasal nodes. This truncation typically occurs below the Temporal node, so that the verbs are found in infinitive form. The term for such infinitives in matrix, or root, clauses, is "root infinitives" (Rizzi 1994b). For child Dutch, Haegemann has suggested that the truncated child structure has the following nodes still available to the child, after the structure in (3) above has had the upper clausal nodes truncated (1996).

(1) AGR(O)P > NEGP > (PREDP) > VP with overt subjects adjoined (NOM)

1.2. V-2 language adult structures

Dutch, as a Germanic language, exhibits V2 characteristics in the adult grammar as shown by the typical sentences below in which the verb in matrix declaratives is in second place, while in embedded clauses the verb occupies clause-final position:

(2) Hij kocht gisteren een krant
 He bought yesterday a newspaper
 Yesterday he bought a paper.

(3) ...dat hij gisteren een krant kocht
 ...that he yesterday a newspaper bought
 ...that he bought a paper yesterday.

In the generative tradition, the order of the phrasal nodes, in descending order, has been determined to be as follows¹:

(4) CP > FP > {AGR(S)P}² > TP > AGR(O)P > NEGP > (PREDP) > VP
 (Haegeman 1996)

In order for the verb to occupy second position in matrix declaratives, it moves to the C^o position. In embedded clauses, the verb simply does not move, as the VP is right-headed.

1.3. V-2 language child production

The above description of adult V2 phenomena contrasts with typical early child production. Here we introduce data from the triplet Diederik, who will be one of the focal points of the discussion to follow (Schaerlaekens and Gillis 1987 #4963). In sentence (5) Diederik is moving the inflected verb along with its separable particle, which should be left in clause-final position as indicated by the English translation, into second position. This is movement with less restraint than is allowed in adult Dutch, which

requires that the particle remain in its original clause-final position. The adult order is reflected in the English translation. In (6), which is from the same file when Diederick was 2;4:14, Diederick has left the infinitive verb in clause-final position. Clearly, at this stage, he is working out the possibilities of verb movement. In (5) and (6) he is exhibiting the phenomenon that has attracted so much attention: inflected verbs are moved to V2 position, while non-finite verb forms remain in clause final position. These latter are called root infinitives (Rizzi 1994b).

(5) Die(derik) op(r)aap zwijntje. (DIEDE06.CHA, line 119)
 Diederik up-pick(1S) piggie
 Diederik is picking the piggie up

(6) Paa(r)d ook in (s)taan. (DIEDE06.CHA, line 154)
 Ho(r)se also in stand (inf.)
 The horse [is] standing in (there) too.

1.4. The ratio of finite to root infinitive clauses

As children acquire the movement rules of the adult grammar the occurrence of child anomalies, such as root infinitives, decreases gradually. This decrease has been shown in a statistical way for three of the largest CHILDES files for Dutch: Hein, Thomas, and Niek (Haegemann 1996). One can use the child's age to predict approximately what percentage of root infinitives might be produced. It has been noted, however, that when the matrix clause begins with a Wh-question word, there is almost never a root infinitive. This is consistent with the truncation theory, which asserts that there is no CP-node for the Wh-term in a root infinitive, so such a question should always have an inflected verb form. Another similar phenomenon, the non-subject-initial root infinitives have been consistently considered performance errors (Haegeman 1996, Poeppel and Wexler 1993, Boser et al. 1992).

The spontaneous production of Thomas in the Utrecht corpus conforms perfectly to this prediction: Thomas produced 253 Wh-questions without a single Wh-root infinitive (Haegemann 1996).

The Hein utterances, from the same corpus, only produced two exceptions, which require a *de minimus* criterion for judging the occurrence of Wh-root infinitives in child production. Between the ages of 2;4 when Hein produced 23% root infinitives and the age of 3;1 when Hein produced 6% root infinitives, Hein produced 721 root infinitives out of 4,489 clausal utterances (Haegemann 1996), for an overall average of 16% root infinitives. These utterances included 90 Wh-questions. If, so the logic goes, the child's root infinitives were not paired with clausal truncation, one would expect 16%, or 15, of the Wh-questions to be root infinitives. If, on the other hand, a CP node is incompatible with a root

infinitive, then one would expect none of the Wh-questions to be root infinitives. Hein produced 2 child Wh-root infinitives, which is deemed clear support for the truncation theory under the *de minimus* criterion.

1.5. Reclassifying both exceptions

While there are certainly instances of spontaneous Wh-root infinitives in child data, it is instructive to look more closely at those produced by Hein. They will disclose the possibility of subcategorizing Wh-root infinitives into several types. The exceptions, as noted by Haegeman follow (1996):

- (7) Hoe heten? (Hein 2;06)
How call
- (8) Waarom <niet> [/] nu & ni [/] niet wassen
Why <not> now not wash

When seen in a larger context, each of these exceptions proves to be standard Dutch. In this view, the Hein corpus can also be said to perfectly reflect the predictions made by the truncation theory (Rizzi 1994b, Haegeman 1996). In order to understand the reinterpretation of the first exception one must notice that *Hoe heten?* has a missing noun phrase, which could be interpreted one of two ways: "Hoe X heten" in which case it is a Wh-root infinitive as noted by Haegeman, or "Hoe heten X+Y+Z" in which case the verb is a normal plural adult inflected form.

To include sufficient information to interpret each of Haegeman's exception, a more complete entry from the CHILDES database is reproduced below, with glosses added:

- (9) a. Hein:Hoe heten? (H800922.CHA line 830)
How call (infinitive OR plural verb)
<Child is referring to picture book p. 19>
- b. Mother: dat zijn alle kinderen van haar
that are all children of her
Those are all children of hers.
- c. Hein:die krijgen niets
they get nothing
They don't get anything.

As seen by the subsequent conversation, the subject of the verb refers to a picture and at the moment they are discussing a number of children who get don't get anything. The first exception noted in the Hein corpus is, therefore, not a Wh-root infinitive at all, but an inflected plural verb. With this example as background, we can generally say that two-word

phrases are all potentially ambiguous and need to be seen in a multi-utterance context in order to be interpreted.

A closer look at the context of the second exception also reveals that it is not an exception at all, but rather an adult form of a similar sort.

(10) Context of Hein's WH-RI

- a. Mother: Je hoeft nu niet in bad
You need now not in bath
You don't need (to go into the) bath now.
- b. Hein: He - ?
Huh?
- c. Mother: Morgenavond weer
Tomorrow evening again
Not until tomorrow evening.
- d. Hein: Waarom <niet> [//] nu & ni [/] niet wassen
[restated without performance errors]:
Waarom nu niet wassen
Why not wash now?

A short explanation of Wh-root infinitives in the adult grammar will show that it is only Hein's performance errors which make the utterance seem distinguishable from an acceptable adult form.

1.5.1 Allowable Adult elliptical(CP)root infinitive

The example in (11) below shows that in adult Dutch (and English as seen in the translation), Wh-root infinitives are acceptable in certain discourse contexts. A typical example of Dutch adult speech is a structural mirror of Hein's utterance in (6) above as restated without performance errors (Haegeman 1996 (her #14)):

- (11) Waarom niet eerst naar huis gaan?
Why not first to home go
Why not first go home?

Thus Hein's second instance of a Wh-root infinitive is seen to indeed be Wh-root infinitive, but one that is an acceptable adult form with performance errors³. Neither exception deserves to be counted as a reason to discount the truncation theory of developing child syntax. One is an inflected verb, and the other is an adult Wh-root infinitive.

2. Diederik's production of Wh-root infinitives

Diederik produced a total of 1708 utterances, of which 88 were questions⁴. Of the questions, 41 were Wh-questions. As mentioned in the

introduction, ten of these Wh-questions were root infinitives, or an abnormally high 25% Wh-root infinitives. Interestingly, all of the root infinitives were in files 9 and 10, recorded when Diederik was 2;8.1 to 2;8.28. This was a remarkable phase of Diederik's learning, since he uttered his first Wh-questions during the previous recording session (file 8) at 2;6.22 and had acquired to proper verb movement without resumptive XPs and without deleting necessary XPs by the age of 2;10.28 (file 11). As a base line for comparison of the frequency of root infinitive usage during this transition period, in file 8, when Diederik was 2;6.22, he produced 71 declaratives, of which 40 were scorable root infinitives (i.e., more than two words long, among other criteria⁵), leading to a norm of 56% root infinitives. The 25% occurrence of Wh-root infinitives in the following two recording sessions certainly can not be considered *de minimus* and therefore requires further explanation. It may be noted in passing that Diederik's 56% root infinitives at age 2;8 is exceptionally high percentage for a child of that age, as is seen in a comparison with other Dutch data: Hein 16% (2;4-3;1), Fedra 26% (1;10-2;1), Tobias 36% (1;10-1;11), Laura 36% (1;8-2;1) (Hoekstra and Hyams 1998).

2.1. The first several Wh-root infinitives in the context of other question forms

As noted in the discussion of (8) above, at this stage Diederik was using a number of non-adult movement strategies. A larger number of movement possibilities in children's developing grammar was also noted in the results of experiments done by Thornton and Crain (1994). Diederik's Wh-root infinitive phase begins in a frame of other question forms which make the root-infinitive look rather like a matrix VP-deletion strategy (12a-d). In the following sequential questions from file 9, Diederik's first question uses a resumptive root infinitive (marked "Resumptive RI") instead of a trace for the moved (and inflected) matrix verb (12a). A matter of seconds⁶ later he dropped the resumptive verb to produce a perfectly adult-like Wh-question (12b), except that he had also dropped the determiner from the NP (marked "Adult-like"). Another several seconds later Diederik again produced a Wh-question with a resumptive root infinitive (12c). Approximately the same amount of time later, he produced the first of his ten Wh-root infinitives (12d). A little while later, Diederik again had an inflected verb following his Wh-word, and the sentence-final VP served as a resumptive root infinitive (12e). An equally short time later, Diederik seems again to have dropped the inflected verb and retained the sentence final VP, which remains as a root infinitive (12f).

- (12) a. DIEDE09.CHA,line424:*DIE:Moeke wa(ar) (i)s de olifant zijn?
 Resumptive RI Mommy where is the elephant be

- b. DIEDE09.CHA, line 430: *DIE: wa(ar) is eendje Moeke ?
Adult-like where is ducky Mommy
- c. DIEDE09.CHA, line 435: *DIE: waar is de olifant zijn?
Resumptive RI where is the elephant be
- d. DIEDE09.CHA, line 440: *DIE: waar de olifant zijn Moeke ?
RI where the elephant be Mommy
- e. DIEDE09.CHA, line 445: *DIE: Moeke waar is de olifant zijn ?
Resumptive RI Mommy where is the elephant be
- f. DIEDE09.CHA, line 461: *DIE: Moeke waar de een(d)eke zijn ?
RI Mommy where the du(ck)y be
- g. DIEDE09.CHA, line 466: *DIE: wa(ar) zijn ?
not scorable whe(re) are/be

This appearance of an alternation between fairly adult-like CP-structures (12a, b, c, and e), and structures requiring a CP node for the Wh-term but showing the verb in its phrase-final position (12d and f) are inconsistent with the truncation theory. Two further uses of whole-file contexts give us somewhat more insight.

2.2. A Comparative view of all ten of Diederik's Wh-RI's

Relying entirely on the context of the questions in 2.1. is not as informative in explaining the high percentage of Wh-root infinitives as a direct comparison of all 10 of them with one another. These are all of the Wh-root infinitives in Diederik's files.

- (13) a. waar de olifant zijn Moeke ? Where be the elephant, Mommy?
b. Moeke waar de een(d)eke zijn ? Mommy, where be the duckie?
c. wa(ar) eekhoo(rn)tje zijn? Where be the squirrel?
d. wa(ar) dit zijn? Where be this?
e. waar de konijneke zijn ? Where be the rabbit(ie)?
f. waar water zijn? Where be water?
g. waar de emmer zijn? Where be the pail?
h. waar de paddestoel zijn Where be the mushroom?
i. wa(ar) dat zijn? Where be that?
j. wa(ar) kinneke [:kindje] zijn? Where be kiddie?

One immediately notices two common characteristics of the data in 13: there is no variety in the choice of either the Wh-term or of the verb. Looking further at the next file (number 11) reveals that it was not until three weeks later at 2:9.19 that Diederik began asking his first "what" questions. The entire set of Wh-root infinitives is seen to occur during a time when Diederik has command of only a single Wh-term, and is not able to use that one except in the frame "Where + NP + be". It is arguable that the use of the verb be here disqualifies the utterances from being true

root infinitives, which have been asserted to be "restricted to event-denoting predicates" (Hoekstra and Hyams 1998 at 9). This, on the other hand, that is not an explanation, but rather a statistical observation that has been shown to hold cross-linguistically, with English-speaking children exhibiting apparently exceptional behavior. This data seems insufficient to draw firm conclusions, but perhaps Diederik is an exception not only in terms of percentage of Wh-root infinitives, but also in the semantics of his verb choice.

2.3. Does Diederik know "Adverb_i VP NP e_i" – focusing of adverbs ?

One can ask whether Diederik has, at the age in question, mastered the focus movement by which adverbs are preposed to clause-initial position. Especially in the case of locative adjuncts, both the movement rules and the semantics are very similar to that necessary for the syntax of the locative Wh-term *waar*. If Diederik shows a full CP structure for focused adverbs of location, it would seem logical that he would be able to use the same structure with Wh-terms of similar semantics. This would argue in favor of Diederik's Wh-root infinitives as belonging to a full CP structure and thus presenting data inconsistent with Rizzi's clausal truncation theory. In file 9 (2:8.1), which also records Diederik's first Wh-root infinitives, there are several examples of focused and non-focused locative adverbs (bolded). These are all such examples in the entire file:

- (14) a. datte **hier** zijn. (09,314) RI
That-a here be.
- b. de hond **hier** zijn. (09,409) RI
The dog here be.
- c. **daar** hangt nog papie(r)ke aan. (09,541) adult-like
there hangs still paper on (it)
There's paper still hanging onto it.
- d. dat **hier** zijn. (09, 799) RI
That be here.
- e. **hie(r)** A(r)no(I)d dat kan ook wel staan. (09, 809)
here Arnold that can also stand adult-like
Arnold can also stand that here.

In spite of the paucity of data, the pattern of these five utterances is fairly clear - where the adverb of place is preposed (14c and e), the verb is inflected and has moved out of clause-final position to V2 position (14c) or an intermediate position (14e). In contrast, where the locative adverb is positioned after the subject, the verb is in clause-final position and is infinitive in form (14a, b and d). Diederik seems to have mastered the focus movement for locative adverbs. Where the adverbs are not focused, however, he used only root infinitives. Since the Wh-term is clause-initial,

the verb should also have become finite and moved up out of clause-final position (or been merged in its inflected form into the derivation at a higher position, depending on one's theoretical framework) where the locative Wh-term *waar* is used. But this expectation is manifestly not fulfilled, leading to root infinitives. Because of the paucity of data, one is left to choose between actual or pseudo-root infinitives. This writer opts for the latter position out of respect for the overwhelming data in other research which points away from Wh-root infinitives. At age 2;8, Diederik seems to manifest a phenomenon of boiler-plate use of "Where + NP + be", however unsatisfying that may be. This explanation, however, is reminiscent of Haegeman's suggestion that "overt subjects in root infinitives occupy an A-bar position, possibly and adjoined position" (1996 at 290). The most satisfying explanation at this time, then, is that the Wh-term in Diederik's ten Wh-root infinitives is similar to an overt subject, in that the Wh-root infinitives could occupy an adjoined A-bar position. There is insufficient data in the file to determine more precisely whether Diederik is using a boiler-plate approach ("Pseudo-Wh-infinitives") or whether some other explanation is more tenable.

3. Conclusion

Surface form evaluation of putative Wh-root infinitives should consider (at least) three possibilities: adult Wh-root infinitives, Wh-movement to a higher node (inflected verbs which are homophonous with infinitives), or Pseudo-Wh-root infinitives. A great majority of Dutch child forms of root infinitives conform to the prediction that there is no CP-node in these utterances. The proportionally insignificant number of Wh-RI questions in the Dutch data bases is clear evidence of this. Children as young as 2;8, however, may also be capable of producing adult-equivalent Wh-RI questions, as evidenced by Hein's second Wh-root infinitive (8). Other utterances which seem to be Wh-RI questions should be closely examined in their context to see if they are robust exceptions to the predictions made by the functional-node truncation theory of Rizzi and Haegeman. When Diederik's production of 25% Wh-RI questions is re-examined this way, it can be seen as exceptional in several ways: the entire production occurred during a very short time frame, the only Wh-term used in these Wh-RI questions is "where", and this production was during the period before he had learned any other Wh-question word. Additionally, the only verb form used in the Wh-RI's was the copula "to be". Inquiry into his acquisition of the movement of focused locative adverbs has shown that the child can demonstrate apparent mastery, or near mastery, of the movement rules of these terms without applying that system to the Wh-term *where*, at least when that is the only Wh-term in his repertoire. The shortness of this phase in Diederik's production, combined with the exceptionally high percentage of declarative root infinitives which he was

producing at a relatively late age make him a candidate for a child passing through a stage in syntactic development which other children may skip over or which may pass so quickly in other children that it is seldom noticed.

Notes

My thanks and gratitude to my teachers at the University of Delaware, Gabriella Hermon and Colin Phillips, and my colleague at Tunghai University Julian Linnell for their help in analyzing the data and preparing this paper. All errors are mine. Additional gratitude is due to the National Science Council of the Republic of China for funding to attend WECOL, and to Elly van Gelderen for re-creating a speaking slot for me.

1. FP = clitic projection: [Head, FP] hosts clitics; [Spec, FP] hosts weak pronouns;
2. This node is not included in Haegeman's hierarchy
3. Hein's utterance in (8) as restated without performance errors was confirmed by native speaker of Dutch to be an acceptable adult form. My gratitude to Ms. Esterella de Roo of the Holland Institute of Generative Linguistics for this assistance.
4. The method of extraction was by the *grep* function of BBLite Editor.
5. Two-word Wh-questions were not considered scorable. For two-word declaratives, an inflected verb counted as finite. A third-person subject followed by a V+en counted as a root infinitive; a non-subject + infinitive separable verb also counted as a root infinitive.
6. The distance in the file from the first question in line 424 to the second question in line 430 in the CHILDES file indicate that the elapsed time is very short. No exact number of seconds is indicated, nor is the potential difference of several magnitudes of great importance to the point being made.

References:

- Boser, K., B. Lust, L. Santelmann and J. Whitman. 1992. The syntax of CP and V2 in early child German. *NELS* 23: 51-65.
- Clahsen, H. and M. Penke. 1992. The acquisition of agreement morphology and its syntactic consequences. In: J. Meisel (ed.), *The Acquisition of Verb Placement. Functional categories and V2 phenomena in language acquisition*. Dordrecht: Kluwer.
- Donaldson, B.C. 1991. *Dutch Reference Grammar*. Leiden: Martinus Nijhoff.
- Fontein, A.M. and A. Pescher-ter Meer. 1993. *Nederlandse grammatica voor anderstaligen*. Utrecht: Nederlands centrum buitenlanders.
- Guasti, M. T. 1994. Verb Syntax in Italian Child Grammar: Finite and nonfinite verbs. *Language Acquisition* 3; 1:1-40.

- Haegemann, L. 1996. Root Infinitives, Clitics and Truncated Structures.
 In: H.Clasen (ed.) *Generative perspectives in language acquisition*.
- Hoekstra, T. and N. Hyams. 1998. Aspects of Root Infinitives. In press.
- MacWhinney, B. and C. Snow. 1994. The CHILDES data base.
- Poepfel, D. And K. Wexler (1993). The full competence hypothesis of clausal structure in Early German. *Language* 69, 1-33.
- Rizzi, L. 1994b. Some Notes on Linguistic Theory and Language Development: The case of root infinitives. *Language Acquisition*. 3.371-393.
- Thornton, R. and S. Crain. 1994. Successful Cyclic Movement. In: Hoekstra and Schwartz (eds.) *Language Studies in Generative Grammar*. Philadelphia: John Benjamins B. V.

*Eric B. Drewry, Lecturer
 Department of Foreign Languages and Literatures,
 Tunghai University, Taichung, Taiwan, R.O.C., and
 Ph.D.Candidate,
 Department of Linguistics,
 University of Delaware,
 Newark, Delaware 19711 USA
 eric@mail.thu.edu.tw*

Easy Clauses to Mistake as Relatives: The Syntax of English Postnominal Infinitives¹

Stanley Dubinsky

University of South Carolina

1. Introduction

This paper examines postnominal infinitive phrases in English, and argues that they have a structure in which the complement of the determiner is a functional projection, DegP (degree phrase), rather than NP. Evidence for this comes from their restricted distribution, and from limitations in their meaning. After looking at infinitives that follow bare nouns, I will examine the distribution of postnominal infinitives co-occurring with prenominal adjectives, and show how the former affects the distribution and interpretation of the latter. This discussion will lead to the recognition of four classes of adjectives, defined on the basis of their distribution in this regard.

2. Postnominal Infinitives on Their Own

The principle claim put forward here is that postnominal infinitives, when part of a DP and not a separate purpose clause, are licensed by the head of a DegP.² A motivation for this claim is that DPs containing postnominal infinitives strongly tend to refer to types (as opposed to tokens). Two sorts of evidence support this assertion, one involving postnominal infinitives in definite DPs, and another involving indefinite DPs.

Consider first the case of definites. If we compare (1) and (2), we find that the phrase *the car to drive* is more restricted in its distribution than is *the car I wanted to drive*.

- (1) a. The car to drive is a Porsche.
b. *The car to drive is a missing a spark plug.
- (2) a. The car I wanted to drive is a Porsche.
b. The car I wanted to drive is missing a spark plug.

The infelicity of (1b) results from a clash between the type-denoting subject *the car to drive* and the predicate *missing a spark plug*, which denotes a stage-level

property that is anomalous for describing types of cars.

The preferred pronunciation of the definite determiner in (1a) provides further insight into this paradigm. In (1a), but not in (2a) or (2b), *t-h-e* is likely to be pronounced [ðij] or at least be heavily stressed. This special use, referred to as EMPHATIC *THE* (see Christophersen 1939, Quirk et al. 1985, and Epstein 1994), correlates with reference to a type or kind, rather than to a specific entity or token of that kind. For this reason, (3a) is better than (3b) when *t-h-e* is pronounced [ðij].

- (3) a. The [ðij] coffee you ought to buy is Starbucks.
 b. ??The [ðij] coffee you thought to buy is in a leaking package.

Suppose now that emphatic *the* involves a covert DegP, and further that postnominal infinitives are licensed within such DegPs. These assumptions would yield the account given in (4), where DegP has the phonologically null head, MAX.

- (4) [_{DP} the [_{DegP} MAX [_{NP} [_{NP} car]₁] [_{CP} Op₁ [_{IP} PRO to drive t₁]]]]]

In (4), *car* is postmodified by the infinitive *to drive*, and the resulting phrase *car to drive* is a complement of MAX. Since MAX prefers type-denoting complements, the interpretation of the phrase is restricted, as in (1).³

Another source of evidence for the type-denoting restriction on postnominal infinitives are constructions that involve *de dicto-de re* ambiguity such as (5a), where Jason might or might not have a particular person in mind.

- (5) a. Jason is looking for a person who pilots ships.
 b. A person who pilots ships is what/who Jason is looking for.

In the *de dicto* reading, the object of *look for* is a type, while in the *de re* interpretation it denotes a token or individual of that type. The two different readings correlate fairly well with the alternation of relative pronouns in (5b), where *what* indicates a *de dicto* reading and *who* tends to favor a *de re* reading. When the postnominal relative clause in (5) is replaced with an infinitival phrase as in (6), the ambiguity disappears and only the *de dicto* reading is available.⁴

- (6) a. Jason is looking for a person to pilot the ship.
 b. A person to pilot the ship is what/*who Jason was looking for.

This is most clearly seen in (6b), where only the relative pronoun *what* is acceptable. From this, I would propose that the phrase *a person to pilot the ship* has the structure given in (7), where DegP has a null head with the meaning SUFFICIENT.

- (7) [DP a [DegP SUFF [NP [NP person]₁ [CP [IP PRO₁ to pilot the ship]]]]]

The tendency for NP to be type-denoting can once again be attributed to the presence of a DegP.

Finally, as shown in (8), postnominal infinitives only occur with a limited range of determiners, and as in (9), are found to have the distribution of predicate nominals rather than definite NPs.

- (8) a. The/a/*my/*this car to drive is a Porsche.
 b. The/a/my/this car that I like to drive is a Porsche.
- (9) a. The car that Sidney polished this morning is the [ðij] car to drive.
 b. *This morning, Sidney polished the car to drive.

The contrasts in (8) and (9) are explainable on the understanding that (i) postnominal infinitive constructions denote types, (ii) DegPs headed by MAX or SUFF impose type-denoting restrictions on their complements, (iii) possessive and deictic determiners normally select token-denoting complements, and (iv) predicate nominal positions are typically occupied by type-denoting DPs.

3. Postnominal Infinitives in the Company of Adjectives

Positing a DegP immediately below DP, as in (4) and (7), has the added advantage of providing an account of constructions such as (10) in which a prenominal adjective and a postnominal infinitive appear to “wrap” the noun.

- (10) the [easiest] car [to drive]

First noted in Wells 1947, the semantic dependency between the prenominal adjective and postnominal infinitive in (10) is uncontroversial, accounting for the relative unacceptability of *??the easiest car*, as well as for the fact that *the best car to drive into the ground* is not necessarily *the best car*. If semantic dependency is a reflection of syntactic constituency (at some level of structure), then (10) begs an account in which the adjective and the infinitive form a constituent somewhere in the derivation.⁵

The DegP posited in section 1 can help to explain the structure of these. The proposed analysis of (10) has *-est* as the head of the DegP, and is given as the d-structure in (11) and as (12) following movement.

- (11) [DP the [DegP -est [NP [NP car] [AP easy [CP [IP PRO to drive Op]]]]]]
- (12) [DP the [DegP easy₁-est [NP [NP car]₂ [AP t₁ [CP Op₂ [IP PRO to drive t₂]]]]]]

The AP projected by *easy* is analogous to a “tough”-construction, containing an

infinitival complement. Its head, *easy*, moves in order to adjoin to the affix *-est*. Contrary to appearances, the movement of *easy* in (11)/(12) is not due to the morphological needs of the superlative affix. If this were the case, we should expect to find (13a) to be ungrammatical rather than (13b), since the degree element *most* is not a bound affix.

- (13) a. the most difficult car to drive
b.*the most car difficult to drive

As it turns out though, DegP heads always attract their corresponding adjectives. This is especially clear for those DegPs that are above the determiner, such as *too*, *so*, and *how*, and is demonstrated in (14).⁶

- (14) a. *so/too/how* kind a man
b.**so/too/how* a kind man

That these degree elements attract adjectives is fairly incontrovertible when one examines their interaction with phrases such as *partial to hard liquor* which normally occur postnominally, as shown in (15a) and (15b).

- (15) a. a man partial to hard liquor
b.*a partial man to hard liquor
c. He is too partial a man to hard liquor
for me to want to take a road trip with him.

Example (15c) clearly shows that the degree element *too* can force *partial* to occur prenominal.

The claim that degree elements attract adjectives is further supported by the interaction of superlatives and canonical adjective orders. It is well-known that prenominal adjectives often observe a canonical order. (16) and (17) illustrate this, with (16a) and (17a) being more acceptable than (16b) and (17b).

- (16) a. the tall wiry stranger b.??the wiry tall stranger
(17) a. the large blue house b.??the blue large house

When one of the adjectives is a superlative, though, it always precedes its nonsuperlative partner. This is illustrated in (18) and (19).

- (18) a. the largest blue house b. the bluest large house
(19) a.*the large bluest house b.*the blue largest house

In (18b), *blue* and *large* are in the reverse of their normal order, on account of the

first being superlative. Both (19a) and (19b) are unacceptable because the superlative adjective follows the nonsuperlative in each case. This is as much the case in (19a), where the two adjectives appear in their canonical order as it is in (19b) where they do not.⁷

The analysis proposed in (11)/(12) for *easiest car to drive* can explain this phenomenon as well. Assuming that the superlative affix projects a DegP complement of the definite determiner, canonical order is overridden in (18b) because the adjective *blue*, which is introduced in its canonical order, moves to adjoin to this affix (as in (18b')).

(18b') [DP the [_{DegP} blue₁-est [_{NP} [_{AP} large] [_{NP} [_{AP} t₁] [_{NP} house]]]]]

Notice in (18b') that each adjective, *large* and *blue*, is adjoined to the NP. *Blue* moves out of this base position and adjoins to the superlative affix *-est*. Under this analysis, *large bluest house* is ill-formed because there is no position outside of the superlative DegP where the adjective *large* might be inserted.

4. Some nice predictions to consider

It is clear now that a DegP, by attracting adjectives, can affect the possible order of modifiers within a DP, and given the analysis proposed for (10), we would predict that any additional prenominal adjective in that example would have to occur between *easiest* and the noun *car*. This is indeed the case, as (20) shows.

- (20) a. the easiest imported car to drive
b.*the imported easiest car to drive

The explanation for the contrast in (20) is rather straightforward, as illustrated in (21).

- (21) a. the [_{DegP} easy₁-est [_{NP} [_{NP} imported car] [_{AP} t₁ to drive]]]
b.*the imported [_{DegP} easy₁-est [_{NP} [_{NP} car] [_{AP} t₁ to drive]]]

In (21a), *imported* is a prenominal modifier of the noun *car*, and the adjective *easy* moves from its postnominal position and adjoins to *-est*. In (21b), the adjective *imported* is inserted between the head of DP and its DegP complement, and is not in a position from which it can modify *car*.

Similar contrasts can be constructed using indefinite DPs, supporting the analysis proposed in (7), where DegP has the phonologically null head SUFF. Consider the data in (22).

- (22) a. an easy trashy novel to read
 b.*a trashy easy novel to read

Based on the structure proposed in (7), this contrast is predicted. Compare (22a') and (22b').

- (22') a. an [_{DegP} easy₁-SUFF [_{NP} [_{NP} trashy novel] [_{AP} t₁ to read]]]
 b. a trashy [_{DegP} easy₁-SUFF [_{NP} [_{NP} novel] [_{AP} t₁ to read]]]

In (22a'), *easy* moves to the head of the DegP, while the adjective *trashy* directly modifies the noun *novel*. In (22b'), *trashy* occupies a position between the determiner and its DegP complement and is ungrammatical for this reason.

Notice that the contrast in (22) disappears when *trashy* and *easy to read* are both prenominal modifiers.

- (23) a. a trashy easy to read novel
 b. an easy to read trashy novel

In (23), the order of modifiers is not fixed and we might assume that this is because each of the modifiers is an AP adjoined to NP and no DegP is involved. This is shown in (23').

- (23') a. a [_{NP} [_{AP} trashy] [_{NP} [_{AP} easy to read] [_{NP} novel]]]
 b. an [_{NP} [_{AP} easy to read] [_{NP} [_{AP} trashy] [_{NP} novel]]]

The contrasts observed in (20) and (22) can therefore be attributed to a DegP intervening between the determiner and the NP.

Another prediction made by this analysis has to do with the extraposition of NP modifiers to the end of a sentence. As (24) illustrates, this is possible for a tensed relative clause.

- (24) a. Jacob gave [a sharp knife which he bought at the flea market]
 to Michael
 b. Jacob gave [a sharp knife] to Michael,
 [which he bought at the flea market]

However, for postnominal infinitives (especially those having associated prenominal adjectives) we find that extraposition is impossible. Consider (25).

- (25) a. Jacob gave [an easy knife to cut figurines with] to Michael
 b.*Jacob gave [an easy knife] to Michael [to cut figurines with]

Under this analysis, (25b) is ungrammatical because the extraposed infinitive contains a trace of the adjective *easy*, and this trace is ungoverned.

- (26) *Jacob gave_[DP] an_[DegP] easy₁ [_{NP} [_{NP} knife] t₂]
to Michael_[AP] t₁ to cut figurines with]₂

This is illustrated in (26), where the trace of *easy* is t₁, and is not governed by its antecedent.

5. Adjective classes and their interaction with infinitives

This section will first propose a four-way classification of adjectives, based in part on a distinction put forward in Lees 1960 and expounded upon in Nanni 1978, and then show how these distinctions lead to slightly different interactions between each adjective class and postnominal infinitives.

Among those adjectives that participate in *tough* constructions, some describe “the work or effort involved in an activity”. These include *tough*, *easy*, *simple*, *hard*, and *difficult*. Others, having a similar (but not identical) distribution, measure “the value or benefit involved in some activity”, and include *good*, *bad*, *annoying*, *nice*, *convenient*, and *interesting*. In addition to appearing in *tough* constructions in which they evaluate the activity or event denoted by the infinitive clause, the latter category can also modify an NP. In this regard, adjectives typified by *good* are ambiguous, while those typified by *easy* are not. Consider (27).

- (27) a. This may be a very good beer, but **I** don't find it good to drink.
b. This may be a very easy book, but **I** didn't find it easy to read.

In (27a), *good* is used in the first instance to mean ‘fine; of high quality; made with good ingredients’. In this use, it is similar to adjectives such as *trashy* (in *a trashy novel*) or *hot* (in *a hot pretzel*). In the second instance it functions as a *tough* adjective, and measures “the value or benefit involved in” the drinking of the beer, suggesting that (while it may be of good quality) it doesn't taste good. In (27b), however, the adjective *easy* has the same meaning in both instances, that of evaluating “the work or effort involved in” reading the book. A three-way distinction among adjective types is further illustrated in the distributional paradigm shown in (28), (29), and (30).

- (28) a. He is an easy person to get to know.
b. He is easy to get to know.
c.*He is an easy person.
d.*He is easy.

- (29) a.*He is a polite person to get to know.
 b.*He is polite to get to know.
 c. He is a polite person
 d. He is polite.
- (30) a. He is a nice person to get to know.
 b. He is nice to get to know.
 c. He is a nice person
 d. He is nice.

In (28), we see that *easy* cannot (by itself) freely modify NPs. In (29), *polite* only modifies NPs, and in (30), *nice* can appear in both contexts. These distributional facts suggest two categories of adjectives (*tough* and NP-modifying), where *good* belongs to both classes, as shown in (31).

(31)	CLASS I: <u>TOUGH</u>	CLASS II: NP-MODIFIER	CLASS I & II: <u>TOUGH</u> & NP-MODIFIER
	easy	trashy	good
	tough	polite	nice
	hard	red	interesting
	difficult	thick	bad
	simple	light	convenient

Yet another, separate, class of adjectives is typified by *likely*. As is apparent from (32), *likely* fits into none of the classes described in (31).

- (32) a.*He is a likely person to get to know.
 b.*He is likely to get to know.
 c.*He is a likely person
 d.*He is likely.

Unlike *easy* which applies to “activities” or *trashy* which modifies NPs, *likely* applies to propositions.⁸

In explaining for the distinctions among these four adjective classes, this account will invoke an analysis of adjective projections first proposed in Abney 1987, and further developed in Bernstein 1993. Bernstein provides good evidence that the APs projected by some prenominal adjectives are complements of D, while others are adjuncts of NP. Some adjectives, such as *poor*, can be either, where the two possibilities correspond to different senses of the adjective. For Bernstein, the adjective *poor* meaning ‘impoverished’ occurs as an NP adjunct, while the adjective *poor* meaning ‘pitiable’ projects an AP complement of D. The two interpretations of the phrase *the poor man* correlate with the two structures shown in (33).

- (33) a. [_{DP} the [_{NP} [_{AP} poor] [_{NP} man]]] (i.e. 'the man is impoverished')
 b. [_{DP} the [_{AP} poor [_{NP} man]]] (i.e. 'the man is pitiable')

Summarizing, the four adjective classes have the following distribution: (i) *easy* projects an AP that can only be an NP adjunct, but it always takes an infinitival complement (although this infinitive is sometimes omitted when understood from context); (ii) the adjectives *good* and *nice* can either be NP adjuncts (as in (33a)) or take NP complements (as in (33b)); (iii) *trashy* and *polite* can only be NP adjuncts (as in (33a)); and (iv) the adjective *likely* takes a clausal complement and can appear in neither of the structures shown in (33).

Looking back, (28c) and (28d) are ungrammatical because *easy* is missing its complement in each case. Turning to (29), since *polite* can only be a prenominal adjunct, and since it does not take complements, it does not license postnominal infinitives. This accounts for the ungrammaticality of (29a) and (29b). Of course, this does not prevent a postnominal infinitive from being licensed from another source, such as a dominating DegP. Accordingly, (34a) is possible (in contrast with (29a)) and has the structure shown in (34b).

- (34) a. The [_{θi}] imported beer to drink is Pacifico.
 b. [_{DP} the [_{DegP} MAX [_{NP} [_{NP} [_{AP} imported] beer] [_{CP} to drink]]]] is Pacifico

(34b) correctly predicts that the adjective cannot appear together with the infinitive, since they are never a constituent. Thus, while *easy to drink beer* is possible, *imported to drink beer* is not.

The adjectives *good* and *nice*, as we have seen, are either NP-adjuncts or take NP complements. This property results in ambiguity in the presence of a postnominal infinitive. The phrase *good book to start a fire with* is ambiguous with regard to whether the book is of good quality and can be used for kindling or whether the book is only good for starting a fire. These two interpretations correlate, respectively, with the representations in (35a) and (35b).

- (35) a. [_{NP} [_{NP} [_{AP} good] book] [_{CP} to start a fire with]]
 b. [_{AP} good [_{NP} [_{NP} book] [_{CP} to start a fire with]]]

In (35b), *good* has scope both over *book* and over the infinitive that restricts it, resulting in the latter interpretation. Notice that, unlike *easy* which moves around the noun to the head of DegP, *good* does not form a unit constituent with the postnominal infinitive in either of its interpretations. Thus, it is possible to have *an easy to burn book* but not *a good to burn book*.

Finally, the properties of *likely* lead us to consider a structure for it that is wholly unlike the other three adjective classes. I would propose that the predicate nominal in (36a) has the structure given in (36b), and is comparable to the raising

construction in (36c).

- (36) a. John is a likely person to win.
 b. John is [_{DP} a [_{AP} likely [_{IP} [_{NP} person] to win]]]
 c. John_i is [_{AP} likely [_{IP} t_i to win]]]

What distinguishes (36b) from (36c) is that the infinitival subject is filled by an NP rather than a DP, an element that does not need Case. The analysis predicts that postnominal infinitives co-occurring with *likely* cannot have an object gap, as (37) demonstrates.

- (37) John is a likely person to hire *(me).

It also accounts rather nicely for the oddity of (32c) without a supporting context.

6. Conclusion

This paper has proposed an account of DegPs which explains the distribution of postnominal infinitives, and accounts for cases in which a “tough”-adjective and an infinitive wrap an NP. It has also provided an articulated classification of adjective types which can explain their interaction with infinitival phrases. While there are still additional facts to consider, it is hoped that this analysis will provide a basis for them as well.

Notes

1. I acknowledge the helpful questions, comments, and criticism from the following individuals: Eric Bakovic, Samuel Bayer, Judy Bernstein, Elizabeth Blount, William Davies, Melissa Dubinsky, Brian Joseph, Richard Kayne, Jeffrey Lidz, Gary Miller, Michael Montgomery, Richard Norwood, Carol Rosen, David Rosen, Karen Stanley, Ioanna Stefanescu, Gregory Ward, Colin Wilson, and audiences at ESCOL '96 and WECOL '98.

2. When postnominal infinitives follow object complement NPs, they are often confounded with purpose clauses. A typical example of such a case is given in (i), where the infinitive is ambiguous between a postnominal infinitive and a VP-modifying purpose clause.

- (i) Marjorie brought a nice toy to play with.

It is possible, however, to filter out purpose clauses by the careful construction of examples. As Berman 1973 and Faraci 1974 point out, *lose* is much less felicitous with a purpose clause than is *bring*. This is clear in (ii).

- (ii) In order to please her friends, Celia brought a cake/*lost a snake.

Where a purpose clause is not possible, constraints on the distribution of postnominal infinitives show through more clearly, as in (iii).

- (iii) Marjorie brought/*lost her nice toy to play with.

Example (iii) is ungrammatical with *lost*, because (1) a purpose clause is ruled out and (2) postnominal infinitives cannot occur in the scope of a possessive pronoun.

3. Not all apparent DegP heads so restrict their complements. Consider the contrast illustrated in (i), where DegP is headed by MAX and *best*, respectively.

- (i) a. The dog to take on a long trip is a golden retriever/?my puppy George.
 b. The best dog to take on a long trip is a golden retriever/my puppy George.

In (ia), *the* needs an emphatic pronunciation to be acceptable, and while the sentence is fine with the type-denoting predicate *a golden retriever*, it is quite odd with the token-denoting DP *my puppy George*. In (ib), though, both type-denoting and token-denoting predicates are possible.

4. In certain cases, superficially similar to (6a), it might appear that a *de re* interpretation is possible.

- (i) Jason was looking for a friend to take his place in the competition.

In (i), however, the object of *looking for* can denote an individual or token only because the infinitival phrase following *friend* is a purpose clause attached to the VP. This becomes evident when we attempt to permute (i) in the manner of (6b).

- (ii) ?A friend to take his place in the competition is what/*who Jason was looking for. Insofar as (ii) is acceptable, it is only under a *de dicto* interpretation.

5. In some syntactic frameworks, such as categorial grammar, syntactic constituency for semantic units is not as critical a factor, since the theory permits structures in which a “constituent” can be wrapped around another expression (see Jacobson 1992 and references cited therein). McCawley (1995) accounts for “discontinuous constituents” by adopting phrase structure representations in which the daughter of a node can precede a node that its mother follows. I will not pursue such alternatives here.

6. The only degree element I am aware of that does not attract adjectives is *such*, which patterns contrary to *so*, as shown in (i).

- (i) a. such a nice man
 b. *such nice a man

However, *such* is also the only one of these which does not require the presence of an adjective in the first place.

- (ii) He is such/*so/*too a fool.

7. Now, the contrast between (17a) and (19a) is amenable to a very straightforward semantic explanation (Peter Lasnik, p.c.). One might simply say that (since a superlative picks out a single individual) once the superlative is added to the NP, any further modification is redundant. Thus, in (19a), *bluest house* picks out the single house which has this property, and the addition of *large* cannot serve to further restrict the reference of the NP. If the data in (19) were ruled out purely for the semantic reason just given, then we would expect that the canonical order should be restored whenever there is no semantic reason to override it. Accordingly, just as two nonsuperlative adjectives observe a canonical order in (16a) and (17a), canonical order should be preserved when both adjectives are superlative. Observe (i).

- (i) a. the largest bluest house b. the bluest largest house

(ia) is, of course, predicted to be grammatical, since the two forms do occur in their canonical order. It is (ib), however, which is unexplained. Each superlative serves to single out one house, and the combination of the two superlatives is additive, and serves to indicate that the single house picked out by *largest* is the same individual as the one picked out by *bluest*. There is therefore no reason under these circumstances for canonical order not to be retained, since there is no semantic reason for overriding it. In accounting for the data in (i), this analysis needs only to make the straightforward assumption that *-est* can be introduced

recursively.

8. Now, being a modifier of propositions does not in and of itself allow an adjective to appear in an “adjective + NP + to + VP” phrase. Only raising adjectives such as *likely* can do so. Consider the facts in (i).

- (i) a. John is likely/*possible to know the answer.
- b. John is a likely/*possible person to know the answer.
- c. It is likely/possible that John knows the answer.
- d. That John knows the answer is likely/possible.

Both *likely* and *possible* predicate propositions, as (ic) and (id) clearly show. However, only *likely* permits an infinitival complement, which is why (ia) and (ib) are ungrammatical with *possible*. Unlike some of the other contrasts discussed above, the different distribution of *likely* and *possible* has no obvious semantic correlate.

References

- Abney, Steven. 1987. The English noun phrase in its sentential aspect. Doctoral dissertation, MIT.
- Berman, Arlene. 1973. Adjectives and adjective complement constructions in English. Doctoral dissertation, Harvard University, Cambridge, Mass.
- Bernstein, Judy. 1993. Topics in the syntax of nominal structure across Romance. Doctoral dissertation, CUNY.
- Christoffersen, Paul. 1939. *The articles: A study of their theory and use in English*. Copenhagen: Einar Munksgaard.
- Epstein, Richard. 1994. Discourse and definiteness: synchronic and diachronic perspectives. Doctoral dissertation, University of California, San Diego.
- Jacobson, Pauline. 1992. “Flexible categorial grammars: Questions and prospects,” in Robert Levine (ed.), *Formal grammar: Theory and implementation*, 129-167. Oxford: Oxford University Press.
- Faraci, Robert. 1974. Aspects of the grammar of infinitive and *for* phrases. Doctoral dissertation, MIT.
- Lees, Robert. 1960. “A multiply ambiguous adjectival construction in English,” *Language* 36.2:207-221.
- McCawley, James. 1995. “Discontinuous constituent structure.” Unpublished manuscript, University of Chicago.
- Nanni, Debbie. 1978. The easy class of adjectives in English. Doctoral dissertation, University of Massachusetts, Amherst.
- Quirk, Randolph, Sidney Greenbaum, Geoffrey Leech, & Jan Svartvik. 1985. *A comprehensive grammar of the English language*. London: Longman.
- Wells, Rulon. 1947. “Immediate constituents,” *Language*, 23.1:81-117.

Stanley Dubinsky
University of South Carolina
Linguistics Program
Columbia, SC 29208
dubinsky@sc.edu

‘Porque sí’: the Acquisition of Discourse Markers in Spanish.

Pilar Durán

Boston University

1 Introduction

Research on Language Development has immensely enriched our understanding of children’s acquisition of lexicon and syntax. However, it takes more than the acquisition of vocabulary and grammar to become competent in a language. This paper will look at one aspect of coherence, namely, the use of discourse markers in the earliest stages of language development in Spanish speaking children.

Discourse markers (DMs) are elements that mark the relationship between the segment of discourse that the marker introduces with a prior segment of discourse. DMs as connectors of discourse segments can mark speakers’ turns, speech acts, or they can connect ideas. Since DMs mark the relationship between segments of discourse, they are indicators of discourse coherence. Coherence is defined as the integration of discourse segments as a whole.

This study will focus on the acquisition of five Spanish discourse markers: **y** (and), **porque** (because), **pero** (but), **pués** (well, so), **entonces** (then, so) by four Spanish speaking children whose transcripts are in the CHILDES database.

‘**Y**’ (and)- coordination.

‘**Porque**’ (because)-reason. It signals a causal relation between two discourse segments.

‘**Pero**’ (but)-contrast. It marks a contrast between two segments.

‘**Pues**’ (well, so)-marker of response or result.

‘**Entonces**’ (so, then)-result or temporal sequence.

The research questions are:

1. At what age and in what order do children start producing these discourse markers?

The answer to this question will be divided in two: the age of first appearance of DMs, and the age of productive use of these markers.

2. What is the relation between the level of language development and the use of discourse markers by children?

3. Which functions do discourse markers have in child language?

In order to answer this question, I will use Schiffrin's approach to DMs' functions.

2 Methodology

The subjects belong to longitudinal studies of four Spanish speaking children whose transcripts are available in the CHILDES database. Their ages range from 1;4 to 4; 8 months old. Their data correspond to spontaneous speech. Children were recorded while enrolled in family activities.

To answer the research questions, I used several CLAN programs available through CHILDES (MacWhinney 1995).

3 Results and Discussion.

Question 1: At what age and in which order do children start to produce the DMs?

In order to answer this question, I used the freq program from the CHILDES. Results are presented in **Table 1**.

Table 1. Age of **first appearance** of the Spanish Discourse Markers

	y	porque	pero	pues	entonces
JUA	1;9	2;4	4;4	4;7	2;5
KOK	1;9	2;2	2;5	2;11	2;5
MAR	1;9	2;1	2;0	2;3	2;5
EDU	3;1	3;1	3;10	3;10	

Note that the blank space for 'entonces' in EDU means that 'entonces' did not appear in the child's data.

In Table 1, we observe that the first DM to emerge was 'y', at the age of 1;9 except for EDU at 3.1. The second DM was 'porque', except for MAR whose second DM was 'pero'. The rest 'pero', 'pues', 'entonces' emerged in different order depending on the child.

Table 1 also shows that before the age of 2;6 months old, all DMs had appeared in the Spanish data, used by one at least one child. In addition, by the same age of 2;6 months old all children were using a variety of DMs, with the exception of EDU.

The productive use of DMs is represented in **Table 2**.

Table 2. Age of **productive use** of Discourse Markers.

	y	porque	pero	Pues	entonces
JUA	2;1	3;6		4;7	
KOK	1;9	2;4	2;5		
MAR	1;9	2;1	2;3	2;3	
EDU	3;10	3;1			

By productive use, we mean that once a DM appears, the child uses it in the subsequent recordings or there is a high number of uses of that marker in one file. Note that blank space means that the DM was not used productively in the child's data.

By looking at Table 2, we can see that 'y' and 'porque' were used productively by all subjects. 'Pero' and 'pues' were used productively only by some subjects. And finally, 'entonces' did not seem to be used productively by any subject.

Another result observed by using freq was the high frequency of uses of 'y' in comparison with the other DMs.

These results are confirmed in the literature. The fact that 'y' or 'and' is the most frequent and the first DM to emerge was observed by Bloom et al., and Hood et al. in their study of the acquisition of English connectors, and by Clancy et al. in their crosslinguistic study of the acquisition of connectors.

The order of emergence in these studies is also similar to the one observed in the present study of Spanish DMs.

It is important to notice that even when children are using 'y' or 'and' as their only discourse marker, they are creating coherence in discourse.

Question 2: What is the relation between the level of language development with the use of DMs by children?

In order to answer this question, I calculated the mlu of the children under study.

Table 3 presents the relation between mlu and the first appearance of DMs.

Table 3. Relation between mlu and the first appearance of DMs.

	JUA			KOK		MAR			EDU	
	level 1	level 2	level 3	level 2	level 3	level 2	level 3	level 4	level 1	level 2
y	0	31	156	14	288	37	40	79	1	45
porque	0	1	15	2	52	10	6	32	1	5
pero	0	0	2	0	26	2	10	17	0	2
pues	0	1	13	0	1	1	8	24	0	2
entonces	0	1	6	0	4	0	0	3	0	0

Note: Level 1=1 to 2 words per utterance; Level 2=2 to 3; Level 3=3 to 4; Level 4=4 to 5.

Notice that the levels of language development in Table 3 used in this study are slightly different from Brown's stages of development¹.

We can't make general claims because of the limits of the data but Table 3 seems to suggest that the first level in which DMs emerge for the first time is Level 2, with the possibility of Level 1 because of EDU's production of 'y' and 'porque' at this level. In addition, we can observe that all DMs appeared at least once at this level 2 in the data.

This section shows that once children have an average of 2 or more words per utterance, they start using DMs. Since DMs are indicators of discourse coherence, we can conclude that children make the discourse coherent since very early levels of language development.

Question 3: Which functions do DMs have in child language?

In order to answer this question, I used the *kwil* command in the CLAN program which helped me to check the distribution of DMs in the Spanish data. The result of the analysis of the data is that as soon as Discourse Markers emerge, children use them with different functions.

Functions are coded according to Schiffrin's approach: in ideational structures (local and global), in action structures, and in exchange structures:

Ideational structures: they are propositions, or what Schiffrin calls ideas. Ideas are related to form one ideational structure "when the interpretation of an element in a clause presupposes information in a prior discourse". Ideas are also related to form one ideational structure through the "organization of the topics and subtopics-what is being talked about". Ideas are also related through the role they "play *vis-a-vis* with one another, or within the overall text" (Schiffrin 1988). In addition, these ideational structures can function at the **local level**, when the idea of one clause is connected only to the idea of the clause immediately preceding it; and at the **global level** when the idea of one clause is

¹Brown proposed five MLU stages: Stage I (1.0-2.0 words per utterance); Stage II (2.0-2.5); Stage III (2.5-3.0); Stage IV (3.0-3.5); Stage V (3.5-4.0).

connected to the idea present in a discourse segment other than the clause immediately preceding it.

Action structures: “speech acts are situated (...) in terms of what action precedes, what action is intended, what action is intended to follow, and what action actually does follow” (Schiffrin 1988).

Exchange structures: they are turns, but “they also include conditionally relevant adjacency pairs—in other words, questions and answers, greetings.” (Schiffrin 1988)

Let me introduce and analyze some of the first uses of Spanish DMs by the four Spanish speaking children under study:

1. KOK: voy a dejarlo aquí.
 go-1s to leave-it here
 (I am going to leave it here)
 MOT: buena
 good girl
 KOK: y voy a bailar
 and am-1s going to dance
 (and I am going to dance)

(KOK, level 2; 2;4)

(ideational structure at the local level)

In this example, ‘y’ is relating two ideas in an ideational structure at the local level. These two ideas refer to the activities that the child is carrying on at that moment. ‘Y’ marks the temporal sequence between the two activities. In addition, since the idea of the clause introduced by ‘y’ is connected only to the idea of the clause which immediately precedes it, this ideational structure works at the local level.

2. KOK: eso son basura
 that are garbage
 (they are garbage)
 MOT: son basura?
 are they garbage?
 KOK: no hay que come(r)las
 not need to eat them
 (We can’t eat them)
 MOT: no?
 KOK: no, porque son basura.
 no, because are-3p garbage
 (no, because they are garbage)

(KOK, level 2; 2;2)

(ideational both at the local and global levels)

In number (2), 'porque' marks a causal relationship between different ideas in the conversation. We have two different ideational structures, one is at the local level and the other at the global level. At the local level, the 'porque' clause 'porque son basura' gives a reason for the immediately preceding negation. Notice that in addition to its relation to the negation, the clause which gives the reason is also related to the first sentence of the example. The child went back to her initial statement 'son basura'. With the latter relation, an ideational structure at the global level is created.

3. MAD: este libro es tuyo o de mamá?
this book is yours or mom's?

MAR: es el de mamá, pero me lo dejas un poquito
Is mom's, but me it lend-2s a little
(it's mom's, but you will lend it to me for a while)

(MAR, Level 2; 2;3)

(action structure and ideational structure at the local level)

'Pero' in (3) marks the contrast between two ideas: first, who the possessor of the book is, and second, the child's desire of having the book for a little while even though the book is not hers. This contrast is at the local level because it works between clauses that are next to each other. 'Pero' also marks an action structure. With the clause introduced by 'pero', the child is presenting a request for the book. The request is in contrast with the answer to the question.

4. PAD: ¿Qué le vas a hacer al muñeco?
What are you going to do to the doll?

MAR: no sé, pues una pupa
no know-1s well a booboo
(I don't know, well a booboo)

(MAR, Level 2; 2;1)

(exchange structure and ideational structure at the local level)

In (4), 'pues' functions in an exchange structure and in an ideational structure at the local level. In the exchange structure, 'pues' connects the adjacency pair of question and answer by marking the relevant portion of the answer. In the ideational structure, 'pues' relates the idea of the answer with the idea of the question. Notice that 'no sé' here is not considered a clause but a routine, an aside comment which does not add any referential meaning to the discourse. Therefore, the clause immediately preceding the clause with 'pues' is the question of the PAD, not the 'no sé' comment.

The last DM 'entonces' (then, so) was mainly used by all the children in a story telling context.

5. KOK: <el a> [//] el oso el oso se fueron [?] .
 <the a> [//] the bear the bear were gone
 KOK: el oso chiquitito no quiere caminar .
 the little bear does not want to walk
 KOK: porque está cansado .
 because he is tired
 KOK: 0 [=! laughs] .
 MOT: y entonces ?
 and then?
 KOK: entonces el oso # grande está <enojado &o &o> [% singing] .
 then the big # bear is <angry &o &o> [%singing]
 MOT: y entonces ?
 and then?
 KOK: en [//] y [/] y entonces qué ?
 in [//] and [//] and then what?
 MOT: el oso está enojado, y qué le hace a (e)l osito chiquitito ?
 the bear is angry, and what does he do to the little bear?

(KOK, Level 3, 2;5)

In (5), the first 'entonces' relates the reference to different events in the course of the narrative in an ideational structure. It relates 'el oso chiquitito no quiere caminar' with 'el oso grande está enojado'. The second 'entonces' in (5) marks an action structure as well as an ideational structure. In the ideational structure, the DM marks a relation between a sequence of references to different events: that 'el oso grande está enojado' with the subsequent event that the child doesn't know and that's why she asks her mother 'y entonces qué'. In the action structure, the child changes her role of story teller by passing the turn to the mother with a request for her mother to continue with the story. With respect to the levels of the ideational structures, in both uses of 'entonces', ideas are connected in ideational structures at both local and global levels. The clauses with 'entonces' are connected as mentioned before with ideas present in segments further away in the discourse than the immediately preceding clause. Moreover, the fact that the child is telling a successive sequence of events signalled by the repeated use of 'entonces' brings the whole narrative together creating an ideational structure at the global level. In addition, the ideas of the clauses with 'entonces' are connected with the ideas of the question immediately before them, marking the connection of ideas within ideational structures at the local level.

In this section, I have shown that as soon as children start using DMs, the markers appear with a variety of functions. These results contrast with the results that Sprott (1992) found in his study of arguments in early English. He claims that children started by using the DMs in exchange structures and that ideational structures at the global level were the last structures in which DMs appear in the course of language development. These claims do not seem to correlate with my findings in the Spanish data. However, my findings have been confirmed by the study of narrative in children from 3;6 to 9;6 years old by McCabe and Peterson. They found that in children's narrative "(f)ully three-quarters of their clauses are linked by connectives, mostly by *and*". Moreover, they found that the discourse markers they studied (then, because, so, but, and and) were used with different semantic and pragmatic roles.

4 Conclusions

My study of Spanish data show that children are creating coherence even from very early levels of language development. Even when children are using 'y' as the only DM, they are making the discourse coherent, by connecting turns, actions, and ideas. In addition, this paper has argued that as soon as children can produce utterances with two words, they make use of overt lexical items, namely DMs, which serve to connect discourse segments.

5 References

- Bloom, L., Lahey, M., Hood, L., Lifter, K., & Fiess, K. 1980. "Complex sentences: acquisition of syntactic connectives and the semantic connection they encode." *Journal of Child Language*, 7.,235-261.
- Bodin, L and Snow, C. 1994 "What kind of a Birdie is This? Learning to use superordinate." *Handbook of Research in Language Development Using CHILDES*. Hillsdale, NJ: Lawrence Erlbaum.
- Claney, P., Jacosen, T., Silava, M. 1976. "The acquisition of conjunction: a crosslinguistic study." *Paper & Reports on Child Language Development*. 12, 71-80.
- Eissenberg, A. R. 1980. "A syntactic, semantica, and pragmatic analysis of conjunction." *Paper & Reports on Child Language Development*, 19, 70-78.
- Fraser, B. "What are discourse markers?" to appear in *Journal of Pragmatics*.
- French, L., & Nelson, K. 1985. *Young Children's Knowledge of Relational Terms: Some ifs, ors, and buts*. New York: Springer-Verlag.
- Gleason, J. B. 1997. *The Development of Language*. 4th ed. Needham Heights, MA: Allyn and Bacon.
- Hood, L., Lahey, M., Lifter, K., & Bloom, L. 1978. "Observational, descriptive methodology in studying child language: Preliminary results on the development

of complex sentences.” In G. P. Sackett Ed., *Observing behaviour, Vol 1: Theory and Application on Mental Retardation* pp. 239-263. Baltimore: University Park Press.

MacWhinney, B. 1995. *The CHILDES Project: Computational tools for analysing talk*. Hillsdale, NJ: Lawrence Erlbaum Associates.

Montes, R. 1987. *Secuencias de clarificación en conversaciones con niños*. Morphe 3-4: Universidad Autónoma de Puebla.

Montes, R. 1992. *Achieving understanding: Repair mechanisms in mother-child conversations*. Unpublished doctoral dissertation, Georgetown University.

Peterson, C., & McCabe, A., 1991. “Linking children’s connective use and narrative macrostructure.” In Peterson, C., & McCabe, A., eds *Developing Narrative Structure*. Hillsdale, NJ: Lawrence Erlbaum.

Pons, S. 1997 “A Prototype Approach to the Concept of Connective”. Unpublished ms. University of Valencia.

Pons, S. 1998 “Landmarks for a Map of the Spanish Connectives.” Unpublished paper.

Redeker, G. 1990 “Ideational and pragmatic markers of discourse structure.” *Journal of Pragmatics*. **143**: 367-81.

Sokolov, J and Snow, C. 1994 *Handbook of Research in Language Development Using CHILDES*. Hillsdale, NJ: Lawrence Erlbaum.

Schiffring, D. 1988 *Discourse Markers*. Cambridge: Cambridge University Press.

Sprott, S. 1992 “Children’s use of discourse markers in disputes: Form-function relations and discourse in child language.” *Discourse Process: A Multidisciplinary Journal*. Norwood, HJ DPr.

Pilar Durán, Boston University, pduran@bu.edu

The Structure of a Lexicon: Navajo (and other) Verbs

Leonard M. Faltz
Arizona State University

1 Introduction

The point of view I wish to operate from in this article is the idea that a lexicon is (or has) a kind of grammar of its own. In its simplest conception (as expounded in early versions of formal grammar), a lexicon is a set of items each of which embodies a pairing of a semantic/cognitive unit with a string of phonological units, augmented with whatever grammatical features (such as syntactic categories) are needed for the syntax and morphology, and possibly including links to other lexical items. But real lexica involve much more structure than this. Our purpose here is to examine the sorts of structure that a lexicon can have, ultimately towards the goal of creating a universal theory of the lexicon which can serve as the basis of lexical typology.

Now, typological studies are typically carried out by comparing features of languages that differ with respect to their interaction with other features of languages that are universally definable. For example, the simplest typologies, investigated decades ago, consisted of word-order patterns involving notions like “subject”, “object”, and “verb”; but only on the basis that these notions were universally definable could word-order types such as SOV, SVO, etc. be regarded as having validity. Later studies developed more articulated notions of, for example, “subject”, and typologies based on more abstract notions often represented by means of parameters defined with respect to abstract syntactic structures, were developed. In these theories, the general structuring mechanisms (including principles that constrain them) are assumed to be universal.

In this paper we use the Navajo verb lexicon as a starting point to investigate issues in the structure and typology of the lexicon. In the typological developments outlined above, the role played by the lexicon was sometimes nonexistent (as in the old word-order typologies). The notion of lexicon often found in theoretical studies, as suggested above, presupposes that the notion “lexical item” is universally definable, but even a cursory examination of the lexical structure of a language shows that lexical units exist at different levels of

structure. This raises the issue of how such levels are to be defined, as well as the issues of how they are related to each other on the one hand and to various semantic/cognitive domains on the other. The Navajo verb lexicon is particularly suited to a study of such matters since it has been well described, since it is reasonably complex, and since it exhibits significant differences from the lexica of more familiar European languages.

Our discussion will proceed as follows. We use morphological and grammatical categories to define levels at which lexical units of the Navajo verb lexicon reside. We describe the combination of units at various levels by means of unification. We associate a cognitive type with each level. Finally, we note that the facts we have found lead to consequences concerning the sorts of lexical items that a language can have.

In this study, we are chiefly interested in derivational issues. However, it will be necessary to make reference to inflection in order to clarify the morphology of the Navajo verb so that we can tease apart the derivational categories and levels that we are attempting to discover.

2 A First Pass

So let's start by familiarizing ourselves with the morphological and grammatical categories that are involved in verb formation. To do this, we'll look carefully at one particular verb. We want to see what categories are manifested in this verb, and what items can represent these categories.

The word in (1) means something like: "you (sg) (are about to) club him/her".¹

(1) náííłhhaaʔ.

The inflectional categories which are marked in the form in (1) are the following:

- (2) (a) The subject is 2 person singular.
- (b) The object is 3 person.
- (c) The mode is Imperfective.²

To see how these are marked, we need to unpack the word in (1) into its constituent parts. These are shown unlabelled in (3) (we'll examine each piece carefully in a moment):

(3) ná - ∅ - d - ii - ł - ghaaʔ

The category values given in (2) are marked by the elements shown in (3) as follows.

The fact that the subject is 2 person singular is shown by using a 2 person singular subject prefix, which appears in (3) as the morpheme -ii-.

The fact that the object is 3 person is shown by using a 3 person object prefix, which is the zero morpheme in this case, shown in (3) in the position that object prefixes normally appear.

The fact that the mode is Imperfective is simultaneously marked in two ways.

To see what the first way of marking the Imperfective mode is, we note that the last element of any verb is the verb stem. In (3), for example, the verb stem is ghaaʔ. However, verb stems actually come in stem-sets, with one stem for each mode. The verb stem in (3) (namely ghaaʔ) is the stem used for the Imperfective mode. Slightly different forms of this stem are used for the other modes; for example, if the mode were Perfective, we'd find the stem ghaal; if the mode were Future, we'd find the stem ghaʔ, etc.

The second way of marking the mode resides in the subject prefix. Different sets of subject prefixes are used for different modes. The 2 person singular subject prefix -ii- that we see in (3) is a member of the set of subject prefixes used for the Imperfective mode. Different 2 person singular subject prefixes are used in other modes.

Having picked out the inflectional signals from (3), we are now tempted to say that the rest of the elements of (3) constitute the lexical verb whose meaning is (roughly) "to club someone/something". These elements are, then,

- (4) (a) The set of stems of which the stem -ghaaʔ is the member used for the Imperfective mode.
 (b) The remaining prefixes in (3), namely ná, d, and ʔ.

3 Atomic Lexical Elements

As it happens, the situation is more complicated. Let's examine the details, starting from the right side of (3).

First, the stems. The actual stems used for the verb in (1) in the various modes are listed in (5):

- (5) Imperfective: -ghaaʔ
 Perfective: -ghaal
 Future: -ghaʔ
 Iterative: -ghaʔ
 Optative: -ghaaʔ

We might want to say something like this: the Navajo lexicon includes a number of stem-sets such as the one in (5); and any particular verb uses one such set. The problem with this idea is that there are verbs that are obviously

derivationally related to the one in (1) which use a stem-set that is extremely similar to, but not exactly the same as, the one in (5). For example, there is a verb that means "to give someone/something a beating with a club" which uses the stem-set in (6):

- (6) Imperfective: -ghat
 Perfective: -ghaal
 Future: -ghat
 Iterative: -ghat
 Optative: -ghat

The situation seems to be that stem-sets cluster into small derivational groups. In most cases, the Perfective mode stem of the various sets in any one such group are the same; for example, the Perfective stem in (5) is the same as the one in (6), namely -ghaal. For this reason, it has become customary to label a group of related stem-sets by the common Perfective stem. In the case we've been looking at, we can say that the sets in (5) and (6) are both members of one group of sets which we will denote GHAAL. Such a group, named by its perfective stem, is called a *root*.

So, in the case of our verb in (1), what we need to say is that the stem-set used by this verb is one of the sets belonging to the root GHAAL. It is common in Navajo studies to label the sets belonging to one group using terminology that suggests aspect; for example, the stem-set in (5) is called the *momentaneous* stem-set of the root GHAAL, whereas the one in (6) is called the *repetitive* stem-set of this root. Because of this aspectoid terminology, I call the category classified by such terms *stem-aspect*. To summarize: to specify the stems used by any particular verb, we need to specify what root it takes its stems from, and what stem-aspect it uses. In the case of our verb in (1), we'll say that it uses the momentaneous stem-set of the root GHAAL.

By doing this we have made the acquaintance of an important level of the lexicon, namely the level *root*. The Navajo verb lexicon provides something of the order of five or six hundred roots. We will use the term *major lexical level* to denote a level inhabited by a relatively large number of elements (large enough to suggest that brute memory is needed by the learner of the language to master them.) Thus, the root level is a major lexical level.

In contrast, there are perhaps half a dozen stem-aspects. The system which they constitute suggests a grammatical rather than a lexical level; in fact, it is more comfortable to regard stem-aspect as a category rather than a level, because of this. Note, though, that the grammar involved is derivational, not inflectional, and hence is best regarded as forming a part of the lexicon. In addition to the notion of stem-aspect, we will meet two other grammatical-like categories that are part of the derivational system of Navajo verbs. In this

article, we will use the term *grammatical/derivational category* to apply to these categories. Thus, stem-aspect is our first grammatical/derivational category.

Before further analyzing the roles of roots and stem-aspects, let's progress leftward through the elements in (3) to see what other constituents there are in the lexical verb that means "to club someone/something".

The consonant *ʔ* that we see immediately to the left of the stem is one of a set of four elements known as *classifiers*, the other three being: *l*, *d*, and *∅* (zero). We'll return to this category later; for now, let's just say that each verb requires that one of these four classifiers appear in the position immediately preceding the stem. Since there are precisely four members of this category, this is not a major lexical level; like stem-aspect, it is a grammatical category, but also like stem-aspect, the classifier is a derivational unit. In fact, the classifier is our second example of a grammatical/derivational category in the Navajo verb lexicon. Note, by the way, that since the classifier is NOT an inflectional unit, the same classifier appears in all inflected forms of any one verb.³

Preceding the classifier we have the 2sg subject prefix *ii*, an inflectional element that we've already mentioned. In fact, we already pointed out that different sets of subject prefixes are used for different modes, so that this prefix also comports within it the fact that the form in (1) is in the Imperfective mode. However, it turns out that in addition to the subject registration and mode registration associated with this prefix, there is also a grammatical/derivational category hidden in it. The story is as follows.

For the moment, let's restrict our attention to the Imperfective mode only. We said earlier that each mode has its own set of subject prefixes. This would lead us to think that the Imperfective mode has one set of subject prefixes. But in fact, this mode has FOUR sets of subject prefixes, which we will call the regular-I, n-I, s-I, and long-vowel-I prefix sets.⁴ The choice of which set to use is a derivational matter. As it happens, the verb in (1) uses the long-vowel-I subject prefixes in the Imperfective mode.

To complete the story, we need to look at the other modes. It turns out that they too have more than one set of subject prefixes. The exact number of prefix sets per mode depends on the mode: some modes have two sets, some three, and some four. Thus, it automatically cannot be the case that the prefix sets fall into mode-independent classes, although some cross-mode connections can indeed be made. More terrifyingly, two verbs might use the same subject prefix set for one mode but different sets for another mode, leading potentially to a huge number of distinct possibilities for the subject prefix sets that a speaker would need to memorize for a particular verb. Fortunately, the real situation is much simpler: there are only eight possible collections of subject prefix sets (one per mode) that any (regular) Navajo verb can use. In the case of the verb in (1), the subject prefix sets are as follows. In the Perfective mode, the so-called y-P subject prefix set is used; in the Future mode, the regular subject prefix set is used, and in all the other modes, the long-vowel subject prefix set is used. To be

able to refer to this combination of subject prefixes, we'll say that any verb carries a grammatical/derivational category called *conjugation pattern*. Let's use the mnemonic YLV to name the particular conjugation pattern used by the verb in (1); as we said, this is one of eight possible conjugation patterns.⁵

Since there are only eight members of this category, conjugation-pattern is not a major lexical level. In fact, the conjugation-pattern category is our third derivational/grammatical category, along with stem-aspect and the classifier.

The remaining elements shown in (3) are the prefixes *d* and *ná*. (The object prefix, which is \emptyset (zero) in this case, is not only an inflectional element, but in fact a rather easy inflectional element, in that, unlike the situation with the subject prefixes, there is one set of object prefixes used for all modes and for all verbs that take objects.) These prefixes are best viewed as members of a moderately large set of derivational prefixes, with varying specificities of meaning, that can be tapped for creating verbs. We see from our example that a verb can have more than one derivational prefix. In fact, verbs exist with no derivational prefixes, or with one or more such prefixes. There does not seem to be a clear upper limit to the number of prefixes a single verb can have, although there are practical limits. Verbs with three derivational prefixes are certainly common enough.

Because the Navajo verb lexicon provides a large set of derivational prefixes, we will regard the derivational prefixes as inhabiting a major lexical level.

We now have surveyed all the fundamental lexical elements which define the verb in (1). Summarizing, we can say that, ignoring inflectional specifics, this verb is defined by the following elements:

(7)	root:	GHAAL
	stem-aspect:	momentaneous
	classifier:	†
	conjugation-pattern:	YLV
	prefixes:	<i>ná</i> , <i>d</i>

The five entries in (7), namely the two major lexical levels (root and prefixes) together with the three derivational/grammatical categories (stem-aspect, classifier, and conjugation-pattern) constitute the five *atomic* categories of the Navajo verb lexicon. They are atomic in the sense that none of them is composed of more primitive categories. Any lexical verb in Navajo can be described by giving appropriate values for the five slots listed in (7).⁶

4 Non-Atomic Lexical Elements

We might be tempted to stop at this point and regard the Navajo verb lexicon as completely describable on the basis of what we've done so far. In one sense this

is true: if we list all the roots and all the prefixes, we can create a list of structures such as the one in (7) which will constitute a list of all the lexical verbs of the Navajo language. The problem with this is that there are other levels at which lexical units exist. These other levels exist by virtue of the fact that they are inhabited by structures with clear semantic and cognitive associations, structures which themselves must be regarded as elements out of which verbs are built. Let's illustrate this using our example in (1)/(7).

First of all, we have already seen that to describe the various forms of the verb of which the word in (1) is one illustration requires stating the stem-set, that is, the set of stems used for each mode. And we have seen that the stem-set is defined exactly on the basis of two of the categories in (7), namely the root and the stem-aspect. Thus, on purely morphological grounds, it would make sense to articulate the structure in (7) further, as follows:

(8)	stem-set:	
	root:	GHAAL
	stem-aspect:	momentaneous
	classifier:	†
	conjugation-pattern:	YLV
	prefixes:	ná, d

The structure in (8) shows *stem-set* as a lexical level, but not an atomic one. It is a major lexical level, since it is inhabited by a large number of members, but it is not atomic, since any member at this level is defined by elements taken from two other levels, themselves atomic. Anticipating later discussion, let's note that although the stem-set level is of crucial morphological importance, since it is at this level that the forms of the stems actually used in the verb reside (the actual stem-set defined in (8) is shown earlier in (5)), this level, in itself, appears to NOT be of significant semantic importance.

Next, it turns out that the combination of the root and the classifier in (7) constitutes a definable unit of the Navajo verb lexicon. This unit, called a *theme*, exists by virtue of the fact that a fundamental semantic content can be associated with it, and hence it is found as a combinatorial element in many lexical verbs.⁷ In the case of the theme embedded in (7), we can identify its meaning as roughly "to act with a clublike object". Using the concept of theme, we can articulate the structure in (7) as follows:

(9)	theme:	
	root:	GHAAL
	classifier:	†
	stem-aspect:	momentaneous
	conjugation-pattern:	YLV
	prefixes:	ná, d

Comparing (8) and (9), we already see something interesting: the internal lexical structure of a verb as viewed by the morphology does not have the same architecture as the internal lexical structure of a verb as viewed by the semantics: morphologically, the root determines the stem-set (together with the stem-aspect category), whereas derivationally the root determines the theme (together with the classifier.) This mismatch is not peculiar to the Navajo language – we expect to find similar mismatches in the lexica of all languages.

But we are not finished with the verb in (1). There is another lexical unit present in it, namely the combination of stem-aspect, conjugation-pattern, and the lexical prefixes in that verb. We will call the level defined by these elements *satellite*. Using this new level, we can further refine the structure in (9) as follows:

(10)	theme:	root:	GHAAL
		classifier:	†
	satellite:	stem-aspect:	momentaneous
		conjugation-pattern:	YLV
		prefixes:	ná, d

Like the theme, the satellite diagrammed in (10) exists as a unit by virtue of the fact that a semantic value can be given to it, and that it occurs as a combinatorial unit in a significant number of lexical verbs. The meaning of the satellite in (10) is roughly “to strike someone/something once by means of the action denoted by the theme”. Since the Navajo verb lexicon provides a considerable number of such satellites, we consider the satellite level to be a major lexical level in the Navajo verb lexicon.

We have now made the acquaintance of five major lexical levels of the Navajo verb lexicon, namely: root, prefix, stem-set, theme, and satellite. The first two are atomic. We will suggest only one more major lexical level in our analysis here. Further articulation of the system will be left to later work.

5 Lexical Entries

Before proceeding, it will be handy to divide the five major levels that we’ve seen into two groups, as follows. We notice that the choice of a root, a stem-set, or a theme determines the choice of a verb stem in a significant way. Viewing the verb stem as the morphological head of a verb form, we’ll call these three levels *head levels*. On the other hand, the choice of a prefix or of a satellite either has no effect on the verb-stem, or else (as mediated by the stem-aspect category) has what is intuitively only a modifying effect on a verb-stem that has

already been chosen. Thus, these two levels will be called *non-head levels*. The intuition here is that a lexical item chosen at a head level is in some sense a verb-like entity, whereas a lexical item chosen at a non-head level is not in itself verb-like.

Anticipating a later comment, we note at this point that the meaning of the satellite in (10) is one which in many languages is expressed by means of a verb or verb-like element, whereas in Navajo this meaning appears at the non-head satellite level.

If we compare the structure diagrammed in (8) with the one diagrammed in (10), we see that the partitioning of the elements of a verb will be different according to whether we are interested in the morphology or in the derivational structure of the verb. If we imagine that the Navajo verb lexicon consists in part of a list of themes and a list of satellites, it would appear that a lexical verb is constructed by choosing a theme and a satellite and combining them as shown in (10). But to determine the actual forms of the verb, a representation such as the one in (8) is better, since that representation corresponds directly to the actual morphology of the verb forms. Approximately following the traditional terminology, let's call the sort of structure shown in (8) a *verb base*. If we imagine, then, that a lexical verb should (at the morphological level) have the structure of a verb base, as shown in (11):

- (11) verb base:
 stem-set
 classifier
 conjugation-pattern
 prefixes

where, "stem-set" has the structure shown in (12):

- (12) stem-set
 root
 stem-aspect

then we can create structures like (11) and (12) starting from a theme with a structure as in (13):

- (13) theme:
 root
 classifier

and a satellite with a structure as in (14):

- (14) satellite:
 stem-aspect
 conjugation-pattern
 prefixes

by assuming a generalized notion of unification: to create a verb base, each field in (13) and (14) is copied into the appropriate slot in the structures (11) and (12). As long as there is no conflict,⁸ the unification succeeds and a verb base results. In the case of a conflict, we expect to say that the elements cannot unify to create a verb base; but in certain cases, additional principles will have to be invoked.

In general, mismatches between formal structures at different levels are commonly found in all sorts of contexts in language structure, so we should not be surprised to find a mismatch between the morphologically-based structure of a lexical verb and its derivationally-based structure.

We have now met all of the levels of the Navajo verb lexicon. The major levels are: root, theme, stem-set, prefix, satellite, and finally verb base, the latter being the level which contains the elements that most clearly correspond to lexical entries for verbs. (The verb base level is of course a head level, i.e. a level at which the elements are intuitively verb-like.) We also have met three derivation/grammatical categories, namely classifier, stem-aspect, and conjugation-pattern. Finally, we have seen how all of these categories and levels are formally related to each other. This puts us in a position to state the basic principles of verb formation in the Navajo lexicon:

- (15) A lexical entry in the Navajo verb lexicon consists of an element which can be morphologically described as a verb base (as diagrammed in (11)) and derivationally described as the unification of a verb theme (as diagrammed in (13)) with one or more satellites (as diagrammed in (14)).⁹

6 Semantic Linkages and Some Typology

But this is not the whole story. Minimally, we need to study the linkages between the levels and categories of the lexicon and levels of cognitive/semantic units. We've already brushed against a few examples of this; now let's take a closer look.

First, we expect that semantic sense can be made of the system outlined in (15) by examining the derivational rather than the morphological structure of a verb; at least, we will proceed on this assumption here. One immediate consequence of this is that the stem-set level does not correspond to any semantic/cognitive

level, since the stem-set level exists only on the morphological side of a lexical entry ((11) and (12)) but is absent from the derivational side ((13) and (14).)

Next, we note that the specificity, and hence the possible clarity of definition, of the semantic or cognitive unit associated with an element at any level is highest at the verb base (i.e. lexical entry) level, and diminishes as we work our way down to the atomic levels and the grammatical/derivational categories. For example, the verb base in (8), which corresponds to the derivational structure in (10), has the meaning “to club someone/something (once)”. The theme inside (10) has the meaning “to act with a clublike object”, and the satellite inside (10) has the meaning “to strike someone/something once by means of the action denoted by the theme”. If we push our way to the atomic levels, we enter a realm of diffuse semantics. The following are abridgments of semantic descriptions found in Young, Morgan, and Midgette 1982 for the atomic units and category values found in (10):

- (16) root GHAAL: “move in a heavy, undulating, or abrupt manner”
 † classifier: (sometimes) “a causative-transitivizing agent”¹⁰
 momentaneous stem-aspect: “action that takes place at a moment in time”
 YLV conjugation-pattern: (no semantics suggested)
 prefix ná: (unclear in this case)
 prefix d: (unclear in this case)

Upon examining a large number of lexical elements, the following generalizations emerge:

- (17) Cognitive levels associated with the major levels in the Navajo verb lexicon:

<u>verb base</u> :	a fully-specified event or state type
<u>theme</u> :	a general class of action or state
<u>satellite</u> :	variety of semantic types, including specific event-types definable without reference to the action performed to carry them out ¹¹
<u>stem-set</u> :	(none)
<u>root</u> :	a very general notion of an action/state type, or group of these
<u>prefix</u> :	varying

- (18) Cognitive types associated with grammatical/derivational categories of the Navajo verb lexicon:

<u>stem-aspect</u> :	inherent aspect
<u>classifier</u> :	transitivity ¹²
<u>conjugation-pattern</u> :	???

An important and interesting particular case of these generalizations is the following:

- (19) A Navajo theme NEVER denotes an event type.

The fact stated in (19) leads to some surprising results. To examine these, we will need to look at some examples of Navajo satellites. First, here are three satellites which may be thought of as creating relatively simple verbs, by virtue of the fact that these satellites do not contain any prefixes.¹³

- | | | |
|------|------------------------------|---|
| (20) | (a) { } + simple + durative | semantics: "simple event, not further specified" |
| | (b) { } + S + durative | semantics: "event leading to a resulting state" |
| | (c) { } + SLV + semelfactive | semantics: "single instantaneous event" ¹⁴ |

With certain themes that denote very common actions typically engaged in for their own sake, the satellites in (20) can be used to create verb bases that denote events. For example, here are three themes:

- | | | |
|------|---------------|------------------|
| (21) | (a) Ø+ yáá' | action: "ingest" |
| | (b) †+ béézh | action: "boil" |
| | (c) Ø+ ts'óóʔ | action: "suck" |

Combining (20a) with (21a) yields a verb base that means "to eat it"¹⁵; combining (20b) with (21b) yields a verb base that means "to boil it"; and combining (20c) with (21c) yields a verb base that means, somewhat idiomatically, "to give him/her a kiss"¹⁶.

Now, while a moderate number of such simple verb bases exist in the Navajo verb lexicon, the fact is that many event types of the sort denoted by (say) simple Indo-European verbs cannot be expressed in Navajo by means of simple verbs. The reason is that such event types are not defined by virtue of the actions that carry them out, but rather by virtue of some other characteristic of the event. A common example is the notion "give", which is defined by virtue of the change of possession that results from the event. There is no action of

giving¹⁷; to express the “give” notion in Navajo, a special satellite is combined with a theme that represents the real action that is performed. Typically, for “give”, the theme is one of about a dozen themes that describe various kinds of actions of handling something.¹⁸ In fact, these “handling” themes can be used with a considerable number of satellites whose semantics correspond to ordinary verbs in Indo-European languages. Here is a list of a few of those satellites, with their meanings given, and, for fun, a Latin verb theme with approximately the same meaning.¹⁹

(22) <u>Navajo satellite</u> ²⁰	<u>semantics</u>	<u>Latin verb theme</u>
{Paa} + N + momentaneous	“give it to P”	da+Ø
{ná, d} + LV + momentaneous	“pick it up”	toll+e
{ni} + N + momentaneous	“set it down”	po:n+e
{ } + S + neuter	“keep it”	ten+e:, serv+a:
{‘ahii} + FLV + momentaneous	“mix together”	misc+e:
{yisdá} + simple + momentaneous	“rescue him/her”	li:ber+a:
{na} + S + continuative ²¹	“carry around”	fer+Ø, port+a:
{Pidá, d} + N + momentaneous	“cover P with it”	teg+e

There are also Navajo satellites, whose meanings correspond to the meanings of Indo-European verb themes, which are combined with Navajo verb themes other than the ones that denote handling actions. The action themes used with these satellites are partially determined by real-world considerations, partially a lexical matter; working out an analysis of which satellites can be used with which themes is a major study which remains to be done. Here are two examples of such satellites:

(23) <u>Navajo satellite</u>	<u>semantics</u>	<u>Latin verb theme</u>
{Páá, ’, d} + simple + momentaneous	“uncover P”	de:+ teg+e
{dá, ’, d} + N + momentaneous	“close it”	claud+e

The striking thing about the examples in (22) and (23) is that a major typological distinction between Navajo and Latin is revealed: semantic units represented in Latin by head level elements of the verb lexicon are represented in Navajo by non-head level elements. There are no Navajo verb themes that

mean “give”, “pick up”, “cover”, “uncover”, “close”, etc., event types for which there are verb themes in Latin. Moreover, this distinction follows from a general specification of the semantic/cognitive levels which correspond to various lexical levels, shown for Navajo in (17) and (18), and in particular from (19): of course, (19) is untrue for Latin.

7 Conclusions

By examining the Navajo verb lexicon with some care, we have seen that lexical elements exist at a number of different levels, each of which corresponds to a certain type of semantic/cognitive unit. Although we have not carried out a similarly detailed analysis of the Latin verb lexicon here, a cursory examination reveals a major typological difference between the two languages: event-structure units are linked to head levels in the Latin verb lexicon but to non-head levels in the Navajo verb lexicon.

Clearly we have only scratched the surface of lexical structure. Our discussion has begged a number of significant questions, such as the definition of the notion *head* (which we have implicitly relegated to morphological analysis). We have suggested (in the Notes) that the satellite level of the Navajo verb lexicon needs to be further articulated. A proper analysis of the members of the grammatical/derivational categories, especially the stem-aspect category, needs to be carried out. It is to be hoped that further work along the lines begun here may yield deeper insights; in particular, a careful unpacking of the lexicon of individual languages may lead to further typologies.²²

Notes

1 Navajo examples are all given in the orthography which has become current for that language. The standard references (e.g. Young and Morgan 1987, Young, Morgan, and Midgette 1992, or Faltz 1998) may be consulted for an explanation of the characters and diacritics used.

2 The term *mode* has become the usual term designating an inflectional category of the Navajo verb that corresponds roughly to tense/aspect. Imperfective mode corresponds most closely to present tense in discourse isolation, but it can be used with reference to other index times given the appropriate discourse structure, when it indicates roughly time concurrent with the index time.

3 A possible exception to this statement is the process of classifier shift undergone when a verb is used in the passive voice and other similar constructions – see for example Young, Morgan, and Midgette 1992, pp. 879-881, or Faltz 1998, page 313 and Chapter 26. However, such constructions may be best viewed as derivational in Navajo.

4 The terminology for these four sets of Imperfective mode subject prefixes follows Faltz 1998.

5 The eight conjugation-patterns are laid out in Faltz 1998, pp. 384-386, where they are referred to as “conjugation combinations”.

6 To keep things simple in this article, we are ignoring the issue of argument structure. For completeness, there should be a sixth slot in diagrams such as (7) indicating transitivity and linkage with pronominal registrations; in the case of the specific example in (7), we need to at least indicate that the verb in question is transitive, and hence takes object pronoun prefixes.

7 Our conception of themes as presented here is slightly oversimplified. Certain themes have prefixes, so the possibility of prefixes should be shown in the diagrams even when the particular theme involved doesn't have one. Also, transitivity should be indicated for themes. For example, the theme shown inside (9) and (10) should be specified as having no prefixes, and as being transitive. A terminological note: a prefix which is part of a theme is called a *thematic* prefix in the literature.

8 If a theme with prefixes (see Note 7 above) is unified with a satellite with prefixes, the unification will in general result in a verb base whose list of prefixes combines the prefixes from the theme with the prefixes from the satellite; i.e. no conflict will result. However, we will see that a verb base can be created with more than one satellite, which could lead to a conflict of, for example, conjugation-pattern. This is not always fatal, but the description of exactly what happens depends on how certain constructions are analyzed. An interesting case is the seriative construction, which, if regarded as a satellite, can lead to non-fatal conflicts of this sort. See Faltz 1998 Chapter 24 for some examples.

9 In our analysis, no theme contains enough information to determine the forms of any verb. In particular, even if a verb has no derivational prefixes, it still needs a particular stem-aspect and a conjugation-pattern. For this reason, at least one satellite is needed to create a lexical verb. Examples of prefixless satellites are given later in the text. It is also possible to have more than one satellite in the derivational history of a verb. In fact, it is undoubtedly the case that satellites actually constitute more than one lexical level, as can be surmised from the semantics of satellites (see Note 11).

10 In some cases, the transitivity of a theme can be directly linked to the classifier; this is particularly true in the case of distinct themes that use the same root but differ in transitivity. For example, there are many pairs of themes in which a theme using the † classifier is the transitive partner of an intransitive theme using the same root but the ∅ classifier. But there are other cases where the classifier choice has nothing to do with transitivity; the same root with different classifiers simply have different (usually very distantly related) semantics. In such cases we say that the classifier is *thematic*.

11 The semantic areas covered by satellites include a rich variety of domains, such as aspect-creating operators like “begin”, “end”, and “finish”, path-defining information of the sort used with motion verbs, notions like “more” and “back”, etc. It is probably the case that there are distinct lexical levels of satellites carrying distinct semantic domains; a careful combinatorial analysis will be needed to sort this issue out.

It will not have escaped the reader's attention that notions such as the ones indicated for Navajo satellites are often represented in Indo-European languages by verb-particles and/or affixes. However, Navajo satellites cover a far larger range of semantics. Read on.

12 Not all classifier occurrences can be linked to transitivity. See note 10.

13 To save space, each satellite in (20) is shown as a horizontal diagram of three items separated by plus signs. The first element is a list of the prefixes of the satellite, inside

curly brackets: { }; if the satellite has no prefixes, these brackets are simply filled with nothing. The second element is the conjugation-pattern. The third element is the stem-aspect.

In (21), themes are similarly represented as a diagram of two items separated by a plus sign. The first is the classifier, and the second is the root.

14 Verb bases created by (20a) and (20b) tend to fall into the category of accomplishments, using the familiar analysis of Vendler 1967, unless overruled by additional semantic operators. Similarly, verb bases created by (20c) fall into the category of achievements. There doesn't seem to be a prefixless satellite specifically used for creating verb bases that denote actions (in Vendler's sense); however the satellite {na} + S + continuative is frequently found with just this semantic effect. Note that this satellite, combined with a "handling" theme, yields words meaning "carry around" (see (22)).

15 The theme in (21a) is relatively nonspecific as to the action employed in order to ingest something. The verb created by combining (21a) with (20a) is freely used to indicate ordinary eating. However, there are other themes that refer to specific actions involved in ingestion, such as the action of chewing a hard object, the action of chewing a flat object, the action of eating a plurality of objects, etc. The satellite in (20a) can be used with these themes to form verbs that denote eating by means of the indicated action.

16 Of course, idioms can always be expected when dealing with derivational processes. Another example of an idiom: combining the satellite in (20a) with the theme inside of (10) yields a verb base meaning "to beat it (a drum)" and also "to shell it (corn)".

17 Is the absence of a "giving" action (from the Navajo theme lexicon) a fact about the Navajo language, or is it a fact about cognition? Arguably, verbs whose meaning is "give", such as English *give*, do not specify any action type; in other words, it is not out of the question that we are dealing with a cognitive fact here.

18 It is probably the case that the various "handling" themes differ amongst themselves in that they denote different actions, rather than, as is usually stated, that they classify the kind of object which is handled. Handling a compact rigid solid object, or a liquid, or a rope, or a blanket, all involve different actions. Since certain actions are typical for handling certain kinds of objects, it is generally the case that the kind of object involved determines which handling theme is used in any expression involving handling an object of that kind.

19 We have not presented an analysis of the Latin verb lexicon here. However, it is clear that there is a root level in this lexicon, and that themes are created by combining the root with a suffix, which is occasionally zero but most often is one of four vowels. The Latin examples are shown as a root followed by its suffix, separated by a plus sign. In one case in (23), a prefix is indicated as well.

20 Some of the prefixes in the satellites in (22) and (23) have the symbol "P" in them. This symbol stands for a pronominal prefix. Using a satellite with such a prefix adds to the argument structure of the verb bases formed with that satellite. The listing under "semantics" represents in an informal way how the referent of this pronoun enters into the semantics of the resulting combination.

21 This satellite can be used with a significant number of action themes to create verb bases whose meaning is "to engage in the action specified by the theme", i.e. verb bases whose events have no additional event-structure apart from the performance of the action. Such events are "actions" in the sense of Vendler 1967, as mentioned in Note 14.

22 The reader will find it extremely instructive to compare the comments in this article with the very careful analysis found in Talmy 1975, which deals with motion events in Atsugewi, a Hokan language not related (or at least, not known to be related) to Navajo but whose verb lexicon appears to resemble the Navajo lexicon in a significant number of ways. One conclusion of the discussion here is that Talmy's style of analysis can, or should, be carried out globally throughout the lexicon. Incidentally, I appear to have picked up the term "satellite" from Talmy's work.

References

- Faltz, Leonard M. 1998. *The Navajo Verb*. Albuquerque: University of New Mexico Press.
- Greenough, J.B., G. L. Kittredge, A. A. Howard, and Benj. L. D'Ooge. 1975. *Allen and Greenough's New Latin Grammar*. New York: Caratzas Brothers.
- Shieber, Stuart M. 1986. *An Introduction to Unification-Based Approaches to Grammar*. Stanford: Center for the Study of Language and Information.
- Talmy, Leonard. 1975. "Semantics and Syntax of Motion", *Syntax and Semantics*, 4:181-238.
- Traupman, John C. 1995. *The New College Latin and English Dictionary*. Revised and Enlarged New York: Bantam.
- Vendler, Zeno. 1967. *Linguistics in Philosophy*. Ithaca: Cornell University Press.
- Young, Robert W. and William Morgan, Sr. 1987. *The Navajo Language*. 2nd ed. Albuquerque: University of New Mexico Press.
- Young, Robert W., William Morgan, Sr., and Sally Midgette. 1992. *Analytical Lexicon of Navajo*. Albuquerque: University of New Mexico Press.

Leonard M. Faltz
Arizona State University
Department of Computer Science and Engineering
Tempe, AZ 85287-5406
faltz@asu.edu

On the Parallelism between Possessor Extraction and Subject Extraction

Lena Gavruseva
University of Iowa

1. Introduction

This paper examines the syntax of wh-possessive noun phrases in a variety of languages to determine what syntactic constraints are involved in allowing extraction of wh-possessor phrases in some languages, while disallowing it in others. The data subject to an analysis are drawn from the Germanic languages (English and German) as well as from Hungarian, Tzotzil, and Chamorro. The Germanic languages represent a grammar type which prohibits extraction of wh-possessor DPs out of a larger DP, as illustrated in (1-2):

English:

- (1) a. Whose car did John break?
b. *Whose_i did John break [_{DP} t_i car]?
c. *Who_i did John break [_{DP} t_i 's car]?

German (from Corver 1990):

- (2) a. [Wem seinen Wagen]_k hast du [_{DP} t_k] gesehen?
Who-DAT his-ACC car-NOM have you seen
'Whose car have you seen?'
b. *Wem_k hast du [_{DP} t_k seinen Wagen] gesehen?
Who-DAT have you his-ACC car-NOM seen

By contrast, languages like Hungarian, Chamorro, and Tzotzil fall into a grammar type that allows wh-possessor-DPs to optionally extract out of the DP, as illustrated in (3-5):

Hungarian (from Szabolcsi 1983:84):

- (3) Ki-nek_k ismer-té-tek [DP t_k a vendég-é-ø-t]]?
Who-Dat know-past.2pl the guest-poss.3sg.Acc
'Whose guest did you know?'

Chamorro (from Chung 1991)

- (4) Hayik un-yuland [DP munika-ña tk]?
 Who Infl(2c)-break doll-Agr(3sg)
 'Whose doll did you break?'

Tzotzil (from Aissen 1996)

- (5) Buch`uk av-il-be [DP s-tot tk]?
 Who 2sg-see-IO 3sg-father
 'Whose father did you see?'

In the languages in (1-5), possessive noun phrases are analyzed as DPs, with wh-possessor-DPs occupying the Spec of DP. The data above are also similar in that possessor extraction takes place from the object position, in the configuration as in (6):

- (6) [V [_{DP} t D ...]] (word order irrelevant)

The representation in (6) shows that the trace of a wh-extracted possessor is within the governing domain of a [+V] lexical head. Therefore, the differences in extraction patterns between (1-2) and (3-5) cannot be unquestionably attributed to the failure of external constraints (e.g. the ECP) to license the wh-trace in Spec.DP. Technically speaking, the outside [+V] governor should be able to license the trace of wh-possessors in object extraction questions.

Thus, the contrasts between (1-2) and (3-5) suggest that external constraints alone cannot be involved in allowing extraction of DP-specifiers and some other syntactic properties of possessive noun phrases are likely to give rise to the crosslinguistic variation. This paper will argue that the parametric variation in (1-5) can be pared down to one property of possessive noun phrases, namely the availability of a peripheral A-bar position in the DP. Building on the work of Szabolcsi (1983/84, 1994), Giorgi & Longobardi (1991), I will argue that possessor extraction is possible in a language *L* only if possessor-DPs extract via successive-cyclic movement. The intermediate step of the successive-cyclic operation is a DP-internal possessor movement to an A-bar position, the Spec of DP.

2. Theoretical background

Some of the earlier approaches to extraction out of NP attempted to reduce the parametric variation to general constraints or single syntactic conditions such as the Left-Branch Condition (Ross 1967/81), Empty Category Principle (Chomsky 1986, Corver 1990, Mahajan 1992, Rizzi 1990, Stowell 1989),

Subjacency (Bowers 1988, Diesing 1992), a Condition on Extraction Domain (Huang 1982), or the Specificity Condition (Chomsky 1973, Fiengo & Higginbotham 1981). Furthermore, some of these researchers suggest that certain interpretive aspects of noun phrases (for example, specificity, presuppositionality, referentiality) interact with the ECP or Subjacency in determining extraction possibilities out of NP (Diesing 1992, Mahajan 1992, Stowell 1989).

In the spirit of this line of work, the data from Germanic in (1-2) could be explained if the specificity of the possessive DP somehow made it impossible to license the wh-trace in the Spec,DP. Mahajan (1992) suggests that specific object DPs move to the Spec of ArgOP to check their case. In Mahajan's framework, Spec,AgrOP is an ungoverned position, therefore wh-extraction from it violates the ECP. Mahajan notes (in footnote 7), however, that the specificity effects do not hold in V-final languages (e.g. Hindi, Hungarian). Indeed, notice that the wh-possessor *ki-nek* in (3) is extracted from the specific DP headed by the overt determiner *a(z)* ('the'). We will see below in (3.2) that Mahajan's proposal cannot be extended to the data from Italian where prepositional possessor phrases are allowed to extract from the specific DP projected from the overt definite determiner. Possessor extraction is possible out of specific DPs in Italian, even though Italian is analyzed as an SVO language.

Other researchers argue that extraction out of NP is determined by the DP/NP distinction in the syntactic status of noun phrases and the Subjacency or ECP (Bowers 1988, Corver 1990). Corver, in particular, addresses the issue of parametric variation in possessor extraction between the Germanic and Slavic languages and proposes that the differences follow from the interaction of the ECP, the status of noun phrases as DPs or NPs, and Case.¹ Specifically, Corver stipulates that Case can block antecedent-government of the wh-trace in the spec position if it is assigned to a DP argument. By contrast, Case has no blocking effects if it is assigned to a noun phrase that projects only to NP. Thus, in Cover's framework, the impossibility of possessor extraction in Germanic follows from the analysis of noun phrases as DPs and the possibility of extraction in Slavic follows from the analysis of noun phrases as 'bare' NPs.

It is important to point out that the data in (3-5) cannot be accommodated within Corver's parametric theory of possessor extraction. Just like in Germanic, possessive noun phrases in Hungarian, Chamorro, and Tzotzil are analyzed as DPs (Szabolcsi 1994, Chung 1991, Aissen 1996). Furthermore, possessors are extracted from the case-marked DPs (notice, for instance, the Accusative case marker *-t* on the possessed noun 'guest' in Hungarian). However, contrary to the predictions of Corver's theory, the DPs in these languages are not rendered barriers for wh-extraction. This suggests that the analysis of noun phrases as DPs *per se* is not a predictor in and of itself of what extraction options are permitted in a language L. In this connection, the relevant question is what properties of possessive noun phrases analyzed as DPs predict possessor extraction and what properties predict a lack of thereof. I will address this question in (4.) after giving a brief overview of the work of

Szabolcsi (1983/84, 1994) and of Giorgi & Longobardi (1991) that provides a foundation for my account.

3. Origins of the proposal

An account of parametric differences in possessor extraction that I develop in this paper is largely inspired by the work of Szabolcsi (1983/84, 1994) and Giorgi & Longobardi (1991) (henceforth G&L) on the structure of possessive noun phrases in Hungarian and in Romance respectively. First, I will present Szabolcsi's analysis of Hungarian possessives, to which I will refer as *the DP=CP Hypothesis*. Next, I will sketch out G&L's analysis of possessor extraction in Italian, to which I will refer, following Godard (1992), as *the Specifier Hypothesis*.

3.1 The DP=CP hypothesis (Szabolcsi 1983/84, 1994)

Szabolcsi assimilates the syntax of possessor extraction in Hungarian to the syntax of subject extraction in languages like English. An important contrast that Szabolcsi considers is the difference in extraction possibilities between the possessive constructions with Nominative possessors and those with Dative possessors. As shown in (7), only the Dative-marked possessor-DPs can extract in Hungarian:

- (7) a. *Mari_k fekete volt [_{DP} a t_k kalap-ja].
 Mari-Nom black was the hat-poss.3sg.NOM
 'Mary's hat was black.'
- b. Mari-nak_k fekete volt [_{DP} t'_k a t_k kalap-ja]
 Mari-Dat black was the hat-poss.3sg.Nom
 'Mary's hat was black.'

Szabolcsi accounts for the contrasts in (7) by proposing that possessor-DPs can extract only if they first move to the peripheral specifier position of the functional head D projected from the definite determiner *a(z)* ('the'). The representation in (8) captures the steps of possessor extraction in Hungarian:²

- (8) Mari-nak_k...[_{DP} t_k'' [_D a [_{AgrP} t_k' [_{Agr} (+poss) [_{NP} t_k kalap-ja]]]]]

In (8), the possessor originates in the spec of the possessed noun, then moves to the Spec.AgrP and from there moves to the Spec,DP. Possessor extraction to the scope position, a Spec of CP, takes place from Spec,DP. Szabolcsi claims that the step of possessor movement to Spec,DP is facilitated by the need to turn the functional head D into a proper governor for the trace in the Spec of AgrP.

By assumption, D is inert for government unless it is rendered an active governor through Spec-Head agreement with a DP argument in its specifier. The impossibility of extracting Nominative possessor-DPs that sit in the Spec of AgrP receives a straightforward explanation: an inert D is unable to govern the trace in the Spec.AgrP and by minimality prevents a lexical [+V] governor from licensing it from the outside.

Since possessor movement to the Spec,DP is a required step that precedes subsequent extraction out of DP, Szabolcsi suggests that possessor extraction is akin to subject extraction in English which also obligatorily proceeds through the peripheral position, the Spec of CP. Hence, the DP=CP parallel. For comparison, I show the steps of subject extraction in English in (9):

(9) [_{CP} Who_k do you think [_{CP} t_k'' [_C \emptyset [_{IP} t_k' [_I [_{VP} t_k [_V came]]]]]]]]]?

3.2 The Specifier hypothesis (Giorgi & Longobardi 1991)

Giorgi & Longobardi's analysis of possessor extraction in Italian draws on the work of Cinque (1980) who noted that (a) only arguments of the form *di NP* ('of NP') can be extracted out of NP and (b) that extractable *di NP* constituents are interpreted as subjects of the head noun. To illustrate Cinque's point known as *Ginque's generalization*, consider the examples in (10):

Italian:

- (10) a. il desiderio [_{PP} di Gianni]
the desire of Gianni
b. la descrizione [_{PP} di Gianni]
the description of Gianni

The Prepositional Phrase *di Gianni* in (10a) is ambiguous between the interpretation as the theme of the desire and the experiencer of it. Likewise, the reading of *di Gianni* in (10b) is ambiguous between the theme of the description and the agent of it. Cinque refers to the interpretation of *di Gianni* as experiencer or agent as a subject reading and notes that this reading would obtain if *di Gianni* functioned as a subject of the verbs 'to desire' and 'to describe'.

The subject reading of a *di NP* phrase is preserved when it is replaced with a possessive pronoun or when it undergoes wh-extraction. In (11), *di Gianni* is replaced with a possessive pronoun that can be interpreted only as the subject of the 'desire' and the 'description':

- (11) a. il suo desiderio
the his desire
'his desire'

- b. la sua descrizione
 the his description
 ‘his description’

Similarly, the examples in (12) below illustrate that a wh-extracted *di Gianni* receives a subject reading:

- (12) Gianni. [di cui]_k abbiamo ricordato [il desiderio t_k]
 Gianni. of whom (we) remembered the desire
 ‘Gianni. whose desire we remembered.’

In (12), a wh-extracted PP appears as a relative pronoun *di cui* (‘of whom’) associated with *Gianni* and interpreted as the subject of the desire. Hence, Cinque’s proposal that only *di NPs* that are interpreted as subjects can be extracted out of NP in Italian.

G&L take a closer look at the internal structure of nominals in Italian and propose that *di NP* arguments with a subject reading occupy a structural subject position in the NP. They suggest, further, that extraction of *di NPs* takes place through the Spec of NP. Just like Szabolcsi, G&L motivate this movement step by the necessity to turn the head noun into a proper governor for the trace in the base subject position.³ Consider the representation in (13):

- (13) di cui_k..... [il [_{NP} t_k [_N [_N desiderio] t_k]]]]

As shown in (13), the *di NP* possessors cannot be extracted in one fell swoop and are required to move through the intermediate position within the NP, namely the Spec of N. By extension, G&L argue that *di NPs* with a theme reading are base-generated as complements of the noun head and suggest that N-complements cannot move to the Spec of NP (presumably, N-complements cannot trigger Spec-Head agreement with N).

3.2.1 Further extensions of G&L’s analysis

Having presented G&L’s analysis of extraction out of the NP, let me now point out and comment on an interesting asymmetry in extraction possibilities between the *di NP* possessors and possessive pronouns (G&L do not discuss this asymmetry). G&L argue that possessive pronouns occupy the Spec,NP position in the constructions as in (11) above. However, unlike the *di NP* possessors, possessive pronouns may not be extracted from the Spec of NP, as shown in (14):

- (14) *Suo_k ha visto [il [_{NP} t_k [_N libro]]].
 His (he) has seen the book.
 ‘He saw his book.’

I suggest that the impossibility of extracting *suo* in (14) can be explained if we assume that possessors in Italian are required to extract not only through the Spec of NP but also through the Spec of DP. The head of the latter position is the definite determiner. The representation in (15) shows the steps of possessor extraction in Italian on the DP analysis of noun phrases:

- (15) di cui_k... [DP t_k' [D il [NP t_k' libro t_k]]]
 of whom the book

Suppose that only arguments of NP may move to the Spec of DP, as suggested in Avrutin (1994) who follows Pesetsky (p.c). Then the impossibility of extracting *suo* is explained: since possessive pronouns in Italian are analyzed as adjectival modifiers (G&L 1991), they may not extract via the Spec of DP.

3.3 Summary

In discussing the work of Szabolcsi and G&L, I showed that possessor phrases in Hungarian and Italian do not extract directly from their base-position (Spec of NP), but rather extract successive-cyclically through a peripheral specifier position, Spec of DP. In the framework of these researchers, possessor movement to the Spec,DP is motivated by the ECP, namely by the necessity to turn the projecting heads N and D into proper governors. Thus, while being superficially dissimilar (postnominal PPs in Italian and prenominal DPs in Hungarian), possessor phrases in both languages follow the same extraction path within the DP. In what follows, I will argue that the parametric variation illustrated in (1-5) can be reduced to the availability of a successive-cyclic movement option for the wh-possessors in a language L.

4. Proposal of the paper

In this section, I aim to provide an answer to the following question: Why is a successive-cyclic movement option available for wh-possessors in languages like Hungarian, Tzotzil, Chamorro, and Italian but not in the Germanic languages?⁴ I begin exploring an answer to this question with an observation that some languages that allow extraction exhibit the so-called “possessor” agreement. Consider the wh-possessive noun phrases in (16):

- (16) a. Ki-nek a vendég-é-ø (Hungarian)
 Who-Dat the guest-poss.3sg.Nom
 ‘Whose guest?’
 b. Hayi munika-ña (Chamorro)
 Who doll-3sg
 ‘Whose doll?’

- c. Buch`u s-tot (Tzotzil)
 Who 3sg.father
 'Whose father?'

The data in (16) show that wh-possessor DPs trigger "possessor" agreement in person and number features with the possessed noun. This agreement is expressed by means of an affix on the possessed N. Interestingly, the same affix indicates clausal subject-predicate agreement in all three languages. Another property that the wh-possessives in (16) share is that wh-possessors are not overtly marked for case. Hungarian may seem to be an exception, since the wh-possessor *ki-nek* is glossed as being marked for dative Case. However, Szabolcsi (1994) casts doubt on interpreting the morpheme *-nek* as a case-marker. She points out that the *-nak/nek* morpheme "serves a variety of other un-case-like purposes, such as marking modifiers in left dislocation and in complex predicate constructions" (p.203). Given Szabolcsi's observations, the suffix *-nek* on the wh-possessor *ki* may simply indicate that it is a dislocated constituent as opposed to a constituent marked for dative Case. Thus, on this alternative interpretation of the *-nak/nek* morpheme, the Hungarian wh-possessive data are compatible with the data from Tzotzil and Chamorro.

By contrast, English wh-possessors are overtly marked for Genitive case and there is no overt "possessor" agreement between the wh-possessor and the possessed noun, as shown in (17):

- (17) Who's dream? (who's =whose)

Similarly, there is no Hungarian-type "possessor" agreement in German. In German, possessors appear in genitive Case and in some dialects (e.g. the Bavarian dialect) in dative Case. The possessive constructions with Dative possessors are interesting from the point of view of agreement relations in the DP. As shown in (18-19), instead of agreeing with the possessed NP, the possessor agrees in gender with the D head realized as the possessive pronoun:

- (18) a. Dem Jungen sein Vater
 the(Dat) boy his (Nom.sg.masc.) father
 'the boy's father'
 b. Dem Jungen seine Mutter
 the(Dat) boy his (Nom.sg.fem.) mother
 'the boy's mother'
 c. Dem Jungen seine Autos
 the(Dat) boy his (Nom.pl.) cars
 'the boy's cars'
- (19) a. der Mutter ihr Vater
 the(Dat) mother her (Nom.sg.masc.) father
 'the mother's father'

- b. der Mutter ihre Katze
 the(Dat) mother her (Nom.sg.fam.) cat
 'the mother's cat'
- c. der Mutter ihre Autos
 the(Dat) mother her (Nom.pl.) cars
 'the mother's cars'

The data in (18-19) also show that the possessive pronoun agrees in number and gender with the possessed NP. Thus, there is a two-way agreement in Dative possessive constructions in German (Possessor--D head and D head--possessed NP).

I will first focus on the contrast in case-marking of wh-possessors between the Hungarian-type languages and the Germanic languages. Following some recent analyses of NPs and approaches to structural case (Abney 1987, Chomsky 1995, Stowell 1989), I assume that possessor-DPs check their structural case via Spec-Head agreement with a functional head D in both types of languages. In English, wh-possessors and D bear a [-interpretable] genitive case feature; the case-checking operation has an overt morphological spell-out in the form of the clitic 's. Similarly, in German, wh-possessors and D can bear either a [-interpretable] genitive case feature or a [-interpretable] dative case feature. The former is spelled-out as the genitive 's (genitive wh-possessors do not bear 's but rather are considered to be frozen forms) and the latter is overtly seen on the form of the definite determiner (*dem*). Since wh-possessors in English and German check their case in the Spec of DP, this position is recognized as an A-position in the two languages. I proposed earlier that wh-possessors can be extracted in a language L only if they first move to an A-bar position inside the DP. The case-marking properties of the wh-possessives in Germanic suggest that wh-possessors move to an A-position, therefore possessor extraction cannot take place from the Spec of DP.

Turning to the Hungarian-type languages, I propose, following Szabolcsi (1994), that the absence of overt case morphology on the possessor-DPs suggests that possessor phrases in these languages bear nominative Case (nominative Case has no overt affix in all three languages), which they check against the attracting head D that also bears the same [-interpretable] case feature. While the Spec of DP where possessors receive structural nominative Case counts as an A-position, it is plausible to assume that the structure of wh-possessives in the Hungarian-type languages also makes available another Spec of D that is an A-bar position. The higher Spec of D serves as an escape hatch for wh-extracted Nominative wh-possessors.

5. Conclusion

In this crosslinguistic investigation of possessor extraction, I argued that possessor extraction is a subcase of successive-cyclic A-bar movement. Building on the work of Szabolcsi (1983/84, 1994) and Giorgi & Longobardi (1991), I suggested that the differences in possessor extraction possibilities between the Germanic languages and Hungarian-type languages can be reduced to the availability of an escape hatch A-bar position (Spec,DP) within the wh-possessive DP. With respect to the Germanic languages, I argued that there is no A-bar position in the internal structure of wh-possessives. By contrast, the wh-possessives in the Hungarian-type languages avail themselves of such a position. I also noted that the availability of a DP-internal A-bar position in a language L correlates with the presence of overt "possessor" agreement in the DP and the morphologically invisible nominative case on wh-possessor-DPs.

6. Endnotes

¹ Corver (1990) defines the ECP as antecedent-government, following Chomsky (1986).

² I follow Szabolcsi (1983/84) in assuming that the internal structure of possessive noun phrases in Hungarian contains two functional projections, AgrP and DP.

³ Giorgi & Longobardi's analyses of noun phrases is executed in a pre-DP framework. G&L suggest that the subject position of *di NP* phrases is the right branch sister of the N-bar. The possibility of generating external arguments of the NP (e.g. possessors) on the right edge of the N-bar is taken to be a point of crosslinguistic variation between the Romance and Germanic languages.

⁴ Incidentally, German is not a uniformly [-possessor extraction] language. It is only Dative and Genitive wh-possessor-DPs that cannot extract. Extraction of postnominal possessors of the form *von NP* ('of NP') is optionally allowed. In this way, extraction of *von NP* possessors in German parallels extraction of *di NP* possessors in Italian. Notice that in view of this parallelism, G&L's claim that the possibility of projecting a spec position to the right of the N-bar is a point of crosslinguistic variation between Germanic and Romance does not hold water. The discussion of extraction of German possessor-PPs is beyond the scope of this paper.

7. References

- Abney, Steven Paul. 1987. *The English noun phrase in its sentential aspect*. Ph.D. dissertation, MIT.
- Aissen, Judith. 1996. "Pied-piping, abstract agreement, and functional projections in Tzotzil". *Natural Language and Linguistic Theory*. 14: 447-491.
- Avrutin, Sergey. 1994. "The structural position of bound variables in Russian". *Linguistic Inquiry*, 25.4:709-727.

-
- Bowers, J. 1988. "Extended X-bar Theory, the ECP, and the Left Branch Condition". In *Proceedings of the West Coast Conference on Formal Linguistics*.7: 47-62. Stanford Linguistics Association. Stanford University.
- Cinque, Guglielmo. 1980. "On extraction from NP in Italian", *Journal of Italian Linguistics*. 1.2:47-99.
- Chomsky, Noam. 1973. "Conditions on Transformations", In Steven Anderson and Paul Kiparsky (eds.), *A Festschrift for Morris Halle*. NY: Holt, Rinehart & Winston.
- Chomsky, Noam. 1986. *Barriers*. Cambridge, MA: MIT Press.
- Chomsky, Noam. 1995. *A Minimalist program for linguistic theory*. Cambridge, MA: MIT Press.
- Chung, Sandra. 1991. "Functional heads and proper government in Chamorro", *Lingua*. 85:85-134.
- Corver, Norbert. 1990. *The syntax of left branch extractions*. Ph.D. dissertation. Tilbur University.
- Diesing, Molly. 1992. *Indefinites*. Cambridge, MA: MIT Press.
- Fiengo, R. and J. Higginbotham. 1981. "Opacity in NP". *Linguistic Analysis*. 7:395-421.
- Gavruseva, Lena. 1997. The syntax of possessive phrases and acquisition of whose-questions: A comparative study of child L1 and L2 grammars. Ph.D. dissertation.. Georgetown, University.
- Giorgi, Alessandra and Giuseppe Longobardi. 1991. *The syntax of noun phrases: Configurations, parameters, and empty categories*. New York: Cambridge University Press.
- Godard, Daniele. 1992. "Extraction out of NP in French". *Natural Language and Linguistic Theory*. 10: 233-277.
- Huang, C.-T. James. 1982. *Logical relations in Chinese and the theory of grammar*. Ph.D. dissertation. MIT.
- Mahajan, Anoop. 1992. "The specificity condition and the CED". *Linguistic Inquiry*. 23.3:510-515.
- Rizzi, Luigi. 1990. *Relativized minimality*. Cambridge, MA: MIT Press.
- Ross, John Robert. 1967/1986. *Infinite syntax!*. Norwood, NJ: Ablex.
- Stowell, Tim. 1989. "Subjects, Specifiers, and X-Bar Theory". In Mark R. Baltin and Anthony S. Kroch (eds.), *Alternative conceptions of phrase structure*. Chicago: The University of Chicago Press.
- Szabolcsi, Anna (1983/84). "The possessor that ran away from home". *The Linguistic Review*. 3: 89-102.
- Szabolcsi, Anna. 1994. "The noun phrase", In Ference Kiefer & Katalin Kiss (eds.), *Syntax and Semantics*. 27:179-274.

Lena Gavruseva
Linguistics Department
EPB 551
University of Iowa
Iowa City, IA 52242
elena-gavruseva@uiowa.edu

Discourse Restrictions on Multiple Wh and Syntactic Implications*

Kleanthes K. Grohmann

University of Maryland, College Park

1 Multiple Wh and Domain-Driven Syntax

The subject of this study will be multiple interrogatives, in particular questions with two Wh-elements (henceforth, "Multiple Wh"), and the contrast between English and German exemplified in (1-2):^{1,2}

- | | |
|----------------------------|------------------------------------|
| (1) a. Who kissed whom? | (2) a. When did who kiss Maria? |
| b. *Whom did who kiss? | b. *How did you kiss Maria why? |
| (3) a. Wer hat wen geküßt? | (4) a. Wann hat wer Maria geküßt? |
| b. Wen hat wer geküßt? | b. Wie hast du Maria warum geküßt? |

On a descriptive level, the Superiority Condition (Chomsky 1973) supposedly accounts for possible Multiple Wh: fronting of the lower Wh is blocked and thus prohibited by an intervening, superior Wh.³ There are a number of purely syntactic accounts in the literature, most of which have failed to capture not only variance or even exceptions among different types of Multiple Wh in English (such as (2a)) but also among dialects and other languages (cf. (3-4)).⁴

In this paper, I will investigate the possibility of discourse factors being involved in the contrast (1-4) above and many others. On a theoretical level, I will propose an analysis to the syntax of Multiple Wh in German (and to some extent, English) within the minimalist framework (Chomsky 1995). The core of the syntactic analysis, however, is of pragmatic nature: I will show that Multiple Wh-constructions in German underlie a strict discourse requirement which I will label "Discourse-Restricted Quantification" (DRQ).

Superiority violations in the Minimalist Program can basically be conceived of as a violation of some version of the Shortest Move/Minimal Link Condition (see Chomsky 1995, for example): an element may not be fronted over a closer element of the same type; either cross-linguistic variation (now more unlikely) or other (possibly syntactic) processes must then be involved.⁵

The interaction of Wh-movement and other movement operations has been considered in recent years. In particular, many researchers argued in favour of linking Wh-movement to previously applying (A-)movement operations (such as Boskovic 1997, Hornstein 1995, Takahashi 1993 among others).

In Grohmann 1997a, I apply the scrambling-approach to German, where some types of scrambling involve A-movement. However, I take German word order particulars to remain mysterious in general; I hence follow the following dichotomy: re-ordering below the subject is the result of A-movement, while fronting arguments over the subject invokes the C-domain as instances of topicalization (Grohmann 1996, 1997b, in progress).⁶

Without going into detail for reasons of space and exposition, let us simply assume the following (Grohmann, in progress). Clause structure consists of three prolific domains, i.e. configurational areas with specified syntactic content and semantic relations: VP where thematic relations are established, TP where agreement relations are established and CP where information relations are established. Arguments in German may not survive inside the thematic domain at the interfaces but must have established agreement relations: hence movement to FP (which might stand for “AgrOP,” yet leaving out specific checking relations for the time being). The subject canonically raises to SpecTP—at least for reasons of EPP.

It is irrelevant for the present purposes whether direct and indirect object are generated in either order or whether the surface order is purely derived by movement. Let us for the sake of exposition assume two possible representations for standard, subject-initial matrix clauses in German such as in (5):

- (5) a. [_{TP} Martin_i hat [_{FP} Maria_j [_{FP} das Buch_k [_{VP} t_i gegeben t_j t_k]]]]
 b. [_{TP} Martin_i hat [_{FP} das Buch_i [_{FP} Maria_k [_{VP} t_i gegeben t_j t_k]]]]
 ‘Martin gave the book to Maria.’

On the other hand, movement into the C-domain involves at least a number of Top(ic)P’s—adopting to some degree Rizzi’s (1997) work on the left periphery. Instances of left-peripheral movement will be presented throughout this paper; so let us for now assume something like (6) for German clause structure:

- (6) [_{infc} CP—TopP*—FocP—TopP*]—[_{agr} TP—FP*—...]—[_{theta} VP]⁸

Of course, just as movement over the subject of a non-interrogative object is an instance of information-driven topicalization, one might account for German Multiple Wh in terms of this leftwards movement.

More general: if there is “independently motivated” movement prior to Wh-checking, could Multiple Wh involve topicalization? This would imply that the lower Wh in (3), for example, is not *in situ* as standardly assumed but has also moved to the left periphery. (7) shows, however, that German is not a language that fronts its Wh-elements in the same way that Bulgarian, for instance, does.⁹

- (7)* Wer wen hat geküßt?

I will present this independent motivation for movement of Wh-elements that suggests a view of “Wh-topics” in German Multiple Wh.

2 Discourse-Restricted Quantification

Pesetsky (1987) started a by now rich history in treatment of apparent Superiority violations in English, as exemplified in (8):

- (8) a. Which student kissed which professor?
 b. Which professor did which student kiss?

We can see that certain Wh-phrases may be fronted in either order,¹⁰ what makes the Wh-phrases in (8) different from those in (1), for example, is their complexity. Pesetsky showed that these Wh-phrases are D(iscourse)-linked, i.e. they bear inherently referential properties that allow a derivation different from wide-scoping, non-referential bare Wh-elements.

The case of D-linked Wh-phrases extends naturally to even more complex Wh-phrases, such as (9):¹¹

- (9) a. Mary asked which of the students kissed which of the professors.
 b. Mary asked which of the professors which of the students kissed.

With D-linking in mind, let us now turn to an approach to the apparent Superiority violations in German Multiple Wh. To start with, consider the two situations depicted in (10) and (11):

(10) Situation I: *A professor talks at the faculty meeting about recent events.*

“I know that Al, Bob and Claire kissed—and I don’t mean each other.”

- a. Who kissed whom?
 b. * Whom did who kiss?
 c. # Wer hat wen geküßt?
 d. # Wen hat wer geküßt?

(11) Situation II: *Another professor provides more information.*

“I know that Al, Bob and Claire kissed Xavier, Yvonne and Zed.”

- a. Who kissed whom?
 b. * Whom did who kiss?
 c. Wer hat wen geküßt?
 d. Wen hat wer geküßt?

As the contrast in the two situations shows, there seems to be a restriction on the well-formedness of Multiple Wh in German which does not seem to apply in English; in particular, Multiple Wh in German are only felicitous if possible referent sets of both Wh-elements have been introduced into the discourse—in sharp contrast to English.¹²

This contextual requirement on Multiple Wh in German, I capture with the felicity condition which I call “Discourse-Restricted Quantification” as shown in (12): let us assume for the time being that DRQ is operative (strictly) in German but not (at all) in English (adopted from Grohmann 1998).

(12) *Discourse-Restricted Quantification*

Questions involving two Wh-expressions are felicitous iff the referent sets of both Wh are determined by the context; such determination is satisfied by providing a list of more than one possible referent in the discourse.

One might wonder whether this discourse restriction (ultimately, pragmatics) could possibly correlate to grammatical derivations (syntax). I will argue in the next section that we have both in German: special pragmatic circumstances and special syntactic properties. I suggest to relate the two by overtly moving both Wh-elements to the left periphery, a fronting strategy that I will refer to as “topicalization” (in the general sense). In this respect, Multiple Wh in German contain two “Wh-Topics,” both in the left periphery (an articulated C-domain).

3 Support for Multiple Wh-Topicalization

The proposal is then that if the discourse forces the referent sets of both Wh-elements to have been introduced in German (but not in English), it should mark it syntactically; one way of doing so is viz. topicalization: both Wh-elements move overtly to TopP to check this discourse property [Top].¹³

Preliminary support for the details of the analysis comes from Multiple Wh in English involving partitive Wh-phrases:

- (13) a. * Which professor did who kiss?
 b. Which of these professors did who kiss?

The difference observed in (13) is that many speakers accept fronting of a “lower” partitive Wh-phrase over a “higher” bare Wh but not fronting of a mere D-linked Wh.

Partitivity—whatever its exact syntactic structure—is suggested to be involved which I take to denote the locus of [Top] on the Wh-element. The contrast in (13) suggests that English marks special properties (i.e. [Top]) only on explicit Wh-elements, while German does so on all Wh-elements:¹⁴ we could say that German Wh-expressions have a deeper, abstract structure, namely that of partitives. A suggestion of this idea is illustrated in (14-15):

- (14) a. [_{DP} welchen [+Wh] von [_{DP} diesen [+Top] Professoren]]
 b. [_{DP} wen [+Wh] [_{DP} [+Top]]]
 (15) a. [_{DP} which [+Wh] of [_{DP} these [+Top] professors]]
 b. [_{DP} who [+Wh]]

Further evidence in favour of the existence of Wh-topics in the grammar is presented by Wu (1996): a Wh-element may be fronted in Chinese under certain circumstances which are very similar to the circumstances in German (DRQ).¹⁵

- (16) a. *Shei mai-le shenme?*
who buy-ASP what
 'Who bought what?'
 b. *Shenme, shei mai-le t_i?*
what who buy-ASP
 '*What did who buy?'

As in German, the possibility of fronting is dependent on the context.¹⁶

(17) Situation I: *Zhangsan went to the supermarket.*

- a. *Zhangsan mai-le shenme?*
Zhangsan buy-ASP what
 'What did Zhangsan buy?'
 b. # *Shenme Zhangsan mai-le?*
what Zhangsan buy-ASP
 'What did Zhangsan buy?'

(18) Situation II: *Same as I but he bought items from a known list.*

Shenme Zhangsan mai-le?

With Wu we can analyse the fronted Wh-element as topicalized: note that it cannot be movement to CP, otherwise standard Wh-questions could not be explained (see fn. 15). This is exactly the proposal for German: both Wh-elements move to TopP to check off [Top], here taken to be the formal identification of DRQ; only the higher Wh-element moves further to CP to check [Wh], the Wh-feature marking the entire construction as an interrogative.

4 Some Concepts of Wh-Topics: The (Rough) Syntax

We now have an idea what Wh-topics in German Multiple Wh are: they are Wh-elements that check topichood prior to interrogativity. We also have a clue as to the whereabouts of [Top]: within a deeper, elaborate structure of partitives that on an abstract level underlies all Wh in German. [Top] marks the partitive part of the Wh-element; hence DRQ is satisfied by checking of [Top] and all DRQed Wh-elements in German (Multiple Wh) behave like partitive interrogatives. A reflex of this behaviour was witnessed for English.¹⁷

If [Top] and [Wh] are inherent to both Wh-elements, we can capture the derivation abstractly as in (19), focusing on the [Top]/[Wh]-interaction, and for some constructions shown in (20):

(19) [_{CP} Wh [_{TopP} t [_{TopP} Wh [_{TP} ...]]]]

- (20) a. [_{CP} Wen_i hat [_{TopP} t_j [_{TopP} was_k [_{TP} der Martin [_{FP} t_j [_{FP} t_k gegeben]]]]]]?
 b. [_{CP} Was_j hat [_{TopP} t_j [_{TopP} wen_k [_{TP} der Martin [_{FP} t_j [_{FP} t_k gegeben]]]]]]?
what has to-whom the Martin given
 'What did Martin give to whom?'

Again, the specific content of “FP” shall not be of concern here: the relevant steps in the derivation are raising of both Wh-elements from their respective positions in the T-domain to TopP to check off the feature [Top] and ultimately satisfy DRQ. The higher one further moves to SpecCP, thus satisfying any locality conditions on movement (if there are any¹⁸).¹⁹

One consequence of this approach is that non-interrogative subjects in between two Wh-topics must also be topicalized:²⁰

(21) [_{CP} Wer_i hat [_{TopP} t_i [_{TopP} was_j [_{TP} t_i [_{FP} t_j gekauft]]]]]]
 ‘Who bought what?’

(22) [_{CP} Was_i hat [_{TopP} t_j [_{TopP} Martin_i [_{TopP} wem_k [_{TP} t_i [_{FP} t_j [_{FP} t_k gegeben]]]]]]]]?]
 ‘What did Martin give to whom?’

This, of course, is not such an unreasonable assumption, given the well-known natural topicality of the subject in languages such as German which usually carries discourse-old information.

In sum, the approach argued for here accounts for apparent Superiority violations by obligatory topicalization of both Wh-elements where all movement operations conform locally to distance restrictions on movement. A more articulated structure of the C-domain à la Rizzi (1997) is needed anyway and the data presented so far support this view further (see Grohmann, in progress for a deeper discussion). Additional evidence will be provided below.

5 Some Consequences of DRQ: Quantifiers and Multiple Wh

I will now present some consequences of the DRQ-driven topicalization-approach to Multiple Wh in German laid out above which, at the same time, provides additional evidence in favour of it.

Beck (1996) discusses the following puzzle:²¹ subject quantifiers are ungrammatical in between two Wh-elements.

- (23) a. * Was hat niemand wann gekauft?
 what has nobody when bought
 ‘What did nobody buy when?’
 b. * Wem hat niemand was gegeben?
 to-whom has nobody what given
 ‘Who did nobody give what to?’

while they are fine following the two Wh:

- (24) a. Was hat wann niemand gekauft?
 b. Wem hat was niemand gegeben?

The paradigm from (23) and (24) stands in sharp contrast to (25):

- (25) a. Was hat Martin wann gekauft?
 b. Wem hat Martin was gegeben?

Thus, while a quantified subject in between the two Wh-elements leads to ungrammaticality, the presence of a non-quantified subject (such as a proper name) does not. Note that the co-occurrence of Wh-elements and quantifiers is not ungrammatical per se, as illustrated in (24).

The DRQ-approach pursued here analyses all Wh-elements in (23-25) to be Wh-topics: it follows that the quantified subject in (23) sits in TopP as well (as does the proper name in (25)), while it plausibly occupies SpecTP in (24). We might then argue that (23) is ruled out because quantifiers cannot be topicalized.

We know that quantifiers such as *niemand* or *nobody* make bad topics, as illustrated by the ungrammaticality of the following constructions, where the quantifier is topicalized (with or without co-reference with a resumptive pronoun, as in left-dislocated constructions):

- (26) a. * Nobody, Martin kissed (him/her)
 b. * No girl, Martin kissed (her)
 c. * Few girls, Martin kissed (them)
 d. * Barely any girl, Martin kissed (her)
 (27) a. * Niemanden (den) hat Martin geküßt
 b. * Kein Mädchen (das) hat Martin geküßt
 c. * Wenige Mädchen (die) hat Martin geküßt
 d. * Kaum ein Mädchen (das) hat Martin geküßt

A first stab at this phenomenon is thus that non-topicalizable elements may not intervene in between the two Wh-elements, which in turn supports the assumption that both Wh-elements have moved to TopP at some point.²²

On the other hand, constructions like (23) are grammatical when a different type of quantifier is used:

- (28) a. Was haben die meisten Mädchen wann gekauft?
what have the most girls when bought
 'What did most girls buy when?'
 b. Wem haben die meisten Mädchen was gegeben?
to-whom have the most girls what give
 'To whom did most girls give what?'

Other quantifiers make good topics: they can be freely topicalized:²³

- (29) a. All girls, Martin kissed (them)
 b. Each girl, Martin kissed (her)
 c. Many girls, Martin kissed (them)
 d. Most girls, Martin kissed (them)

- (30) a. Alle Mädchen (die) hat Martin geküßt
 b. Jedes Mädchen (das) hat Martin geküßt
 c. Viele Mädchen (die) hat Martin geküßt
 d. Die meisten Mädchen (die) hat Martin geküßt

The initial hypothesis regarding quantifier-interaction must thus be slightly revised: those quantifiers that cannot be topicalized cannot appear in between two Wh-elements in German Multiple Wh, while those that can be topicalized are fine in that configuration. The difference between both sets (in German as well as English) is that increasing quantifiers are topicalizable and hence expected to appear in between two Wh-elements, while decreasing quantifiers are not and their intervention leads to ungrammaticality.

Beck also discusses other types of Wh-quantifier interaction which mirror the above observation. On the one hand, the availability of a non-interrogative quantified subject inside a split partitive Wh serves as corroborative evidence in favour of the abstract partitive structure of Wh-elements in German Multiple Wh proposed here, as the same pattern emerges. Consider (31-32), where the split partitive Wh-phrase is italicized and the quantifier is marked boldface:

- (31) a. * *Wen hat **kein Student** von den Professoren gemocht?*
whom has no student of the professors liked
 'Which of the professors did no student like?'
 b. *Wen hat von den Professoren **kein Student** gemocht?*
 c. *Wen von den Professoren hat **kein Student** gemocht?*
 (32) a. *Wen hat **Martin** von den Professoren gemocht?*
 b. *Wen hat **jeder Student** von den Professoren gemocht?*
 c. *Wen (hat) von den Professoren (hat) **jeder Student** gemocht?*

As in the Multiple Wh-constructions from above, decreasing quantifiers in between the split partitive Wh-phrase are ungrammatical (31a), as opposed to increasing quantifiers (32b) or non-quantified subjects (32a); their presence is fine when they follow the partitive Wh-phrase which may be split (31b) or not (31c). Increasing quantifiers (or non-quantified subjects) may also appear after the partitive Wh of either type, of course (32c).

Lastly, the same pattern emerges in non-partitive Wh-phrases that are nevertheless complex and may be split.²⁴

- (33) a. * *Was hat **niemand** für Kurse besucht?*
what has nobody for courses visited
 'What kind of lectures did nobody go to?'
 b. *Was für Kurse hat niemand besucht?*
 (34) a. *Was hat **jeder** für Kurse besucht?*
 b. *Was für Kurse hat jeder besucht?*

The analysis for the constructions presented in this section follows immediately. Both Wh-elements move to TopP ([Top] for DRQ) before the higher one moves on to CP ([Wh] for interrogativity); intervening material has also moved to TopP. Decreasing quantifiers cannot be topicalized and are thus ungrammatical in between two Wh-elements but not following them: they stand in contrast to increasing quantifiers which can be topicalized and occur here.

The Wh-element in German may be split from the rest of the Wh-phrase in partitive interrogatives.²⁵ If the partitive part is indeed the locus of [Top] as argued here, it is not unreasonable to assume the partitive part to have moved to TopP and the interrogative part to CP. In this case, intervening material has also to occupy topic positions. The same dichotomy regarding quantified subjects can be observed in these cases: increasing quantifiers may appear between the Wh-element and its referring partitive, decreasing ones may not. The last case considered here concerns a similar splitting option for non-partitives, where the same pattern emerges yet again.

These instances not only support the general approach taken here under which they receive a straightforward explanation: they also offer further evidence in favour of the part of the analysis that concerns the locus of the topic-feature [Top]: with the cases of Wh-partitive/quantifier-interaction in mind, we can account for the possible intervening quantifier if the partitive has moved to TopP to check its referentiality, here taken to be [Top].

6 Conclusion

In this paper, I have argued for a strict discourse condition that underlies all Multiple Wh-constructions in German. I identified this condition as DRQ: in order to ask a question with two Wh-elements, (loose) reference to both Wh-elements must have been made in the discourse.

On a theoretical level, I suggested to implement DRQ syntactically through topicalization: both Wh-elements move overtly to TopP in the course of the derivation, an operation that satisfies locality conditions on movement. At TopP each Wh-element checks the topic-feature [Top], independently argued to be the syntactic property of DRQ. After this Wh-topicalization—for which we find evidence from other languages—DRQ is satisfied: only the higher of the two Wh-elements moves then on to CP to check the Wh-feature. One immediate consequence is that intervening material also topicalizes obligatorily: of particular interest are subjects.

One major empirical advantage of this approach I have looked at here concerns the presence of (quantified) subjects in between two Wh-elements: this approach captures these cases based on the well-known observation that increasing quantifiers—which happen to appear freely in between two Wh-elements—can be topicalized, while decreasing ones—those that may not intervene—cannot.

Notes

* I am particularly indebted to Werner Abraham, Juan Carlos Castillo, John Drury, Brigitta Hafika, Elena Herburger, Norbert Hornstein, Chris Kennedy, Howard Lasnik, David Lightfoot, Roland Meyer, Jim McCloskey, Karine Megerdooian, Ileana Paul, David Pesetsky, Paul Portner, Juan Uriagereka, Kai von Stechow and Gregory Ward for fruitful discussions, encouraging criticism and helpful advice (and above all, much needed support). I would like to extend my gratitude to the WECOL-audience (ASU, Tempe, October 9-11). The result is purely my fault regardless.

¹ Unless otherwise noted, I will employ this paradigm throughout: the German examples will appear without glosses as the equivalents of the English examples wherever possible.

² In order to keep the length of this paper somewhat under control, I will confine myself solely to the discussion of Wh-arguments such as (1) and (3); for discussion of the data concerning the interplay of Wh-adjuncts, see Grohmann 1998, section 3.

³ Chomsky (1973:246) formulates the Superiority Condition as follows:

- (i) a. No rule can involve X, Y in the structure ... X ... [₀ ... Z ...—WYV] ... where the rule applies ambiguously to Z and Y, and Z is superior to Y.
- b. The category A is 'superior' to the category B if every major category dominating A dominates B as well but not conversely.

I will refer to this definition as a simple descriptive statement about the data: as we can witness in German (3b), for example, it does not easily hold for other languages; however, (2a) possibly induces the necessity for elaboration even for English.

⁴ The interpretation to be yielded from all Multiple Wh considered here is distributive: a pair-list reading between the two Wh-elements must be construed. For semantic approaches to (Multiple Wh-)questions, see Karttunen 1977 among many others.

⁵ What is relevant here is some locality restriction on movement, in whichever way it may best be instantiated. The Minimal Link Condition, for instance, can be defined as follows (Chomsky 1995:311), where 'closeness' is defined as in (ii), according to Chomsky (1995:299) and Kitahara (1997:15):

- (i) K attracts α only if there is no β , β closer to K than α , such that K attracts β .
- (ii) β is closer to H(K) than α iff β c-commands α , and β is not in the minimal domain of CH, where CH is the chain headed by γ , and γ - α is adjoined to H(K).

It seems plausible that if these conditions apply to movement, they should apply universally, hence parameterization of some sort better not apply at this level.

⁶ In this sense, "scrambling" is not a unified operation; actually, it is not an operation at all but a cover term for (at least) two different syntactic operations: it refers to obligatory argument-raising out of VP into the T-domain on the one hand, and to topicalization into the C-domain on the other (where topicalization is used in a general sense, such as by Birner and Ward (1998)). In this respect, the often heard claim that scrambling and Wh-movement do not interact does not amount to much substance, as it relates a cover term for displacement to a specific displacement operation (e.g., Müller and Sternefeld 1993); consequently, I will not be concerned with this possible objection for the remainder.

⁷ For motivation of assuming a head-initial structure for VP, see the by now rich literature and arguments as contained in Zwart 1997 or Hinterhölzl 1998, for example.

⁸ Let us take FocP the locus of the feature [Wh], as cross-linguistically focus and Wh are in complementary distribution which can be witnessed in languages that have focus-morphemes (see Horvath 1986 for the original proposal; Megerdooian (1998) recently supports this generalization with data from Armenian). Relevant for current purposes is that there are a number of (recursive, as indicated by the Kleene star) TopP's in between the position that contains the Wh-feature and TP, the boundary between the C- and the T-domains. For the sake of simplicity, I will continue to refer to the Wh-position as CP (but see Grohmann, to appear for good reasons not to).

⁹ Bulgarian is a representative of languages that front all Wh-elements obligatorily in Multiple Wh-constructions: see, e.g., Boskovic 1998, Richards 1997, Rudin 1988.

¹⁰ Again, I confine myself here to the simple case of subject-Wh and object-Wh.

¹¹ The relevance of these "partitive Wh-phrases" will become evident in the next section.

¹² Further examples are the following (see also Grohmann 1998, section 3):

(i) *More possibilities of the type Situation I*

- a. "I know that students kissed (but not each other)."
- b. "I know that three students kissed (but not each other)."
- c. "I know that certain students kissed (but not each other)."
- d. "I know that Albert and others kissed (but not each other)."

(ii) *More possibilities of the type Situation II*

- a. "Students kissed (some) professors."
- b. "Three students kissed three professors."
- c. "Certain students kissed certain professors."
- d. "Albert and others kissed Xavier and others."

¹³ DRQ is presumably not at work in English, at least not in the same way as it is in German. Remnants of DRQ can, however, even be observed in some English dialects. This observation has to remain a puzzle to be discussed and solved at another time.

¹⁴ Note that with this notion we can also capture dialectal variation in English: speakers who allow more freedom with D-linked or even bare Wh-elements, might adopt the "German strategy" to some degree; I thank Bruce Morén for crucial observations.

¹⁵ At least since Huang 1982 it is assumed that Wh-expressions in Chinese do not move; Wu argues that in these cases, they do not move for Wh-checking purposes. This is desirable: if the language does not make the overt displacement of Wh-elements for this purpose available, this type of fronting should not take place for this reason. This suggests that another feature needs to be involved, which as Wu argues is [Top].

¹⁶ Wu shows that a distributive interpretation of Chinese Wh-topics is not available here.

¹⁷ There are more instances of the greater freedom that partitives exhibit in English. Some have been discussed by Kiss (1993), others by Grohmann (to appear, in progress).

¹⁸ Norbert Hornstein suggests in recent class lectures that there might actually be no formal locality conditions on movement as stipulated by the MLC; rather, every element moves the shortest distance it can. Note that this view disposes of the version of movement suggested by Attract; rather it is a return to the classical operation Move α where movement is motivated by the needs of the moved element only, not the target position. The main evidence in favour of Attract, he argues, comes from Superiority effects which he independently dispenses with (cf. Hornstein 1995 which contains an explicit approach to Multiple Wh based on Chierchia's (1991) notion of functional Wh; interestingly, this approach is not incompatible with DRQ).

¹⁹ Note that movement of the Wh-elements out of TP is indeed equidistant, although their paths are crossing (in the sense of Richards 1997, though without assuming multiple specifiers: movement out of the T-domain into the C-domain concerns closely related projections). Crucial is the well-formedness of all movement operations assumed here.

²⁰ As must any material in between the two Wh-elements, I will not discuss these instances of multiple topicalization further; it suffices to mention the possibility of "massive pied-piping" made available by many languages. (For instance, Etxepare (1998) discusses some interesting facts in Basque, Vallduvi (1997) in Catalan and Grohmann (1998, in progress) lays out the specifics for the present issues in more detail.)

²¹ Beck's data comprise of more than the bits presented here, some of which relevant to the present discussion, others not. I will only look at an alternative treatment of the cases shown here to keep the discussion in a manageable size.

The same reason also prohibits me from any discussion of Beck's analysis, other than briefly mentioned in the text. It shall be noted that she does not adopt the minimalist analysis employed here which thus motivates the following discussion independently (which, of course, should only be taken to mean that it offers a further topic for study within minimalism and not concerning qualitative differences regarding pre-minimalism).

²² Beck's approach makes use of the fact that negative islands often create "barriers" for movement and she argues in favour of a barriers-based prohibition on intervention in these cases. Apart from lack of theoretical appeal (especially in a minimalist framework that dispenses with barriers), further stipulations that she needs to make the analysis work are not needed here (e.g., not all prohibited intervening material is negative); the facts follow straightforwardly from the already supported assumptions.

Also, the negation-based account that extends to simple negation such as *nicht* 'not' runs into difficulties in passive-constructions even without two Wh-elements; further discussion would drift off too far (see Grohmann, in progress).

²³ The referents of the quantifiers must have been introduced in the discourse, i.e. they have to be known to some degree; only if they are referential are resumptive pronouns acceptable, picking out a specific group of referents (from a possibly larger one). Thus, in the current example the reference of *girls* is restricted to a specific group that speaker and hearer have in mind of which the quantifier picks out the relevant set.

²⁴ There are a number of complex Wh-phrases in German that may be split (all taken from Pafel 1996:145-146): *was für*-phrases (*Was haben damals für Leute protestiert?* ‘What kind of people protested back then?’), *w- alles*-phrases (*Wer hat den Minister alles zum Rücktritt gezwungen?* ‘Who all forced the minister to resign?’), partitive Wh-phrases (*Wieviele haben sich von Euch gemeldet?* ‘How many of you answered?’), *w- an*-phrases (*Was hat jeder an Aufgaben gelöst?* ‘How many problems did everyone solve?’) and *w- adjective*-phrases (*Was ist Neues passiert?* ‘What’s new?’). For an overview of extraction out of NPs in German, see Pafel 1996 and references cited there.

With respect to the present issues, all those extractable Wh-phrases follow the pattern described here, i.e. only topicalizable material may intervene.

²⁵ It is irrelevant for present purposes whether this split is the result of “extraction” (in the technical sense) or not. Notice that an extraction-approach might run into difficulties in these cases: it looks very much like extraction out of a left branch, independently undesirable, following Ross’ (1967) “Left Branch Condition” and also more recent treatments by Corver (1990), Uriagereka (1998) and many others.

References

- Beck, Sigrid. 1996. Quantified Structures as Barriers for LF-Movement. *Natural Language Semantics* 4.1: 1-56.
- Birner, Betty J and Gregory Ward. 1998. *Information Status and Noncanonical Word Order in English*. Amsterdam: John Benjamins.
- Boskovic, Željko. 1993. On Certain Violations of the Superiority Condition, AgrO, and Economy of Derivation. *Journal of Linguistics* 33.2: 227-254.
- Boskovic, Željko. 1998. Wh-Phrases and Wh-Movement in Slavic. Manuscript, University of Connecticut, Storrs.
- Chierchia, Gennaro. 1991. Functional Wh and Weak Crossover. *Proceedings of the Tenth West Coast Conference in Formal Linguistics*. Stanford: CSLI. 75-90.
- Chomsky, Noam. 1973. Conditions on Transformations. In S.R. Anderson and P. Kiparsky (eds.), *A Festschrift for Morris Halle*. New York: Holt, Reinhart and Winston. 232-286.
- Chomsky, Noam. 1995. *The Minimalist Program*. Cambridge, MA: MIT Press.
- Corver, Norbert. 1990. *The Syntax of Left Branch Extraction*. Doctoral Dissertation, Katholieke Universiteit Brabant, The Netherlands.
- Ettxepare, Ricardo. 1998. Paratactic Dependents and Covert Merge. Talk presented at *GLOW 21*, Tilburg, April 15-17.
- Grohmann, Kleanthes K. 1996. Some Remarks on the West Germanic *Mittelfeld*: Scrambling, Case and Pronominalization. BA Honours Dissertation, University of Wales, Bangor.
- Grohmann, Kleanthes K. 1997a. On Left Dislocation. In W. Abraham and K.K. Grohmann (eds.), *Groninger Arbeiten zur germanistischen Linguistik* 40. 1-33.
- Grohmann, Kleanthes K. 1997b. Pronouns and the Left Periphery of West Germanic Embedded Clauses. In W. Abraham and E. van Gelderen (eds.), *German: Syntactic Problems—Problematic Syntax*. Tübingen Niemeyer. 163-189.

Grohmann, Kleanthes K. 1998. Syntactic Inquiries into Discourse-Restricted Quantification on Multiple Interrogatives. In W. Abraham (ed.), *Groninger Arbeiten zur germanistischen Linguistik* 42, 1-60.

Grohmann, Kleanthes K. To Appear. More Extractions with More Questions: DRQ. Multiple Wh and Wh-Islands. *University of Maryland Working Papers in Linguistics* 8.

Grohmann, Kleanthes K. In Progress. *Prolific Peripheries: A Radical View from the Left*. Doctoral Dissertation, University of Maryland, College Park.

Hinterhölzl, Reinhold. 1998. *Restructuring Infinitives and the Theory of Complementation*. Doctoral Dissertation, University of Southern California, Los Angeles.

Hornstein, Norbert 1995. *Logical Form: From GB to Minimalism*. Oxford: Blackwell.

Horvath, Julia. 1986. *FOCUS in the Theory of Grammar and the Syntax of Hungarian*. Dordrecht: Foris.

Huang, C.-T. James. 1982. *Logical Relations in Chinese and the Theory of Grammar*. Doctoral Dissertation, Massachusetts Institute of Technology, Cambridge.

Karttunen, Lauri. 1977. Syntax and Semantics of Questions. *Linguistics and Philosophy* 1.1: 3-44.

É. Kiss, Katalin. 1993. Wh-Movement and Specificity. *Natural Language and Linguistic Theory* 11.1: 85-120.

Kitahara, Hisatsugu. 1997. *Elementary Operations and Optimal Derivations*. Cambridge, MA: MIT Press.

Megerdooimian, Karine. 1998. Wh-Words: A Decomposition of the [-Wh]-Feature. Talk presented at LASSO 27 (Arizona State University, Tempe, October 9-11).

Müller, Gereon and Wolfgang Sternefeld. 1993. Improper Movement and Unambiguous Binding. *Linguistic Inquiry* 24.4: 461-507.

Pafel, Jürgen. 1996. Kinds of Extraction from Noun Phrases. In U. Lutz and J. Pafel (eds.), *On Extraction and Extraposition in German*. Amsterdam: John Benjamins. 145-177.

Pesetsky, David. 1987. *Wh-in situ: Movement and Unselective Binding*. In A.G.B. ter Meulen and E. Reuland (eds.), *The Representation of (In)definiteness*. Cambridge, MA: MIT Press. 98-129.

Richards, Norvin. 1997. *What Moves Where When in Which Language?* Doctoral Dissertation, Massachusetts Institute of Technology, Cambridge.

Rizzi, Luigi. 1997. The Fine Structure of the Left Periphery. In L. Haegeman (ed.), *Elements of Grammar: A Handbook of Generative Syntax*. Dordrecht: Kluwer. 281-337.

Ross, John R. 1967. *Constraints on Variables in Syntax*. Doctoral Dissertation, Massachusetts Institute of Technology, Cambridge.

Rudin, Catherine. 1988. On Multiple Questions and Multiple Wh-Fronting. *Natural Language and Linguistic Theory* 6.4:445-501.

Takahashi, Daiko. 1993. Movement of Wh-Phrases in Japanese. *Natural Language and Linguistic Theory* 11.4: 655-678.

Uriagereka, Juan. 1998. Multiple Spell-Out. Manuscript, University of Maryland, College Park. [To Appear in S.D. Epstein and N. Hornstein (eds.), *Working Minimalism*. Cambridge, MA: MIT Press]

Vallduvi, Enric. 1996. Structural Properties of Information Packaging in Catalan. In K.E. Kiss (ed.), *Discourse Configurational Languages*. Oxford: Oxford University Press. 122-152.

Wu, Jianxin. 1996. Wh-Topic, Wh-Focus and Wh-*In situ*. In J.C. Castillo, V. Miglio and J. Musolino (eds.), *University of Maryland Working Papers in Linguistics 4*: 173-192.

Zwart, C. Jan-Wouter. 1997. *Morphosyntax of Verb Movement: A Minimalist Approach to the Syntax of Dutch*. Dordrecht: Kluwer.

*Kleanthes K. Grohmann
University of Maryland
Department of Linguistics
1401 Marie Mount Hall
College Park, MD 20742
grohmann@wam.umd.edu*

Hopi Nominal Reduplication Without Templates

Sean Hendricks
U. of Arizona

1. Introduction

In Hopi, a Uto-Aztecan language, a set of nouns is marked as plural by reduplication. There are three main types of reduplication that I investigate in this paper. I analyze this reduplication as a prefix to the root. The patterns can be illustrated by the following sets of data. Figures (1) and (2) illustrate the reduplication of a form with an initial CV syllable. I refer to this pattern as CV-reduplication, based upon the shape of the initial syllable. In (1), the root has an initial CV syllable and a following CV syllable. All data are from Jeanne (1978).

(1) CV-Reduplication I

como	'hill'	→	<u>co</u> -c-mo
koho	'wood'	→	<u>ko</u> -k-ho
sihi	'flower'	→	<u>si</u> -s-hi
leji	'tongue'	→	<u>le</u> -l-ji
laho	'bucket'	→	<u>la</u> -l-ho
poyo	'knife'	→	<u>po</u> -p-yo
k ^w asa	'dress'	→	<u>k^wa</u> -k ^w -sa
tamö	'knee'	→	<u>ta</u> -t-mö
siri	'tail'	→	<u>si</u> -s-ri
tama	'teeth'	→	<u>ta</u> -t-ma
kiyapi	'dipper'	→	<u>ki</u> -k-yapi
yiŋ ^y api	'plaque'	→	<u>yi</u> -y-ŋ ^y api
pitanakci	'hat'	→	<u>pi</u> -p-tanakci
qötösompi	'headband'	→	<u>qö</u> -q-tösompi

In CV-reduplication, the reduplicant surfaces as the onset and nucleus of an initial CVC syllable. The base undergoes syncope of the first root vowel.

Figure (2) illustrates the reduplication of a form with an initial CV syllable and a following CVC syllable:

(2) CV-Reduplication II

caqapta	'dish'	→	<u>ca</u> -cqapta
panapca	'window'	→	<u>pa</u> -pnapca
mōcikvi	'trash'	→	<u>mō</u> -mcikvi
mirikho	'hunting stick'	→	<u>mi</u> -mrikho
kawayvatŋa	'watermelon'	→	<u>ka</u> -kwayvatŋa

Just as in (1), the reduplicant surfaces as a CV sequence of an initial CVC syllable. Again, the root undergoes syncope of the initial vowel.

Figure (3) illustrates the reduplication of a form with an initial CVV syllable, which I refer to as CVV-reduplication, based upon the shape of the initial syllable of the unreduplicated root.

(3) CVV-Reduplication

saaqa	'ladder'	→	<u>saa</u> -saqa
tooci	'shoe'	→	<u>too</u> -toci
siivi	'pot'	→	<u>sii</u> -sivi
sooya	'planting stick'	→	<u>soo</u> -soya
?aaya	'rattle'	→	? <u>aa</u> -?aya
soohi	'star'	→	<u>soo</u> -sohi
noova	'food'	→	<u>noo</u> -nova
siiva	'metal'	→	<u>sii</u> -siva
moosa	'cat'	→	<u>moo</u> -mosa

In CVV-reduplication, the reduplicant surfaces as a CVV syllable, while the root undergoes shortening of the initial vowel.

Figure (4) illustrates the pattern of reduplication in a root with an initial CVC syllable, referred to as CVC-reduplication, based upon the shape of the syllable of the unreduplicated root:

(4) CVC-Reduplication

naqvi	'ear'	naa -naqvi
tisna	'body dirt'	ti -tisna
napna	'shirt'	naa -napna
ɲimni	'flour'	ɲi -ɲimni

In CVC-reduplication, the reduplicant surfaces as a CVV syllable, and the root does not undergo any change.

The following table shows the possible reduplicant shapes and the effect on the base:

(5) Prosodic Analysis

Reduplication Type	Reduplicant Shape	Effect on Base
CV	CV	syncope
CVV	CVV	shortening
CVC	CVV	-

As the table shows, the shape of the reduplicant is not consistent throughout the paradigm. The reduplicant varies between a light CV syllable and a heavy CVV syllable. This presents a difficulty if the shape of the reduplicant is determined by mapping to a single prosodic template. If there is a single template, then there must be higher-ranked constraints that do not allow the templatic constraint to be satisfied.

Further, in observing the data, one can see that sometimes the reduplicant is not coextensive with a single prosodic unit. For example, in *cocmo* 'hills', the reduplicant is a CV sequence, but this sequence is part of a CVC heavy syllable, not a light syllable in and of itself. Figure (6) illustrates this:

(6) Prosodic Mismatch:

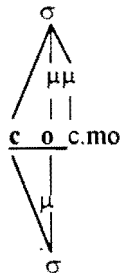

In figure (6), the prosodic structure of the first syllable of the reduplicated noun is above the form, while the prosodic structure of the reduplicant sequence is

below the form. The reduplicant has a light syllable structure that is not part of the full reduplicated form. Therefore, providing a template for the reduplicant that can be satisfied on the surface is impossible, as the prosody unique to the reduplicant cannot be coextensive with the prosody of the entire form.¹

In 2, I present an analysis of Hopi reduplicated nouns in the framework of Optimality Theory (Prince & Smolensky 1993, McCarthy & Prince 1993a). For this analysis, I propose an account that does not rely upon a prosodic template. This account allows for the variation in reduplicant shape without relying upon a constraint that becomes irrelevant in some of the reduplicants of the paradigm. It also renders the templatic mismatch relevant in some cases.

2. Analysis of Hopi Nominal Reduplication

2.1. Position and edge-matching

Among all instances of reduplication given in this paper, there are two generalizations that I account for in this section, and they are given in (7) below:

- (7) Generalizations
- (a) the reduplicant is a prefix to the root
 - (b) the left edge of the reduplicant matches the left edge of the root

The generalization in (7)(a) is accounted for in section 2.1.1, and generalization (7)(b) is accounted for in section 2.1.2.

2.1.1. *Placement of the Reduplicant: ALIGN-RED-L >> ALIGN-Root-L*

The first generalization can be captured by the appropriate ranking of alignment constraints pertaining to the root and the reduplicant. Such constraints are defined in terms of Generalized Alignment (McCarthy & Prince 1993b). This account of placement is consistent with a theory of reduplication presented in Hendricks (forthcoming), in which the ordering of morphemes in a form is determined by the relative rankings of constraints that align a morpheme to the edge of a word. Such constraints have the following definition:

- (8) ALIGN-Morpheme-L²
Align (Morpheme, L, Word, L)
Align the left edge of a morpheme to the left edge of a word.

In this instance, the appropriate alignment constraints are ALIGN-RED-L and ALIGN-Root-L. Since the reduplicant is prefixed to the root, then the constraints

ALIGN-RED-L and ALIGN-Root-L must have the following ranking: ALIGN-RED-L >> ALIGN-Root-L. The following tableau illustrates for the form *naqvi* 'ear' (at this point, I do not account for the shape of the reduplicant):

(9) ALIGN-RED-L >> ALIGN-Root-L

/naqvi, RED/	ALIGN-RED-L	ALIGN-Root-L
☞ a. <u>naa</u> -naq.vi		naa
b. naq.vi- <u>naa</u>	n!aqvi	
c. naq- <u>naa</u> -vi	n!aq	

In tableau (9), the failure of candidate (b) illustrates the effectiveness of the ranking ALIGN-RED-L >> ALIGN-Root-L. This candidate fails because the reduplicant is suffixed to the root, incurring violations of ALIGN-RED-L, since the reduplicant is not aligned to the left edge. Candidate (c), in which the reduplicant is infixes to the root, fails for the same reason. Candidate (a) is chosen because it does not violate ALIGN-RED-L, even at the expense of violations of ALIGN-Root-L.

2.1.2. *Edge-Matching of the Reduplicant: LEFT-ANCHOR(B,R)*

The second generalization to be accounted for pertains to the matching of left edges between the root and the reduplicant. This edge-matching falls under the domain of the ANCHOR schema of Correspondence Theory constraints (McCarthy & Prince 1995). Since the edges that match are at the left edge, the appropriate constraint is L(EFT)-ANCHOR(B,R), defined as the following:

(10) L(EFT)-ANCHOR(B,R)

An element at the left edge of the base must have a corresponding element at the left edge of the reduplicant.

Since the reduplicant attaches to the root, and the input minus the reduplicant is the root, then I define the base for reduplication as the root. The following tableau illustrates:

(11) L-ANCHOR(B,R), ALIGN-RED-L >> ALIGN-Root-L

/naqvi, RED/	L-ANCHOR(B,R)	ALIGN-RED-L	ALIGN-Root-L
☞ a. <u>naa</u> -naqvi			naa
b. <u>vaa</u> -naq.vi	*!		vaa
c. <u>kaa</u> -naq.vi	*!		kaa

In this tableau, candidate (b) fails to satisfy L-ANCHOR(B,R) because the left edge of the reduplicant matches a consonant closer to the right edge of the base. Candidate (c) fails to satisfy anchoring, as the reduplicant does not correspond

either to the segment at the left edge of the base, or any other segment of the base. Therefore, both candidates are ruled out.

2.2. Shape of the reduplicant

Hopi reduplicants do not circumscribe a consistent prosodic unit across the paradigm. Also, the reduplicants are not always coextensive with a unique prosodic unit. For both reasons, it seems clear that an analysis without a prosodic template would be beneficial to an account of Hopi reduplication. In this section, I provide such an analysis.

In Hendricks (forthcoming), I propose that the shape of a reduplicant can be determined by competition between the root and the reduplicant for alignment to the left edge. Therefore, the reduplicant surfaces as minimally as possible to satisfy exponence and syllable structure. The following tableau illustrates the evaluation of candidates for CVC-reduplication by the relative rankings of ALIGN-RED-L and ALIGN-Root-L:

(12) Analysis of Shape without Prosodic Template

/naqvi. RED/	L-ANCHOR(B,R)	ALIGN-RED-L	ALIGN-Root-L
⊛ a. <u>n</u> -naq.vi			n
b. <u>na</u> -.naq.vi			n!a
⊘ c. <u>naa</u> -.naq.vi			n!aa
d. <u>naq</u> -.naq.vi			n!aq
e. <u>naqv</u> -.naq.vi			n!aqv
f. <u>naq.vi</u> -.naq.vi			n!aqvi

In tableau (12), candidate (a) is incorrectly chosen as optimal, as it incurs the fewest violations of ALIGN-Root-L. All other candidates, including the actual surface candidate (b), are eliminated by fatal violations of ALIGN-Root-L.

In order to eliminate a candidate such as (12)(a) from competition, I turn to constraints upon the syllable structure of Hopi. In Hopi, there is a general avoidance of tautosyllabic consonant clusters (Sekaqwaptewa, pc), which can be regulated by the constraint *CC, defined below:

- (13) *CC
No tautosyllabic consonant clusters.

Since candidate (12)(a) surfaces with such a cluster, it will be eliminated by *CC. This constraint must be ranked higher than ALIGN-Root-L, as shown in tableau (14):

(14) No Clusters

/naqvi, RED/	L- ANCH(B,R)	*CC	ALIGN-RED-L	ALIGN-Root-L
a. <u>n</u> -naq.vi		*!		n
⊙ b. <u>na</u> -naq.vi				na
☞ c. <u>naa</u> -naq.vi				na!a
d. <u>naq</u> -naq.vi				na!q
e. <u>naqv</u> -naq.vi		*!		naqv
f. <u>naq.vi</u> -naq.vi				na!qvi

In tableau (14), candidate (a) is eliminated by the fatal violation of *CC, even though this candidate incurs fewer violations of ALIGN-Root-L. However, candidate (b) is incorrectly chosen, as it incurs minimal violations of ALIGN-Root-L, while satisfying *CC. Candidate (c) is still the correct surface candidate.

The solution to this dilemma can be found by observing the prosodic status of the initial syllable in all reduplicative patterns, as shown below:

(15) Initial Syllables in Reduplicated Plurals

coc.mo
saa.sa.qa
naa.naq.vi

In all cases, the initial syllable of the reduplicated form is either CVC or CVV. If codas in Hopi are moraic, one can generalize that the initial syllable of a plural form is a heavy syllable.

It turns out that there is good evidence that codas are moraic in Hopi. Some of this evidence comes from the stress system of Hopi. Data such as those given in (16) suggest that in polysyllabic forms, stress appears on the second syllable from the left:

(16) Stress in polysyllabic forms

kiyápi 'dipper'
caqápta 'dish'
panápca 'window'
laqána 'squirrel'
qötôsompí 'headband'
koyógo 'turkey'

Jeanne (1978: 33-34)

However, if a polysyllabic form has a CVV syllable in initial position, the stress appears on that syllable, as shown by the following data:

(17) Attraction of stress to CVV syllables

tííwkavi ³	'necklace'	
paáwikya	'duck'	
naáwisi	'to comb one's hair'	Jeanne (1976: 34)

Such data indicates that a bimoraic syllable attracts stress. The following data shows that CVC syllables also attract stress:

(18) Attraction of stress to CVC syllables

?ácwewa	'chair'	
léstavi	'viga, roof beam'	
cáyhoya	'child (diminutive)'	Jeanne (1978: 35)

Since CVC syllables also attract stress, like CVV syllables, then they must also be bimoraic. Therefore, codas are moraic in Hopi.

Another piece of evidence comes from a vowel-shortening process in Hopi. Observe the following data:

(19) Vowel Shortening

<u>non-future</u>	<u>future</u>	
?íiya	?íy-ni	'plant'
nöösa	nös-ni	'eat'
piíwi	piw-ni	'sleep'
qaaci	qac-ni	'be in position' Jeanne (1978: 17)

When the future marker *-ni* is added to certain stems, the final vowel does not surface. This causes the final consonant to become the coda of the previous syllable. However, forms such as **qaacni* do not surface. Instead, the long vowel of the bare stem surfaces as monomoraic in the future form. If codas are moraic, then this can be accounted for by a restriction in Hopi that bars trimoraic syllables (* $\sigma_{\mu\mu\mu}$).

Since codas are moraic, then the observation in (15) can be characterized by stating that all reduplicative plural forms in Hopi have an initial heavy syllable. This fact can be accounted for straightforwardly by a constraint which ensures that plural forms have a heavy syllable on the left edge. More specifically, the

reduplicant, which is at the left edge, must be aligned with the left edge of a heavy syllable, as shown below:

- (20) ALIGN-RED- σ_{μ} -L
 Align (RED, L, σ_{μ} , L)
 Align the left edge of a reduplicant to the left edge of a heavy syllable.

This constraint is similar to a prosodic template, but there are important differences.

One difference is that it makes use of the machinery of Generalized Alignment, a constraint schema that has been shown to be useful in a number of linguistic arenas, whereas templatic constraints have a more limited field of use, mapping a morphological category to a prosodic category in its entirety. Another difference is that it only defines one edge, whereas a templatic constraint defines both left and right edges at the same time. With a template, the morphological exponent must be defined entirely by a single prosodic unit. As discussed above, the Hopi reduplicant does not always surface as a heavy syllable and the reduplicant itself is not always a self-contained prosodic unit.

The constraint ALIGN-RED- σ_{μ} -L must be ranked above ALIGN-Root-L, so that the reduplicant can copy enough to satisfy the heavy syllable requirement. The following tableau shows the interaction of this constraint with the candidates presented thus far:

(21) Heavy Syllable Plural: ALIGN-RED- σ_{μ} -L

/naqvi. RED/	L- ANCH(B,R)	*CC	ALIGN- RED- σ_{μ} -L	ALIGN- RED-L	ALIGN- Root-L
a. <u>na</u> -naq.vi			*!		<u>na</u>
b. <u>naa</u> -naq.vi					naa
c. <u>naq</u> -naq.vi					naq
d. <u>naqvi</u> -naq.vi					naqv'i
e. <u>na</u> -nq.vi		*!			<u>na</u>
f. <u>na</u> -n.qvi		*!			<u>na</u>

As tableau (21) shows, the CV candidate (a) is eliminated as the left edge does not define a heavy syllable. Candidate (d) is eliminated by the fatal violations of ALIGN-Root-L. Candidates (e) and (f) show that candidates that syncopate in the root to satisfy the heavy syllable requirement are eliminated by *CC. However, the current ranking still chooses both (b) and (c) as optimal.

Candidates (21)(b) and (21)(c) each include a heavy-syllable reduplicant that satisfies ALIGN-RED- σ_{μ} -L. Candidate (21)(b) lengthens the vowel, while candidate (21)(c) is more faithful to the root. As one reduplicant is a heavy

CVV syllable, and the other reduplicant is a heavy CVC syllable, the main difference is the segmental structure of the reduplicant. Observe the following:

(22) Prosodic structure of CVV and CVC syllables

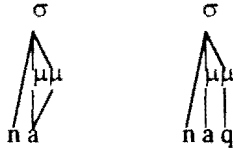

As the diagrams in (22) show, the long vowel reduplicant is composed of two segments, while the CVC reduplicant is composed of three segments. If alignment is evaluated in terms of segments, then the following is the evaluation of the candidate set under the current ranking:

(23) Segmental evaluation of ALIGN

/naqvi, RED/	L-ANCH(B,R)	*CC	ALIGN-RED-σ _μ -L	ALIGN-RED-L	ALIGN-Root-L
a. <u>na</u> .-naq.vi			*!		na
♣ b. <u>naa</u> .-naq.vi					na
c. <u>naq</u> .-naq.vi					naq!

Under this evaluation, the correct candidate (b) is chosen as optimal, as it incurs fewer violations of ALIGN-Root-L than candidate (c), in which the reduplicant is a CVC syllable.

The generalizations that must be accounted for in CVV-reduplication are the same as for CVC with one exception. In CVV-reduplication, there is vowel shortening in the root. The current ranking for CVC-reduplication should account for CVV as well. The following tableau illustrates the evaluation of candidates for the reduplicated form of *saaqa* 'ladder':

(24) Initial evaluation of CVV-reduplication

/saaqa, RED/	L-ANCH(B,R)	*CC	ALIGN-RED-σ _μ -L	ALIGN-RED-L	ALIGN-Root-L
a. <u>s</u> -saa.qa		*!			s
b. <u>sa</u> .-saa.qa			*!		sa
⊗ c. <u>saa</u> .-saa.qa					sa
d. <u>saa.qa</u> .-saa.qa					saq!a
♣ e. <u>saa</u> .- <u>sa</u> .qa					sa
⊗ f. <u>sa</u> -s.qa					sa

Tableau (24) shows that candidates (c), (e), and (f) are all chosen as optimal, as they all incur two violations of ALIGN-Root-L. However, only candidate (e) is the true surface candidate.

In order to allow a candidate such as (24)(e) to be chosen as optimal, a candidate such as (24)(f) must be eliminated. The distinctive characteristic of candidate (24)(f) is the deletion of the long vowel in the root. Therefore, candidate (24)(f) can be eliminated by a constraint against deletion. Such phenomena are regulated by the MAX schema of Correspondence Theory constraints (McCarthy & Prince 1995). In this case, the output root does not have the same number of corresponding segments as the input root. Therefore, the instantiation of MAX is MAX_{IO}, defined below:

- (25) MAX_{IO}
Every element in the input must have a corresponding element in the output.

The ranking of this constraint is not crucial, so I rank it with ALIGN-Root-L. The following tableau illustrates the interaction of this constraint:

(26) Elimination of syncope: MAX_{IO}

/saaqa, RED/	L-ANCH (B.R)	*CC	ALIGN-RED-σ _{HL} -L	ALIGN-RED-L	ALIGN-Root-L	MAX _{IO}
a. <u>sa</u> -saa.qa			*!		sa	
⊕ b. <u>saa</u> -saa.qa					sa	
c. <u>saa.qa</u> -saa.qa					saq!a	
☞ d. <u>saa</u> -sa.qa					sa	*!
e. <u>sa</u> -s.qa					sa	*!*

As tableau (26) shows, candidates (d) and (e) are eliminated by MAX_{IO}. However, this allows the incorrect candidate (b) to be chosen as optimal, while the true surface candidate (c) is incorrectly eliminated.

It is clear that the constraint ranking should bar syncope, but allow vowel shortening. Therefore, there must be some other constraint that candidate (26)(b) violates that allows minimal violations of MAX_{IO}. I propose that the resolution lies in the stress pattern of Hopi, as discussed in section 2.1. The reason the root vowel shortens is to avoid two adjacent heavy syllables.

2.2.1. *Vowel Shortening: Evidence from Stress*

One of the crucial stress facts of Hopi in the current circumstance is the fact that heavy syllables attract stress. This fact can be captured by the following:

- (27) WSP (Weight-to-Stress Principle)
Heavy syllables must be stressed.

By this constraint, if a syllable is heavy, then it must be stressed. The following tableau illustrates:

(28) Weight-to-Stress Principle

/saaqa, RED/	WSP	L-ANCH (B,R)	*CC	AL-RED- $\sigma_{\text{H}}-L$	AL-RED -L	AL-Root-L	MAX _{IO}
a. <u>sa</u> -saa.qa				*!		sa	
b. <u>saa</u> -saa.qa	*!					sa	
c. <u>saa</u> -saa.qa	*!					sa	
⊙ d. <u>saa</u> -saa.qa						sa	
☞ e. <u>saa</u> -sa.qa						sa	*!
f. <u>sá</u> -s.qa						sa	*!*

Tableau (28) shows that candidates that have two heavy syllables, but only one stress, incur violations of WSP. However, candidate (d) is still chosen as optimal.

Candidates (28)(d) and (28)(e) both satisfy WSP. Candidate (28)(d) fully satisfies WSP by stressing both heavy syllables, while candidate (28)(e) fully satisfies WSP by shortening the root vowel, incurring a violation of MAX_{IO}. Therefore, in order for (28)(c) to be chosen, there must be a constraint that disallows two stresses. As shown in section 2.1, stress is assigned to either the initial or peninitial syllable, regardless of the length of the form. Therefore, it seems clear that stress must be assigned from the left. If footed syllables get stressed, then the following constraint regulates leftward stress assignment:

- (29) ALIGN- Σ -L
Align (Σ , L, Word, L)
Align the left edge of every foot to the left edge of the word.

The following tableau illustrates the interaction of ALIGN- Σ -L (I no longer consider the candidates that violate *CC and L-ANCHOR(B,R), for convenience):

(30) Leftward Stress Assignment

/saaqa, RED/	AL- Σ-L	WSP	AL-RED- σ _μ -L	AL- RED-L	AL- Root-L	MAX IO
a. (sáa.)-saa.qa		*!			sa	
b. saa.-(sáa.)qa	σ!	*!			sa	
c. (sáa.)-(sáa.)qa	σ!				sa	
☞ d. (sáa.)-sa.qa					sa	*
e. (sá-s.)qa					sa	*!*

As tableau (30) shows, candidate (d), which is the true surface form, is chosen as optimal in order to satisfy ALIGN-Σ-L and WSP. Both constraints must be ranked higher than MAX_{IO}, in order to ensure that candidates (a) and (c) are not in competition. Therefore, the pattern of CVV-reduplication is accounted for, including the shape of the reduplicant, without the use of a prosodic template.

However, in CVC-reduplication, the correct form is of a shape such as *nánaqvi*, in which there are two heavy syllables, but only one stress. In order to allow this type of form, there must be a constraint that does not allow the second syllable to be shortened. The primary difference between CVC and CVV-reduplication is that the second syllable in CVC-reduplication has a coda. Therefore, the deletion of a consonant must be eliminated, while still allowing the shortening of a vowel. The most obvious solution is to separate out consonantal faithfulness from the more general faithfulness constraints. This faithfulness can be defined by the following subcategorization of MAX_{IO}:

(31) MAX_{IO}-C

Every consonantal segment in the input must have a corresponding consonantal segment in the output.

By placing this constraint higher than WSP, violations of WSP are allowed, in order to maintain consonantal faithfulness. The following tableau illustrates the interaction of MAX_{IO}-C with candidates for CVC-reduplication:

(32) Consonantal Faithfulness

/naqvi, RED/	MAX IO-C	AL -Σ- L	WSP	AL- RED- σ _μ -L	AL- RED- -L	AL- Root-L	MAX IO
☞ a. (náa.)-naq.vi			*			na	
b. (náa.)-na.vi	*!					na	*
c. (náa.)-(náq.)vi		σ!				na	

As the above tableau shows, the correct candidate (a) is chosen as optimal, at the expense of a violation of WSP. The elimination of candidate (c) shows that

ALIGN- Σ -L must be ranked higher than WSP, else that candidate would still be under consideration. As shown, both CVC and CVV reduplicative patterns are accounted for by the current ranking.

2.2.2. Analysis of CV Reduplication

In the following section, I extend this analysis to CV-reduplication. Unlike CVV and CVC-reduplication, the reduplicant surfaces as CV in CV-reduplication. As a starting point for this analysis, the following tableau illustrates the evaluation of *como* 'hill' under the current constraint ranking (for this tableau, I reintroduce *CC):

(33) Initial Analysis of CV Reduplication

/como. RED/	MAX _{IO-C}	AL- Σ -L	W S P	*C C	AL-RED- σ_{μ} -L	AL-RED-L	AL-Root-L	MAX _{IO}
a. (c \acute{o} -c.)mo							co	*!
b. (co.-c \acute{o} .)mo					*!		co	
c. (c \acute{o} .)-co.mo							co	
d. (c-co.mo)				*!				
e. (c \acute{o} m.)-co.mo							com!	

Tableau (33) shows that the current constraint ranking selects an incorrect optimal form. Candidate (a), which is the correct candidate, is eliminated by a violation of MAX_{IO}. Instead, candidate (c) is chosen with a long vowel reduplicant, similar to CVV and CVC-reduplication.

In order to eliminate candidates such as (33)(a), there must be a constraint that does not allow for a lengthened vowel in this instance. A crucial observation is that the vowel in the reduplicant that corresponds to the vowel in the input root does not have the same moraic structure. In candidate (33)(c), the reduplicant vowel has two moras, while the input root vowel has one mora. If it is crucial that corresponding input-reduplicant vowels have the same moraic structure, then candidate (33)(c) will be eliminated. Such a constraint can be regulated by a constraint of the IDENT schema of Correspondence Theory constraints (McCarthy & Prince 1995), indexed for moraic structure, and evaluated over input-reduplicant correspondence. Such a constraint is the following:

- (34) IDENT_{IR}[μ]
Corresponding input-reduplicant segments must have the same moraic structure.

This constraint eliminates candidates such as (33)(c).

However, it should be remembered that the reduplicant in CVC-reduplication is a long vowel, which is not the same structure as the input root monomoraic

vowel. But, CVC-reduplication candidates which preserve this structure violate *CC or WSP. Therefore, IDENT_{IR}[μ] must be ranked below *CC and WSP. The following tableau illustrates (for convenience, I eliminate ALIGN-RED-L and MAX_{IO}-C from the ranking, as they are not relevant):

(35) Evaluation of Hopi Reduplication

/como, RED/	AL- Σ-L	WSP	*CC	AL- RED- σ _μ -L	AL- Root -L	IDENT IR[μ]	MAX IO
☞ a. (c _ó -c.)mo					co		*
b. (co.-c _ó .)mo				*!	co		
c. (co _ó .)-co.mo					co	*!	
d. (c _{óm} .)-co.mo					com!		
/naqvi, RED/							
☞ e. (na _á .)-naq.vi		*			na	*	
f. (ná-nq.)vi			*!		na		*
g. (ná-n.)qvi			*!		na		*
h. (náq.)-naq.vi		*			naq!		
/saaqa, RED/							
☞ i. (sa _á .)-sa.qa					sa		*
j. (sa _á .)-saa.qa		*!					
k. (sá-s.)qa					sa	*!	**

Tableau (35) has three evaluations, one for each type of reduplication. In the CV-reduplication evaluation, the correct candidate (a) is chosen as optimal, as it preserves the moraic structure of the input root, unlike candidate (c). Candidate (b) (which also satisfies IDENT_{IR}[μ]) is eliminated by a fatal violation of ALIGN-RED-σ_μ-L, while candidate (d) incurs a fatal violation of ALIGN-Root-L.

In the CVC evaluation, the correct surface candidate (e) violates IDENT_{IR}[μ], but candidates (f), (g) and (h) show that attempts to satisfy IDENT_{IR}[μ] incur violations of either *CC or ALIGN-Root-L. In the CVV evaluation, the correct surface candidate (i) violates MAX_{IO}. The elimination of candidate (j) shows that an attempt to maintain faithfulness results in a violation of WSP. Candidate (k) is eliminated by the violation of IDENT_{IR}[μ].

3. Conclusion

In this paper, I have provided data illustrating Hopi nominal reduplication. These data show that the prosodic shape of the reduplicant is not consistent throughout the paradigm. This inconsistency is not adequately characterized if the shape of the reduplicant is limited by a prosodic templatic constraint. In some cases within a paradigm, the reduplicant does not match the same prosodic

shape as the other members of the paradigm, and must be accounted for by other constraints. However, if such options are available to the mismatched forms, they may be extended to the remaining paradigm, obviating the need for a templatic constraint to account for any of the reduplicated forms.

I have also shown that in some instances, the reduplicants are not circumscribed by a unique prosodic structure, but instead are sequences that compose part of a larger structure in the full reduplicated form. The analysis that I have proposed does not require a templatic constraint upon the reduplicant, and, therefore, this does not present a problem for an account of this reduplicative phenomenon. In the analysis provided, I have shown that all reduplicants within the paradigm can be accounted for without a templatic constraint.

4. Notes

¹ See Weinberg (1994) for a similar discussion of reduplication in Luiseño, a related language.

² The choice of leftward alignment over rightward alignment appears to be arbitrary at this point. The only requirement is that the edge be consistent among all such constraints of this type.

³ One may note that the stress appears on the second vowel of a long vowel. A more detailed analysis of the stress system of Hopi is beyond the scope of the present work. For the present analysis, it is only necessary to note that the stress appears on the heavy syllable.

5. References

- Hendricks, Sean. 1997. "Koasati punctual reduplication: morphemic fixed segments and phonological bases", Ms., University of Arizona.
- _____. forthcoming. "Bare consonant reduplication without reduplicative templates", Ms., University of Arizona.
- Jeanne, Laverne Masayesva. 1978. "Aspects of Hopi grammar", Ph.D. Dissertation, MIT.
- McCarthy, John J. and Alan Prince. 1986. "Prosodic morphology", Ms., University of Massachusetts, Amherst and Brandeis University, Waltham, Mass.
- _____. 1991. "Lectures on prosodic morphology", *Linguistic Society of America Summer Institute, University of California, Santa Cruz*.
- _____. 1993a. "Prosodic morphology I: constraint interaction and satisfaction", Ms., University of Massachusetts, Amherst, and Rutgers University, New Brunswick, N.J.
- _____. 1993b. "Generalized alignment", *Yearbook of Morphology 1993*: 79-154.
- _____. 1994. "The emergence of the unmarked: optimality in prosodic morphology", In Mercè González (ed.), *Proceedings of the North East Linguistic Society 24. Amherst, MA: Graduate Linguistic Student Association*: 333-379.

- _____. 1995. Faithfulness and reduplicative identity. In Jill Beckman, Laura Walsh Dickey, and Suzanne Urbanczyk (eds.), *University of Massachusetts Occasional Papers in Linguistics 18: Papers in Optimality Theory*. Amherst, MA: Graduate Linguistic Student Association: 249-384.
- _____. 1997. "Faithfulness and prosodic morphology". Ms., University of Massachusetts, Amherst, and Rutgers University.
- Prince, Alan and Paul Smolensky. 1992. "Optimality theory: constraint interaction in generative grammar". Paper presented at 12th West Coast Conference on Formal Linguistics, Los Angeles.
- Sekaqwaptewa, Emory. Personal Communication. University of Arizona.
- Walker, Rachel. "Minimizing RED: Nasal Copy in Mbe". To appear in *Proceedings of WCCFL XVII*, ed. by S. Blac, E.-S. Kim, and K. Shahin. Stanford, CSLI.
- Weinberg, Jessica. 1995. Paper presented at Linguistic Society of America: San Diego.

Everything you always Wanted to Know about Complementizer Agreement*

Eric Hoekstra & Caroline Smits
Meertens Institute, Amsterdam

1. Summary

This paper deals with characteristics of complementizer agreement in Dutch dialects (i.e. dialects spoken in the Netherlands and in the Dutch speaking region of Belgium).¹ In section 2, we will discuss a number of generalizations that have been made in relation to the phenomenon. In section 3 we will discuss a number of unsolved questions in relation to complementizer agreement:

- (i) Why do some dialects have complementizer agreement, others not?
- (ii) Why does complementizer agreement generally have a defective paradigm?

We propose (the beginning of) a solution to the second problem in section 4. In section 5, we will further modify the initial proposal.

2. Complementizer Agreement: Some Generalizations

2.1. What is complementizer agreement?

Complementizer agreement involves the phenomenon by which the agreement ending which appears on the verb also shows up on the complementizer, introducing a subordinate clause.² As a result, there is not only agreement between the subject and the verb as far as person and number are concerned, but between the subject and the complementizer as well (cf. also De Haan 1997). Although this phenomenon is highly uncommon in the languages of the world, it is quite popular in German and Dutch dialects. Both German and Dutch are Verb-Second languages, and this seems to be a necessary condition for complementizer agreement to occur. As said, the present paper only discusses the phenomenon in the Dutch dialects. Consider the following examples of complementizer agreement:

- (1) Limburg:
veurtot-s tiech de bruk zuu-s
before-2SG you the bridge see-2SG

- (2) South Holland:
 datt-e ze ziek benn-e
 that-3PL they ill are-3PL

2.2. The copy generalization: the agreement ending on the verb in the sentence in question is copied onto the complementizer.

In early studies dealing with complementizer agreement, the stand is taken that the agreement ending of the verb in the sentence in question is simply copied onto the complementizer. This view is reflected by **Beckerling Vinckers (1872)**, for instance, who, in an attempt to explain the phenomenon, **claimed** that the so-called 'conjugated conjunctions' are actually slips of the tongue; a speaker who is uttering a sentence may anticipate the end of that sentence - that is the finite verb -, and may thus prematurely add the agreement ending of the verb to the conjunction. **Beckerling Vinckers'** explanation of the phenomenon cannot be correct, however, since it completely ignores the systematic nature of the phenomenon: it is only agreement endings that re-appear (and never the markers for tense); these endings only occur on the complementizer (and never on other parts of the sentence, for instance on the subject or the object); moreover, and as will be discussed in greater detail below, complementizer agreement is generally limited to specific forms within the paradigm. To give two examples of the latter: in Frisian, complementizer agreement only occurs in clauses with 2SG subjects; in Limburg dialects, it only occurs in 2SG and 2PL.

Similarly, **Van Haeringen (1939)** explains the phenomenon by stating that it occurs in an attempt to overcome the distance between subject and finite verb, a distance which can be quite long in subordinate clauses in Dutch. By copying the agreement ending of the clause-final verb onto the clause-initial complementizer, the tension between subject and finite verb is somewhat relieved. Again, this view reflects the idea that the agreement ending of the finite verb in the sentence in question is simply copied onto the complementizer, meaning that the agreement endings occurring on the verb and on the complementizer should be identical. Cf. the following examples which seem to be in harmony with this view ('MP' stands for 'modal particle'):³

- (3) North Holland:
 azz-e je morgenavond even ankomm-e
 when-2SG you tomorrow evening MP come-2SGover
- (4) North Holland/South Holland:
 toen-e me kwamm-e
 when-IPL we came-IPL

- (5) North Holland/South Holland:
 (ze zegge) datt-e ze ziek benn-e
 (they say) that-3PL they sick are-3PL
- (6) Flanders (Belgium):
 (et werk) da-n de kinders gemaakt e-n
 (the work) that-3PL the children made have-3PL
- (7) Groningen:
 (ik wait nait) of-s toe kom-s
 (I know not) if-2SG you (2SG) come-2SG
- (8) Groningen:
 az-n koin nait in et laand blievm will-n
 when-3PL cows (3PL) not in the land stay want-3PL
- (9) Overijssel (Enschede):
 (ik weet nig) of-s toe kom-s
 (I know not) if-2SG you (2SG) come-2SG
- (10) Limburg:
 (iech waet neet) boe-t ger zee-t
 (I know not) where-2PL you (2PL) are-2PL

2.3. The inversion generalization: the ending on the complementizer is identical to the agreement ending on the verb in inversion

As becomes clear from the endings on the complementizer in dialects spoken in the eastern parts of the Netherlands, however, the copy generalization, discussed above, cannot be correct. It concerns a vast area (i.e. large parts of the Provinces of Drente, Overijssel and Gelderland) that have a 123PL ending -*t* (cf. Hol 1955). Cf. in this light the following examples, taken from Van Haeringen (1958):

- (11) ik geleuve datt-e wy et mit hum maar es prebeer-t
 I believe that-I PL we it with him MP MP try- I PL
- (12) azz-e wy de turf niet verkoopn kun-t
 if-IPL we the peat not sell can-IPL

In the eastern dialects in question, complementizer agreement only occurs in 1PL. Obviously, in these dialects the agreement ending of the verb, ending in -*t* (*prebeer-t* and *kun-t* in (11) and (12) above), is not identical to the ending on

the complementizer, which ends in *-e* (*datt-e* and *azz-e* in (II) and (12) above). This means that complementizer agreement does not simply entail the phenomenon by which the agreement ending of the verb in the sentence in question is copied onto the complementizer. As Van Haeringen (1958) rightly noted, it is actually the agreement ending of the verb in inversion (which is the verb form in *absentia*) which is added to the complementizer. Naturally, this can only be observed by considering dialects in which the agreement ending of the verb in inverted order is different from the ending in non-inverted order. The eastern dialects from which the examples in (11) and (12) are taken represent such dialects. In these dialects the IPL verb ending in non-inverted order is different from the IPL verb form in inverted order; in inverted order it ends in *-e*, and in non-inverted order it ends in *-t*. Cf. (13):

- (13) a. wy speul-t
 we play-IPL
 b. speul-e wy
 play-IPL we

In short, the ending which is added to the complementizer is identical to the agreement ending of the finite verb in inversion. For the eastern dialects under discussion this means that in clauses with a IPL subject the complementizer ends in *-e*, hence *datt-el*dat-t* and *azz-el*as-t*.

3. Unsolved Mysteries in Relation to Complementizer Agreement

The above inversion generalization does not exhaustively characterize complementizer agreement, however. Actually, there are quite a number of unsolved mysteries in relation to the phenomenon. One of these mysteries concerns the geographical distribution of complementizer agreement within the Dutch speaking area, another concerns the distribution within the paradigm of verbal endings.

3.1. Defective geographical distribution

Remarkably enough, complementizer agreement does not occur within all regions or dialects within the Dutch area (i.e. the Netherlands and Dutch speaking Belgium). Put differently, although Verb-Second seems to be a necessary condition for complementizer agreement to take place, and although all Dutch dialects meet this condition, the phenomenon does not occur throughout the Dutch speaking area.

First, we should distinguish between a western part and an eastern part where

complementizer agreement does occur, and an area in between where the phenomenon is absent. The latter area involves the Dutch Provinces of Utrecht, North Brabant, and a large part of the Province of Gelderland, and the Belgian Provinces of Antwerp and Brabant.

Second, the western and the eastern part where complementizer agreement does occur can be further subdivided. As far as the western part of the area is concerned, a northern part and a southern part can be distinguished where complementizer agreement does occur. The northern part involves the dialects spoken in the Provinces of North Holland and South Holland (Van Haeringen 1939). The southern part involves the isles of Zuid-Beveland (Hoekstra 1993) and Zeeuws-Vlaanderen (De Visser & Goeman 1979) in the Province of Zeeland, the Flemish dialects in the Province of French Flanders, West Flanders, and the eastern part of East Flanders (Vanacker 1949; De Schutter 1997). Between the northern and the southern part, however, there is a region where complementizer agreement is absent. This involves the isles of Goeree-Overflakkee (in the Province of South Holland), and Schouwen-Duiveland and Noord-Beveland (in the Province of Zeeland).

Similarly, the eastern part of the Dutch speaking area can be divided into two areas where complementizer agreement does occur, and an area in between where it is absent. Specifically, both the northern and the southern part do have complementizer agreement: the northern part concerns the Provinces of Friesland, Groningen, and the eastern parts of the Provinces of Drenthe, Overijssel and Gelderland (Beckering Vinckers 1872; Klatter 1933; Van Ginneken 1939; Van Haeringen 1958; Van der Meer 1991; De Haan 1997); the southern part concerns the Province of Limburg, particularly the southern region (Van Ginneken 1939). Between these two parts, however, there is, again, an area where complementizer agreement is absent. At present, we do not have a ready explanation for the remarkable distribution of complementizer agreement throughout the Dutch-speaking area.

3.2 Defective paradigmatic distribution

Perhaps even more remarkable is the fact that in the areas and dialects in which complementizer agreement does occur, it is rarely the full paradigm of verbal endings (123SG and 123PL) which appears on the complementizer. Put differently, complementizer agreement generally has a defective paradigm.⁴ Moreover, it appears that different dialects exhibit different preferences for specific forms within the paradigm.⁵ Cf. the following list of complementizer agreement in various Dutch dialects (cf. also the examples under (1)-(12) that were given above):

- | | |
|---------------------|--------------------|
| (14) North Holland: | 2SG -e + 123PL -e |
| South Holland: | 123PL -e |
| Zeeland Flanders: | I SG -n + 123PL -n |

Friesland:	2SG -st
Groningen:	2SG -st + 123PL -n
Overijssel:	2SG -s
Eastern dialects:	1PL -e
Limburg	2SG -s + 2PL -t

In sum, we can ask ourselves at least the following two questions:

- (i) Is there a system in the defectivity of the paradigms for complementizer agreement?
- (ii) Why do some dialects have complementizer agreement, others not?

3.3 Comparing complementizer agreement with verb agreement

In some sense, complementizer agreement seems to be parasitic on verb agreement. We find dialects with verb agreement but without complementizer agreement. However, we do not find dialects with complementizer agreement but without verb agreement.

Verb agreement in West-Germanic can be either synthetic or analytic. Consider the ending in the following paradigm:

(15) Main verb *lopen* 'to run'

	present	past
1S	loop	liep
2S	loopt	liep
3S	loopt	liep
PL	lope	liepe (official PL spelling: -en)

The *-t* encodes person/number information, on the one hand, and tense information, on the other. Thus the *-t* says: you're dealing with a singular form, second or third person, and you're dealing with a present tense form. As the *-t* encodes both person/number information and tense information, it is commonly referred to as a synthetic ending. The plural ending, on the other hand, does not encode tense information. It just says: you are dealing with a plural. Hence it is an analytic inflection.

Thus verbal agreement can be either synthetic or analytic. Does complementizer agreement have all the properties of verb agreement? No, it does not. In order to come to grips with the remarkable paradigmatic distribution of complementizer agreement it is important to stress the fact that the agreement between the complementizer and the verb always involves person and number, never tense (cf. already Van Haeringen 1958). Put differently, complementizer agreement never depends on marking for tense, but on marking for person and number only. The net result is that the agreement ending that is added to the complementizer is the same in both present tense sentences and preterite sentences.

By taking the latter fact as a starting-point, we will propose a new generalization which may bring us to a closer understanding of the fact that complementizer agreement generally has a defective paradigm. We will elaborate upon this proposal in the following section.

4. A New Generalization

Just like the verb, the complementizer agrees with the subject. A close inspection of complementizer agreement and verb agreement yields an astonishing result. It turns out that the agreement ending that is added to the complementizer is the same in clauses in the present tense and clauses in the past tense. Put differently, the ending added to the complementizer agrees with both the agreement ending of the present tense verb and the preterite verb. This means that the complementizer never expresses tense information. Therefore, complementizer agreement is never synthetic.

This leads us to the following two conditions on complementizer agreement:

- (16) The PNT condition Complementizer agreement can be agreement for Person and Number but it may not express Tense
- (17) The homophony condition
Complementizer agreement must be homophonous to verbal agreement

The corollary of these two conditions is the following generalization.

- (18) The identity generalization (to be revised)
Complementizer agreement only occurs when the agreement ending of the inverted verb in the present tense is identical to the agreement ending of the inverted verb in the preterite

This generalization explains the defectiveness of the paradigms of dialects with complementizer agreement that have been discussed in the previous sections. In Frisian, for instance, the agreement ending for 2SG is identical in the present tense and the preterite (*-st*). As expected, Frisian has complementizer agreement in 2SG. However, the agreement ending in 123PL is not identical in the present (*-e*) and in the preterite (*-n*). As expected, Frisian has no complementizer agreement in the plural.

In the Groningen area, however, the ending for 123PL in present tense and preterite verbs is identical (*-n*). Indeed, different from Frisian, the Groningen dialects do have complementizer agreement in the plural.

In the eastern dialects that have complementizer agreement in 1PL (cf. section 2.3: *wy speult* 'we play' but *speule wy* 'play we', hence *datte wy* 'that we') we expect, on the basis of the condition above, that the agreement ending reads *-e*

in preterite 1PL, and this is indeed the case. Cf. the following examples taken from Van Haeringen (1958):

- (19) a. speul-e wy 'play we' (present 1PL)
 b. bet-e wy 'bit we' (preterite 1PL)

In 3PL,⁶ however, the present tense ending is not identical to the preterite ending. Cf. the following examples (Van Haeringen 1958):

- (20) a. speul-t ze 'play they' (present 3PL)
 b. beet-n ze 'bit they' (preterite 3PL)

Hence, in 3PL complementizer agreement is absent in the dialects in question. All in all, the generalization formulated under (18) explains the defective paradigms of the dialects that have been discussed in the present paper. Cf. the table below that sums up the facts:

Table 1: Verb agreement and complementizer agreement in Dutch dialects.

REGION	PRESENT	PAST	COMP AGREEMENT?
North Holland			
2SG	-e	-e	yes
3SG	-t	∅	no
123PL	-e	-e	yes
South Holland			
3SG	-t	∅	no
123PL	-e	-e	yes
Zeeland Flanders			
1SG	-n	-n	yes
123PL	-n	-n	yes
Friesland			
2SG	-st	-st	yes
3SG	-t	∅	no
123PL	-e	-n	no
Groningen			
2SG	-st	-st	yes
3SG	-t	∅	no
123PL	-n	-n	yes
Overijssel			
3SG	-t	∅	no
1PL	-e	-e	yes
3PL	-t	-n	no
Limburg			
2SG	-s	-s	yes
3SG	-t	∅	no
2PL	-t	-t	yes

The data on complementizer agreement that we have at our disposal at present appear to corroborate our hypothesis that complementizer agreement only occurs if the agreement ending of the present tense verb is identical to the agreement ending of the preterite verb (in inversion).

Zero agreement also provides evidence for or against our account, of course. Although it is logically possible that a dialect does not have verb agreement, whereas it does have complementizer agreement, we predict that if verb agreement in inversion is zero, then complementizer agreement must also be zero. In all dialects discussed above, the predictions concerning zero agreement are borne out.

5. Sharpening up the Identity Generalization

We have claimed that the agreement ending of the complementizer must be homophonous with the agreement ending of the verb. But verbs constitute a large class. It is hardly conceivable that a grammatical condition checks on all members of the class of verbs. It is far more likely that only a characteristic closed subset of all verbs is concerned. Hence we suggest the following revision of the homophony condition:

- (21) The identity generalization (revised)
 Complementizer agreement only occurs when the agreement ending of the inverted auxiliary in the present tense is identical to the agreement ending of the inverted auxiliary in the preterite

We will now go on to provide two pieces of evidence for the identity generalization, as restricted to auxiliaries.

1. Limburg facts support the claim that the auxiliaries are relevant, and not just all verbs. In the Limburg dialect of Maastricht, the 2PL verb forms end in *-t* as far as present tense verbs and irregular past tense verbs (this includes all auxiliaries) are concerned. However, the 2PL of regular past tense verbs does not end in *-t*, but in \emptyset :

- (22) Present tense irregular (hence all auxiliaries):
 a. kin-t ger 'can you'
 b. * kin ger
- (23) Present tense regular:
 a. woen-t ger 'live you'
 b. * woen ger

- (24) Past tense irregular (hence all auxiliaries):
 a. waor-t ger 'were you'
 b. * waor ger
- (25) Past tense regular:
 a. woende-t ger 'lived you'
 b. * woende ger

Notwithstanding the fact that the 2PL agreement ending *-t* is absent on regular past tense verbs, complementizer agreement does occur in 2PL in Limburg dialects, thanks to the fact that it occurs on irregular preterite verbs (among which auxiliaries). This supports the final version of the identity generalization.

2. Facts from Standard Dutch provide a second piece of evidence for the proposed revision of the identity generalization. Standard Dutch does not have complementizer agreement, notwithstanding the fact that present tense and preterite plural verbs generally end in *-e*. However, an important subset of the auxiliaries violates the identity generalisation.⁷ This involves the so-called monosyllabic *-n* verbs, such as *zijn* 'to be', *gaan* 'to go' and *doen* 'to do'. Instead of the usual *-e* plural, these verbs feature an *-n* in the present tense plural. The revised identity generalization correctly predicts that complementizer agreement does not occur in Standard Dutch: the agreement ending of the present tense auxiliary (in *-n*) is not identical to the agreement ending of the past tense auxiliary (in *-e*). Consequently, complementizer agreement does not occur.

Table 2: Verb agreement and complementizer agreement in Standard Dutch.

STANDARD DUTCH	PRESENT	PAST	COMP AGREEMENT ?
Monosyll.aux., 123PL	-n	-e	no

This is the reverse case of the Limburg case. In Standard Dutch, the auxiliaries and only the auxiliaries block complementizer agreement.

Notice that we capitalize on the fact that all auxiliaries are strong verbs. Of course, we could also restrict the identity generalization to strong verbs. However, the notion 'strong verb' seems to us a less basic notion than 'auxiliary'. There are several reasons for this. The notion 'strong verb' is restricted to Indo-European, the notion 'auxiliary' is presumably relevant to all languages of the world. Furthermore, there is no relation between the notion 'strong verb' and the notion 'complementizer'. However, there *is* a relation between the

notion I auxiliary' and the notion 'complementizer' (Paardekooper 196 1). We could even go one step further and suppose that not all auxiliaries but only one is relevant, for example, the verb *zijn* 'be'. We will leave this for future research.

6. Notes

* We would like to thank the audience at the Meertens Institute Symposium 1994 on Complementizer Agreement and the audience at the Western Conference on Linguistics 1998 for stimulating questions and discussion.

1. This article is a revised version of Hoekstra & Smits (1997).
2. Never co-ordinate clauses.
3. The examples were taken from Van Ginneken (1939), Van Haeringen (1939, 1958), De Vries (1940), and from a corpus of spoken Maastricht (Province of Limburg) gathered in 1997.
4. However, for a number of Flemish dialects it is claimed that complementizer agreement is applied throughout the paradigm (cf. e.g. Haegeman 1992; De Schutter 1997).
5. Note, by the way, that another distinction should be made. This involves the fact that within some areas complementizer agreement is optional, whereas in other areas it is obligatory. Specifically, complementizer agreement is generally optional, the only two exceptions being Frisian (2SG) and the Limburg dialects (in 2SG; in 2PL it seems to be optional). We will not deal with the problem of the optionality of complementizer agreement here.
6. At present, we do not have any data at our disposal concerning the agreement ending for preterite verbs in 2PL in the eastern dialects in question.
7. The absence of complementizer agreement in Standard Dutch may not only be attributed to structural factors, but to cultural factors as well. Specifically, it is claimed that due to the strong normativeness of standard languages, natural processes such as complementizer agreement develop far less easy in such languages than in dialects (which are generally far less normative) (cf. Van Marle 1997).

7. References

- Beckerling Vinckers, J. 1872. 'Phonctische voorbarigheid, een middel ter verklaring van smiins'. *Taal en Letterbode*:165-171.
- Ginneken, J. van. 1939. 'De vervoeging der onderschikkende voegwoorden en voornaamwoorden'. *Onze Taaltuin* 8: 1-11.
- Haan, G. de. 1997. 'Voegwoordcongruentie in het Fries'. *Vervoegde voegwoorden*, ed. by E. Hoekstra & C. Smits. Amsterdam: P.J.Meertens-

- Instituut, 50-67.
- Haegeman, L. 1992. *Theory and Description in Generative Syntax. A Case Study in West Flemish*. Cambridge: University Press.
- Haeringen, C.B. van. 1939. 'Congruerende voegwoorden'. Reprinted in Van Haeringen (1962), *Neerlandica. Verspreide opstellen*. The Hague: Daamen, 246-259.
- Haeringen, C.B. van. 1958. 'Vervoege voegwoorden in het oosten'. Reprinted in Van Haeringen (1979), *Gramarie*. Utrecht: HES, 309-318.
- Hoestra, E. 1993. 'Some implications of number agreement on COMP'. *Linguistics in the Netherlands 1993*, ed. by F. Drijkoningen & K. Hengeveld. Amsterdam: Benjamins, 61-68.
- Hoekstra, E. & C. Smits. 1997. 'Vervoege voegwoorden in de Nederlandse dialecten'. *Vervoege voegwoorden*, ed. by E. Hoekstra & C. Smits. Amsterdam: P.J. Meertens-Instituut, 6-29.
- Hol, A.R. 1955. 'Het meervoud van her praesens in onze oostelijke dialecten', *Taal en Tongval* 7: 160-175.
- Klatter, J. 1933. 'Dialectstudie en syntaxis', *Onze Taaltuin* 2: 73-84.
- Marle, J. van. 1997. 'Dialect versus standard language: nature versus culture', *Taming the Vernacular. From Dialect to Written Standard Language*, ed. by J. Cheshire & D. Stein. London: Longman, 13-34.
- Meer, G. van der. 1991. 'The 'conjugation' of subclause introducers: Frisian -st', *NOWELE* 17: 63-84.
- Paardekooper, P.C. 1961. 'Persoonsvorm en voegwoord', *De Nieuwe Taalgids* 54: 296-301.
- Schutter, G. de. 1997. 'Incorporatie-in-C in de Vlaamse en de Brabantse dialecten'. *Vervoege voegwoorden*, ed. by E. Hoekstra & C. Smits. Amsterdam: P.J. Meertens-Instituut, 31-49.
- Vanacker, F. 1949. 'Over enkele meervoudsvormen van voegwoorden', *Taal en Tongval* 1: 32-45, 77-93, 108-112.
- Visser, M. de & A. Goeman. 1979. 'Voegwoord, relatief partikel en persoonsvorm in een dialect. Een geval van schijnbare kongruentie bij voegwoorden in de 1e persoon enkelvoud', *Taal en Tongval* 31: 222-241.
- Vries, W. de. 1940. 'Congruerende voegwoorden', *Tijdschrift voor Nederlandse Taalen Letterkunde* 59: 78-79.

Eric Hoekstra &
 Caroline Smits Meertens Institute
 PO Box 94264 1090 GG
 Amsterdam e - m a i l :
 Eric.Hoekstra@Meertens.knaw.n
 l
 Caroline.Smits@Meertens.knaw.
 nl

Case-marking and Topicality in the Korean Causative Construction

Jong-Bai Hwang
University of Oregon

1. Introduction

The lexical causative construction in Korean, which is represented by several causative morphemes attached to verb stems, shows an alternation of case markers for the causee or the complement subject according to whether the embedded sentence is intransitive or transitive. That is, when intransitive sentences are embedded, the complement subject, or the manipulee, takes the accusative case marker, while when transitive sentences are embedded, the manipulee takes the dative case marker and the complement object takes the accusative marker instead:

- (1) a. ku-ka aki-lul kkay-wu-et-ta
 he-NOM baby-ACC wake-CAUS-PAST-DECL
 ‘He woke the baby up (= He had the baby wake up).’
 b. ku-ka motwu-eykey cim-ul ci-wu-et-ta
 he-NOM everyone-DAT burden-ACC carry-CAUS-PAST-DECL
 ‘He had everyone carry the burden.’

The choice of case markers for the complement subject in the above causative sentences can be predicted by Comrie’s (1976) case hierarchy in terms of transitivity as follows:

- (2) Comrie’s case-bumping hierarchy

If the accusative slot is already occupied, e.g., when the causative operation is applied to a transitive verb with a direct object, then the manipulee of the causative construction will be assigned the next available case on the hierarchy ACC > DAT > AGT.

The complement subject of an intransitive verb in (1a) takes the accusative case marker *-lul*, which is predicted by Comrie’s hierarchy, because the accusative slot is not already occupied. However, in the sentence of (1b), where the verb in the complement clauses is transitive, the complement subject takes the dative case marker *-eykey*, which is also predicted by Comrie’s hierarchy. Since the accusative slot is already occupied by the direct object of the complement clauses, the complement subject is assigned the next available case in the hierarchy, that is, the dative case.

However, Comrie's prediction on the case-marking of the manipulee in terms of transitivity of the complement verb does not seem to be relevant for the following sentences, which show an alternation of case markers between dative and accusative for the complement subject. The alternation results in two accusative slots in one sentence, one for the object of the complement clause and the other for the subject of the complement clause, as in (3b) and (4b):

- (3) a. Younghee-ka tongsaying-**eygey** pap-ul mek-i-et-ta
 Younghee-NOM brother-**DAT** rice-ACC eat-CAUS-PAST-DECL
 'Younghee fed her brother. (= Younghee had her brother eat rice.)'
 b. Younghee-ka tongsaying-**ul** pap-ul mek-i-et-ta
 Younghee-NOM brother-**ACC** rice-ACC eat-CAUS-PAST-DECL
 'Younghee fed her brother. (= Younghee had her brother eat rice.)'
- (4) a. ku-ka motwu-**eygey** cim-ul ci-wu-et-ta
 he-NOM everyone-**DAT** burden-ACC carry-CAUS-PAST-DECL
 'He had everyone carry the burden.'
 b. ku-ka motwu-**lul** cim-ul ci-wu-et-ta
 he-NOM everyone-**ACC** burden-ACC carry-CAUS-PAST-DECL
 'He had everyone carry the burden.'

The sentences in (3a) and (4a) have two different case markers for the complement subject and object respectively, which fits well in Comrie's hierarchy. However, even if the accusative slots are occupied with the accusative case of the complement clause in (3b) and (4b), another accusative slot is inserted, resulting in two accusative slots in one sentence. Comrie's hierarchy seems to fail to account for the cases at all.

How then can we account for the problem? Should we propose another hypothesis that can explain the case involving two accusative slots? Otherwise, is there any other way to account for those sentences? This paper tries to explain the problem in terms of object incorporation, and to examine the topicality of the incorporated object in Korean narrative discourse.

2. Object Incorporation in Korean

In addition to the double-accusative case in the causative construction, Korean also shows the same case of double accusative markers in the simple clause where the indirect object takes both the accusative case marker *-(l)ul* and the dative marker *-eykey*:

- (5) a. nwuna-ka tongsayng-**eykey** kwaca-lul cwu-n-ta
 sister-NOM brother-**DAT** cookie-ACC give-PRES-DECL
 'The sister gives her brother cookies.'

- b. *nwuna-ka tongsayng-ul kwaca-lul cwu-n-ta*
 sister-NOM brother-ACC cookie-ACC give-PRES-DECL
 'The sister gives her brother cookies.'

It is more natural that the indirect object of the verb like *cwu (-ta)* 'give' which usually takes two objects, an animate indirect object and an inanimate direct object, takes the dative case marker *-eykey* like in (5a). However, the sentence in which the indirect object takes the accusative marker like in (5b) is still acceptable and grammatical in Korean, though it seems to violate the principle of case hierarchy.

Several studies on the double accusative case markers in Korean have argued that the alternation between the accusative and dative case markers for the indirect object is arbitrary (K. H. Kim, 1984; Shibatani, 1976; Yang, 1987). In other words, the dative case marker *-eykey* is just replaced with the accusative case marker *-(l)ul* with no semantic or pragmatic change. However, Y. S. Kim (1979) explains the use of the different case markers by suggesting different verbal structures. Kim argues that the original direct object *kwaca* 'cookie' in (5b) is incorporated with the original verb *cwu-ta* 'give' to form a new incorporated verbal unit, so that the incorporated verb takes the new direct, not the indirect, object, *tongsaying* 'brother'. That's why the original indirect object *tongsaying* 'brother' takes the accusative case marker, not the dative case marker. Kim cites the following pairs of conversation to support his argument for the incorporated verbal structure:

- (6) A: *nwuna-ga tongsaying-ul echi ha-nu-nya?*
 Sister-NOM brother-ACC how do-PRES-QUES
 'What is the sister doing to her brother?'
 (7) a. B: *miwueha-n-ta.*
 hate-PRES-DECL
 '(She) hates (him).'
 b. B: *simbwurum siki-n-ta*
 errand do-PRES-DECL
 '(She) is sending (him) on an errand.'
 c. B: *kwaca (-lul) cwu-n-ta*
 cookie (-ACC) give-PRES-DECL
 '(She) gives (him) cookies.'

Not only the simple verb like (7a) but also the incorporated verb like (7b, c) is possible as a reply to a question like (6). Kim argues that the use of the incorporated verb like (7b, c) in the same way as the simple predicate like (7a) may support the hypothesis on the reorganization of the verbal structure by the incorporation of the object into the verb.

The alternation of the two case markers for the complement subject of the Korean causative construction may have something to do with the process of

incorporation, too. The following sentences in (8) show the explicit incorporation of the complement object into the verb. The complement object in the causative sentence can sometimes lose its accusative marker and then it is incorporated into the verb to yield a combined single verbal structure. In this case of object incorporation, the complement subject, or the causee, takes the accusative case marker, not the dative case marker. That is, the alternation of the two case markers does not occur any longer if the direct object or the complement object is incorporated into the verbal structure with its accusative case marker trimmed:

- (8) a. Younghee-ka tongsaying-**ul** pap mek-i-et-ta
 Younghee-NOM brother-**ACC** rice- ϕ eat-CAUS-PAST-DECL
 ‘Younghee fed her brother. (= Younghee had her brother eat rice.)’
 b. ?*Younghee-ka tongsaying-**eygey** pap mek-i-et-ta
 Younghee-NOM brother-**DAT** rice- ϕ eat-CAUS-PAST-DECL
 ‘Younghee fed her brother. (= Younghee had her brother eat rice.)’

The sentence in (8a) has an incorporated verb resulting from depriving the complement object of the accusative marker *-(l)ul*, and instead attaching the accusative marker to the complement subject. The resultant sentence has a single accusative sentence with only one accusative marker attached to the human causee of the complement clause.

Considering the object incorporation and the use of the case markers, this paper hypothesizes that sentences with two accusative case markers involve the process of the incorporation of the complement object into the verb, resulting in the change of sentence structure. In other words, the causative constructions with the transitive complement clause comes to have double accusative case markers as a result of the incorporation of the complement object into the verb. The present study will address the assumption

3. Incorporation and Topicality

Object incorporation into the verb is believed to have much to do with the topicality of the object. Object incorporation is a process via which the importance/saliency of direct objects that are semantically prototypical patients is toned down or ‘suppressed’ (Givón, 1984: 108). According to Givón, it is most typical that a non-referential object, that is, one whose individual identity does not matter for the purpose of the communication, is trimmed of most of its characteristic inflectional morphology and then incorporated into the verb stem to yield a combined single verbal word. The Korean sentence in (8a) before is a good example of the process of object incorporation.

Park (1990) tries to explain the use of the accusative case marker with respect to the topicality of the referent which takes the case marker. He argues that the pragmatic function of the accusative case marker *-(l)ul* in Korean is to represent high topicality of the patient. Therefore, the use of the accusative marker *-(l)ul* for the indirect object is related to the transitivity or topicality upgrading of the indirect object, and at the same time, it affects of the topicality of the original direct object, resulting in the downgrading of the topicality.

The present study will explore the cause of such mental incorporation through the text study of Korean narrative discourse. It is expected that the text study will reveal the difference of topicality between the three types of causative constructions with different case marker pairs: DAT (for indirect object)-ACC (for direct object), double accusatives (ACC-ACC), and incorporated objective (ACC- ϕ).

4. Hypotheses

This study compares the topicality of the complement object and subject between the following three related structures:

(9) a. DAT-ACC

emma-ka Younghee-**eygey** pap-ul mek-i-et-ta
 Mom-NOM Younghee-**DAT** rice-**ACC** eat-CAUS-PAST-DECL
 'Mom had Younghee eat rice.'

b. Double ACC

emma-ka Younghee-**lul** pap-**ul** mek-i-et-ta
 Mom-NOM Younghee-**ACC** rice-**ACC** eat-CAUS-PAST-DECL
 'Mom had Younghee eat rice.'

c. Incorporated Object

emma-ka Younghee-**lul** pap mek-i-et-ta
 Mom-NOM Younghee-**ACC** rice eat-CAUS-PAST-DECL
 'Mom had Younghee eat rice.'

The three sentences in (9) are thought to differ in their degree of the incorporation of the complement object into the verbs. That is, the sentence in (9a) has two objects, indirect and direct, which are not incorporated into the verb at all, while the sentence in (9c) shows the full incorporation of the complement object *pap* "rice" into the verb with the accusative case marker trimmed. The sentence in (9b) has a certain degree of incorporation which the use of the accusative marker *-lul* for the indirect object reveals, although the accusative marker is also attached to the direct object.

Incorporation has something to do with the downgrading of the topicality of the incorporated object. Then, the topicality of the complement object or the incorporated object is expected to show the same order as Hypothesis 1, which is the first hypothesis of the study:

Hypothesis 1: The topicality of the complement object (or the incorporated object) will show the following order: DAT-ACC > Double ACC > Incorporated Object.

Besides the topicality of the complement object or the incorporated object, this study is also interested in the topicality of the complement subject or the causee. That is, if the accusative case marker is related to the function of topicality upgrading, the topicality of the complement subject is expected to show the reverse order of the topicality of the complement object.

Hypothesis 2: The topicality of the complement subject (or the manipulee) will show the following order: DAT-ACC < Double ACC < Incorporated Object.

5. Text Study

5.1. Topicality Assessment

To measure the topicality of the complement subject or object in the Korean causative constructions, the quantitative text-based method developed by Givón (1983) was used (Givón, 1994; Wright and Givón, 1987). Generally speaking, it is assumed that more topical (or thematically important) referents tend to be more persistent cataphorically. The cataphoric persistence can be assessed by measuring topic persistence (TP): the number of times the referent recurs within the next 10 clauses following its present occurrence. TP values between 0 and 10 are most commonly recorded. The TP measure has proven to be particularly useful in assessing the topicality of nominal referents regardless of anaphoric antecedence (Wright and Givón, 1987). In general, more topical (i.e., thematically important) referents tend to have TP values >2, while less topical referents have values of 0-2.

5.2. Material

In order to guarantee cataphoric repetition or non-repetition of the referents in the target structures, this study adopts an experimental method which has the subjects continue incomplete narratives (Wright, 1989). Several informal narratives in Korean were auditorily presented to Korean native speakers. The subjects were told that at some point in each narrative it would stop. Then it

was the subjects' task to continue the narrative. The narratives were created so that the last clause of each contained one of the target structures.

Twelve experimental and eight filler narratives were constructed. All the narratives were written in a very informal, conversational dialect. The 20 narratives were randomly ordered. The last sentences in the experimental narratives were supposed to contain the target structures which resembled each other closely. Filler narratives were inserted to camouflage the nature of the experimental sentences.

The narratives were recorded and given to 20 native Korean speakers. The subjects were told to listen to the beginnings of 20 stories and to complete them as they felt the narrator of the stories would have done. At the end of each narrative, the subjects were given 40 seconds to tell their continuation. After 40 seconds, the subjects heard one single tone. If they had not finished their continuation, they were instructed to take 20 more seconds to finish it. After 20 seconds, they heard three consecutive tones to signal them to stop. After the tone, the subjects were given a 20 second break before the next narrative began. To get accustomed to the experimental task, the subjects were given two trial narratives before the experiment began. The subjects' narrative continuation was recorded and analyzed for further analyses of topic persistence.

5.3. Results

Twenty subjects produced a total of 240 narratives of the target structures. It means that 80 different stories were made for each target structure. The topicality of the complement object and subject were determined by counting and comparing the number of the narratives which have low or high TP values, out of the total 80 narratives of each type of structure.

Table 1 summarizes the distribution of low (0-2) and high (>2) topic persistence (TP) values for the complement object in the three types of causative structures.

Table 1
Distribution of topic persistence values for the complement object in the three constructions

Structures	Low TP	High TP
DAT-ACC	45 (56.25%)	35 (43.75%)
Double ACC	64 (80%)	16 (20%)
Incorporated	78 (97.5%)	2 (2.5%)

Overall, the topicality of the complement object in each structure is rather low. In all of the three target structures, more than 50% of the narratives are in the low topicality range: 56.25% for DAT-ACC, 80% for Double ACC, and 97.5% for Incorporated. However, the difference between them seems to be significant. That is, even if the overall topicality of the complement object is low, the topicality seems to differ between the target structures. Planned comparisons of chi-square between DAT-ACC and Double ACC, and between Double ACC and Incorporated confirmed the difference: $\chi^2 = 10.39$, $p = .001$ between DAT-ACC and Double ACC; $\chi^2 = 12.27$, $p = .0001$ between Double ACC and Incorporated. Furthermore, the original object in the incorporated object sentence hardly shows any topicality (just 2.5% of high TP), which implies the full incorporation of the object into the verb. The complement object with accusative case marker shows increased topicality. In particular, the complement object of the DAT-ACC construction shows the highest topicality, and that of the double accusative construction is in-between.

On the other hand, Table 2 summarizes the distribution of low and high topic persistence (TP) values for the complement subject in the three types of causative structures.

Table 2

Distribution of topic persistence values for the complement subject in the three constructions

Structures	Low TP	High TP
DAT-ACC	33 (41.25%)	47 (58.75%)
Double ACC	29 (36.25%)	51 (63.75%)
Incorporated	21 (26.25%)	59 (73.75%)

The topicality of the complement subject in each construction is rather high. All of the three target structures have a rather high topicality range of more than 50%: 56.25% for DAT-ACC, 80% for Double ACC, and 97.5% for Incorporated. However, the differences between them are not significant. That is, even if the overall topicality of the complement object is rather high, the TP value shows insignificant differences between the target structures: $\chi^2 = 4.13$, $p = .13$. Though the topicality range increases from the DAT-ACC construction to the incorporated object construction, it does not necessarily mean that the topicality of the complement subject in the incorporated construction is higher than in the double accusative or the DAT-ACC construction.

6. Discussion

According to the results of the text study of topic persistence, Hypothesis 1, which predicts that the topicality of the complement object (or the incorporated object) will show the order of DAT-ACC > Double ACC > Incorporated, is supported. In contrast, Hypothesis 2, which expects that the topicality of the complement subject (or the causee) will show the order of DAT-ACC < Double ACC < Incorporated, is not supported.

Object incorporation into the verb suppresses the importance or saliency of direct objects and trims them of their inflectional morphology. The Korean causative construction which is trimmed of its accusative case marker is an example of such object incorporation, and the topicality of its incorporated object is found to be extremely low in the present study. Compared to the topicality of the incorporated object, that of the unincorporated object in the DAT-ACC construction is rather high, which implies that the process of incorporation is very much related to the topicality of an incorporated referent. It also suggests that the double accusative construction, which shows a degree of topicality in between the other two causative constructions, is in the middle of incorporating the complement object into the verb.

Though the text study which measures TP shows a clear difference in the topicality of the complement object among the three target structures, there is no significant difference in the topicality of the causee in the structures. Based on the argument that the use of accusative case marker for the indirect object is related to the transitivity or topicality upgrading of the indirect object, the order of topicality of the causee in the three causative structures is expected to increase from the DAT-ACC to the incorporated object construction. However, the increase is not significant, which makes it difficult to say that there is any topicality difference between the structures. The non-increase of the topicality of the causee may be related to the intrinsic saliency of the causee itself. All of the causees in all of the three causative constructions are human beings. The human beings are one of the two or three participants in almost all the narratives which the subjects produced in the experiment. Even if the different case markers affects the topicality of the causees in the three constructions, their saliency or importance as a participant in the short narratives may have made it difficult to downgrade their topicality.

In summary, the use of the accusative case marker for the causee is related to the topicality downgrading of the complement object which results in the incorporation of the object into the verb, while it is not much related to the topicality upgrading of the complement subject.

7. Conclusion

The results of the experiments in the present study provides a way to explain the problematic case marking of the Korean causative construction in terms of the process of incorporation and its accompanying topicality change. The downgrading of the topicality of the complement object in the causative construction causes the incorporation of the object into the verb. The two accusative slots in one of the Korean causative constructions are the outcome of the process of the incorporation, and it is revealed in the topicality of the incorporated object in the speaker's utterance.

Consequently, Comrie's hierarchy of case marking can still be maintained as a principle to account for the case marking of the causative constructions. Even if there are two accusative slots for the complement subject and the object respectively, the accusative case marker for the complement object will lose its function, and finally its form, as the incorporation of the object into the verb proceeds. However, various case marking problems in other languages should be examined before we make a conclusion about Comrie's case hierarchy, because some languages which have many cases of syntactic incorporation may show different aspects of case marking.

7. References

- Comrie, B. 1976. "The syntax of causative constructions: cross-language similarities and divergences", In M. Shibatani (Ed.), *The grammar of causative constructions, syntax and semantics*. New York: Academic Press.
- Givón, T. 1983. *Topic continuity in discourse: A quantified text-based study*. Amsterdam: John Benjamins.
- Givón, T. 1990. *Syntax: A functional-typological introduction: vol II*. Amsterdam: John Benjamins.
- Givón, T. 1994. "The functional basis of grammatical typology: detransitive voice and inversion", In T. Givón (Ed.), *Voice and inversion*. Amsterdam: John Benjamins.
- Kim, Y. S. 1979. "Accusative case marker *-(l)ul*", *Speech*, 4.
- Kim, K. H. 1984. "Phrase structure grammar and double-object construction in Korean", *Grammar Research*, 5.
- Park, S. Y. 1990. *Functionalism*. Seoul, Korea: Hanshin Publishing Company.
- Shibatani, 1976. "Relational grammar and Korean syntax: so-called 'double-object' and 'double-subject' constructions revisited", *Language Research*, 12: 2.
- Wright, S. & Givón, T. 1987. "The pragmatics of indefinite reference", *Studies in Language*, 11: 1.
- Wright, S. 1995. *The demonstrative 'this' as an indefinite article in spoken English*. Unpublished M.A. thesis. University of Oregon.

WH- Clefts in Lummi (North Straits Salish)

Eloise Jelinek

University of Arizona

1. The Question of Wh- Movement.

Wh- roots in Lummi and other Northern Straits Salish dialects appear in the clause initial predicate position, followed by a second position clitic string.¹ They cannot serve as relative pronouns, or appear in argument positions.

- 1) a. $wet=sx^w$ b. $'\acute{a}xin=y\acute{a}x^w=\acute{t}$
 who/person=2sgNOM where/place=CONJECT=1pINOM
 Who are you? Where are we, [I wonder]?

There is no overt copula in any paradigm in Straits. Main clauses with Wh-roots, as shown in (1a), can be followed by a relative clause in a "Wh-cleft":

- 2) $ste\eta=1\acute{a}'=\emptyset$ $k^w\ le\eta-n-\acute{a}x^w$
 what/thing=PAST=3ABS DET see-NC:TRANS-2sgSUBD SUBJ
 What was it, that you saw?

The traditional term "cleft" here refers to a construction type with an initial equative main clause followed by an adjoined subordinate clause, as in (3a).

- 3) a. What was it, that you saw?
 b. What did you see?

In Straits, there are no single-clause constructions corresponding to (3b). Wh-roots never occur in A-positions, and there is no overt Wh- movement. This is consistent with the claim that Straits is a Pronominal Argument language, where lexical items are excluded from argument positions (Jelinek 1995).

2. Predicate Raising and the Second Position Clitics.

The second position INFL clitic string in Straits comprises functional

projections where Mood, Tense/Aspect, Modality, and the Subject pronoun appear, as shown in Ex. (1, 2). In the examples here, affixes to the root are marked with a hyphen, clitics with an equal sign. The root plus its affixes (shown in brackets in Ex. 4) is a phonological word, the Predicate, the domain of word stress. The clitics are always unstressed. In main clauses, the Predicate raises to adjoin the clitic string, at a FOCUS position adjoining COMP, where it checks MOOD.

- 4) a. [nəp-t-θ]=lə'=sx^w
 advise-C:TRANS-1plACC=PAST=2sgNOM
 You advised us.

There is a Question particle =ə that appears in COMP in yes/no questions.

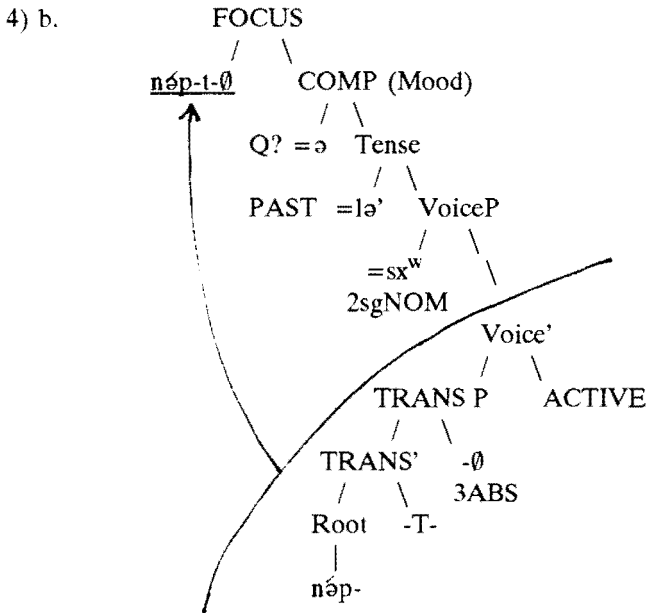

- [nəp-t-θ] =ə=lə'=sx^w
 advise-C:TRANS-3ABS =Q?=PAST=2sgNOM
 Did you advise him?

There is no overt Mood marking in Declarative sentences, and no overt Voice marker in Active sentences.

2.1. Composition of the predicate.

The predicate includes TRANSITIVITY and VOICE projections, where direct arguments check case. \pm TRANS is overtly marked. The root may be followed by one of a set of Transitivity markers ("light verbs") which mark the volitionality of the agent (traditionally called "control" in Salish studies):

- 5) $t'əm'-t-əŋəʔ=lə=sx^w$ t = "Control" TRANS
 hit-C:TRANS-1plACC=PAST=2sgNOM
 You hit us (on purpose).
- 6) $t'əm'-n-əŋəʔ=lə=sx^w$ n(əx^w) = "Non-Control" TRANS
 hit-NC:TRANS-1plACC=PAST=2sgNOM
 You hit us (accidentally).
 Or: You finally managed to hit us.

There is no overt Valence marker in simple intransitive clauses.

- 7) a. $čey=sə'=sx^w$ b. $si'em=ə=sə'=sx^w$
 work=FUT=2sgNOM noble=Q?=FUT=2sgNOM
 You will work. Will you be a/the chief?

A Transitivity marker is obligatorily followed by an internal argument (8a). There is "Activity" or Anti-Passive suffix that derives an Intransitive construction, with no Transitivity marker:

- 8) a. $leŋ-t-əŋəʔ=lə=sx^w$ b. $leŋ-el's=sən$
 see-C:TR-1plACC=PAST=2sgNOM see-ANTIPASS=1sgNOM
 You looked at us. I'm looking.

When no phonologically overt pronoun is present following TRANS, a third person Absolute argument is entailed, as in (4, 9). These ZERO third person Absolute arguments are specific and referential (unless bound by a quantifier). Reading (9b) is excluded.

- 9) $leŋ-t-θ=lə=sx^w$
 see-C:TR-3ABS=PAST=2sgNOM
 a. You looked at him/it.
 b. *You looked at somebody/something.

There is an "ergative split": first and second person pronouns are Nominative/Accusative, while third person pronouns are Ergative/Absolute.

Third person Ergative is an **overt** internal argument. In (9) the Nominative external subject pronoun =sx^w follows the PAST clitic; in (10) the internal Ergative -s pronoun precedes PAST, as shown in the underlined sequences.

- 10) leŋ-t-s=lə' = θ
 see-C:TR-3ERG=PAST=3ABS
 a. He looked at him/it.
 b. *He looked at somebody/something.

The Absolutive (third person intransitive subject or transitive object) is the only null pronoun in any paradigm. The Pronominal Arguments are not agreement features. There are no free-standing pronouns in Straits with which the pronominal affixes that check case at TRANS and VOICE could "agree" in the feature of person. Thus, "pro-drop" is excluded.

Above the TRANS P is the VOICE projection (Active, Passive, Middle, etc.), where the Subject appears (Kratzer 1994). In Passives (10), the VOICE suffix -ŋ marks the subject as **affected**, and derives an intransitive construction; it is mutually exclusive with ERG or ACC pronouns. The Passive marker is also integrated into the predicate word; in (11) it receives word stress.

- 11) t'əm'-t-ŋ=lə'=sən ('ə cə swəy'qə)
 hit-C:TR-PASS=PAST=1sgNOM OBL DET male
 I was hit (by the man).

Note that the Transitivity still marks the volitionality of the "implicit" agent in (11). This agent may optionally be identified in an oblique adjunct, as shown. In MIDDLES (12), -ŋ also marks the subject as affected, but no distinct agent is presupposed in the absence of a Transitivity.

- 12) so'k^w-ŋ=lə'=sx^w
 bathe-MIDDLE=PAST=2sgNOM
 You bathed.

2.2. Evidence for the raising analysis: serial predicates.

In the information structure of the Lummi clause, the root, TRANS and VOICE markers, and any internal argument, constitute the new information. This new information is packaged into a phonological word with primary stress. The INFL clitics, including the Subject, are unstressed backgrounded information. The Predicate + the INFL clitic complex contains both the

direct arguments, which are exclusively pronominal affixes, discourse anaphors. In Straits, information new to the discourse is never introduced in an argument position, only as a predicate, an adverbial, or an adjunct.

In complex or serial predicates, only the **first** word of the complex raises to adjoin COMP; the second remains in situ. In Ex. (13) below, there is only one clause. There is just one clitic string, and no subordinate clause marking.

- 13) a. 'ən'ɛ=ə=lə'=sx^w leŋ-n-ɔŋəʈ
 come=Q?=PAST=2sgNOM see-NC:TR-1plACC
 Did you come-[to]-see [visit] us?

The final word of the serial predicate is followed by the TRANS P.

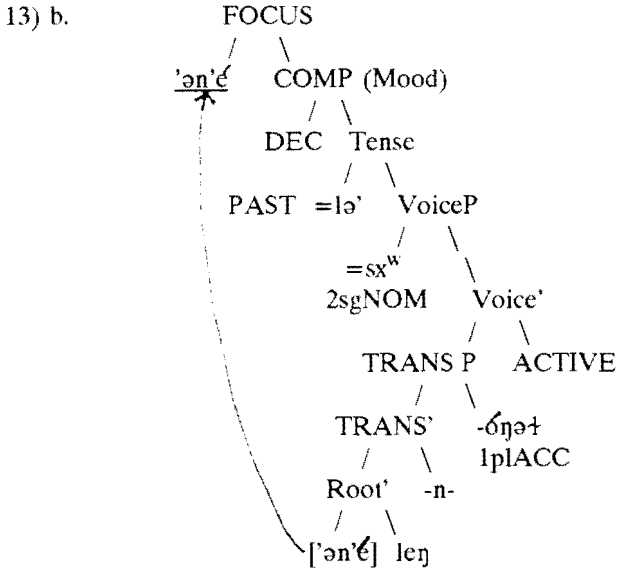

- 'ən'ɛ=lə'=sx^w leŋ-n-ɔŋəʈ
 come=PAST=2sgNOM see-NC:TR-1plACC
 You came [to] see [visited] us.

2.3. Relative clauses are Determiner Phrases.

Relatives have no MOOD COMP; Question particles are excluded, but Tense/Aspect/Modality may be marked. The Relative clause COMP is the Determiner, and with serial predicates, both lexical roots remain below

COMP, as shown in (14).

- 14) si'em=lə'=θ cə 'ən'e leŋ-n-oŋəʔ
 noble=PAST=3ABS DET come see-NC:TR-1pIACC
 It was a/the chief, that came to see us.

Determiner Phrases are adjoined subordinate structures that never appear in sentence initial position. Any root may be focused in a main clause, or backgrounded in a relative.

- 15) a. qiləs=lə'=θ cə si'em
 lonely=PAST=3ABS DET noble
 He was lonely, the chief.
- b. si'em=lə'=θ cə qiləs
 noble=PAST=3ABS DET lonely
 He was a/the chief, the lonely [one].

Relative clauses that may follow a Wh- main clause do not differ from the ordinary Relative clauses seen in examples (14, 15). Relative clauses in Straits are "internally headed" adjoined subordinate clauses; there are no embedded clauses. Relatives contain a "gap" or variable that is bound by the Determiner, which functions as an iota operator; this gap does not represent movement of an argument out of the relative clause. By definition, relative clauses universally are linked by predication to some main clause argument. The head of the relative in Straits is exclusively third person. There are the following subtypes:

16) Determiner Phrase ("headless relative") types:

cə leŋ-t-ən	the one that I see	Patient headed
cə leŋ-t-oŋəs	the one that sees me	Agent headed
cə čey	the one that works	Subject headed

17) Other examples of Subject headed relatives:

cə leŋ-t-ŋ	the one that is seen	(Passive subject)
cə 'əy'	the [one that is] good	
cə nə-ten	(the) my mother	
cə ŋən'	the many	

There is no class of lexical roots that is confined to relative clauses, to a

position following a Determiner, and excluded from serving as head of a main clause. NPs are derived by the Determiner, and there is no category of NPs that is syntactically distinct from Relatives. Proper names also occur with Determiners. The default reading of Relatives is definite, but they may receive indefinite readings in certain contexts, for example, in existential constructions. There is no Determiner quantification in Straits (Jelinek 1995); the Determiner/Complementizers are Demonstratives that do not mark number, but mark gender, proximity, and visibility.

3. The Two Cleft Types.

Wh- questions in Straits occur in two types of cleft constructions, that differ in including either a) Relative clauses or b) Nominalized Clauses.

Lambrecht (1994) defines "anti-topics": backgrounded "afterthought" adjuncts that re-identify the familiar referent of a main clause pronoun.

18) He's a nice guy, your brother.

Straits Relative Clauses function as anti-topics, as in the following clefts.

19) $wet=1ə'=θ$ $k^w leŋ-n-ŋəʔ$
 who/person=PAST=3ABS DET see-NC:TR-1plACC
 Who_i was it_i, that_i _{-i} saw us? (Agent headed REL)

20) $steŋ=1ə'=θ$ $k^w leŋ-n-əx^w$
 what/thing=PAST=3ABS DET see-NC:TR-2sgSUBD SUBJ
 What_i was it_i, that_i you saw _{-i}? (Patient headed REL)

The k^w Determiner marks the referent as not currently in sight, or abstract. The examples in (21, 22) show comparable clefts where a non-Wh root has the main clause focus.

21) $stoməʃ=1ə'=θ$ $k^w leŋ-n-ŋəʔ$
 warrior=PAST=3ABS DET see-NC:TRAN-1plACC
 He_i was a warrior_i, that_i _{-i} saw us.

22) $snəx^wəʔ=1ə'=θ$ $k^w leŋ-n-əx^w$
 canoe=PAST=3ABS DET see-NC:TR-2sgSUBD SUBJ
 It_i was a canoe_i, that_i you saw _{-i}.

We saw above (Ex. 4) that yes/no questions have a question particle in COMP, producing a +WH COMP. The Wh- roots are either +WH or -WH ("who/person", "what/thing", etc.) In main clauses, they are +WH, and select a +WH COMP. As lexical heads of Relative clauses, which have no Mood COMP, Wh- roots are -WH, and may be glossed as indefinite quantifiers. In languages where Wh- words do not serve as relative pronouns, this quantificational reading of Wh- words is commonly seen (Cheng 1991).

- 23) a. $le\eta-n-\emptyset=l\alpha=s\alpha n$ cə steŋ
 see-NC:TR-3ABS=PAST=1sgNOM DET thing
 I saw it, the/a thing.
- b. $le\eta-n-\emptyset=\alpha=l\alpha'=s\alpha^w$ cə wet
 see-NC:TR-3ABS=Q?=PAST=2sgNOM DET person
 Did you see him, the/a person?

The second cleft type contains a Nominalized clause. These clauses differ from Relatives morphologically in having a Possessive pronoun as Subject. In contrast to Relative clauses, there is no "gap"; all arguments are overt. The head of a Relative clause is some participant in the event or situation described in the clause. For Nominalized clauses as in (24), Partee (p.c.) proposes that the "distinguished argument" is the event argument.² Examples:

- 24) a. $'\alpha y'=\emptyset$ $k^w \alpha n-s-k^w \alpha n i \eta-t-o \eta \alpha t$
 good=3ABS DET 2sgPOSS-NOML-help-C:TR-1plACC
 It's good, your helping us (that you help us).
- b. $x\check{c}i-t-\emptyset=s\alpha n$ $k^w \alpha n-s-ye'-l\alpha'$
 know-C:TR=1sNOM DET 2sgPOSS-NOML-go-PAST
 I figured it out, that you went.

Further evidence that the distinguished argument in Nominalized clauses is the event argument is provided by adjoined temporal clauses, in stating temporal relations between events. Temporal clauses are nominalizations.

- 25) $q'\alpha q'\epsilon n \alpha t=\emptyset$ $'\alpha t$ $\xi\text{-}\xi \alpha t\text{-}\eta\text{-}s$ cə 'əs'eləx^w
 slow=3ABS CONJ NOML-walk-MIDDLE-3POSS DET elder
 He is slow when he walks, the old man.

There is a second important question type in which Nominalized clauses appear, where the event argument is primary. Straits has a class of roots that

can be used to question locative, temporal, purpose or manner notions; 'əxin "where/place", čən'teŋ "when/time", x^wəniŋ "why/reason", x^wən'eŋ "how/manner".³ This group of Wh- roots corresponds to adverbial Wh-expressions across languages, that take scope over the event argument.

- 26) čən'teŋ=lə'=θ k^w ən'-s-leŋ-nəx^w-θ
 when/time=PAST=3ABS DET 2sgPOSS-NOML-see-NC:TR-3ABS
 When was it, your seeing it?

Compare the object-headed Relative Clause Wh- cleft in (2) above:

- 2) steŋ=lə'=θ k^w leŋ-n-əx^w
 what/thing=PAST=3ABS DET see-NC:TR-2sgSUBD SUBJ
 What was it, that you saw?

Another example of this "adverbial" type of Wh- root in a Nominalized clause cleft:

- 27) x^wəniŋ=lə'=θ k^w ən-s-ye'
 why/reason=PAST=3ABS DET 2POSS-NOML-go
 Why was it, your going?

These Wh- roots cannot occur in clefts with a Relative clause, since they do not question participants that may be relativized. The generalization is:

- 28) Relative Clause Wh-clefts are employed when the subject of the Wh-predicate is interpreted as coindexed with a **Pronominal Argument** of the predicate selected for relativization. Otherwise, a Nominalized clause cleft is employed.

The generalization stated in (28) applies to additional construction types in Straits. Syntactically oblique arguments are not represented by Pronominal Arguments in Straits, only by oblique nominals. There are no prepositional phrases with pronominal objects in Straits (Jelinek, 1998).

- 29) Oblique adjuncts cannot be relativized; there are only Subject and Direct Object (or Ergative) Pronominal Arguments.

Therefore, "indirect objects" (Obliques) cannot be focused in Relative Clause clefts. In constructions that focus a referent that cannot be relativized, a Nominalized Clause cleft is employed. For example, the root 'iɬən "eat" is

syntactically intransitive. To identify the object consumed, an oblique nominal may be optionally included.

- 30) 'iʔən=ɪə'=θ 'ə cə s-ʕeenəx^w
 eat=PAST=3ABS OBL DET NOML-catch
 He ate [a/the] salmon.

In (31), a Nominalized clause "his food/eating" is included.

- 31) s-ʕeenəx^w=yəx^w=θ k^w s-'iʔən-s
 salmon=CONJECT=3ABS DET NOML-eating-3POSS
 It's probably salmon, his food/eating.

Some adjoined nominals can refer to an object as well as an event. This may be a question of predicate class, having to do with the telicity of the root. Similar ambiguities are observed with some gerunds and derived nominals across languages: "the cooking", "the serving" can refer both to events or products. A Nominalized Clause Wh-cleft with the root 'iʔən is given in (32):

- 32) steŋ=yəx^w=θ k^w s-'iʔən-s
 what/thing=CONJECT=3ABS DET NOML-eating-3POSS
 What could it be, his food/eating?
 (Or: I wonder what it is, his food?)

There are no ditransitive stems in Straits. Only one object pronoun is licensed by TRANS. With the stem 'oŋəs-t, "give"+C:TRANS, the direct object pronoun marks the animate recipient. The item exchanged may be optionally identified in an oblique nominal (33).

- 33) 'oŋəs-t-oŋəʔ=ɪə'=səx^w 'ə cə s-ʕeenəx^w
 give-C:TR-1plACC=PAST=2sNOM OBL DET salmon
 You gifted us [with] a/the salmon.

Example (34) shows a cleft construction with focus on what was given.

- 34) s-ʕeenəx^w=ɪə'=θ k^w 'ən-s-'oŋəs-t-oŋəʔ
 salmon=PAST=3ABS DET 2sPOSS-NOML-giving-C:TR-1plACC
 It was salmon, your gift/giving us.

Ex. (35) shows a parallel Wh-cleft construction:

- 35) $ste\eta=1\partial'=\emptyset$ k^w 'ən-s-'oŋəs-t-oŋəʔ
 what/thing=PAST=3ABS DET 2sPOSS-NOML-giving-C:TR-1plACC
 What was it, your gift/giving us?

There is no gap in the Nominalized clause, and no syntactic derivation of the cleft in (35) from some other sentence. Lummi has no constructions corresponding to (36), only clefts as in (35).

- 36) What did you give us?

The examples given above show that the focused elements in both Relative and Nominalized Clause clefts are not restricted to Wh- roots. There is no preposition or oblique marker in either the main or subordinate clauses in these clefts, or other syntactic evidence of a "gap" or agreement suggesting extraction or Wh- movement.

4. Indirect Questions: Hypothetical clauses.

We have seen that Wh- roots in Straits can have either a +WH or -WH feature. In main clauses, Wh- roots are +WH, while as lexical heads of Relative Clauses, they are -WH, denoting "person, thing, place", etc. In Hypothetical or Irrealis subordinate clauses, Wh- roots appear with Irrealis Subject marking, and are +WH. Third person Irrealis subject is overt. Just as with Nominalized clauses, there are no "gaps" in this clause type.

- 37) $\check{c}te-t-\eta=s\partial n$ k^w $ste\eta-\partial s$
 ask-C:TR-PASS=1sNOM DET what/thing-3IRR
 I was asked what it was.

- 38) $\check{c}te-t-\eta=s\partial n$ k^w $wet-\partial s$
 DET who/person-3IRR
 I was asked who it was.

- 39) $\check{c}te-t-\eta=s\partial n$ k^w 'əxin-əs
 DET where/place-3IRR
 I was asked where it/he was.

Hypothetical clauses can have any lexical root as head, including weak quantifiers. Hypothetical clauses that do not contain a Wh- root are often interpreted as "if" or conditional clauses.

40) čte-t-ŋ=sən k^w ŋən'-əs
 ask-C:TR-PASS=1sNOM DET many-3IRR
 I was asked if there were many.

41) čte-t-ŋ=sən k^w ni'-əs
 DET EXIST-3IRR
 I was asked if there were any.

42) čte-t-ŋ=sən k^w ye'-əx^w
 DET go-2sgIRR
 I was asked if you went.

Hypothetical clauses also appear in environments corresponding to those where subjunctive or other Irrealis inflection occurs across languages.

43) nəp-t-ŋ=sən k^w čey-ən
 advise-C:TR-PASS=1sgNOM DET work-1sgIRR
 I was advised to work [that I work].

I conclude that there is no clause type in Straits, either main or subordinate, containing a gap that can be attributed to Wh- movement.

5. Other Evidence on Pronominal Arguments.

We have seen that the particle 'ə that introduces oblique DET P in Straits cannot occur with object pronouns, only with nominals. Pronominal Objects are confined to the position following TRANSITIVE.

5.1. The person-deictic roots.

If arguments are restricted to pronouns that are confined to functional projections in IP, then certain problems for the grammar must follow:

- 44) a. How are pronominal referents to be focused, since clitics cannot have focus?
 b. How are oblique pronominal objects to be expressed?
 c. How can pronouns be used predicationally?

Straits grammar solves these problems with the use of a set of "person-deictic" roots. Partee (1987) notes that pronouns across languages typically show type-

shifting from referential *e* to predicational $\langle e, t \rangle$ uses in context.

- 45) a. I saw you. Referential "you"
 b. The one I saw was YOU. Predicational "YOU"

In Pronominal Argument languages, pronouns do not show type-shifting of this kind; they are exclusively of semantic type *e*, serving as discourse anaphors that cannot be focused. The Straits person-deictic lexical roots are a distinct paradigm of predicates, of type $\langle e, t \rangle$. They inflect for a third person subject. They do not appear in A-positions, and do not resemble the Pronominal Arguments in morphological shape. They occur only as lexical heads, either of finite clauses (46a), or under the scope of a Determiner (46b). They are used to mark **contrastive focus**.⁴

- 46) a. $nək^w=yəx^w=lə'=θ$ $cə \text{ } ləŋ-n-ən$
 YOU=CONJECT=PAST=3ABS DET see-NC:TR-1sgSUBD SUBJ
 It must have been YOU, the one I saw.
- b. $k^wəniŋ-t-θ=sən$ $sə \text{ } nək^w$
 help-C:TR-3ABS=1sgNOM DET:FEM YOU
 I helped [the one who is] YOU.

These person deictic roots cannot occur with first or second person subject or object Pronominal Arguments. Compare (46) and (47).

- 47) a. $* nək^w=sx^w$ $cə \text{ } ləŋ-n-ən$
 YOU=2sgNOM DET see-NC:TR-1sgSUBD SUBJ
- b. $* k^wəniŋ-t-əŋəs=sən$ $sə \text{ } nək^w$
 help-C:TR-2sACC=1sgNOM DET:FEM YOU

These roots are also used for oblique pronominal referents:

- 48) $t'əm'-t-ŋ=sən$ 'ə $cə \text{ } nək^w$
 hit-C:TR-PASS=2sgNOM OBL DET YOU
 I was hit by YOU.

We have seen that in an Irrealis clause third person subject marking is overt. This overt person subject inflection is further evidence that the person-deictic roots are third person.

- 49) čte-t-ŋ=sən k^wə nək^w-əs
 ask-C:TR=PASS=1sgNOM DET YOU-3IRR
 I was asked if it was YOU.

The fact that the person-deictic roots have the feature of third person rules out the possibility that the Pronominal Arguments could constitute agreement with "dropped" person-deictic roots.

5.2. The absence of Determiner Quantification.

Jelinek (1995) shows that "strong" quantifiers in Straits are unselective adverbials (Lewis 1975). These adverbials have a special LINK syntax; they appear in clause initial position, linked to the main clause by a conjunctive particle 'əw'. They are followed by the clitic string, showing that, as the first element in the predicate complex, they have raised to the Focus position.

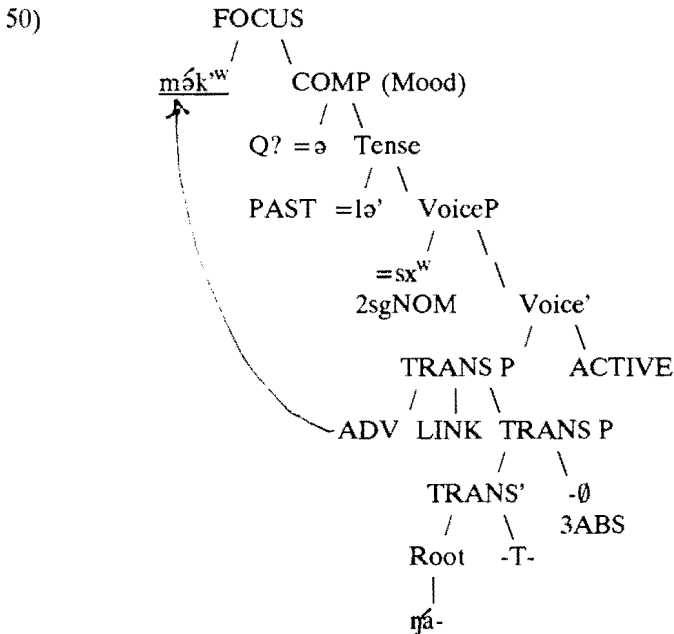

- mək^w = ə = lə' = sx^w 'əw' ŋá-t-∅
 ALL = Q? = 2sgNOM LINK eat-C:TR-3ABS
 Did you eat it up completely/eat all of them?

Ex. (51) shows the variability in scope of the unselective adverbial.

- 51) mək^w=t 'əw' ŋa-t-θ
 ALL=1p|NOM LINK eat-C:TR-3ABS
 1. We ate it up completely.
 2. We ate all of them.
 3. All of us ate it/them.....

Another example of an unselective adverbial:

- 52) λ'e'=sən 'əw' t'əm'-t-θ
 ADD-lsgNOM LINK hit-C:TR-3ABS (ADD = "additionally")
 1. I hit him again.
 2. I also hit him.

In languages with Determiner quantification, strong Determiner quantifiers have inherent focus; the lexical head of the quantified NP is presuppositional. There is focus on the A-position in which the strong quantified NP occurs. In Straits, as in all Pronominal Argument languages, arguments never have focus. Focus is confined to lexical heads, and arguments are restricted to backgrounded discourse anaphors. In Straits, the predicate (or the initial word of the complex predicate) raises to the Focus position. This initial word may be a strong adverbial quantifier, followed by the clitic sequence, the LINK particle, and the predicate to which it is linked.

Within Relative clauses, the strong quantifier also manifests variable scope, evidence of its adverbial character:

- 53) cə mək^w pəq'
 DET ALL white
 those that are all white
 1. the completely white one[s] (not parti-colored)
 2. the set all members of which are white (no red ones)

Weak quantifiers in Straits are ordinary open class roots. Unlike the strong quantifiers, they are not LINKED to another root, and may be the only root in the clause.

- 54) ŋən'=t
 many=1p|NOM
 We are many.

6. Conclusions.

The raising to Focus process shown by Wh- words in Lummi is identical to the raising shown by all predicates in the language. The Lummi data support the findings of Troike (1990, 1992), and those of Cheng (1991), who identifies a parametric class of languages, including Mandarin Chinese, that lack Wh-movement at spell-out, and have question particles and Wh- clefts. These languages also have Wh- words that serve as indefinites, and never serve as relative pronouns -- other attributes shared by Straits. Georgopoulos (1989) argues that Palauan also confines Wh- words to clefts with variable binding, and Richards (1993) shows that Tagalog has only Wh- clefts. Lummi has no clause types, main or subordinate, unique to Wh- constructions, and I conclude that in Lummi there is no "Wh- agreement" of the kind Chung (1994) identifies in Chamorro.⁵

To summarize: In Lummi main clauses the Predicate (or the first word of a complex predicate) raises to Focus, and checks Mood in COMP. The COMP selected is +WH, when the "yes/no" question particle or a +WH root is present. In Hypothetical or Irrealis clauses, Mood is also +WH; other subordinate clause types, including relatives, are -WH. Some typological features of Wh- constructions in Lummi that follow from argument type:

- 55) a. There are no clauses with two Wh- roots, since each root heads a clause (main or subordinate).
 b. There are no "Wh-in-situ" constructions, since there are no lexical items in A-positions.
 c. There is no Wh- movement; all predicates raise to the Focus position in their clauses before spell-out.

The fact that Wh- questions in Straits Salish are cleft constructions, and that these roots never occupy A-positions, but appear in the predicate position, is consistent with the proposal that Straits has the parametric property of Pronominal Arguments: that is, lexical items are uniformly excluded from A-positions. This in turn follows from the constraints on Focus structure and information structure in the language, and the consequent lack of Determiner Quantification. Arguments are restricted to discourse anaphors, and referents are introduced or re-identified in context via clausal predicates.

Notes

¹ I thank Emmon Bach, Andrew Barss, David Basilico, Andrew Carnie, Lisa

Cheng, Dick Demers, Dwight Gardiner, Dale Kinkade, Terry Langendoen, Tim Montler, Barbara Partee, Montserrat Sanz, and Rudy Troike for comments and generous help. None of these is responsible for any errors or omissions. The analysis given here is based on field work on Lummi and Samish/Malahat during the summers of 1982 - 1988, supported by the Wenner-Gren Foundation and the American Philosophical Society. I am greatly indebted to Dick Demers, who generously made available to me his field notes from over two decades of work on Lummi. I am grateful to the following Straits Salish speakers: Lena Daniels, Victor Underwood, Al Charles and Agatha McCloskey. I follow the classification of the Straits Salish group given in Montler 1996b: Northern Straits comprises a group of related dialects including Lummi, Samish, Saanich, Songish, and Sooke; Klallam is less closely related. The Northern Straits dialects share major syntactic properties, and from what I have been able to determine from the publications of colleagues working on Straits, the analysis I propose here applies generally to the other Straits dialects as well.

² I thank Barbara Partee for this observation.

³ The rich inventory of Wh- roots and stems in Straits, like other Salishan languages, includes a number of items with specialized meaning, such as *ʔinʔ-t* "say what/something" and *stajə-t* "do what/something". Montler (1991) provides a complete inventory of Wh- roots for Saanich, and Kinkade (1994) gives a comparative diachronic analysis of Wh- roots in Salishan.

⁴ See discussion in Kiss (1998) on the quantificational nature of contrastive (identificational) focus, which selects some member(s) of a presupposed set.

⁵ There are extensive parametric differences across the members of the large Salishan family. In the Interior Salish languages, in contrast to the Straits dialects, we find a) no second position clitic string including the subject; b) free-standing pronouns; c) DET P occurring initially in the clause; d) no LINK syntax for the strong quantifiers; and e) Determiner Quantification, including plurality and a Realis/Irrealis contrast (Matthewson 1996; this differs from the Lummi *kʷ*, which may mark a familiar referent that is not currently in sight). Many of these languages also lack Ergative case. Straits has a person hierarchy, not discussed here for lack of space, that is not manifested in most of the Interior languages. The syntax of Wh- words is also different in Interior Salish. Wh- clefts seem to be common to the whole Salishan family, but their properties vary across the sub-branches; for example, there is a greater range of subordinate clause types appearing in Wh- clefts

(Davis, Gardiner and Matthewson, 1993; Gardiner 1998). See Levine (1984) on argument structure in Kwakwala, a non-Salish language of the Northwest Coast area, for evidence that some of the parametric properties considered here are areal in distribution, appearing outside the Salishan language family.

References

- Bach, Emmon, Eloise Jelinek, Angelika Kratzer and Barbara Partee, eds., 1995. *Quantification in Natural Languages*. Dordrecht: Kluwer.
- Cheng, Lisa. 1991. *On the Typology of Wh-Questions*. MIT dissertation.
- Chomsky, Noam. 1995. *The Minimalist Program*. Cambridge: MIT Press.
- Chung, Sandra. 1994. "Wh-Agreement and 'Referentiality' in Chamorro." *LINGUISTIC INQUIRY* 1-44.
- Davis, Henry, Dwight Gardiner and Lisa Matthewson. 1993. "A Comparative Look at Wh-Questions in Northern Interior Salish." Papers for the 28th ICSNL, University of Washington, Seattle.
- Gardiner, Dwight. 1998. "Topic and Focus in Shuswap (Sekwepemctsin)." *Salish Languages and Linguistics*, Ewa Czaykowska-Higgins and M. Dale Kinkade, eds. Berlin: Mouton.
- Georgopoulos, Carol. 1989. "Syntactic Variables: Resumptive Pronouns and A'-binding in Palauan." MS, University of Utah.
- Jelinek, Eloise. 1995. "Quantification in Straits Salish." *Quantification in Natural Languages*, Bach, et al, eds. Dordrecht: Kluwer.
- Jelinek, Eloise. 1998. Prepositions and the Noun/Verb Question in Salish. *Salish Languages and Linguistics*, Czaykowska-Higgins, Ewa, and M. Dale Kinkade, eds. Berlin: Mouton.
- Kinkade, M. Dale. 1994. "Salishan interrogatives from a diachronic perspective." Fifth Spring Workshop on Theory and Method in Linguistic Reconstruction. Pittsburgh, Pennsylvania.
- Kiss, Katalin E. 1998. "Identificational vs. Information Focus." *LANGUAGE* 74.2, pp. 245-273.
- Lambrecht, Knud. 1994. *Information Structure and Sentence Form*. Cambridge Studies in Linguistics, 71. Cambridge: Cambridge University Press.
- Kratzer, Angelika. 1994. "On External Arguments." *Functional Projections*, University of Massachusetts Occasional Papers 17. Amherst: University of Massachusetts.
- Levine, Robert. 1984. "Empty Categories, Rules of Grammar, and Kwakwala Complementation." *The Syntax of Native American Languages*. Cook, Eung-Do and Donna Gerds, eds., Syntax and Semantics, vol. 16. New York: Academic Press.

- Lewis, David. 1975. "Adverbs of Quantification." *Formal Semantics of Natural Language*. E. L. Keenan, ed. Cambridge: Cambridge University Press.
- Matthewson, Lisa. 1996. *Determiner Systems and Quantificational Strategies: Evidence from Salish*. University of British Columbia dissertation.
- Montler, Tim. 1986. *An Outline of the Morphology and Phonology of Saanich, North Straits Salish*. University of Montana Occasional Papers in Linguistics No. 4.
- Montler, Tim. 1991. *Saanich, North Straits Salish: Classified Word List*. Canadian Ethnology Service, Paper No. 119, Mercury Series. Canadian Museum of Civilization.
- Montler, Tim. 1996a. "Some Klallam Paradigms". Papers for the 31st ICSNL. Vancouver: University of British Columbia.
- Montler, Tim. 1996b. "Languages and Dialects in Straits Salishan." Papers from the 31st ICSNL. Vancouver: University of British Columbia.
- Partee, Barbara. 1987. "Noun Phrase Interpretation and Type-Shifting Principles." *Studies in Discourse Representation and the Theory of Generalized Quantifiers*, Groenendijk, J., D. de Jongh, and M. Stokhof, eds., GRASS 8. Dordrecht: Foris.
- Richards, Norvin. 1993. *Who Moves Where in Which Language?* MIT dissertation
- Troike, Rudolph C. 1990. "The Role of Specificity in Indefinite Quantification, Wh-Questions, and Scope in Chinese and Universal Grammar". Linguistics Colloquium, University of Arizona.
- Troike, Rudolph C. and Mae-Ran Park. 1992. "Questions and Quantification in Korean." *ENGLISH LANGUAGE AND LITERATURE (Korea)*, 38.4:801-811.

The Role of Typology in L2 Acquisition

Euen Hyuk (Sarah) Jung

Georgetown University

1. Introduction

Previous studies on the role of topic-prominent/ subject-prominent typology in second language (L2) acquisition have led to two controversial claims. One set of findings has argued that independent of learners' first language (L1), the process of L2 acquisition is characterized by an early universal topic-prominent stage and has suggested that topic-prominent/subject-prominent typology is not transferable. Fuller and Gundel (1987) compared oral narratives from English native speakers and learners of English as an L2 from both topic-prominent L1 (e.g. Chinese, Japanese, and Korean) and non-topic-prominent L1 (e.g. Arabic, Farsi, and Spanish) backgrounds with regard to six topic-prominent features (e.g. zero anaphora, surface coding of topic, dummy subjects, double subject constructions, subject-creating constructions, and subject-verb agreement). In order to measure the degree of topic-prominence of each narrative, a three-point implicational scaling was employed, in which no difference was found between speakers of topic-prominent and non-topic-prominent languages in their English oral production. In addition, it was found that L2 learners as a whole produced more topic-prominent features in their interlanguage than the subject-prominent target language speakers (i.e. English) and that their interlanguage is intermediate in topic-prominence between topic-prominent and subject-prominent native languages.

Another set of studies has maintained that learners from topic-prominent L1 backgrounds transfer the topic-prominent features in their L2 production. Heubner (1983) conducted a one-year longitudinal study of a Hmong adult speaker (in his early 20's) learning English as an L2 in a natural context with no formal instruction and found that the learner's interlanguage progressed from the initial topic-comment to subject-predicate stages through morphological syntactization. The learner treated the copula "is" as a topic boundary marker at the beginning stage of learning. He also consistently omitted the English definite article in the subject noun phrase positions, but not in the object noun phrase positions. It was claimed that this phenomenon is due to the carryover into the target language of topic-prominent features in Hmong. Since in Hmong a topic is typically definite and it is

positioned sentence-initially, the learner regarded any sentence-initial noun phrase in English as a topic which carries the feature of definiteness and did not see an (extra) need to mark sentence-initial noun phrases with definite articles.

Similarly, Schachter and Rutherford (1979) found numerous examples of L1 topic-prominence transfer in the L2 written English by speakers of topic-prominent languages (e.g. Chinese and Japanese). They argued that constructions which appeared to be malformed passives produced by Chinese and Japanese learners were actually instances of typological transfer from L1 discourse functions (i.e. topic-comment constructions) to L2 syntactic forms. Before discussing their arguments, a brief distinction between topic and subject given by Li and Thompson (1976: 466 cited in Schachter and Rutherford 1979: 6) will be useful:

We may single out 3 basic factors in underlying these criteria . . . for distinguishing between T[opic] and S[ubject]: discourse strategy, noun-verb relations, and grammatical processes. The subject has a minimal discourse function in contrast with the topic . . . the topic, but not necessarily the subject, is discourse-dependent, serves as the center of attention in the sentence, and must be definite. As for N-V relations and grammatical processes, it is the subject rather than the topic that figures prominently. Thus subject is normally determined by the verb and selectionally related to the verb; and the subject often obligatorily controls verb agreement. These properties of the subject are not shared by the topic. In conclusion the topic is a discourse notion whereas the subject is to a greater extent a sentence-internal notion . . .

According to Schachter and Rutherford's analysis, each initial noun phrase in the examples below (examples (1) and (2)) was treated as a topic rather than a subject, which is grammatically unrelated to the following verb. Subjects and objects were also dropped by the topic-prominent language discourse conventions that subjects and often objects are not obligatory in a sentence structure whenever they are recoverable from a context:

(1) ? Most of food which is served in such restaurants/ have cooked already.

(2) ? Irrational emotions are bad but rational emotions/ must use for judging.

(Schachter and Rutherford 1979: 7)

By this reasoning, they provided fuller reading of examples (1) and (2) as:

(1) a. Most of the food which is served in such restaurants [they] have cooked [it] already.

(2) a. Irrational emotions are bad but rational emotions, [one] must use [them]

for judging.

(Schachter and Rutherford 1979: 8)

Furthermore, Rutherford (1983) examined writing samples produced by ESL learners from both topic-prominent (e.g. Mandarin, Japanese, and Korean) and subject-prominent (e.g. Spanish and Arabic) languages and found that learners from topic-prominent L1 backgrounds significantly overproduced topic-prominent structures in their English L2 writing. He also found in L2 written productions by these learners at different proficiency levels that there was a general shift in the use of topic-comment to target-like subject-predicate structures as the learners' L2 proficiency level increased. The following examples of learners' interlanguage represent a typical developmental sequence of such a syntactic emergence ("syntacticization" in Rutherford's terms) (Rutherford 1983: 362):

- (3) a. In my country man and woman chooses husband or wife \emptyset is very simple
-
- (level 3)
- b. Choose a good husband or wife, this is very important problem for everybody
-
- (level 4)
- c. ... choosing a husband and a wife is one of the essentials of life ...
-
- (level 5)

In example (3), following his argument, the earliest stage of L2 learning is characterized by absence of the "subject category" if it is coreferential with a topic (3a); at the middle stage the category "subject" coexists with coreferential topic (3b); and at the final stage topic has been reanalyzed by the learner as a "subject" (3c).

Such conflicting conclusions discussed above, as Jin (1994) has pointed out, may be due to the fact that these studies were based only on data involving English as a second language, a subject-prominent language and the fact that they investigated only two directions of language transfer, either topic-prominent to subject-

investigated the interlanguage from the direction of subject-prominence to topic-prominence, such as English to Korean. The role of topic-prominent/ subject-prominent typology in L2 acquisition cannot be fully accounted for until more studies are carried out in the direction of subject-prominence to topic-prominence (Jin 1994). The present study aims to provide further insight into the role of topic-prominent/subject-prominent typology by investigating English learners' acquisition of Korean as an L2, more specifically, by investigating a relationship between the learners' proficiency levels (i.e. "advanced" vs. "intermediate") and the learners' use of topic-prominent features (i.e. zero anaphora, topic markers "(n)un," and double subject constructions) in their L2 oral productions.

2. Topic-prominent Features in Korean versus Subject-prominent Features in English

Li and Thompson (1976) first introduced the notion of topic-prominent versus subject-prominent typology, in which English is regarded as a subject-prominent language, while Korean is viewed as a topic-prominent language (Sohn 1980). Topic-prominent features in Korean can be discussed in terms of zero anaphora, topic marker "(n)un," and double subject constructions.

2.1. Zero anaphora

Korean allows subjects and objects to drop when they are recoverable from contexts as in example (4):

(4) A: ne ikes philyohani?

You this need?

'Do you need this?'

B: Ø philyohay Ø

Ø need Ø

'Yes, I need it.'

In answer to speaker A's question "ne ikes philyohani?" ('Do you need this?'), Speaker B's response "philyohay" (the verb 'need' alone) is grammatically correct, even though the subject and the object are not overtly marked. However, as in example (5), English does not allow subjects and objects to drop as Korean does. Speaker B's response to speaker A's question is ungrammatical when the subject and/or the object are not overtly marked.

(5) A: Do you need this?

- B: a. * \emptyset need it.
 b. * I need \emptyset .
 c. * \emptyset need \emptyset .

2.2. Topic marker “(n)un”

While English has left-dislocation as a way of topic-marking as illustrated in example (6), Korean as a topic-prominent language has a specific morphological device for such purposes, in addition to the use of syntactic positions. In Korean, topic is morphologically marked by topic markers “(n)un” as in example (7), in which the first noun phrase, “saynsen” (‘fish’) was topicalized by the use of topic marker “un”:

(6) a. Mary, John saw her yesterday.

(Prince 1983: 1 cited in Nishimura 1990: 367)

b. Beans, I don’t like.

(Prince 1981: 249 cited in Nishimura 1990: 367)

(7) saynsen-*un* yene-ka massissta.

Fish-T salmon-S delicious-DEC.

‘As for fish, salmon is delicious.’

T: Topic marker; S: Subject marker; DEC: Declarative

2.3. Double subject construction

Double subject constructions are among the basic sentence types (“unmarked” forms) in topic-prominent languages such as Korean, whereas they occur exclusively in a very casual spoken register (“marked” form) in subject-prominent languages such as English (Bland 1981). Example (8) illustrates the use of double subject constructions in Korean, in which a topic and a subject can occur simultaneously:

(8) a. khokkili-*ka* kho-*ka* kilta.

Elephant-S nose-S long- DEC

‘An elephant’s nose is long/ An elephant has a long nose.’

b. khokkili-*nun* kho-*ka* kilta.

Elephant-T nose-S long- DEC

‘As for an elephant, its nose is long.’

T: Topic marker; S: Subject marker; DEC: Declarative

3. Experiment

3.1. Research question

Is there a relationship between the English learners' Korean proficiency levels (i.e. "advanced" vs. "intermediate") and the use of topic-prominent features (i.e. zero anaphora, topic markers "n(un)," and double subject constructions) in L2 oral production tasks?

3.2. Hypotheses

Two different hypotheses can be formulated in relation to the two opposite claims described earlier in this paper:

Hypothesis A: If intermediate learners are not likely to transfer subject-prominent features to their Korean interlanguage and predominantly use topic-prominent features, it will support Fuller and Gundel's (1987) claim that topic-prominence is an early universal stage in L2 acquisition.

Hypothesis B: If intermediate learners tend to transfer subject-prominent features to their Korean interlanguage and if advanced learners show a decrease in the use of such subject-prominent features and an increase in the use of topic-prominent features, it will support the claim made by Heubner (1983), Rutherford (1983), and Schachter and Rutherford (1979).

3.3. Method

3.3.1. subjects

A total of sixteen adults including ten subjects (eight males and two females) and six interlocutors (three males and three females) participated in this study. Five advanced and five intermediate learners were drawn from Level II and Level III in a Korean curriculum at an American university, respectively. All the subjects were in their early 20's and were native speakers of English. Interlocutors were all native speakers of Korean, who were enrolled in the graduate programs at the same institution, whose age ranged from mid 20's to mid 30's.

3.3.2. procedures

When the subjects were recruited, each participant filled out a background questionnaire dealing with his or her personal information and Korean language education. The procedures of this study had two parts. In the first session, each subject watched a Charlie Chaplin's twenty-minute film, *Modern Times*, initially with his or her interlocutor. Then the interlocutor left the room while the subject continued to watch the remaining part of the film. The subject met up with his or

her interlocutor and was asked to retell the second half of the story (starting from the scene when Charlie Chaplin gets out of jail) to the interlocutor. This session was audio-taped. In the second part, two subjects discussed up to four topics among themselves, which was video-taped. In this session, the interlocutor played a role as a facilitator to smoothly introduce the discussion topics. The four topics were the following:

Topic 1

This is, a Charlie Chaplin movie of the silent film era. Chaplin is famous for being considered to be the best comedian of his time. Obviously people found him funny. I'm not sure I can quite see it that way. Based on this performance, would you consider him to be a great comedian? Why? Why not? Is this the kind of humor you are familiar with? Where are the similarities, where the differences?

Topic 2

We talked earlier how the movie ends with the young couple happily walking off into the sunset, the cliché of a Happy Ending in American movies. Is there anything particularly "American" about the brand of happiness the movie characters seem to aspire to? Does this kind of happiness also have appeal in Korean culture? Is there something like a "right to happiness" in American culture that contributes to the power of the cliché of a "happy ending" in American movies? How does that relate to the economic and political tensions of the time when the movie was made? What constitutes happiness today? How is it depicted in contemporary movies?

Topic 3

The whole notion of heroes changes over time. In the past heroism was often linked quite closely to combat and war, to physical accomplishments, but also to striving for impeccable ethical standards. What kinds of heroes does this movie show? What makes them people that set an example? What is problematic about that?

Topic 4

Chaplin is obviously the hero of the story, a hero of the little people. What makes him a hero in this story? What does that tell us about the needs or the aspirations of people at the time? Who are our heroes today, how do we depict them in movies, what does that say about major societal developments and concerns?

3.3.3. data analysis

The oral production data from each subject were separately analyzed with respect to the use of zero anaphora, topic marker "(n)un," and double subject constructions. Both quantitative and qualitative approaches were adopted to analyze the data: (a) calculation of the frequency with which the subjects used each topic-prominent feature in the oral production, in which Yates' correction factor was used for the statistical analysis; and (b) comparison of the actual utterances by

the advanced and the intermediate learners in each category.

The basic unit of analysis used in this analysis was a clausal unit adapted from Kim (1989)'s pear story narratives in Korean, which were originally used by Wallace Chafe (1980). In defining a clausal unit (Kim 1989: 432), the notion that "a verb with its arguments to which a conjunctive morpheme is attached" is important, in which a conjunctive morpheme signals clausal relations such as coordination, reason, condition, and so forth. In relation to a clausal unit, a sentential unit is defined as "a proposition which contains at least one sentence-final suffix (i.e. tense, aspect, and modality (TAM)) and is associated with arguments," and it is "a grammatical form which includes terminal suffixes which specify the speaker's assessment of the propositional content." The following example illustrates the relationship between the clausal unit and the sentential unit defined here:

- (9) a. ku yeca-ka ppang-ul hwumchy-ess-ki-ttaymwuney
 The woman-S bread-ACC steal-PAST-NOM-CONJ ('because')
 b. kyengchal-i ✗ cap-ass-ta.
 Policeman-S (the woman) arrest-PAST-DECL.
 'The policeman arrested the woman because she stole the bread.'

S: Subject marker; ACC: Accusative marker; CONJ: Conjunctive morpheme; DECL: Declarative; NOM: Nominalizer suffix; PAST: Past tense marker.

The above example (9) has one sentential unit, consisting of two clausal units. In (9a), a conjunctive morpheme "ttaymwuney" ('because') is attached to the verb "hwumchy-ess" ('stole'), signaling a reason relation, which marks the clausal boundary. "ta" in (9b) is a sentence-final suffix, and this marks the sentence boundary. Thus, the example (9) consists of one sentential unit, which is composed of two clausal units.

3.4. Results/ Discussion

3.4.1. zero anaphora

Results are discussed with respect to (a) zero anaphora, (b) topic marker "(n)un," and (c) double subject constructions in the oral production tasks. Table 1 presents the frequency of clauses with zero anaphora in the oral productions. The findings indicate that L2 proficiency appears to play a role in the production of clauses with zero anaphora. The advanced learners generally tended to omit subjects and objects more frequently than the intermediate learners. The advanced learners dropped noun phrases 47% of the time while the intermediate learners did so 44% of the time, although statistical significance was not found ($\chi^2 = 1.00$, $df = 1$; $p = n.s.$).

Table 1. Frequency of clauses with zero anaphora in oral production tasks

Groups	Advanced	Intermediate
<u>Clauses</u>		
No. of Zero Anaphora Clauses	183	154
% of Zero Anaphora Clauses	47%	44%
No. of Total Clauses	388	354

Furthermore, the advanced learners tended to drop subjects in sentences with reference to a current topic, whereas the intermediate learners tended to preserve subjects with subject case markers, a phenomenon due to the transfer of their L1, that is, one of the subject-prominent features that subjects are obligatory in a sentence.

A closer look at the use of zero anaphora by these learners reveals that, as Table 2 shows, there is a general tendency among these groups that learners tended to omit subjects far more frequently than they omitted objects. The advanced and the intermediate learners dropped subjects 91% and 97% of the time, respectively. The tendency that the subject noun phrases are far more frequently omitted than the object noun phrases was also observed in Korean L1 acquisition (Cho 1994; Kim 1998), L1 narrative study (Kim 1987), and other topic-prominent languages such as Chinese L1 (Cullen and Harlow 1986 cited in Cho 1994; Wang et al. 1992 cited in Cho 1994) and Chinese L2 studies (Jin 1994).

The asymmetry between subject- and object-drop in Korean might be accounted for by the From-Old-To-New Principle, according to which old, predictable information comes first, and new, unpredictable information comes last, in conjunction with the unmarked word order SOV in Korean (Kim 1998). Thus, it is natural to expect to see that subjects are more frequently omitted than objects are since the subject position tends to encode old ("established") information while the object position tends to represent new information.

Table 2. Subject- vs. Object- drop asymmetry in oral production tasks

Groups	Advanced	Intermediate
<u>Types of zero anaphora</u>		
Subject-drop	166 (91%)	150 (97%)
Objects-drop	17 (9%)	4 (3%)
Total	183 (100%)	154 (100%)

3.4. 2. use of topic marker "(n)un"

Table 3 displays the frequency of oral productions of clauses with topic markers "(n)un" by subjects in the tasks. It was found that the frequency of production of targeted form increased with learners' L2 proficiency. That is, the advanced

learners tended to topicalize sentences with a topic marker "(n)un" far more frequently than the intermediate learners. The advanced learners topicalized sentences 23% of the time while the intermediate learners did so 14% of the time, and the difference between these groups was found to be statistically significant ($\chi^2 = 9.61$, $df = 1$; $p < .01$).

Table 3. Frequency of topic-marked clauses in oral production tasks

Groups	Advanced	Intermediate
<u>Clauses</u>		
No. of Topic-marked Clauses	88	49
% of Topic-marked Clauses	23%	14%
No. of Total Clauses	388	354

In examining the syntactic categories that can be marked by a topic marker "(n)un" across groups, Table 4 shows that a noun phrase was most often marked by "(n)un," and a similar phenomenon was found in the use of a Japanese topic marker "wa" in Kuno (1978) and Nishimura (1989).

Table 4. Types of topicalized grammatical categories by topic marker "(n)un" in oral production tasks

Groups	Advanced	Intermediate
<u>Categories</u>		
NP	76 (86%)	43 (88%)
PP	7 (8%)	4 (8%)
Adv	5 (6%)	2 (4%)
Total	88 (100%)	49 (100%)

In addition, as Table 5 presents, both groups tended to use a topic marker "(n)un" to mark the subject noun phrase more frequently than the object noun phrase. The advanced and the intermediate learners used topic markers "(n)un" 88% and 95% of the time, respectively. The tendency to topicalize the subject noun phrases far more frequently than the object noun phrases parallels the use of Japanese topic marker "wa" in Nishimura's (1989) study on English-Japanese bilingual speakers, in which "wa" topicalized the subject noun phrases far more frequently than the object noun phrases. Hwang (1995) also found that irrespective of their functions within the clause, almost all the noun phrases marked by "(n)un" occurred in the sentence-initial position, which is consonant with the crosslinguistically attested fact that topics generally take place in the sentence-initial position (Li and Thompson 1976).

Table 5. Types of NP marked by topic marker "(n)un" in oral production tasks

Groups	Advanced	Intermediate
NP Types		
Subject	67 (88%)	41 (95%)
Object	9 (12%)	2 (5%)
Total	76 (100%)	43 (100%)

3.4.3. double subject constructions (DSCs)

Table 6 presents the frequency of clauses with double subject constructions used by these learners in oral production tasks. Consistent with the trends observed in their use of zero anaphora and topic markers "(n)un," learners were found to increase the use of double subject constructions as their proficiency increased: The advanced learners generally used more double subject constructions than the intermediate learners did. The advanced learners used double subject constructions 6% of the time, whereas the intermediate learners did so 1% of the time, whose difference was statistically significant ($\chi^2 = 14.99$, $df = 1$; $p < .001$).

Table 6. Frequency of clauses with DSCs in oral production tasks

Groups	Advanced	Intermediate
Clauses		
No. of DSC Clauses	24	3
% of DSC Clauses	6%	1%
No. of Total Clauses	388	354

4. Conclusion

The results of this pilot study can be summarized as: (a) The intermediate learners tended to transfer subject-prominent features such as preserving subjects of sentence to their Korean interlanguage, and the advanced learners tended to omit subjects and objects more frequently than their counterparts in the oral productions (47% vs. 41%), although statistical significance was not found ($\chi^2 = 1.00$, $df = 1$; $p = n.s.$); (b) The advanced learners tended to topicalize sentences with topic markers "(n)un" more frequently than the intermediate learners when introducing a known reference as a topic in the oral production tasks (23% vs. 14%). These tendencies were statistically significant ($\chi^2 = 9.61$, $df = 1$; $p < .01$); and (c) The advanced learners used more double subject constructions than the intermediate learners in the oral production tasks (6% vs. 1%), in which a statistical significance was found ($\chi^2 = 14.99$, $df = 1$; $p < .001$).

This study indicates that there was a general shift in the use of subject-prominent

to topic-prominent features in Korean L2 acquisition by English L1 learners according to their L2 proficiency levels: The intermediate learners tended to transfer subject-prominent features to their Korean interlanguage, while the advanced learners showed a decrease in the use of such features and used more topic-prominent features in the oral productions. The present findings are more consistent with the claim made by Heubner (1983), Rutherford (1983), and Schachter and Rutherford (1979), than the claim made by Fuller and Gundel (1987) regarding the early universal stage of topic-prominence in L2 acquisition, that learners in the early stage of learning tend to transfer their L1 features in L2 learning and that with increasing proficiency, learners gradually become sensitive to the characteristics of the target language, approximating to the target language norm.

This pilot study has attempted to expand the depth of research on the status of subject-prominent/ topic-prominent typology in L2 acquisition by investigating the interlanguage from the direction of subject-prominence L1 to topic-prominence L2, which has been studied relatively little so far. Given the small sample size, caution should be exercised in that the present findings cannot be generalized to a larger population. In order to more accurately observe the general pattern of developing topic-prominent features in L2 Korean, the present study should be supplemented by collecting not only more sufficient data from "intermediate" and "advanced" English learners of Korean but also data from beginning learners, as well as productions from native speakers of Korean as baseline data.

For future research, a longitudinal study should be carried out in order to examine the developmental sequences of topic-prominent features in Korean L2 acquisition by speakers of subject-prominent languages. It would also be interesting to compare the L2 acquisition of topic-prominent features in Korean between a naturalistic versus an instructed setting to see any possible effects of explicit formal instruction in helping learners to develop topic-prominence in their learning process. In addition, more studies need to be conducted on the native speakers of subject-prominent language learning the topic-prominent language as an L2 in order to verify whether the trends observed in the present study will be supported. Furthermore, research needs to investigate the acquisition of topic-prominent languages as an L2 by comparing learners from both topic-prominent and subject-prominent L1 backgrounds, which will enable us to gain a better understanding of the role of subject-prominent/topic-prominent typology in L2 acquisition.

References

- Bland, Susan 1981. "Topic comment sentences in English." *Cornell Working Papers in Linguistics*, 2, 32-49.
- Chafe, Wallace L. 1980. *The pear stories: Cognitive, cultural, and linguistic aspects of*

- narrative production*. Norwood, NJ: Ablex.
- Cho, Sook W. 1994. "The grammar of null arguments and mood categories in early child Korean." *Theoretical issues in Korean linguistics*, ed. by Young-Key Kim-Renaud. Center for the Study of Language and Information.
- Fuller, Judith W. and Jeanette K. Gundel. 1987. "Topic-prominence in interlanguage." *Language Learning*, **37**, 1: 1-17.
- Hwang, Myong O. 1983. "Topic continuity and discontinuity in Korean narrative." *Korean Linguistics*, **3**, 47-75.
- Heubner, Thomas. 1983. *A longitudinal analysis of the acquisition of English*. Ann Arbor, MI: Koronma Press.
- Jin, Hong G. 1994. "Topic-prominence and subject-prominence in L2 acquisition: Evidence of English-to-Chinese typological transfer." *Language Learning*, **44**, 1: 101-122.
- Kim, Haeyeon. 1987. "A discourse analysis of some conjunctive morphemes in Korean spoken narrative." M.A. thesis. University of California. Los Angeles.
- Kim, Haeyeon. 1989. "Nominal reference in discourse: Introducing and tracking referents in Korean spoken narratives." *Proceedings of Harvard workshop on Korean linguistics*, eds. by Susumu Kuno, et al. Hanshin Publishing Company, Seoul, Korea.
- Kim, Young J. 1998. "The acquisition of Korean." Unpublished manuscript. Hong-ik University, Seoul, Korea.
- Kim, Young J. 1998. "The acquisition of Korean." *The crosslinguistic study of language acquisition*, ed. by Dan I. Slobin, 336-444. Lawrence Erlbaum Associates.
- Kuno, Susumu. 1978. *The structure of the Japanese language*. Cambridge, MA: MIT Press.
- Li, Charles and Sandra Thompson. 1976. "Subject and topic: a new typology of language." *Subject and topic*, ed. by Charles Li, 457-489. New York: Academic Press.
- Nishimura, Miwa. 1989. "The topic-comment construction in Japanese-English code-switching." *World Englishes*, **8**, 3: 365-377.
- Rutherford, William. 1983. "Language typology and language transfer." *Language transfer in language learning*, eds. by Susan Gass and Larry Selinker, 358-470. Rowley, MA: Newbury House.
- Schachter, Jacquelyn and William Rutherford. 1979. "Discourse function and language transfer." *Working Papers on Bilingualism*, **19**, 1-12.

A Two-Root Theory of Korean Geminate Consonants*

Eon-Suk Ko

University of Pennsylvania

Since the proposal of an autosegmental CV tier by McCarthy (1979), there have been debates regarding how to represent the length of segments to properly capture relevant phonological phenomena that are length-sensitive. Central among the different standpoints regarding this issue is the treatment of geminates. There have been largely two standard viewpoints of representing geminates: earlier versions of autosegmental phonology assume that the quantity of a segment is represented as a single melody unit linked on a skeletal tier composed of so-called timing units such as C's and V's, or simply X's. More recently, McCarthy and Prince (1986) and Hayes (1989) have contended that the skeleta of templatic morphology are solely composed of prosodic constituents such as foot, syllable and mora, but no use is made of a skeletal tier composed of C, V, or X.

Parallel to the development of the theories of skeleton, there has also been a development of the theories of feature structure. In earlier versions of autosegmental phonology, the feature content of a segment was represented on a melody tier as a simple distinctive feature matrix. However, it is now generally assumed that features are organized into a structured representation called feature geometry (Clements 1985). Although there are different opinions as to the detailed structure of the feature geometry, what is generally assumed is that a *root node* dominates all other features that specify a segment.

Putting together the theoretical development of featural representation and prosodic structure, Selkirk (1990) proposes a two-root theory of length. She basically accepts the McCarthy-Prince notion of the skeleton as constituted, in its lower reaches, by a syllable and mora structure, and lacking any representation of a skeletal tier. Incorporating the feature structure of Clements (1985), the root tier is the interface between feature structure and the prosodic

* I thank Gene Buckley and Rolf Noyer for helpful discussions on this issue. However, I alone am responsible for the arguments made in this paper and any remaining errors .

structure of the skeleton. Now, the arising question is how to represent the length in such framework.

Many of the proponents of moraic theory assume a one-root theory of length as follows:

(1) One-Root Theory of Length

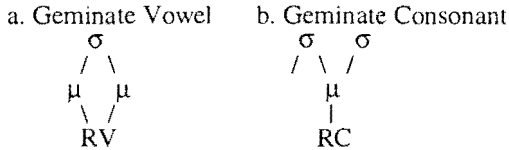

As in the above lexical representation (1b), geminate consonants consist of a single root node linked to a single mora, and the double-linking is produced by general rules of syllabification.

Alternatively, Selkirk (1990) contends that geminate entities involve two identical root nodes and some amount of shared feature specifications, including shared features for Place:

(2) Two-Root Theory of Length

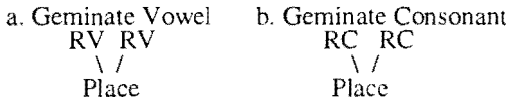

In her representation, full geminates involve sharing of all features whereas partial geminates are structures where specifications for laryngeal features or nasality may differ in the two halves.

In this paper, adopting Selkirk's two-root theory of geminates, I will give an analysis of some geminate-related phonological phenomena in Korean. In section 1, I will briefly review the debates on the representation of the Korean tense consonant and will propose to see it a geminate. In section 2, I will go over some arguments of Selkirk in support of the two-root theory of length, and will apply it in explaining Korean degemination and post obstruent tensing. In section 3, the two-root theory of Korean fortis consonants will be strengthened with a more elaborated theory of the moraic tier in Korean. An account of /h/ related phonological phenomena will also be given. In section 4, I conclude that a two-root theory is better in representing the geminates and the separation of weight from length.

1. Korean Fortis Consonant

Korean obstruents show a three-way laryngeal surface contrast between plain, aspirated and tense. There have been two opposite views regarding proper representation of the underlying distinctiveness among these consonants. While many assume that Korean has a three-way underlying phonation contrast (Kim-Renaud 1974, Cho and Inkelas 1994, etc.), there also have been attempts to reduce the contrast to a binary one (Han 1992, Jun 1995, etc.).

Most works that assume the Korean tense consonant as singleton represent its distinctive laryngeal status with the [+constricted glottis] feature. However, in a cineradiographic study of Korean consonants, Kim (1970) provides a persuasive argument that the Korean tense consonant should not be treated as a glottalized consonant which involves an ejective aerodynamic mechanism in its pronunciation.

One of the strongest phonological arguments against the geminate analysis of the Korean tense consonant has been that it violates Korean syllable structure, which does not allow a consonant cluster in an onset. However, this constraint is a byproduct of the C/V or X theory. If we shift our representational theory to the system that does away with the timing slots, the only restriction on the onset position will be that it should be nonmoraic. As will be discussed in later sections, I assume that only sonorant geminates are moraic in Korean. Therefore, the existence of an obstruent geminate onset is no longer a problem. Under such a mora-based restriction on the distribution of onset, the absence of sonorant geminates in the onset position won't be a mere coincidence if it is moraic as will be argued in section 3.

Among the arguments for the geminate analysis of Korean tense consonants have been the following:

(3) Geminate Analysis of Korean Tense Consonants (Han 1992)¹

- a. morphological gemination: morphological tensification happens in co-compounds. Since sonorant consonants involve gemination in the same environment, tensification of obstruents can also be seen as gemination.

- i) /i + mom/ → [immom] 'tooth + body → gum'
 ii) /so + caŋ/ → [soc'aŋ] 'call + paper → subphoena'

- b. surface fake geminates are phonetically identical to tense consonants

- i) /tok + ki/ → [tok'i] 'poison + temper → vice'
 ii) /tok'i/ → [tok'i] 'ax'

¹ I have not listed other evidence that is not phonologically very interesting among her proposals.

Besides the above, there is also convincing acoustic evidence that the Korean tense consonant is geminate. That is, two of the important phonetic cues for the Korean tense consonant is its long closure duration intervocally and its strong burst at the onset of voicing, which is also a typical phonetic cue for geminates cross-linguistically (Hume et al. 1997).

Based on the above, I will assume that the Korean tense consonant is a geminate and will give an analysis of some phonological phenomena involving Korean tense consonants based on this assumption. It will be shown that tense consonants related phenomena are best explained by the geminate analysis of tense consonants with two-root theory.

2. The Two-Root Theory of Length

Having defined the Korean tense consonant as a geminate, I will argue that its length is best represented using the framework of the two-root theory proposed by Selkirk (1990). In the following subsections, I will first go over some data and arguments supporting the two-root theory of length from Klamath. Then I will look at post-obstruent tensification from Korean and argue that it is best explained using the two-root theory, being the kind of rules that affect the feature content of just one half of a geminate.

2.1 Laryngeals in Klamath and Icelandic (Selkirk 1990)

The first argument for a two-root theory of length can be found in Steriade (1987a), where she presents evidence for the existence of rules which modify only half of a geminate. The following is an example which Selkirk names *laryngeal fission*.

In Klamath, obstruents are phonemically voiceless [p, t, c, k, q], voiced [b, d, j, g, G], and glottalized [p', t', c', k', q']. Within the rime, however, this distinction is neutralized. Selkirk proposes the following rule for this explanation:

(4) Klamath Laryngeal Neutralization

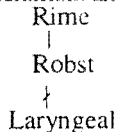

It is assumed that a default rule later fills in the voiceless plain value observed in this position.

When the rule applies to a heterosyllabic obstruent, it will produce a derivation like the following:

(5) Klamath Laryngeal Fission: Nongeminate Obstruent Clusters

/p'k/ → [pk], /dk'/ → [tk']

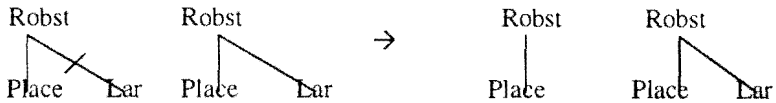

Interestingly, the neutralization rule affects the first half of geminate consonants, too.

(7) Klamath Laryngeal Fission: Geminate Obstruent Clusters

/p'p'/ → [pp'], /dd'/ → [td]

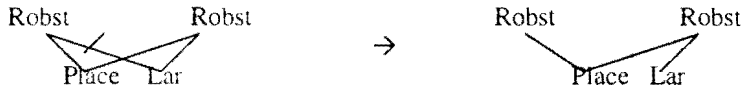

In the above example, the first half of the geminate is neutralized and by default changed into a voiceless. In the proposed two-root analysis, each root node is separately specified for laryngeal features.

In an alternative one-root theory of the geminate, the dual laryngeal specifications should be assigned to a single root node.

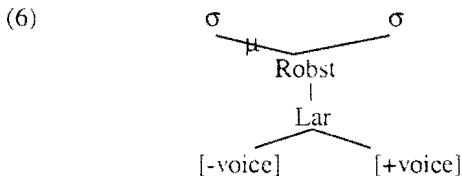

In this approach, however, the problem of proper ordering of features arises. Drawing arguments from Sagey (1986) and Lombardi (1989), Selkirk argues that there is no independent basis for assuming that an ordering of feature specification is possible under the root node (i.e. *No-Feature-Ordering Generalization*). This problem could be obviated if universal principles could be called on to guarantee the proper ordering of the two laryngeal specifications in geminate obstruents (Kingston 1986). However, Selkirk points out that we are still left with the necessity of seeing the ordering of the laryngeal features in geminates and nongeminates in different terms, which is really the essential drawback.

Selkirk also gives an explanation of Icelandic preaspiration in terms of two-root theory. Icelandic preaspiration involves the delinking of aspiration from an underlying aspirated stop and a transfer of that aspiration to the preceding consonantal segment. Readers are referred to her original analysis due to space limitations, but the essential point is that a two-root representation of geminate stops permits preaspiration in geminates to be subsumed under the more general phenomenon of preaspiration in consonant clusters. With one-root theory of geminates, however, it becomes a mystery why geminates should pattern with consonant sequences. This point will be repeated with other similar phenomena from Korean in following sections.

2.2 Post Obstruent Tensification in Korean

In Korean, there are several sources for the so-called 'tense' consonants. For example, the following /k/ʼs are identically realized as [kʰ]² at the phonetic level:

- (7) a. /tokki/ → [tokʰi] 'ax'
 b. /tok+ki/ → [tokʰi] 'poison + temper = vice'
 c. /top-ki/ → [topkʰi] 'help-nm'

(7a) is an underived word, while (7b) and (7c) are each derived by compounding and nominalization.

Proponents of the singleton analysis of tense consonants have argued that the tense *kk* [kʰ] in (7a) is underlyingly a singleton specified with a [+cg] feature, while the ones in (7b) and (7c) are derived by the following rule of Post Obstruent Tensification:

(8) Post Obstruent Tensification (Cho and Inkelas 1994)

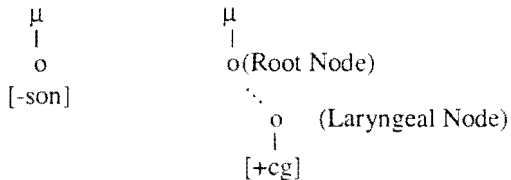

Cho and Inkelas argue that the above rule faces a paradox if applied to geminates:

² Throughout the paper, this notation does not commit itself to any lexical status of the tense consonants but is used as a shorthand for representing phonetic 'tense'ness.

(9) Geminate

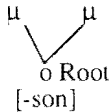

According to the Linking Constraint (LC, Hayes 1986), which interprets the association lines of a rule exhaustively, the POT rule (8) cannot apply to the geminate with the configuration as (9). Thus the LC incorrectly predicts no tensification of a geminate. Also, according to the Uniform Applicability Condition (UAC, Schein and Steriade 1986), it is not possible to insert the [+cg] feature only to the second half of a geminate. Therefore, UAC will also incorrectly block the tensification of geminate. Based on this line of argument, Cho and Inkelas contend to abandon the geminate hypothesis of Korean tense consonants rather than abandoning the LC and the UAC.

Note, however, that in the representational system of the two-root theory, the problems associated with the LC and the UAC do not arise. Since the representation has two linking lines under each Root node, the violation of the LC will not arise. Also, UAC is no longer a problem since one of the main advantages of the two-root theory was exactly aimed at this—altering featural content of only half of the geminate.

(10) Geminate in Two-root Theory



Thus, as in the Icelandic preaspiration case, a two-root representation of the tense consonant seems to permit the tensification of geminates to be subsumed under the more general phenomenon of POT.

However, the above paragraph which entails a possibility of analyzing the tensing of geminate and the POT as a unified phenomenon has a serious logical paradox. Recall that, adopting the two-root theory of Korean tense consonants, we decided to get rid of the [+cg] feature in Korean phonology since what makes the geminate sound 'tense' is not any featural specification under the laryngeal node at the underlying level, but a phonetic implementation. We cited Kim (1970) to support our intuition that [+cg] is not really a proper feature to represent the 'tenseness' of Korean tense consonants. Therefore, the POT analysis of geminate reinforcement which assumes an insertion of the [+cg] feature to the latter half of the geminate is not a viable analysis. The same is true with the POT of obstruent clusters.

If there is no [+cg] feature in Korean phonology, then, we are forced to come up with a new analysis of the POT that does not involve an insertion of the [+cg] feature. The 'tenseness' of underlying geminate consonants and the result of

POT seem to be at least an identical phonetic entity: they are indistinguishable both acoustically and perceptually (Han 1996). Then one possibility would be to think of the POT as a gemination process rather than tensification: in other words, we shift our focus from the featural specification to the segmental tier.

I suggest that the POT be seen as a Post Obstruent Gemination whereby the features of the right hand side obstruent spreads to the root node on its left in a concatenation of two obstruents, whether they be geminate or not.

- (11) Post Obstruent Gemination (phonological gemination³)

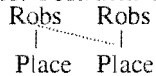

For example, in the obstruent sequence /ks/ in the following example, /s/ ends up with two root nodes via the gemination rule (11).

- (12) /c^hæksaŋ/ → [c^hæks'aŋ] 'desk'

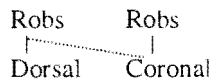

Once the features of the obstruent /s/ is linked to two root nodes, the way it gets 'tense' is by phonetic implementation as in the case of underlying geminates.

3. Moraic Theory of Korean Consonants

In this section, we will turn our attention to the moraic tier to explain some phonological phenomena that are hard to explain at the segmental level.

As mentioned before, the lexical representation of a two-root theory itself does not make any commitment as to the status of geminate vowels and consonants in a syllable/mora structure. The moraicification and syllabification of geminates is presumed to be accomplished by general principles and rules in the grammars of individual languages, and, therefore, the moraic status of geminates may vary from one language to another. In this way, two-root theory makes potentially different predictions from one-root theory (Selkirk 1990).

In the following subsections, I will examine the moraic status of Korean geminates with two phonological phenomena: degemination (3.1) and umlaut (3.2). Then I will also take a look at the moraic status of aspirated consonants in 3.3.

³ There is also a corresponding morphological gemination process in cocompounds as we've seen in section 1. It applies to both sonorants and obstruents, unifying the source of the 'tensing' from phonology and morphology.

3.1. Umlaut

Lee (1993, cited in Tak&Davis 1994) argues that umlaut occurs only when the target and trigger are moraically adjacent.⁴ In the following, we see that umlaut occurs across a singleton consonant as in (13a), but does not occur across a geminate as in (13b). Interestingly, umlaut is not blocked for the tense consonants as in (13c), nor across consonant clusters as in (13d).

(13) Umlaut

a. /talimi/	→ [tærimi]	'iron'
/mæki/	→ [meki]	'food'
b. /all-i-/	→ [alli] (*[ælli])	'notify'
/t'əli-i-/	→ [t'əlli] (*[t'elli])	'tremble'
c. /ak'i-/	→ [æk'i]	'dear'
/t ^h ök'i/	→ [t ^h ök'i]	'rabbit'
d. /nampi/	→ [næmbi]	'pot'
/an-ki-/	→ [æŋgi]	'be hugged'

These data are interesting in two respects. First, tense consonants in (13c) pattern with the singletons as in (13a) rather than the sonorant geminates in (13b). Meanwhile, they also pattern with the consonant clusters in (13d) rather than the sonorant geminates in (13b). Their patterning with both the singleton and consonant clusters appears to be paradoxical.

In a one-root theory of length, it becomes a mystery why geminates pattern with consonant clusters. However, in the two-root representational system of geminate combined with a language specific moraic projection theory, these data can be nicely explained. The following are illustrations of each of the four cases (13a)-(13d):

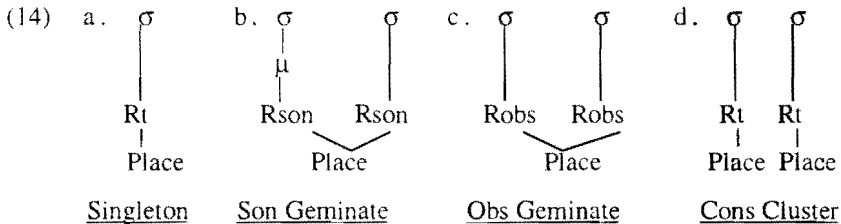

⁴ A better explanation for umlaut blocking could be found in the secondary articulation of the intervening consonant. Namely, the reason umlaut is blocked in 'alli-' and 'mati' is probably because of the palatalization of [l] and [t] (Hong 1997). However, since Lee's explanation nicely fits with the analysis of degemination, I will accept his analysis for now.

With the the representational system as above, moraic adjacency of some of the examples are represented as follows:

- (15) a. μ μ b. $\mu\mu$ μ c. μ μ d. μ μ
 a . k i a i . l i a k . k i n a m . p i

In the above illustration, we can see that the moraic tier plays a crucial role and that umlaut is blocked in (15b) because /a/ and /i/ are not adjacent in moraic tier.

What the data of umlaut above shows us is that the weight (i.e. mora) and length do not necessarily coincide, but they could be separated from each other.⁵

3.2. Degemination

In Korean, certain suffixes impose prosodic requirements on stems to which they attach. One such case is degemination which occurs when the suffix /-ini/ attaches to a monosyllabic stem.

- (16) Degemination in Korean (data adapted from Tak & Davis 1994⁶)
- | | | | |
|----|------------|-------------|------------------|
| a. | /sak-ini/ | → [sakini] | 'decomposed-sfx' |
| | /s'ip-ini/ | → [s'ipini] | 'chew-sfx' |
| b. | /coll-ini/ | → [corini] | 'nag-sfx' |
| | /kəll-ini/ | → [kəriini] | 'filter-sfx' |
| | /null-ini/ | → [nurini] | 'press-sfx' |
| c. | /tak'-ini/ | → [tak'ini] | 'wipe-sfx' |
| | /sək'-ini/ | → [sək'ini] | 'mix-sfx' |
| | /pok'-ini/ | → [pok'ini] | 'fry-sfx' |

The above examples illustrate that when a stem ending in a geminate /l/ is followed by the suffix /-ini/, it is degeminated (16b). If the obstruent tense consonants in (16c) are also geminate, then, we would expect the application of degemination there, too. However, on the contrary, we find that they pattern with the singletons as in (16a) rather than the sonorant geminates in (16b).

There are logically two possibilities to get around this problem. First, we could simply abandon the geminate hypothesis of the tense consonant and go back to the singleton analysis of it. However, since we have already seen convincing arguments for the geminate analysis of the tense consonant in section 2.2, this is not an attractive option. Alternatively, we could solve this

⁵ Further data illustrating the separation of weight and length can be found in Leti (Hume et al. 1997) and Trukese (Hart 1991).

⁶ Tak & Davis (1994) uses this phenomena to argue that the Korean tense consonant is a non-moraic singleton. In my analysis, they are still geminates, despite being non-moraic.

problem by turning to the representation of the moraic tier as in the previous section 3.1.

Following the moraic status of geminates as has been established in the previous section with umlaut, we could say that degemination applies only to moraic geminates, but not to nonmoraic geminates such as obstruent geminates. This could be more properly called, then, 'demoraification' and formally represented like the following:

(17) Demoraification

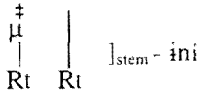

Since it is only half of the geminate that is deleted, this phenomenon supports the two-root theory of geminate.

There might have to be an additional constraint, like the following, which prevents the floated root node from being linked to the following syllable.

(18) Constraint

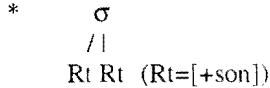

Note that this constraint independently captures the fact that there is no sonorant geminate in onset position in Korean.

If geminates are represented in a one-root theory, the above explanation will face a problem. Given the moraic status of the sonorant and obstruent geminates assumed here, the representation of singletons and geminates in a one-root theory would be as follows:

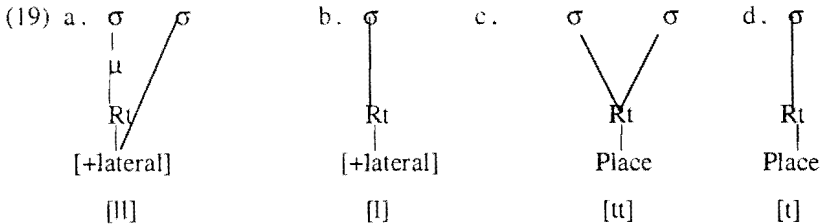

In the above representation (19c), obstruent geminate appears as ambisyllabic in contrast to the singleton. However, Suh (1993) has argued that ambisyllabicity should be considered separately from geminates since Korean exhibit a case where singleton should be represented as ambisyllabic. His

argument is based on the following data of delateralization in syllable onset position:

- (20) Delateralization in Korean
- | | | |
|----------------|---------------|---------------------|
| a. /lakwən/ | → [nakwən] | 'paradise' |
| b. /sillakwən/ | → [sillakwən] | 'paradise lost' |
| c. /poklakwən/ | → [poŋnakwən] | 'paradise regained' |
| d. /soli/ | → [sori] | 'sound' |

His argument, in a nutshell, is that delateralization is blocked in (20b) and (20d) because they do not meet the structural description of the rule. Crucially, (20b) is explained best when treated as ambisyllabic.

Thus, with two-root representations of the singletons and geminate as in (14), we can save the argument of Suh (1993) for explaining delateralization as well as explaining other phonological phenomena.

As articulated by McCarthy & Prince (1986), one-root theory is a moraic theory of length; in lexical representation, long segments consist of a single root node linked to a single mora. However, the lexical representation of two-root theory does not make any commitment as to the status of geminate vowel and consonants in a syllable/mora structure. We have seen that this is an advantage of the representation system of the two-root theory which gives us the richness of a representational system to accommodate various sorts of relation between length and weight.

Note that one-root and two-root theories are couched within a representational system that does away with the X-tier. From the point of view of the theory of phonological representation, two-root theory could be seen as a revision of the early autosegmental theory where features of the melody are associated to two positions in a C/V or X tier. What distinguishes the conception of the root tier from the conception of C/V or X tier is that root nodes are understood to be part and parcel of the feature organization of the representation. On this view, the C/V tier is a proto-root tier, and properly belongs to feature structure (Selkirk 1990). Therefore, unlike in Clements (1985), it is not a well-formed representation to link the root node to the timing tier again. For example, it is not possible to doubly link a root node to two timing slots.

So far, we have seen that the umlaut and degemination phenomena can be well explained with a combined theory of two-root and moraic tier. In the following section, we will look at another mora-related phenomena from aspirated consonants of Korean.

3.3 Moraic phonology of Korean /h/ and aspirated consonants

This section is not directly related to the central issue of this paper, i.e. one-root vs. two-root theory of geminates. However, to give a full theory of moraic scale

in Korean consonantal phonology, I will illustrate some additional data involving /h/.

Compensatory lengthening has served as a good indication of the existence of the moraic tier in each language. In the following data, we see that instead of the deleted /h/, the vacancy can be filled in by a default vowel /i/ or by spreading the following consonant /n/.

(21) Compensatory Lengthening

- a. /olh-ni/ → [olini] 'be right-Q'
 b. /noh-ni/ → [nonni] 'put-Q'

Although the above could also be represented in a X-tier theory, Hayes (1989) argues that moraic structure permits a more natural account of the compensatory lengthening process, which occurs mostly when something in the rime is deleted.

On the assumption that /h/ is moraic in Korean as is seen in the compensatory lengthening fact in (21), we can now ask what the moraic status of an aspirated consonant is. The following data show some /h/ related phonotactic facts:

- (22) a. /coh-ta/ → [cot^ha] 'good-ending'
 b. /coh-ni/ → [conni] 'good-Q'
 c. /coh-so/ → [cosso] 'good-ending'

First, note that under one-root theory of Korean tense consonants, the data (22c) has been a problem since, although the phonetic realization seems to conform to the POT, the triggering segment /h/ has never satisfactorily reached a unanimous agreement that it is an obstruent. However, by attributing the 'tenseness' to the phonetic implementation of the obstruent geminate as suggested by the phonological gemination rule (11), (22c) can get a natural account by spreading the features of /s/ under the root node of /h/.

To illustrate, let us assume that the onset spreads to the root node of /h/ and vice versa at a morphological boundary.

- (23) a.
$$\begin{array}{c} \mu \\ | \\ \text{Rt}]_{\sigma} \quad \text{Rt} \\ | \quad \diagdown \quad | \\ \text{Lar} \quad \text{Place} \end{array}$$
 b.
$$\begin{array}{c} \mu \\ | \\ \text{Rt}]_{\sigma} \quad \text{Rt} \\ | \quad \text{---} \quad | \\ \text{Lar} \quad \text{Place} \end{array}$$

(23a) illustrates the process happening in (22a) and (22c), and (23b) illustrates the one in (22b). In (23a), laryngeal feature can be licensed by the onset of the following syllable and it survives to the surface realization. However, in (23b),

since /n/ cannot have a laryngeal node, it cannot be licensed by the onset of the following syllable, and deletes.

Note that one consequence of the above explanation is that derived aspirated consonant /h/ and geminates such as /ss/ and /nn/ are now moraic. This seems to be true when we see the following data:

- (24) a. /noh-ki/ → [nok^hi] *[nök^hi] 'put-nml'
 /nah-ci/ → [nac^hi] *[næc^hi] 'bear-conj'
 b. /cap-hi/ → [cæp^hi] 'catch-passive'
 /cæc-hi/ → [cec^hi] 'push-causative'

Although phonetically identical, the derivational process of the aspirated consonants are different in the data (24a) and (24b). Namely, the aspirated consonants in (24a) are derived by the process in (23a), where the underlying mora of the coda /h/ is inherited by the output consonant. However, the aspirated consonants in (24b) are nonmoraic since their aspiration comes from a nonmoraic /h/ in the onset position, as illustrated in the following (25):

- (25) Rt]_o Rt
 [>>>]
 Place Lar

To sum the discussion of this section, the following have been argued to be moraic in Korean:

- (26) vowel, sonorant geminate, /h/, derived aspirate and geminate consonants involving moraic /h/

4. Conclusion

In this paper we have seen several phonological phenomena that are problematic when represented with a system that is solely dependent on the length of the segments, such as C/V or X theory, or on the weight of the segments, such as the one-root version of the moraic. Using the two-root theory of length by Selkirk (1990), which leaves the moraicification and syllabification of geminate open to be accomplished by general principles and rules in the grammars of individual languages, I have shown that such phonological phenomena can be nicely explained without a further costly complication of the representational system. Specifically, I have argued that Korean tense consonants should be seen as underlyingly nonmoraic geminates, whose phonetic implementation is achieved by a general rule of post-obstruent

tensification. Such a representational definition of Korean tense consonants as has been applied in explaining umlaut and degemination of Korean is expected to further clarify other phonological phenomena that involve either length or weight or both.

References

- Cho, Y-M, and S. Inkelas. 1994. "Post obstruent tensification in Korean and geminate inalterability", in Kim-Renaud (ed), *Theoretical Issues in Korean Linguistics*, CSLI
- Clements, G. 1985. "The geometry of phonological features", *Phonology* 2: 223-250
- Han, J-I. 1992. "On the Korean Tense Consonants and Tensification", *CLS* 28: 206-223
- Han, J-I. 1996. *The Phonetics and Phonology of 'Tense' and 'Plain' Consonants in Korean*, Cornell dissertation
- Hart, M. 1991. "The moraic status of initial geminates in Trukese", *BLS* 17
- Hayes, B. 1986. "Inalterability in CV phonology", *Lg* 62, 3221-251
- Hayes, B. 1989. "Compensatory lengthening in moraic phonology", *LI* 20.2
- Hong, S-H. 1997. "Palatalization and umlaut in Korean", *UPenn Working Papers in Linguistics* 4.3: 87-133
- Hume, E, M. Jennifer, and A. Engelenhoven. 1998. "Nonmoraic geminates in Leti", *Phonology* 15
- Jun, J. 1994. "Metrical weight consistency in Korean partial reduplication", *Phonology* 11.1: 69-88
- Kim, C. 1970. "A theory of aspiration", *Phonetica* 21: 107-116
- Kim-Renaud, Y-K. 1974. *Korean consonantal phonology*, UHawaii doctoral dissertation
- Kingston, J. 1986. *The Phonetics and Phonology of Timing of Oral and Glottal Events*, UC Berkeley dissertation
- Lee, Y-S. 1993. *Topics in the Vowel Phonology in Korean*, Ph.D. Dissertation, Indiana University
- Lombardi, L. 1990. "The nonlinear organization of the affricate", *NLLT* 8.3: 375-425
- McCarthy, J. 1979. *Formal Problems in Semitic Phonology and Morphology*, Garland, NY
- McCarthy, J and A. Prince. 1986. "Prosodic morphology", ms., Brandeis University
- Sagey, E. 1986. *The Representation of Feature and Relation in Nonlinear phonology*, MIT doctoral dissertation
- Schein, B. and D.. Steriade. 1986. "On geminates.", *LI* 17: 691-744
- Selkirk, E. 1990. "A two-root theory of length", *UMOP* 14
- Suh, C-K. 1993. "Ambisyllabicity in Korean: evidence from *Melisoli Kyuchik* (Word-initial Avoidance)", *Harvard Studies in Korean Linguistics*, Hanshin, Seoul
- Tak, J. and S. Davis. 1994. "A reanalysis of Korean tense consonants", *CLS* 30: 405-417

Eon-Suk Ko
 Department of Linguistics
 619 Williams Hall
 University of Pennsylvania
 Philadelphia, PA 19104
 esko@ling.upenn.edu

Audible Silence: Silent Moras in Japanese Verse*

Kumi Kogure, Mizuki Miyashita
University of Arizona

1 Introduction

Most metrical analyses rely on the stress systems of a language (Hanson and Kiparsky 1996), and some (Fitzgerald, 1995, 1997, Golston to appear) are analyzed in terms of Optimality Theory (OT, McCarthy and Prince 1993, Prince and Smolensky 1993). This paper also deals with Japanese verse in the framework of OT. There are three goals and points in this paper. Our first goal is to describe the data concerning moras in Japanese verse, specifically in the haiku poetry of Kobayashi Issa (1763 - 1827), a renowned poet in Japan. Our second goal is to account for native speakers' intuitions regarding pause positions in haiku in terms of OT. Third, we show that the analysis of Japanese verse requires the notion of an empty mora (Carter 1996, 1998) as well as non-headed moraic binary feet (Poser 1990, Kozasa 1997).

The organization of this paper is as follows. We give background on the mora in Japanese verse, specifically haiku. Then, we show the data and generalizations that can be made about the location of pauses in haiku poetry. We explain our analysis, followed by a conclusion.

2 Background

In this section, we provide background in order to better describe our data and to lay the groundwork for the analysis which follows. A description of Japanese moras and the basic structure of haiku poetry, as well as a discussion of the significance of pauses in haiku recitation are described in the following subsections.

2.1 The mora in Japanese

A mora is an abstract unit in phonology. A syllable in Japanese may have either one or two moras. A monomoraic word (or syllable) such as *te*, as shown in

(1a), has one short vowel. A bimoraic or heavy syllable is as in *ten* or *tee* in *teepu*, having either a long vowel or a coda consonant.

(1)

- | | | | |
|-----|------------|----------|--------|
| (a) | one mora: | .te. | 'hand' |
| (b) | two moras: | .ten. | 'dot' |
| | | .tee.pu. | 'tape' |

Also, native speakers intuitively consider that the temporal distance between moras is equal; that is, that moras are of equal length. Recitation of haiku reveals this fact more robustly than in normal speech.

2.2 Basic structure of haiku

Next, let us introduce the basic structure of a haiku. A haiku consists of three lines, each line having a fixed number of moras. The first line has five moras, the second line seven moras, and the third line has five moras. An example haiku is given in (2). Please note that a mora is indicated by a μ .

(2) Haiku by Kobayashi Issa

ya se ga e ru (5 moras) 'skinny frog'
 $\mu \mu \mu \mu \mu$

ma ke ru na Is sa (7 moras) 'do not lose'
 $\mu \mu \mu \mu \mu \mu \mu$

ko re ni a ri (5 moras) 'I (Issa) am here'
 $\mu \mu \mu \mu \mu$

The first line has five moras (*ya, se, ga, e, ru*), the second line has seven moras (*ma, ke, ru, na, i, s, sa*), and the third line has five moras (*ko, re, ni, a, ri*). This string of three lines which consist of five-seven-five moras is the basic structure of a haiku verse.

2.3 Pauses are inserted in each line

For a haiku recitation, pauses are inserted in each line. Bekku (1977) claims that each line has a relatively equal length in time, resulting in eight-moraic beats for every line. Kawakami (1973) also reports that this is true, based on the results of his experiments. Therefore, the gap between the eight-moraic template and the actual number of moras in a line (five or seven) is filled with the appropriate number of pauses. The length of one pause is the same as that of a mora. Therefore, we treat a pause that is inserted in a verse line as an empty mora

(Carter 1996, 1998). Our analysis, given in following sections, assumes the existence of an empty mora.

The following is the same haiku as in (2), with an indication of the pauses in each line. A pause is indicated by a hand sign: ✎.

- (3) Issa ✎ = a pause
- line 1: 5 moras + 3 pauses = 8 beats
 ya se ga e ru ✎ ✎ ✎ 'skinny frog'
 μ μ μ μ μ μ μ μ
 - line 2: 7 moras + 1 pause = 8 beats
 ma ke ru na Is sa ✎ 'do not lose'
 μ μ μ μ μ μ μ μ
 - line 3: 5 moras + 3 pauses = 8 beats
 ko ko ni a ri ✎ ✎ ✎ 'I am here'
 μ μ μ μ μ μ μ μ

Although the second line of the haiku in (3) has a pause at the end of the line, the position of the second-line pause varies haiku by haiku. It is either at the front, middle or end of the line. A native speaker knows intuitively where to put a pause when s/he encounters a new haiku. It is predictable based on the structure of the haiku.

Our focus for this paper is to look at the second lines of haiku since they show interesting variations in pause-position: they are front-, middle-, or end-pause patterns. However, we focus specifically on the front- and end-pause patterns, because many cases of the middle-pause pattern are caused by prescriptive rules. Our data is introduced in the following section.

3 Data and generalization

In this section, we describe the notation we use in this paper. Then we outline generalizations of the data in the section 3.2.

3.1 Introduction of the data and notation

We examined over two hundred haiku by Kobayashi Issa (Raboku 1929, Kobayashi 1997).¹ We looked for lines that consisted of two words, which is very common, and we divided haiku depending on the location of word breaks.² For example, there are lines that consist of two words, with the first word having two moras, and the second word having five moras, and so on. Types of word boundaries are shown in (4) below.

(4) Word boundaries represented by < >; μ stands for mora.

2-5 < μ μ >< μ μ μ μ μ >

5-2 < μ μ μ μ μ >< μ μ >

3-4 < μ μ μ >< μ μ μ μ >

4-3 < μ μ μ μ >< μ μ μ >

We also looked at syllable weight and considered whether the position of a heavy syllable would make any difference in pause location. Again, a word boundary is indicated by angle brackets, and a syllable boundary is indicated by dots.

(5) Notation: word boundary < μ μ >;
 syllable boundary . μ . μ μ . μ . μ .
 (e.g: .light.heavy.light.light.)

In the following section, the data are shown. The first examples of haiku (second lines only) are lines consisting only of light syllables. The rest of the data are lines with one heavy syllable. All lines are shown using the same method of notation.

3.2 Light syllables

Let us examine light-syllable lines first.

(6) Light syllables

(a) 2-5: end pause

<.hi.to.><.u.ra.ya.ma.shi.>☞ 'envious of a person'

(b) 3-4: front pause

☞<.gu.sha.mo.><.tsu.ki.yo.mo.> 'foolish, on this moonlit night'

(c) 4-3: end pause

<.ne.zu.mi.mo.><.na.me.ru.>☞ 'a rat is slowly drinking'

(d) 5-2: end pause

<.i.ri.do.do.ro.><.ra.ri.>☞ 'place where sun sets'





The first example line in (6a) shows a second line that consists of light syllables only. Also, the line has two words. The first word, *hito*, has two moras, and the second word, *urayamashi*, has five moras. These numbers are shown as the number indicated above the line (2-5), and we call it the 2-5 case. In this case, the pause is placed at the end of the line.

The next case is in (6b). The first word has three moras, and the second word has four moras. In this 3-4 case, the pause is placed in front. (6c) and (6d) show 4-3 and 5-2 cases. (7), below, shows a summary of light syllable second lines. All cases except for the 3-4 case have a pause at the end of a line. The 3-4 case alone has a pause at the beginning.

- (7) Summary of light-syllable haiku:
 (a) End pause: 2-5, 4-3, 5-2
 (b) Front pause: 3-4

3.3 Heavy Syllables

Haiku second lines can include a heavy syllable. We divided the data according to which syllable is heavy. The data of lines with a heavy syllable are shown in (8) - (11). We describe the 2-5 case lines.

- (8) 2-5: end pause
 (a) 1st σ heavy:
 <.nyoo.><ya.ri.na.ga.ra.>  'while urinating'
 (b) 2nd σ heavy: n/a
 Logically impossible to have a 2 μ word with a 2nd heavy σ .
 (c) 3rd σ heavy:
 <.mu.ra.><ip.pai.no.>  'a village-full of'
 (d) 4th σ heavy:
 <.do.ko.><no.bot.te.mo.>  'wherever I climb'
 (e) 5th σ heavy:
 <.su.so.><hi.ki.zut.te.>  'drugging the sleeve'
 (f) 6th σ heavy:
 <.te.ri.><ko.ro.sa.ren.>  'burned and killed'

The first example (8a) has two words in a line. The first word has two moras, and the second word has five moras (2-5). In this example, the first syllable is heavy, and the pause comes at the end of the line.

(8b) shows that it is logically impossible to have a heavy second syllable when the word is a bimoraic word. This is because the haiku line is divided by a word boundary, and a heavy syllable, which must be within a word, cannot appear across a word boundary.

The next example (8c) has a heavy third syllable, and the pause comes at the end of the line.

The rest of the data are shown in (9) - (11) using the same method. A summary of the lines containing a heavy syllable is shown below the data set.

(9) 3-4: front pause

(a) 1st σ heavy:

☞<.en.no.><.u.e.na.ru.> 'above the balcony'

(b) 2nd σ heavy:

☞<.a.ran.><.ka.gi.ri.wa.> 'endless direction'

(c) 3rd σ heavy: n/a

Logically impossible to have a 3 μ word with a 3rd heavy σ .

(d) 4th σ heavy:

☞<.ko.na.mo.><.pap.pa.to.> 'weed also, (sweeping) swiftly'

(e) 5th σ heavy:

☞<.ho.to.ke.><.o.gan.de.> 'prays for buddha'

(f) 6th σ heavy:

☞<.to.ki.ya.><.tsu.ku.ran.> 'tell the time'

(10) 4-3: end pause

(a) 1st σ heavy:

<.shoo.ji.no.><.a.na.no.>☞ 'the hole in my shoji screen'

(b) 2nd σ heavy:

<.ji.zoo.no.><.so.de.ni.>☞ 'to the sleeve of Jizo'

(c) 3rd σ heavy:

<.fu.ku.roo.><.na.ku.ka.>☞ 'owl cries'

(d) 4th σ heavy: n/a

Logically impossible to have a 4 μ word with a 4th heavy σ .

(e) 5th σ heavy:

<.ho.to.ke.no.><.yoo.ni.>☞ 'like a buddha'

(f) 6th σ heavy:

<.fu.ru.ya.no.><.bo.tan.>☞ 'peony at the old house'

(11) 5-2: end pause

- (a) 1st σ heavy:
 <.oo.a.ku.bi.><shi.te.>[✱] 'yawns, and . . . '
- (b) 2nd σ heavy:
 <.sa.wat.te.mo.><de.ru.>[✱] 'even touching it, (tear-)drops'
- (c) 3rd σ heavy:
 <.ka.ku.rem.bo.><su.ru.>[✱] 'plays hide-and-seek'
- (g) 4th σ heavy:
 <.go.shu.tsu.gen.><a.re.>[✱] 'wish to came'
- (h) 5th σ heavy: n/a
 Logically impossible to have 5 μ word with a 5th heavy σ .
- (i) 6th σ heavy:
 <.ru.su.ni.shi.te.><min.>[✱] 'see after absence'

(12) Summary of heavy syllable

- (a) End pause: 2-5, 4-3, 5-2
 (b) Front pause: 3-4

In (12), a summary of the lines with a bimoraic syllable with respect to the pause position is shown.

(13) Summary of the data

		Front	End	
2-5	light		✓	< μ μ >< μ μ μ μ > [✱]
	heavy		✓	
3-4	light	✓		[✱] < μ μ μ >< μ μ μ μ >
	heavy	✓		
4-3	light		✓	< μ μ μ μ >< μ μ μ > [✱]
	heavy		✓	
5-2	light		✓	< μ μ μ μ μ >< μ μ > [✱]
	heavy		✓	

The chart in (13) shows the summary of both light and heavy syllables. The left-most column shows the number of moras in the words of a line, while the right-most column illustrates this schematically, along with the location of

pauses. A check mark shows whether a pause will be at the front or end of a line.

For example, in 2-5 lines, both light- and heavy-syllable lines have a pause at the end. In 3-4 lines, both light- and heavy-syllable lines have a pause at the front, and so on.

From this chart, it is apparent that both heavy and light syllable lines behave identically. Therefore, syllable weight has no effect on pause position. Also, only 3-4 lines have a front pause, while 2-5, 4-3 and 5-2 lines have a pause at the end. In our analysis we will account for this asymmetry in terms of OT.

4 Analysis

We provide our analysis in this section. The notions of non-headed feet and Alignment are introduced first, then the actual OT analysis follows. In addition, we make a prediction regarding other possible cases of word boundaries in haiku lines.

4.1 Non-headed feet and Alignment

First of all, we show that the notion of the foot can be applied to this data. Poser (1990) states that Japanese has non-headed bimoraic feet, and Kozasa (1997) applies this notion of the foot to haiku recitation. We assume that there are four feet present in a line of haiku.

(14) Foot Boundary represented by ()

$$\begin{array}{l} (\mu\mu)(\mu\mu)(\mu\mu)(\mu^{\text{light}}) \\ (^{\text{light}}\mu)(\mu\mu)(\mu\mu)(\mu\mu) \end{array}$$

As shown in (14), foot boundaries are represented by a pair of parentheses. A second line in haiku can be schematically represented as well-formed or ill-formed with respect to the location of a pause, as shown in (15).

(15) 3-4 lines: (a) well-formed $\checkmark (^{\text{light}}\mu)(\mu\mu)(\mu\mu)(\mu\mu)$
 (b) ill-formed $*(\mu\mu)(\mu\mu)(\mu\mu)(\mu\mu)$

The above example illustrates the following facts. In the well-formed line in (15a), every word boundary, which is an angled bracket, is aligned with the edge of a foot boundary, which is a parenthesis, except for the first one. In the ill-formed line in (15b) only the first word boundary is aligned with the foot boundary. Therefore, it seems that there is some kind of alignment requirement at work.

McCarthy and Prince (1993) introduced Generalized Alignment in the framework of OT. The Align constraint demands that one edge of a certain

category must be aligned with an edge of another category. The category may be either prosodic or morphological, as follows.

(16) Generalized Alignment (McCarthy and Prince 1993b)

e.g. ALIGN (Cat1, Edge1, Cat2, Edge2)_{=def}

\forall Cat1 \exists Cat2 such that Edge1 of Cat1 and Edge2 of Cat2 coincide.

McCarthy and Prince states that a Generalized Alignment requirement “demands that a designated edge of each prosodic or morphological constituent of type Cat1 coincide with a designated edge of some other prosodic or morphological constituent Cat2” (p. 2).

Following the above statement, we propose a constraint that demands that a word boundary be aligned with a foot boundary as shown below.

(17) Align -Wd Boundary, Ft Boundary: ALIGN(W, F)

Align every word boundary with a foot boundary

In this constraint, the direction of boundary edges is not specified, although traditional Alignment constraints specify the edgedness of an alignment requirement. This is because the ideal prosodic structure of a haiku line has ‘perfect’ alignment between word and foot boundaries, such as in (18) and (19), so that alignment of both left and right edges is equally important.

(18) The best prosodic structure: (< μ μ >), (< μ μ)(μ μ >)

(19) >) and (<

In the following section, optimal pause position is evaluated in terms of OT, with respect to non-headed feet and this new Alignment constraint.

4.2 OT evaluation

For the evaluation of the constraint given above, we look at each word boundary, both right and left edges, to see if it is aligned with a foot boundary. We have substituted the actual words of the haiku with μ , in order to simplify our explanation.

(20) Tableau: 3-4 case

		ALIGN(W, F)
(a)	(< $\mu\mu$)(μ >< μ)($\mu\mu$)(μ > μ)	***
μ (b)	(μ >< μ)($\mu\mu$)(< $\mu\mu$)($\mu\mu$ >)	*

(20) shows the evaluation of a 3-4 case. In (20a), the first word boundary, shown by an angle bracket, is aligned with the first foot boundary. However, the 2nd, 3rd and final word boundaries are not. Therefore, candidate (20a) has three violations of the Align constraint. In (20b), the first word boundary is not aligned with a foot boundary because it has a pause in front of it. However, the second, third, and final boundaries are adjacent to foot boundaries. Therefore, (20b) has only one violation, and it is selected as the optimal output.

The tableaux in (21) and (22) show that 4-3 and 2-5 cases can be accounted for by the same constraints.

(21) Tableau: 4-3 case

		ALIGN(W, F)
☞ (a)	(<μμ)(μμ)(<μμ)(μ> [☞])	*
(b)	([☞] <μ)(μμ)(μ><μ)(μμ)	***

(22) Tableau: 2-5 case

		ALIGN(W, F)
☞ (a)	(<μμ>)(<μμ)(μμ)(μ> [☞])	*
(b)	([☞] <μ)(μ><μ)(μμ)(μμ)	***

However, we have a problem in the 5-2 case, as shown in tableau (23).

(23) Tableau: 5-2 case: end-pause

		ALIGN(W, F)
(a)	(<μμ)(μμ)(μ><μ)(μ> [☞])	***
Ⓢ (b)	([☞] <μ)(μμ)(μμ)(μ>)<μμ>	*

In this case, (23a) violates the constraint three times, while (23b) violates it only once. Therefore, the wrong candidate (23b) wins. This is due to the fact that the 5-2 case is a mirror image of the 2-5 case, which has a pause at the end. As a result of this, the 5-2 case is incorrectly shown to have a pause at the front.

4.3 Cola in OT

In order to account for the asymmetry of the pause insertion above, we need a constraint that dominates ALIGN(W, F), as shown in (24).

(24) Tableau: 5-2 case: end-pause

		?	ALIGN(W, F)
☞ (a)	(<μμ)(μμ)(μ><μ)(μ> [☞])		***
(b)	([☞] <μ)(μμ)(μμ)(μ>)<μμ>	*!	*

If there is a constraint which dominates ALIGN(W, F), and it is violated by (24b) and not by (24a), then the correct candidate (24a) will be selected.

In order to formulate this new constraint, we make use of another prosodic unit, the colon, for the evaluation of haiku lines. A colon is a prosodic unit that consists of two feet (Halle and Clements 1983, Hammond 1987).

We represent a colon by a pair of square brackets. (25) schematically illustrates both well-formed and ill-formed second lines, showing word boundaries, feet, and cola.

(25) Colon = two feet: represented by []

- (a) well-formed ✓ [(<μμ)(μμ)][(μ><μ)(μ>[Ⓢ])]
 (b) ill-formed * [([Ⓢ]<μ)(μμ)][(μμ>)(<μμ>)]

In the well-formed line in (25a), the first colon boundary, which is the first square bracket, is aligned with the left edge of a word, which is the first angled bracket. The second colon is not. In contrast, in the ill-formed line in (25b), neither of the left edges of cola aligns with word boundaries.

Thus, we propose the following constraint.

(26) ALIGN - Colon boundary, Left, Word boundary, Left:

ALIGN(Colon, L, Word L)

The left edge of a colon is aligned with a left edge of a word.

The above constraint demands that the left edge of a colon is aligned with the left edge of a word. We specify the edge for this constraint, while we did not specify it for the previous one, ALIGN(W, F), because it seems that there is pressure to start a line with an actual uttered mora rather than an empty mora, a pause. The tableau below shows the new evaluation of the 5-2 case.

(27) Tableau: 5-2 case: end-pause

		ALIGN(C, W)	ALIGN(W, F)
☞ (a)	[(<μμ)(μμ)][(μ><μ)(μ> [Ⓢ])]	*	***
(b)	[([Ⓢ] <μ)(μμ)][(μμ>)(<μμ>)]	*!*	*****

The tableau above shows that (27a) is correctly chosen as the optimal output. The first left colon boundary, which is a left square bracket, is aligned with a left word boundary, which is a left angled bracket. This violates ALIGN(C, W) once, because the second left colon boundary is not aligned with a word boundary. In contrast, in (27b), neither of the left colon edges are aligned with word boundaries. Therefore, candidate (27a) wins out as most optimal.

The new constraint, however, must not effect the evaluation of the other three cases. The tableaux (28) through (30) show that this new constraint has no effect on the evaluation of the cases we have already considered.

(28) Tableau: 3-4 case

		ALIGN(C, W)	ALIGN(W, F)
(a)	$[(\langle \mu \mu \rangle)(\mu > \langle \mu \rangle)] [(\mu \mu)(\mu > \text{Ⓢ})]$	*	**!*
☞ (b)	$[(\text{Ⓢ} < \mu)(\mu \mu >)] [(\langle \mu \mu \rangle)(\mu \mu >)]$	*	*

(29) Tableau: 4-3 case

		ALIGN(C, W)	ALIGN(W, F)
☞ (a)	$[(\langle \mu \mu \rangle)(\mu \mu >)] [(\langle \mu \mu \rangle)(\mu > \text{Ⓢ})]$		*
(b)	$[(\text{Ⓢ} < \mu)(\mu \mu)] [(\mu > \langle \mu \rangle)(\mu \mu >)]$	*!*	***

(30) Tableau: 2-5 case

		ALIGN(C, W)	ALIGN(W, F)
☞ (a)	$[(\langle \mu \mu >)(\langle \mu \mu \rangle)] [(\mu \mu)(\mu > \text{Ⓢ})]$	*	*
(b)	$[(\text{Ⓢ} < \mu)(\mu > \langle \mu \rangle)] [(\mu \mu)(\mu \mu >)]$	*!*	***

The correct candidates are selected in all cases, when ALIGN(C, W) is ranked above ALIGN(W, F). We have accounted for the placement of pauses in haiku second lines using prosodic constraints regarding non-headed feet, non-directional alignment, and cola.

4.4 Predictions

There are other possible types of haiku second lines besides the ones we have analyzed as discussed in previous sections. We have not presented actual data for 1-6, 6-1 or 7 lines, shown in (31) below, because these are truly rare cases in Issa's haiku; but we expect that there are such data in other authors' poetry. However, from our analysis given above, the pause positions of 1-6, 6-1, and 6 mora lines are predicted.

(31) 6-1, 1-6, and 7

1-6	$\langle \mu \rangle \langle \mu \mu \mu \mu \mu \mu \rangle$
6-1	$\langle \mu \mu \mu \mu \mu \mu \rangle \langle \mu \rangle$
7	$\langle \mu \mu \mu \mu \mu \mu \mu \rangle$

The tableaux in (32) - (34) show the evaluation of these three cases.

(32) Tableau: 1-6 case

		ALIGN(C, W)	ALIGN(W, F)
(a)	$[(\langle \mu \mu > \langle \mu \rangle)(\mu \mu)] [(\mu \mu)(\mu > \text{Ⓢ})]$	*!*	***
☞ (b)	$[(\text{Ⓢ} < \mu >)(\langle \mu \mu \rangle)] [(\mu \mu)(\mu \mu >)]$	*	*

(33) Tableau: 6-1 case

		ALIGN(C, W)	ALIGN(W, F)
☞ (a)	$[(\langle \mu \mu \rangle)(\mu \mu)][(\mu \mu \rangle)(\langle \mu \rangle \text{☞})]$	*	*
(b)	$[(\text{☞} \langle \mu \rangle)(\mu \mu)][(\mu \mu)(\mu \rangle \langle \mu \rangle)]$	*!*	***

(34) Tableau: 7 case

		ALIGN(C, W)	ALIGN(W, F)
☞ (a)	$[(\langle \mu \mu \rangle)(\mu \mu)][(\mu \mu)(\mu \rangle \text{☞})]$	*	*
(b)	$[(\text{☞} \langle \mu \rangle)(\mu \mu)][(\mu \mu)(\mu \mu \rangle)]$	*!*	*

As shown in (32), the chosen pause position in the 1-6 case is the front position. However, the optimal lines for the 6-1 and 7 cases have a pause at the end, as shown in (33) and (34). The summary of these predictions is shown in (35).

(35) The pause positions predicted:

1-6	$\text{☞} \langle \mu \rangle \langle \mu \mu \mu \mu \mu \mu \rangle$
6-1	$\langle \mu \mu \mu \mu \mu \mu \rangle \langle \mu \rangle \text{☞}$
7	$\langle \mu \mu \mu \mu \mu \mu \mu \rangle \text{☞}$

5 Conclusion

In this paper, we have given an analysis of pause position in Japanese verse within the framework of OT. Utilizing the data from Issa's poetry, we have described the basic structure of haiku and shown that an empty mora, a pause, is inserted in the haiku for recitation. Our analysis has focused on the position of pauses in the second line of haiku due to the interesting fact that second-line pause position varies according to the structure of a line. We also limited our data to the 2-5, 3-4, 4-3, and 5-2 cases.³

We have analyzed native speakers' intuitions regarding pause positions in haiku in terms of OT. The prosodic elements which are required in our analysis are the notion of an empty mora, non-headed moraic binary feet, and cola. We have proposed two new Alignment constraints: ALIGN(Word, Foot) and ALIGN(Colon, L, Word L). The edgedness of ALIGN(W, F) is not required, since both right and left edges are treated equally in the evaluation. Our use of non-specified edgedness is new in the history of Alignment. On the other hand, ALIGN(Colon, L, Word L) requires the specification of edgedness, following the traditional interpretation of Generalized Alignment.

In addition, our analysis makes predictions regarding three types of second lines that are not found in Issa's poetry, as discussed in section 4.4. Finding the actual data which includes these cases, and the evaluation of such cases, is anticipated in our future research.

Notes

- * We would like to thank Diana Archangeli, Uldis Balodis, Sonya Bird, Allyson Carter, Debbie Cole, Colleen Fitzgerald, Mike Hammond, Sean Hendricks, Eloise Jelinek, Terry Langendoen, Laura Moll, Peter Norquest, Kazutoshi Ohno, Sachiko Ohno, Keiichiro Suzuki, Nicole Theobald, Tanya Zamuner, the WECOL 1998 committee members, and the audience of our presentation at the conference. We would also like to express our special appreciation to Jessica Maye. All mistakes are ours.
- ¹ We selected only one author for our analysis to regulate the data. Poetic verses sometimes vary their forms depending on the style of individual author. We agree upon the idea that it is important to look at one author before we make a whole generalization of Japanese verses.
- ² We tentatively call both a word and a word with particle(s) a “word” in this paper.
- ³ Although this analysis shows that a 5-2 line will have an end pause, when 5 mora words result from 3-2 moraic word compounds, the pause may instead occur in the front-position, due to the integrity of the 2 mora word.

References

- Bekku, Sadanori. 1977. *Nihongo no Rizumu*. Tokyo: Kodansha.
- Carter, Allyson. 1996. *An Acoustic Analysis of Weak Syllable Omissions: Evidence for Adult Prosodic Representations in Young Children's Speech*, ms. University of Arizona, 1996.
- Carter, Allyson. 1998. “You Don't Say! The Phonetic Manifestation of Unpronounced Syllables”, in *Proceedings of Texas Linguistic Forum: Conference on Exploring the Boundaries Between Phonetics and Phonology, 1998*.
- Fitzgerald, Colleen. 1995. “ ‘Poetic Meter >> Morphology’ in Tohono O’odham,” Paper presented at the 1995 Annual Meeting of the Linguistic Society of America, 1995.
- Fitzgerald, Colleen. 1997. *O’odham Rhythms*, Ph.D. dissertation, University of Arizona.
- Golston, Chris. (to appear) “Constraint-Based Metrics,” *Natural Language and Linguistic Theory*.
- Halle, Morris, and George N. Clements. 1983. *Problem Book in Phonology*, MIT Press, Cambridge, MA.
- Hanson, Kristin and Paul Kiparsky. 1996. “A parametric Theory of Poetic Meter,” *Language*, 72. 2: 287 - 335.
- Hammond, Michael. 1987. “Hungarian Cola”, *Phonology Yearbook*, 4: 267-69.
- Hayes, Bruce. 1995. *Metrical Stress Theory: Principles and case studies*. Chicago: University of Chicago Press.
- Kawakami, Shin. 1973. *Nihongo onsuritsu no saikentou* (Reexamination of the rhythm of Japanese verse) *Onishi hakase kiju kinen Onseigaku sekai ronbunshuu* (*Worldwide anthology of papers in phonetics in honor of Dr. Onishi's seventy-seven birthday*).
- Kobayashi, Issa. 1997. *The spring of my life and selected Haiku*. Translated by Sam Hamill. Boston: Shambhala Publications, Inc.
- Kozasa, Tomoko. 1997. “Rhythm or Meter: Moraic Tetrameter in Japanese Poetry”, ms. California State University, Fresno.
- McCarthy, John, and Alan Prince. 1993a. *Prosodic Morphology I*, ms. University of Massachusetts at Amherst and Rutgers University.

- McCarthy, John, and Alan Prince. 1993b. General Alignment, ms. University of Massachusetts at Amherst and Rutgers University.
- Poser, William J. 1990. "Evidence for Foot Structure in Japanese", *Language*. 66. 1: 79-80.
- Prince, Allan and Paul Smolensky. 1993. Optimality Theory, ms. Rutgers University and University of Colorado Boulder.
- Raboku, Ohashi ed.. 1929. *Issa Haiku Zenshuu*. Tokyo: Shuujun-sha.

Kumi Kogure
Linguistics Department
University of Arizona
Douglass Building, Room 200E
Tucson, AZ 85721
kogurek@u.arizona.edu

Mizuki Miyashita
Linguistics Department
University of Arizona
Douglass Building, Room 200E
Tucson, AZ 85721
mizuki@u.arizona.edu

A Constraint-Based Account of Ordering Paradox between Aspiration and Cluster Simplification in Korean*

Shinsook Lee and Mi-Hui Cho

Hoseo University and Pukyong National University

1. Introduction

In Korean heteromorphemic sequences of /l/ plus /p, t, k/ and /p, t, k/ plus /l/ both emerge as aspirated [p^h, t^h, k^h]. Korean also has Cluster Simplification by which underlying CVCC forms surface as CVC when the cluster is in word-final position or when it is followed by a consonant-initial syllable. The interaction between Aspiration Merger and Cluster Simplification, however, has posed a serious problem to a nonderivational approach. For example, in *k'inh-ta* [k'in.t^ha] 'cut-Declarative' the second consonant /l/ of the cluster merges with the following consonant when the aspiration is progressive. This suggests that Cluster Simplification occurs after Aspiration Merger; otherwise, we would have a wrong output *[k'in.da]. But unlike progressive Aspiration Merger, regressive Merger applies after Cluster Simplification, as the example

kaps+hako [ka.p^ha.go] ‘price and’ demonstrates: the second consonant /s/ should be deleted before Aspiration Merger. The interaction between Aspiration Merger and Cluster Simplification also shows difference between Seoul and Kyongsang dialects. For instance, *hilk+hako* [hi.k^ha.go] (Seoul)/[hi.la.go] (Kyongsang) ‘with dirt’ illustrates that the stop consonant /k/ is merged with /h/ after Cluster Simplification in Seoul dialect while the lateral segment /l/ is realized after Cluster Simplification in Kyongsang.

Based on these facts, Shim (1995) claims that Optimality Theory (henceforth OT, Prince and Smolensky 1993, McCarthy and Prince 1993a, b) cannot account for the ordering paradox between Aspiration Merger and Cluster Simplification because there are no derivational steps within OT. But Korean clearly shows that there should be derivational steps: progressive Aspiration Merger precedes Cluster Simplification, which in turn precedes regressive Aspiration Merger.

In this paper, however, we argue that a constraint-based model provides a better account of this phenomenon than a rule-based one does. Specifically, we will show that both progressive and regressive Aspiration Merger can be uniformly analyzed by markedness and faithfulness constraints, without extrinsic rule ordering between Aspiration Merger and Cluster Simplification. We will also demonstrate that faithfulness constraints, in particular Max(peripheral) and Max(sonorant) are responsible for the difference between Seoul and Kyongsang dialects.

The organization of this paper is as follows. Section 2 presents data concerning Aspiration Merger and Cluster Simplification. Section 3 examines previous analyses and problems. Section 4 provides a constraint-based analysis of the interaction between Aspiration Merger and Cluster Simplification. Section 5 summarizes conclusions reached.

2. Data

In Korean sequences of heteromorphemic /h/ plus /p, t, k/ are merged into a single aspirated stop, as shown in (1). The reverse sequences of /p, t, k/ plus /h/ are also merged into a single aspirated stop, as in (2).

(1) Progressive Aspiration Merger¹

a. coh+ko	[co.k ^h o]	'like-Connective'
nah+ta	[na.t ^h a]	'give birth-Declarative'
suh+pəm	[su.p ^h əm]	'male-tiger'
suh+k'wəŋ]	[su.k ^h wəŋ]	'male pheasant'
b. k'inh+ta	[k' in.t ^h a]	'cut-Declarative'
hinh+ko	[hin.k ^h o]	'common-Connective'
silh+ta	[sil.t ^h a]	'dislike-Declarative'
olh+ko	[ol.k ^h o]	'right-Connective'

(2) Regressive Aspiration Merger

ip+hak	[i.p ^h ak]	'admission'
sok+hi	[so.k ^h i]	'fast-Adverbial'
kaps+hako	[ka.p ^h a.go]	'price and'
pak'+hako	[pa.k ^h a.go]	'exterior and'

As mentioned in Section 1, progressive Aspiration Merger must precede Cluster Simplification, which will be discussed below (cf. *k'inh+ta* [k'in.t^ha] *[k'in.da]). On the other hand, regressive Aspiration Merger must follow Cluster Simplification (cf. *kaps+hako* [ka.p^ha.go]).

Korean also has Cluster Simplification which forces underlying CVCC forms to be realized as CVC when the cluster occurs word finally or when a consonant-initial syllable follows, as illustrated in (3). ("~" indicates the

unreleasing of a segment in the coda.)

(3) Cluster Simplification

a. Seoul and Kyongsang Dialects

UR	Suffix	PR	Gloss
kaps		[kap̚]	'price'
kaps+	to	[kap̚.t'o]	'price-and'
kaps+	i	[kap̚.fi]	'price-Nominative'

b. Seoul Dialect

UR	Suffix	PR	Gloss
palp		[pap̚]	'to step on'
palp+	ko	[pap̚.k'o]	'to step on-Connective'
palp+	a	[pal.ba]	'to step on-Stative'

c. Kyongsang Dialect

UR	Suffix	PR	Gloss
palp		[pal]	'to step on'
palp+	ko	[pal.k'o]	'to step on-Connective'
palp+	a	[pal.ba]	'to step on-Stative'

In (3a) the underlying coda cluster /-ps/ is simplified as [p] in both Seoul and Kyongsang dialects. However, when the underlying coda cluster consists of a sonorant consonant and a stop such as /-lp/, it is the stop that surfaces in Seoul dialect (3b), whereas it is the sonorant consonant which survives in Kyongsang dialect (3c).

Cluster Simplification also interacts with Aspiration Merger in a different way depending on dialects, as shown in (4).

(4) Cluster Simplification and Aspiration Merger

a. Seoul and Kyongsang Dialects

kaps+hako [ka.p^ha.go] ‘price and’saks+hako [sa.k^ha.go] ‘share and’

b. Seoul Dialect

hilk+hako [hi.k^ha.go] ‘with dirt’talk+hako [ta.k^ha.go] ‘with a chicken’

c. Kyongsang Dialect

hilk+hako [hi.la.go]² ‘with dirt’

talk+hako [ta.la.go] ‘with a chicken’

In (4a) /h/ is merged with a surviving stop resulted from Cluster Simplification both in Seoul dialect and Kyongsang dialect. Similarly, /h/ is coalesced with the velar stop /k/ in Seoul dialect as in (4b). However, in Kyongsang dialect Aspiration Merger does not occur since the liquid /l/ survives from Cluster Simplification as in (4c). Thus, /h/ deletes because there is no stop that can serve as a docking site for Aspiration Merger. In the next section we will examine previous analyses concerning these phenomena and shortcomings of the analyses.

3. Previous Analyses and Problems

Based on the ordering problem, the interaction between Aspiration Merger and Cluster Simplification has been analyzed within a derivational model which assumes extrinsic rule ordering. For instance, Iverson and Kim-Renaud (1994) analyze Aspiration Merger, either progressive or regressive, by spreading the specified features (or nodes) from coda to the unspecified onset. Thus, in case of

/coh+ko/ 'like-Connective', it first becomes /coh+k^ho/ by the spreading procedure, and then [co.k^ho] by simplification. Likewise, /ip+hak/ 'admission' becomes /ip+p^hak/ by spreading and then it is simplified as [i.p^hak]. Their analysis, however, has serious problems. First, their analysis produces an intermediate stage, such as /coh+k^ho/ and /ip+p^hak/, which is never surface-true. Second, we would have a wrong output *[hɨl.k^ha.go] for /hɨlk+hako/ 'with dirt' in Kyongsang dialect as a result of spreading and Cluster Simplification. That is, /hɨlk+hako/ becomes /hɨlk+k^hako/ by spreading procedure and it further becomes /hɨlk^ˀ+k^hako/ by Coda Neutralization which allows only nonreleased lax stops in syllable-final position. At this point, /hɨlk^ˀ+k^hako/ surfaces as *[hɨl.k^ha.go] by Cluster Simplification in Kyongsang since in a sequence of a sonorant plus stop only a sonorant consonant /l/ is a legitimate segment in coda position in this dialect.

Similarly, Shim (1995) contends that OT, which assumes a parallelistic mode of constraint interaction, cannot account for the ordering problems between Aspiration Merger and Cluster Simplification. This is because progressive Aspiration Merger precedes Cluster Simplification, which in turn precedes regressive Aspiration Merger. Thus, he claims that the rule-based model which assumes derivational steps provides a better account of Korean phonology than OT does.³ However, Shim's analysis also has some drawbacks. Most importantly, his account cannot provide a unified analysis of Aspiration Merger since he treats progressive and regressive Aspiration Merger separately, although it can be viewed as a single phonological phenomenon. In addition, his analysis posits extrinsic rule ordering between Aspiration Merger and Cluster Simplification which imposes a burden on the Korean grammar. Thus, in the following section, we will provide an alternative to the derivational approach.

4. A Constraint-based Analysis

4.1 The correspondence theory framework

Correspondence Theory (McCarthy and Prince 1995) is a recent development of Optimality Theory. Like OT, Correspondence Theory is a model of constraints and constraint interaction which claims that an optimal form is selected through the evaluation of an array of candidate outputs in a parallel mode. Unlike OT, however, Correspondence Theory emphasizes an identity relation between input and output, as the definition given in (5) illustrates.

(5) Correspondence (McCarthy and Prince 1995):

Given two strings S_1 and S_2 , **correspondence** is a relation R from the elements of S_1 to those of S_2 . Elements $\alpha \in S_1$ and $\beta \in S_2$ are referred to as **correspondents** of one another when $\alpha R \beta$.

In the context of Correspondence Theory, faithfulness constraints in OT are redefined as constraints on correspondence. Namely, the Parse and Fill constraints in OT are replaced by Max and Dep, respectively, along with newly added Ident constraints.

(6) a. The Max Constraint Family

Every element of the input has a correspondent in the output. (No phonological deletion)

b. The Dep Constraint Family

Every element of the output has a correspondent in the input. (No phonological insertion)

c. The Ident (F) Constraint Family

Correspondent elements in the input and output have identical values for some feature [F]. (No feature change)

4. 2 A unified analysis of progressive and regressive aspiration merger

In this subsection we show that a correspondence theoretic analysis provides a unified account of Aspiration Merger without derivational steps. Specifically, we demonstrate that Aspiration Merger can be accounted for by the constraint interaction between markedness and faithfulness constraints.

First, let us consider constraints relevant to our analysis. As seen in Section 2 (cf. (3)), Korean syllable structure does not allow onset or coda clusters. Thus, underlyingly tautomorphemic sequence of CVCC is simplified when it occurs word-finally or when a consonant-initial syllable follows. This fact can be captured by the following *Complex constraint, which is undominated in Korean.

(7) *Complex (Prince and Smolensky 1993)

No onset or coda clusters are allowed

Syllable-final consonants in Korean are also subject to Coda Condition by which obstruents in coda position emerge as neither aspirated nor tensed but as unreleased lax stops. As a consequence, /p, p^ʰ/ realize as the unreleased lax [p[̚]], /t, t^ʰ, c, c^ʰ, s, s^ʰ, h/ as [t[̚]], and /k, k^ʰ/ as [k[̚]]. Iverson and Kim-Renaud (1994) interpret the coda neutralization effect in terms of the phonetic implementation principle whereby oral contact in syllable-final consonants is maintained throughout the segment's articulation in Korean. We assume that the coda neutralization effect is captured by the following constraint of Coda Condition, which is also undominated in Korean.

(8) Coda Condition

Only nonreleased lax stops are possible in the coda.

As seen by the data in Section 2, /h/ is not realized in certain environments, and thus there should be a markedness constraint *h which forbids the occurrence of /h/, given below.

(9) *h: no /h/

The motivation for this constraint comes from the phonetic fact that the glottal fricative /h/ does not require the vocal tract configuration. Accordingly, the shape of vocal tract during /h/ is often determined by the adjacent segments.

The nonrealization of /h/ by the markedness constraint *h is penalized by the faithfulness constraint Max-IO(spread glottis) which prohibits the deletion of the feature [spread glottis], as shown in (10).

(10) Max-IO(spread glottis): The feature [spread glottis] in the input has a correspondent in the output.

Since /h/ tends not to be realized, the markedness constraint *h dominates the faithfulness constraint Max-IO(spread glottis).

There is another faithfulness constraint on the number of segments between input and output, as provided in (11).

(11) Max-IO(segment): A segment in the input has a correspondent in the output.

The constraint Max-IO(segment) penalizes deletion of segments from the input.

Because the constraint *h is ranked higher than the constraint Max-IO(spread

glottis). /h/ may be deleted or be coalesced with an adjacent obstruent becoming an aspirated stop, depending on the environment. When /h/ deletes, the constraint Max-IO(s.g.) is violated in order not to violate the constraint *h. However, there is a way not to violate both constraints *h and Max-IO(s.g.) when there is a neighboring obstruent. Namely, the constraint *h may not be violated by merging /h/ with a neighboring obstruent. At the same time, Max-IO(s.g.) is not violated since /h/ survives in the form of aspiration, even though this leads to a violation of the constraint *MC (Multiple Correspondence) in (12).

(12) *MC (Lamontagne and Rice 1995):

Elements of input and output must stand in a one-to-one correspondence relationship with each other.

The constraint *MC rules out candidates whose elements of the input do not stand in a one-to-one correspondence relation with elements of the output.

Based on the discussion above, we tentatively propose the following ranking: *Complex, Coda Cond >> *h >> Max-IO(s.g.) >> Max-IO(segment), *MC.⁴ With this constraint ranking we provide a principled account of Aspiration Merger.

Let us consider the following tableau in (13) which shows progressive Aspiration Merger.

(13) Progressive Aspiration Merger

	k' inh+ta	*CC	Coda Cond	*h	Max-IO (s.g.)	Max-IO (Segment)	*MC
a.	k' inh.ta	*!	*	*			
b.	k' in. ^h a					*	*
c.	k' ih.ta		*!	*		*	
d.	k' in.ta				*!	*	

In (13) candidate (a) with a coda cluster is ruled out because it violates the undominated constraint *CC. Candidate (c) with [h] in coda position is also eliminated from consideration. Even though candidate (d) satisfies high-ranked constraints of *CC, Coda Condition, and *h, it is out due to Max-IO(s.g.). Thus, candidate (b) is optimal, only violating low-ranked constraints Max-IO(segment) and *MC.

Regressive Aspiration Merger receives the same treatment as progressive Aspiration Merger as the following tableau illustrates.

(14) Regressive Aspiration Merger⁵

	Kaps+hako	*CC	Coda Cond	*h	Max-IO (s.g.)	Max-IO (segment)	*MC
a.	kaps.ha.go	*!	*	*			
b.	kap.ha.go		*!	*		*	
c.	kas.ha.go		*!	*		*	
d.	kap ka.p ^h a.go					**	*
e.	kap ^h .sa.go				*!	*	
f.	kap ^h .ha.go			*!		*	

In (14) candidate (a) is out of the competition because it fatally violates undominated constraints. Similarly, candidates (b) and (c) violate the undominated constraint of Coda Condition. Candidate (f) with /h/ realized in the onset results in the violation of the markedness constraint *h, which is fatal. Candidate (e) is not optimal due to its violations of Max-IO(s.g.) and Max-IO(segment). In contrast, candidate (d) emerges as the winner, even though it violates Max-IO(segment) twice. Therefore, Max-IO(s.g.) outranks Max-IO(segment), as suggested above.

4.3 The interaction between aspiration merger and cluster simplification in Seoul and Kyongsang dialects

Now let us turn to Cluster Simplification in Korean, which shows a dialectal difference between Seoul and Kyongsang. When a consonant cluster consists of obstruents, only peripheral consonants such as labials and velars survive in both dialects (e.g., /kaps/ [kap̚] ‘price’). However, if a consonant cluster consists of a sequence of a sonorant plus obstruent, dialectal variation occurs. In particular, peripherals surface in Seoul dialect whereas sonorant consonants surface in Kyongsang dialect. Thus, /hilk/ ‘dirt’ becomes [hik̚] in Seoul dialect and [hil] in Kyongsang dialect. Based on this fact, we propose the following Max constraint family (Iverson and Lee 1995).

(15) Max-IO(peripheral)

The feature [peripheral] in the input has a correspondent in the output.

(16) Max-IO(sonorant)

The feature [sonorant] in the input has a correspondent in the output.

The constraint Max-IO(peripheral) penalizes the deletion of the feature [peripheral], while Max-IO(sonorant) gives a penalty against the deletion of the feature [sonorant]. In Seoul dialect Max-IO(peripheral) dominates Max-IO(sonorant) ensuring that peripheral consonants survive in the sequence of a sonorant plus obstruent. In contrast, in Kyongsang dialect Max-IO(sonorant) ranks over Max-IO(peripheral), resulting in the occurrence of the sonorant in the same sequence.

With these two constraints, the interaction between Aspiration Merger and Cluster Simplification in Seoul and Kyongsang can be accounted for in a principled way, as the following tableaux illustrate.

(17) Seoul Dialect⁶

hilk+hako	*CC	Coda Cond	*h	Max-IO (peri)	Max-IO (son)	Max-IO (s.g.)	Max-IO (segment)	*MC
a. hilk.ha.go	*!	*	*					
b. hil.ha.go			*!	*			*	
c. hik.hago		*!	*		*		*	
d. hik hi.k ^h a.go					*		**	*
e. hik ^h .hago			*!		*		*	
f. hi.la.go				*!		*	**	

In (17) candidate (a) fatally violates *CC, in addition to Coda Condition and *h. Candidates (b) and (c) also fatally violate *h. Candidate (c) is ruled out because of its violation of the undominated constraint Coda Condition. Candidate (f) with sonorant /l/ instead of velar /k/ leads to a fatal violation of Max-IO(peripheral). Consequently, candidate (d) emerges as the optimal form.

In Kyongsang dialect, the realization of sonorant /l/ over /k/ can be accounted for by putting Max-IO(sonorant) over Max-IO(peripheral), as shown in (18).

(18) Kyongsang Dialect⁷

hilk+hako	*CC	Coda Cond	*h	Max-IO (son)	Max-IO (peri)	Max-IO (s.g.)	Max-IO (segment)	*MC
a. hilk.ha.go	*!	*	*					
b. hil.ha.go			*!		*		*	
c. hik.hago		*!	*	*			*	
d. hi.k ^h a.go				*!			**	*
e. hik ^h .hago			*!	*			*	
f. hik hi.la.go					*	*	**	

In (18) candidate (a) with a coda cluster violates undominated constraints. Candidates (b) and (e) with a fatal violation of *h are out of the competition. Similarly, candidate (c) is also out due to a violation of Coda Condition, in

addition to *h and other constraints. Candidate (d) with a surviving velar is not the optimal form since it violates high-ranked Max-IO(sonorant). Therefore, candidate (f) with the sonorant /l/ wins out.

In sum, we propose the following constraint hierarchy for Aspiration Merger and Cluster Simplification in Korean.

(19) The Constraint Hierarchy

a. Seoul Dialect: *CC, Coda Cond >> *h, Max-IO(peri) >> Max-IO(son) >> Max-IO(s.g.) >> Max-IO(segment), *MC

b. Kyongsang Dialect: *CC, Coda Cond >> *h, Max-IO(son) >> Max-IO(peri) >> Max-IO(s.g.) >> Max-IO(segment), *MC

5. Conclusion

A constraint-based analysis has been shown to handle successfully phonological phenomenon involving Aspiration Merger and Cluster Simplification in Korean. Specifically, we have demonstrated that both progressive and regressive Aspiration Merger can be uniformly analyzed by the constraint ranking given in (19) in which the markedness constraint *h dominates the faithfulness constraint Max-IO(spread glottis), without extrinsic rule ordering as in a rule-based model. Consequently, the ordering problem which seems to require derivational steps is easily resolved within Correspondence Theory. Further, the dialectal difference between Seoul and Kyongsang resulted from the interaction between Aspiration Merger and Cluster Simplification has been accounted for in a principled way by the alternating ranking between Max(peripheral) and Max(sonorant).

End Notes

* We are grateful to Stuart Davis and Gregory Iverson for their valuable comments and suggestions on the paper.

¹ In Korean /s/ becomes [ʃ] before the high front vowel /i/. Also, obstruents and /l/ become voiced and [r], respectively, in intervocalic position. However, we will not deal with palatalization, voicing and *r* weakening which are not relevant to our discussion.

² In extra careful speech the pronunciation of [hil.ha.go] and [tal.ha.go] is also possible.

³ Shim (1995) also deals with the interaction between Cluster Simplification and Tensification, which seems to require derivational steps. Like other scholars, however, we assume that this phenomenon can be accounted for by adopting output-output constraints or sympathy-related concepts (Benua 1997, Davis, 1997, McCarthy 1998, Rachel 1998, Tak 1997).

⁴ We will show evidence for the ranking between Max-IO(s.g.) and Max-IO(segment) shortly.

⁵ In principle, we may think of another candidate [ka p̣.s^ha.go]. However, as Kang (1992) suggests, Cluster Simplification and Coda Neutralization in Korean are prosodic-word bounded phenomena. Specifically in Korean, a stem and a prefix form a separate prosodic word whereas a suffix cannot form a separate prosodic word of its own. Thus, in case of *kaps+hago*, *kaps* and *hago* form a separate prosodic word, and within this domain *Complex and Coda Condition apply. As a result, the candidate [ka p̣.s^ha.go] where both consonants are realized loses because it fatally violates the constraint of *Complex. In the same vein, the candidate (e) of the tableau (14) in which both consonants of the cluster survive can be regarded as fatally violating *Complex. However, we do not pursue this in detail because it is beyond the scope of this paper.

⁶ In spite of the markedness constraint *h, /h/ surfaces in word-initial position (e.g., /hilk/). This is because of the role of an undominated constraint, Align-Left(stem, syllable), which has the effect of prohibiting the deletion of word-initial /h/. Additionally, we may think of another candidate [hil.k^ha.go]. As mentioned in footnote 5, however, this candidate cannot be the optimal form since *hilk* and *hago* each forms its own prosodic word and within this domain both consonants *l* and *k* are realized, thus violating *Complex.

⁷ As mentioned in footnote 2, [hil.ha.go] is possible in extra careful speech. We suggest that this form can be chosen as the optimal output by putting the constraint *h below Max-IO(spread glottis).

References

Benua, Laura. 1997. *Transderivational Identity: Phonological Relations between Words*.

Doctoral dissertation, University of Massachusetts, Amherst.

Davis, Stuart. 1997. The flowering of optimality theory: Ponapean nasal substitution

- and the problem of intermediate forms. Ms, Indiana University.
- Iverson, K.G. and Y-K, Kim-Renaud. 1994. "Phonological incorporation of the Korean approximant", Paper presented at the ninth International Conference on Korean Linguistics, London.
- Iverson, K.G. and Shinsook, Lee. 1995. "Variation and optimality in Korean cluster reduction", *ESCOL*, 11. 174-185.
- Kang, O.M. 1992. "Word-internal prosodic words in Korean", *NELS*, 22.
- Lamontagne, Greg and Keren, Rice. 1995. "A correspondence account of coalescence", *UMOP*, 18. 211-223.
- McCarthy, John. 1998. Sympathy and phonological opacity. Ms, University of Massachusetts, Amherst.
- McCarthy, John and Alan, Prince. 1993a. Prosodic morphology I: Constraint interaction and satisfaction. Ms, University of Massachusetts, Amherst and Rutgers University.
- McCarthy, John and Alan, Prince. 1993b. "Generalized alignment", *Yearbook of Morphology*. 79-153. Dordrecht, Boston, London: Kluwer Academic Publisher.
- McCarthy, John and Alan, Prince 1995. "Faithfulness and reduplicative identity", *UMOP*, 18. 249-384.
- Shim, Min-su. "A syllabification and consonant cluster simplification", *FLSM*, 6. 51-61.
- Tak, J. 1997. "Sympathy in accounting for opacity with reference to Korean", Paper presented at the fall meeting of the Linguistic Society of Korea.
- Walker, Rachel. 1998. *Nasalization, Neutral Segments, and Opacity Effects*. Doctoral dissertation, University of California, Santa Cruz.

Embedded Topicalization in English and Japanese

Hideki Maki, Lizanne Kaiser, and Masao Ochi
Salem-Teikyo U., Yale U., and U. of Connecticut

1. Introduction*

There have been two approaches to embedded topicalization in English. Baltin 1982 and Lasnik and Saito 1992, among others, argue that it involves IP adjunction, while Authier 1992 and Watanabe 1993, among others, argue that it involves CP recursion. The purpose of this paper is to defend the IP adjunction analysis and to derive restrictions on embedded topicalization from an independently motivated condition. In Section 2 we will argue that embedded topicalization requires two kinds of licensing: 1) a topic is licensed in the projection of INFL; and 2) INFL is licensed by adjoining to COMP in LF. In Section 3 we also show that English and Japanese have the same restrictions on embedded topicalization, and based on the Japanese data we provide evidence for movement of INFL to COMP in the construction. We also discuss an implication of the proposed analysis. Section 4 concludes this paper.

2. English

Let us first consider the issue of the landing site of embedded topicalization. The examples in (1) from Lasnik and Saito 1992 constitute evidence against the CP recursion analysis:

- (1) a. John thinks that himself_i Mary likes t_i.
b. *John thinks that himself_j (t_i) likes Mary.

(1a), which involves topicalization of the object in the embedded clause, is grammatical, while (1b), which involves the subject under either the canonical in-situ or topicalization readings, is ungrammatical. In (1a), the anaphoric embedded object *himself* has moved to a position (either adjoined to IP or moved to CP SPEC) where it can be properly bound by the antecedent *John* in the matrix clause. In (1b), however, if the anaphoric subject were to remain in

situ in the IP SPEC of the embedded clause, it would be ruled out due to a Binding Condition A violation. Alternatively, if this subject were topicalized and thus presumably adjoined to IP or moved to CP SPEC, (1b) would be expected to be grammatical, just like (1a).

Under the CP recursion analysis, the embedded subject would move to the SPEC of a phonetically null COMP contained within the clause headed by *that*, and there would be no obvious way to rule out the derivation of (1b). Therefore, the CP recursion analysis cannot be maintained as it is.

On the other hand, under the IP adjunction hypothesis, there is a way to explain the ungrammaticality of (1b). Let us consider Lasnik and Saito's 1992 analysis. They account for (1b) by proposing that only X^0 categories can be proper governors. In (1b) the trace of the embedded subject is not properly governed by any X^0 category before LF, and thus this trace runs afoul of the Empty Category Principle (ECP). However, under the Minimalist Program put forth by Chomsky 1993, 1995, the ECP is not assumed, and thus a new account of (1b) needs to be sought.

Under the Minimalist Program, movement operations must be triggered by feature checking. Given this, the question arises as to how feature checking might be done in the embedded topicalization construction under the IP adjunction analysis. Because the topic adjoins to IP, feature checking should be done between it and the head INFL.¹ In the case of (1a), the topic adjoins to the embedded IP, and feature checking is done between the topic and INFL.

In (1b), on the other hand, there is no need for the topic to adjoin to the embedded IP. If this subject has a topic feature to be checked, then this feature checking could be done under a SPEC-head relation between the topic in its surface position (i.e., IP SPEC) and INFL. Therefore, under this system the ungrammaticality of (1b) is explained simply as a violation of Binding Condition A since *himself* in IP SPEC cannot be properly bound by *John* in the matrix clause. Note that since *himself* in (1b) is already licensed as a topic in its in-situ position via SPEC-head agreement with INFL, it has no motivation to adjoin to IP, and therefore it is prevented from moving merely to satisfy some later binding relation (cf. the Last Resort Principle due originally to Chomsky 1986). Thus, our hypothesis that topicalization involves SPEC-head agreement between a topic and INFL directly accounts for the contrast in (1).²

Let us now turn to restrictions on embedded topicalization in English. As discussed in the previous literature and illustrated in (2), embedded topicalization is only possible in certain environments. It should also be noted that there is some variation in the judgments of these data, as will be discussed below:

- (2) a. John believes ok/*(that) this book, Mary read.
 b. ok/? John wonders if/whether this book, Mary read.
 c. ok/* John regrets that this book, Mary read.
 d. ok/* John believes the rumor that this book, Mary read.
 e. * Before this book, Mary read, John had already read it.
 f. * That this book, Mary read is true.

As in (2a), embedded topicalization is permissible within complement clauses of bridge verbs, although there is speaker variation as to whether or not the complementizer *that* can felicitously be omitted. Both our American and British consultants generally accept the omission of *that* in this context, but this contrasts with the judgments given in Watanabe 1993 and other sources cited therein. (2b) shows that embedded topicalization is also generally acceptable in interrogative clauses. These initial facts suggest that the type of COMP (e.g., whether it be overt or null in some dialects) plays an important role in the licensing of embedded topicalization. Next, (2c) and (2d) again reflect some dialectal variation. According to Authier 1992, Watanabe 1993, and in accordance with our own American judgments, embedded topicalization is impossible both in complement clauses of factive verbs and in noun-complement clauses. Authier 1992 assumes that factive complements are not L-marked, and Stowell 1981 and Grimshaw 1990, among others, argue that noun-complement clauses are adjuncts. According to our British consultants, on the other hand, (2c) and (2d) are acceptable. An explanation for this variation will be given further below. Finally, (2e) and (2f) show that embedded topicalization is consistently impossible in an adjunct clause and in a sentential subject.³ The above examples suggest that either a topic or INFL has a close relation with an L-marked COMP. Thus, it is plausible to assume that a relevant feature in either the topic or INFL is licensed by such a COMP.

There are two possible ways to license a feature. One is by binding, and the other by movement. (See Baker 1970 and Pesetsky 1987, among others, for licensing of *wh*-phrases by binding.) Suppose that this licensing by the L-marked COMP in the embedded topicalization construction involves binding. Then, all the examples in (2) would uniformly be predicted to be grammatical, since in each example the COMP would bind the relevant feature. Therefore, licensing by binding is not a plausible account for these data.

Suppose then that the licensing by COMP in embedded topicalization constructions involves movement. The question is what moves when to COMP. As for the timing of movement, since the topic does not move across COMP and INFL does not move to COMP in overt syntax, let us assume that the movement takes place in LF. Then, the question is what moves to COMP in LF. The candidates are shown in (3):

- (3) a. a feature in the topic
 b. a feature in INFL
 c. INFL

Note that the ungrammaticality of (1b) precludes the possibility of the entire topic moving to COMP in LF, otherwise we would expect no contrast in the acceptability of (1a) versus (1b). For reasons to be clarified in Section 3, let us assume here that INFL moves to COMP in LF. Following Takahashi 1994, we will show below that this LF movement hypothesis correctly predicts the grammaticality judgments of the examples in (2).

Takahashi 1994 provides evidence that adjunction to non-L-marked phrases, namely, adjuncts and derived subjects, is prohibited. In showing the evidence, he assumes that specifiers are created by adjunction rather than substitution, following Fukui and Saito 1992, Kayne 1994, Chomsky 1994, among others.

First, based on a Case conversion phenomenon in Japanese, he shows that adjunction to adjuncts is prohibited. Consider the examples in (4):

- (4) a. [NP [IP *kyonen* *Mary-ga/no* *katta*] *hon*]-o *yonda*.
 last year -nom/gen bought book-acc read
 'I read the book Mary bought last year.'
- b. *kyonen* *Mary-ga/*no* *hon*-o *katta*.
 last year -nom/gen book-acc bought
 'Mary bought a book last year.'

The above examples show that a subject may be marked with genitive Case only in a clause that constitutes a complex NP. To account for this, Miyagawa 1993 and Ura 1993 argue that while nominative Case is licensed inside the clause, genitive Case is checked in NP SPEC. Assuming this, Takahashi gives the examples in (5) from Fujita 1988 to show the argument/adjunct asymmetry of Case conversion:

- (5) a. [NP [IP *oogoede* *Mary-ga/no* *waratta*] *toki*]-o
 loudly -nom/gen laughed time-acc
 oboeteimasu ka?
 remember Q
 'Do you remember the time when Mary laughed loudly?'
- b. [NP [IP *oogoede* *Mary-ga/*no* *waratta*] *toki*] *John-ga*
 loudly -nom/gen laughed time -nom
 naiteita.
 was crying
 'John was crying when Mary laughed loudly.'

In (5a) the NP headed by *toki* "time" is an argument, and Case alternation is allowed; while in (5b) the NP is an adjunct, and the embedded subject cannot have genitive Case. Based on this, he argues that given the assumption that genitive Case is checked in NP SPEC (by adjunction to N'), the impossibility of genitive Case in (5b) follows if adjunction to adjuncts is prohibited.

Second, Takahashi also shows that adjunction to derived subjects is prohibited based on the *que/qui* alternation in French. He assumes with

Sportiche 1988 that in French subjects obligatorily raise from inside VP to IP SPEC in overt syntax. In French the complementizer *que* must be realized as *qui* when the subject of its complement undergoes A'-movement, and otherwise as *que*, as shown in (6):

- (6) a. Qui crois-tu [CP qui/*que [IP \bar{t} est parti]]?
 who think-you that has left
 'Who do you think left?'
 b. Quel livre crois-tu [CP *qui/que [IP Jean a acheté \bar{t}]]?
 which book think-you that has bought
 'Which book do you think that Jean bought?'

Following Rizzi 1990, Takahashi assumes that the alternation is a reflection of agreement between the COMP and what moves to the SPEC of the COMP. Under the assumption that specifiers are created by adjunction, the alternation stems from adjunction of a wh-phrase to C'.

He then considers the examples in (7) from Déprez 1989:

- (7) a. Je crois [CP que [IP [CP que Jean a rencontré Marie] ennue
 I think that that has met bores
 Pierre]].
 'I think that that Jean met Marie bores Pierre.'
 b. *Quel homme crois-tu [CP que [IP [CP que/qui [IP \bar{t} a
 which man think-you that that has
 rencontré Marie] ennue Pierre]]?
 met bores
 '*Which man do you think that that \bar{t} met Marie bores Pierre?'
 c. ??Quel homme crois-tu [CP que [IP [CP que Jean a
 which man think-you that that has
 rencontré \bar{t}] ennue Pierre]]?
 met bores
 '??Which man do you think that that Jean met \bar{t} bores Pierre?'

(7b), which is derived from (7a), involves extraction of a subject wh-phrase out of a sentential subject introduced by COMP, and the alternation is impossible. Note that (7b) is totally ungrammatical and worse than merely a Subjacency violation such as (7c), which involves extraction of an object wh-phrase out of the sentential subject. If in (7b) the subject wh-phrase could adjoin to C' of the sentential subject on the way to its final destination, (7b) should be as bad as (7c). Thus, the ungrammaticality of (7b) is evidence that adjunction to derived subjects is banned.⁴

Therefore, the aggregate evidence presented above points to the conclusion that adjunction to non-L-marked phrases is prohibited. Given this, it is natural to assume that adjunction to a projection of a non-L-marked head is banned, since

the head of a non-L-marked phrase is not L-marked either. Assuming this to be the case, all of the examples in (2) are straightforwardly explained. In the grammatical examples, INFL adjoins to an L-marked COMP in LF without causing any violation. In the ungrammatical examples, on the other hand, INFL adjoins to a non-L-marked head in LF, violating the ban against adjunction to a projection of a non-L-marked head.⁵

Finally, the dialectal variations exhibited in (2) may be explained as follows. First, consider (2a) containing the overt complementizer *that*, which all dialects accept. Since this COMP projection is L-marked, adjunction of INFL to the head C does not violate the aforementioned ban, and so (2a) is correctly predicted to be grammatical. Alternatively, consider (2a) without *that*. Boskovic 1996 has proposed that a clause that can be headed by *that* but for which the *that* does not appear in the overt syntax is actually an IP rather than a CP. Let us assume this to be the case in those dialects which do not accept embedded topicalization in the absence of *that*. In this case, the complement clause would be IP, consequently there would be no C to enter into a checking relation with INFL, and therefore (2a) without *that* would be correctly ruled out for these dialects. On the other hand, for those dialects which do accept (2a) without *that*, we can assume that these speakers have lexical entries which may subcategorize for a CP headed by a null COMP, and it is this null COMP to which the INFL covertly raises in order to license embedded topicalization. Second, consider the data in (2c) and (2d), which our American speakers did not accept but our British consultants did. It may be that for those speakers who accept these data, these clauses are analyzed as L-marked complements as opposed to non-L-marked arguments or adjuncts.

It is standardly assumed that lexical entries contain information about theta-role assignment (which is related to the property of L-marking) and subcategorization frames (which may specify selectional restrictions on the grammatical category of an argument or some property related to the head of that argument). Since the lexicon is the locus of dialectal and speaker idiosyncrasy, it is not surprising that some variation might be found along these lines.

3. Japanese

Let us next consider embedded topicalization in Japanese. In Japanese a topic is followed by the particle *wa* and appears in the clause-initial position, as shown in (8):

- (8) a. John-wa kono hon-o yonda.
 -top this book-acc read
 'As for John, he read this book.'

- b. Kono hon-wa John-ga yonda.
 this book-top -nom read
 'As for this book, John read it.'

If a *wa*-phrase appears in a clause-internal position, as in (9), it cannot be interpreted as a topic of the clause, but it instead carries a contrastive meaning:

- (9) John-ga kono hon-wa yonda.
 -nom this book-top read
 'John read this book, as opposed to some other book.'
 '*As for this book, John read it.'

See Hoji 1985, among others, for a study of contrastive *wa*.

Ueyama 1989, 1994 and Sato-Zhu and Larson 1992 point out that Japanese topic phrases show the same pattern as English ones in embedded clauses. Let us consider the Japanese counterparts of (2a-f) in turn below.

First, embedded topicalization is possible in complement clauses of bridge verbs, as shown in (10):⁶

- (10) a. John-wa [kono hon-wa/o Mary-ga yonda to]
 -top this book-top/acc -nom read COMP
 sinziteiru.
 believe
 'John believes that this book, Mary read.'
 b. John-wa [Mary-wa/ga kono hon-o yonda to]
 -top -top/nom this book-acc read COMP
 sinziteiru.
 believe
 'John believes that Mary read this book.'

In (10a) the object of the embedded clause *kono hon* "this book" is topicalized, and the example is good. In (10b) the subject of the embedded clause *Mary* is topicalized, and the example is also good.

Second, embedded topicalization is also possible in interrogative clauses, as shown in (11):^{7, 8}

- (11) a. John-wa [kono hon-wa/o Mary-ga yonda kadooka]
 -top this book-top/acc -nom read whether
 siri tai to omotteiru.
 know want COMP think
 'John wonders whether this book, Mary read.'

- b. John-wa [Mary-wa/ga kono hon-o yonda kadooka]
 -top -top/nom this book-acc read whether
 siri tai to omotteiru.
 know want COMP think
 'John wonders whether Mary read this book.'

In (11a) the embedded object is topicalized, and in (11b) the embedded subject is topicalized.

Third, embedded topicalization is impossible in complement clauses of factive verbs and noun-complement clauses, as shown in (12) and (13):

- (12) a. John-wa [kono hon-*wa/o Mary-ga yonda no]-o
 -top this book-top/acc -nom read COMP-acc
 kookaisiteiru.
 regret
 'John regrets that this book, Mary read.'
- b. John-wa [Mary-*wa/ga kono hon-o yonda no]-o
 -top -top/nom this book-acc read COMP-acc
 kookaisiteiru.
 regret
 'John regrets that Mary read this book.'
- (13) a. John-wa [kono hon-*wa/o Mary-ga yonda to]-no
 -top this book-top/acc -nom read COMP-gen
 uwasa-o sinziteiru.
 rumor-acc believe
 'John believes the rumor that this book, Mary read.'
- b. John-wa [Mary-*wa/ga kono hon-o yonda to]-no
 -top -top/nom this book-acc read COMP-gen
 uwasa-o sinziteiru.
 rumor-acc believe
 'John believes the rumor that Mary read this book.'

In the a-examples the embedded object is topicalized, and in the b-examples the embedded subject is topicalized. All of these examples are ungrammatical, parallel to the judgments of the American speakers as stated above. Note, however, that if the particle *wa* is interpreted instead as a contrastive marker, all of the above Japanese examples become grammatical.

Fourth, and finally, embedded topicalization is also impossible in an adjunct clause and in a sentential subject, as shown in (14) and (15):

- (14) a. [Kono hon-*wa/o Mary-ga yomu maeni], John-wa
 this book-top/acc -nom read before -top
 sudeni yondeita.
 already had read
 '*Before this book, Mary read, John had already read it.'
- b. [Mary-*wa/ga kono hon-o yomu maeni], John-wa sudeni
 -top/nom this book-acc read before -top already
 yondeita.
 had read
 'Before Mary read this book, John had already read it.'
- (15) a. [Kono hon-*wa/o Mary-ga yonda no]-wa hontoo da.
 this book-top/acc -nom read COMP-top true be
 '*That this book, Mary read is true.'
- b. [Mary-*wa/ga kono hon-o yonda no]-wa hontoo da.
 -top/nom this book-acc read COMP-top true be
 'That Mary read this book is true.'

Just as in (12) and (13), the a-examples above involve topicalization of the embedded object, the b-examples involve topicalization of the embedded subject, and all of these examples are ungrammatical. Again, if the particle *wa* is interpreted as a contrastive marker, these examples too become grammatical.

Thus, Japanese embedded topicalization has exactly the same restrictions as English embedded topicalization, modulo some minor variations found in certain English dialects as discussed earlier.⁹ Therefore, it is natural to expect that these restrictions should follow from principles allowed by UG. Given the analysis of English embedded topicalization developed above, the same analysis should also be applied to Japanese embedded topicalization. Therefore, we can posit that Japanese embedded topicalization similarly involves IP adjunction and LF movement of some element to the embedded COMP.

Let us now consider what actually moves to the embedded COMP in LF. In Section 2 we tentatively assumed that among the candidates in (3), repeated here as (16), it is INFL which moves to COMP:

- (16) a. a feature in the topic
 b. a feature in INFL
 c. INFL

The question is whether a relevant feature moves or the category INFL moves in LF. Travis 1984, among others, shows that head movement is strictly local in such a way that a head cannot move across another head. On the other hand, Maki 1995 shows that feature movement is not local, and a feature may move to its target across an island (in the sense of Ross 1967) unless there is an intervening feature that can contribute to the checking of the target feature. For instance, he argues that in examples such as (17), which are possible in

languages like Japanese, the *wh*-feature of the *wh*-phrase in a complex NP moves to the matrix COMP to check off the feature of the matrix COMP. See Kuno 1973, Huang 1982, Nishigauchi 1986, and Watanabe 1992, among others, for analyses of *wh*-in-situ.

- (17) kimi-wa [NP [IP nani-o katta] hito]-ni atta no?
 you-top what-acc bought man-to met Q
 '*What did you meet the man who bought?'

With this in mind, let us consider the examples in (18) and (19):

- (18) * John-ga [NP [IP kono hon-wa pro yonda] hito]-ni atta.
 -nom this book-top read man-to met
 '*John met the man who this book, read.'
- (19) * Mary-ga [John-ga [NP [IP kono hon-wa pro yonda]
 -nom -nom this book-top read
 hito]-ni atta to] sinziteiru.
 man-to met COMP believe
 '*Mary believes that John met the man who this book, read.'

(18) has a topic in a relative clause and is ungrammatical. We are assuming with Murasugi 1991 that Japanese relative clauses are IPs. The ungrammaticality of (18) is expected, since there is no COMP that can license the relevant feature in the topic or INFL. (19) contains (18) as an embedded clause, and again the example is ungrammatical. Note, however, that (19) does have an L-marked COMP which is potentially able to license the relevant feature in the topic or INFL. Suppose that what moves to COMP is the feature in the topic or INFL. Based on Maki 1995, the feature should be able to move to the embedded COMP in LF, and example (19) therefore would incorrectly be ruled in. On the other hand, suppose that what moves to COMP is instead INFL. According to Travis 1984, INFL cannot move to the embedded COMP across a complex NP, and as such this example will correctly be predicted to be ungrammatical. Hence, it must be the case that in embedded topicalization it is INFL which moves to COMP in LF.

Before concluding, let us discuss an implication of the above analysis.¹⁰ If the present hypothesis is correct, it suggests that INFL and COMP are responsible for embedded topicalization, and there is no strong motivation to assume an independent functional category for this construction. Sato-Zhu and Larson 1992 argue for a new functional category Top. As pointed out above, postulation of such a head would incorrectly predict examples such as (1b) to be grammatical. Ueyama 1989 also proposes a new functional category M, which is realized as the Japanese complementizer *to* "that" and is distinct from an interrogative COMP. In Ueyama's system a topic is licensed by *to*. However,

since examples such as (ia) in footnote 8, repeated here as (20), are grammatical without *to*, Ueyama's hypothesis cannot be maintained as is:

- (20) John-wa [kono hon-wa/o Mary-ga yonda kadooka] sitteiru.
 -top this book-top/acc -nom read whether know
 'John knows whether this book, Mary read.'

Therefore, the embedded topicalization construction should not involve an independent functional category such as Top or M.

4. Conclusion

In this paper we have reached the conclusion in (21):

- (21) Embedded topicalization requires two kinds of licensing:
 a. A topic is licensed in the projection of INFL; and
 b. INFL is licensed by adjoining to COMP in LF.

We derived restrictions on embedded topicalization from the ban against adjunction to a projection of a non-L-marked head. Then, we argued that given the proposed analysis, there is no motivation to assume an independent functional category such as Top or M for embedded topicalization.

Notes

¹ Certain aspects of the section on English are based on an earlier paper by Maki and Kaiser (in press). The interested reader is referred to that work for discussion of related topics which will not be explored in depth here (e.g., the relation between embedded topicalization and negative inversion, deriving the correct word order of the embedded topic and subject, etc.).

We would like to thank Zeljko Boskovic, Howard Lasnik, Neil Smith, Daiko Takahashi, and some anonymous reviewers for their helpful comments. For a couple of the English examples, the judgments of the British reviewers differed from those of our American consultants. Such differences are noted in the text along with a possible explanation for these dialectal variations. Needless to say, all errors are our own.

¹ At this point we leave the question open as to which of the two has a feature to be checked off.

² Egashira 1997 proposes the same account independently, which we noticed in the course of revising this paper. However, he has not discussed restrictions on

embedded topicalization. Since this paper deals extensively with those, this research is independent of his.

³ Neither our American nor British consultants accept embedded topicalization in an adjunct clause or in a sentential subject. However, embedded topicalization in a sentential subject is subject to some dialectal variation within American English. While it is not accepted in Authier (1992: 332), it is in Lasnik and Saito (1992: 77). This dialectal variation remains unexplained under the general hypothesis developed here. We leave this intriguing issue for further research.

⁴ The *que/qui* alternation in French also constitutes evidence for the ban against adjunction to adjuncts. Suppose with Stowell 1981 and Grimshaw 1990 that factive complements are adjuncts. Then, the fact that *qui* is impossible in (ib) suggests that adjunction to adjuncts is disallowed. We owe these data to Zeljko Boskovic (personal communication):

- (i) a. Jean regrette que Marie a lu le livre.
 regret that read the book
 'Jean regrets that Marie read the book.'
 b. * Qui Jean regrette-t-il qui \bar{t} a lu le livre?
 who regret that read the book
 '*Who does Jean regret that \bar{t} read the book?'

⁵ The proposed analysis is also relevant for negative inversion in embedded contexts. Hooper and Thompson 1973, Authier 1992, and Watanabe 1993, among others, observe that embedded topicalization and embedded negative inversion are allowed in the same contexts. Namely, negative inversion is possible in the complement clause of a bridge verb, as in (ia), but not in the complement clause of nouns, as in (ib), for example:

- (i) a. John believes that at no time would Mary agree to visit him.
 b. * John believes the rumor that at no time would Mary agree to visit him.

Unlike topicalization, negative inversion is accompanied by inversion of the subject and auxiliary verb (AUX). Given the assumption that a head moves to a head position, AUX should move to a some head. For the sake of discussion, let us assume with Authier 1992 and Watanabe 1993 that AUX moves to COMP with the inverted element moving to CP SPEC in overt syntax. If negative inversion did not involve any other operation, there would be no way to account for the contrast in (i). However, the fact that embedded topicalization and embedded negative inversion take place in the same contexts suggests that the LF movement proposed for embedded topicalization should also apply to embedded negative inversion. If this is the case, embedded negative inversion also involves two kinds of licensing: 1) an inverted element is licensed in the projection of COMP; and 2) COMP is licensed by adjoining to the higher COMP in LF. Given this and the restriction on adjunction, the contrast in (i) is correctly accounted for.

Note, however, that as discussed earlier in this section, embedded topicalization cannot be directly incorporated into the same analysis as embedded negative inversion (i.e., the CP recursion analysis), since this would incorrectly predict examples such as (1b) to be grammatical.

⁶ Unlike English, the Tokyo dialect of Japanese does not allow COMP deletion. Thus, the examples in (10) are ungrammatical without *to* "that". On the other hand, as Saito 1987 discusses, the Osaka dialect of Japanese does allow COMP deletion in colloquial speech. COMP deletion easily takes place with bridge verbs such as *yuu* "say" and *omoo* "think". Thus, embedded topicalization is possible without COMP in the Osaka dialect, as shown in (i):

- (i) a. John-wa [kono hon-wa/o Mary-ga yonda] yuuta/omooteru.
 -top this book-top/acc -nom read said/think
 'John said/thinks that this book, Mary read.'
- b. John-wa [Mary-wa/ga kono hon-o yonda] yuuta/omooteru.
 -top -top/nom this book-acc read said/think
 'John said/thinks that Mary read this book.'

Therefore, the Osaka dialect has a null COMP to which the INFL covertly raises in order to license embedded topicalization, just as the dialects of English which accept (2a) without *that*.

⁷ Japanese does not have a verb which expresses the meaning of the English verb *wonder* in one word. The closest counterpart of *wonder* is made out of a set of words as in *siri-tai-to-omoo* "know-want-COMP-think".

⁸ Note that in Japanese embedded topicalization is also possible in interrogative clauses subcategorized by the verb *sitteiru* "know", as shown in (i):

- (i) a. John-wa [kono hon-wa/o Mary-ga yonda kadooka] sitteiru.
 -top this book-top/acc -nom read whether know
 'John knows whether this book, Mary read.'
- b. John-wa [Mary-wa/ga kono hon-o yonda kadooka] sitteiru.
 -top -top/nom this book-acc read whether know
 'John knows whether Mary read this book.'

On the other hand, the English counterpart of (ia), where *this book* is topicalized, is not as good as that of (11a). It is marginal in American English and almost ungrammatical in British English. At this point, we cannot provide a conclusive explanation for this. However, one possible factor behind this may be the factivity of the verb that takes the clausal complement. Suppose that the degree of factivity of a given verb varies slightly from language to language and from dialect to dialect. Then, the higher the degree of factivity, the less possible embedded topicalization would be. Given that example (2c), which has a factive verb, is better in one dialect of English than in another. If the factivity of the verb *know* is low in Japanese and high in British English, the variation in grammaticality with respect to (ia) will follow.

⁹ Note that Japanese does not have the dialectal variations with respect to embedded topicalization as found in English, and the grammaticality judgments of the Japanese examples indicate that Japanese behaves in the same way regarding embedded topicalization as the American dialect of English stated above.

¹⁰ Maki and Kaiser in press explore further implications. They discuss three points, which are summarized below. First, the present approach suggests that INFL in English may have multiple SPECs for a derived subject and a topic. This in turn suggests that a functional head may have multiple SPECs even in languages like English depending on the nature of the head.

Second, if adjunction to a projection of a non-L-marked head is prohibited, Japanese wh-constructions must involve overt wh-feature movement. Maki 1995, reinterpreting Nishigauchi's 1986 LF wh-phrase movement hypothesis in terms of the Minimalist Program, proposes that in Japanese wh-constructions wh-feature movement takes place in LF. However, the LF wh-feature movement hypothesis would incorrectly also rule out concessive clauses in Japanese such as (i):

- (i) [CP dare-ga kite mo], ii desu.
 who-nom come COMP good be
 'It is OK, no matter who comes.'

A concessive clause counts as an adjunct at the point when it is introduced into the phrase structure by generalized transformation. Hence, if the wh-feature in (i) moved to COMP in LF, it would adjoin to a non-L-marked head, and thus the example would be incorrectly ruled out. Therefore, wh-feature movement in Japanese must take place in overt syntax, since a concessive clause does not count as an adjunct before it is adjoined to the main clause by generalized transformation.

Third, and finally, examples such as (17) suggest that a feature must move to the target in one step without adjoining to any intervening heads. If the wh-feature of the wh-phrase in the relative clause moved to the target by adjoining to the intervening heads, it would necessarily adjoin to the head of the relative clause INFL, which is not L-marked, and thus (17) would incorrectly be predicted to be ungrammatical. Hence, when a feature moves, it must move to the target in one step without adjoining to any intervening heads.

References

- Authier, M. 1992. "Iterated CPs and embedded topicalization", *Linguistic Inquiry* 23: 329-336.
 Baker, C. L. 1970. "Notes on the description of English questions: The role of an abstract question morpheme", *Foundations of Language* 6: 197-219.
 Baltin, M. 1982. "A landing site theory of movement rule", *Linguistic Inquiry* 13: 1-38.
 Boskovic, Z. 1996. "Selection of infinitival complements", *Natural Language and Linguistic Theory* 14: 269-304.
 Chomsky, N. 1986. *Knowledge of Language*. New York: Praeger.

- Chomsky, N. 1993. "A minimalist program for linguistic theory." In: K. Hale, S. J. Keyser (eds.), *The View from Building 20*. Cambridge, Massachusetts: MIT Press, 1-52.
- Chomsky, N. 1994. "Bare phrase structure". *MIT Occasional Papers in Linguistics* 5. Cambridge, Massachusetts: MITWPL.
- Chomsky, N. 1995. *The Minimalist Program*. Cambridge, Massachusetts: MIT Press.
- Déprez, V. 1989. *On the Typology of Syntactic Positions and the Nature of Chains*. Ph.D. Dissertation, MIT.
- Egashira, H. 1997. "Topicalization and relativization in minimalist syntax", *English Linguistics* 14: 28-51.
- Fujita, N. 1988. "Genitive subject in Japanese and universal grammar." Ms., Ohio State University.
- Fukui, N. and M. Saito. 1992. "Spec-head agreement, X'-compatibility, and optional movement." Ms., University of California, Irvine and University of Connecticut.
- Grimshaw, J. 1990. *Argument Structures*. Cambridge, Massachusetts: MIT Press.
- Hoji, H. 1985. *Logical Form Constraints and Configurational Structures in Japanese*. Ph.D. Dissertation, University of Washington.
- Hooper, J. and S. Thompson. 1973. "On the applicability of root transformations", *Linguistic Inquiry* 4: 459-497.
- Huang, C.-T. J. 1982. *Logical Relations in Chinese and the Theory of Grammar*. Ph.D. Dissertation, MIT.
- Kayne, R. 1994. *The Antisymmetry of Syntax*. Cambridge, Massachusetts: MIT Press.
- Kuno, S. 1973. *The Structure of the Japanese Language*. Cambridge, Massachusetts: MIT Press.
- Lasnik, H. and M. Saito. 1992. *Move a*. Cambridge, Massachusetts: MIT Press.
- Maki, H. 1995. *The Syntax of Particles*. Ph.D. Dissertation, University of Connecticut.
- Maki, H. and L. Kaiser. In press. "Implications of embedded topicalization". *English Linguistics* 15: 290-300.
- Miyagawa, S. 1993. "LF case-checking and minimal link condition." Ms., MIT.
- Murasugi, K. 1991. *Noun Phrases in Japanese and English: A Study in Syntax, Learnability and Acquisition*. Ph.D. Dissertation, University of Connecticut.
- Nishigauchi, T. 1986. *Quantification in Syntax*. Ph.D. Dissertation, University of Massachusetts.
- Pesetsky, D. 1987. Wh-in-situ: movement and unselective binding. In: E. J. Reuland, A. G. B. ter Meulen (eds.), *The Representation of (In)definiteness*. Cambridge, Massachusetts: MIT Press, 98-129.
- Rizzi, L. 1990. *Relativized Minimality*. Cambridge, Massachusetts: MIT Press.
- Ross, J. R. 1967. *Constraints on Variables in Syntax*. Ph.D. Dissertation, MIT.
- Saito, M. 1987. "Three notes on syntactic movement in Japanese." In: T. Imai, M. Saito (eds.), *Issues in Japanese Linguistics*. Dordrecht: Foris, 301-350.
- Sato-Zhu, E. and R. Larson. 1992. "Topic phrases in Japanese." Ms., State University of New York at Stony Brook.
- Sportiche, D. 1988. "A theory of floating quantifiers and its corollaries for constituent structure". *Linguistic Inquiry* 19: 425-450.
- Stowell, T. 1981. *Origins of Phrase Structure*. Ph.D. Dissertation, MIT.

- Takahashi, D. 1994. *Minimality of Movement*. Ph.D. Dissertation, University of Connecticut.
- Travis, L. 1984. *Parameters and Effects of Word Order Variation*. Ph.D. Dissertation, MIT.
- Ueyama, A. 1989. "Category MP in Japanese." Ms., Kyoto University.
- Ueyama, A. 1994. "Against the A/A'-movement dichotomy." In: N. Corver, H. van Riemsdijk (eds.), *Studies on Scrambling*. Berlin: Mouton de Gruyter, 459-486.
- Ura, H. 1993. "L-relatedness and its parametric variation." Ms., MIT.
- Watanabe, A. 1992. "Wh-in-situ, subjacency, and chain formation", *MIT Occasional Papers in Linguistics* 2. Cambridge, Massachusetts: MITWPL.
- Watanabe, A. 1993. "Larsonian CP recursion, factive complements, and selection." In: A. J. Schafer (ed.), *Proceedings of the North East Linguistic Society* 23. Massachusetts: GLSA. 523-537.

Hideki Maki
 Department of Japanese Studies
 Salem-Teikyo University
 Salem, WV 26426-0500
 maki@salem.wvnet.edu

Lizanne Kaiser
 Department of Linguistics
 Yale University
 P.O. Box 208236
 New Haven, CT 06520-8236
 lizanne.kaiser@yale.edu

Masao Ochi
 Department of Linguistics
 U-145
 University of Connecticut
 Storrs, CT 06269-1145
 MAO94001@UConnVM.UConn.Edu

The DP Hypothesis and Connectedness in Specificational Sentences*

Yuki Matsuda
University of Washington

1. Introduction

This paper discusses so-called CONNECTEDNESS effects observed in SPECIFICATIONAL SENTENCES and makes the following claims: (i) the source of the obligatory connectedness effects is that it has an inverse predication structure; (ii) as a predicate, the presupposed portion in specificational sentences must assign a theta role to the focused referential DP via an operator; (iii) the presupposed portion contains a trace of operators, which is visible for the purpose of checking the binding conditions and quantifier scope.

A SPECIFICATIONAL SENTENCE is defined as a sentence that is divided into a part that states what is presupposed and corresponds to an implicit *wh*-question, and another part that is “focused” in that it provides the answer to the implicit question. *It*-clefts and pseudo-clefts in English are typical specificational sentences. Consider the pseudo-cleft sentence in (1).

- (1) [What John is] is silly. (Higgins 1973)

This sentence is two-way ambiguous. According to Higgins (1973), (1) can be either SPECIFICATIONAL or PREDICATIONAL. In a specificational reading, this sentence presupposes that John can be characterized in terms of some property and asserts that it is the property of being silly. In other words, this sentence indeed states that John is silly. Higgins argues that the free-relative clause in a specificational sentence supplies a list of items (e.g. list of John’s possible characteristics) and the focused constituent picks an item from the list (e.g. being silly). By contrast, on the predicational reading (1) asserts that John’s job or social position (e.g., being a romance novel writer) is silly and does not say anything directly about the person John.¹ On this reading, John could be a very intelligent person who happens to have a silly job or position. In contrast, John himself must be silly on the specificational reading of (1).

Akmajian (1970) and Higgins (1973) show that all specificational sentences exhibit what they call CONNECTEDNESS effects as shown in (2).

- (2) a. [What John_i was looking at] was a picture of himself_i.
b. It was a picture of himself_i [that John_i was looking at].

In (2a-b), R(eferential)-expression *John*, which is embedded inside a free relative clause in (2a) and *that*-clause in (2b), can be co-referential with the reflexive *himself*, which is located outside. Given binding Condition A, we expect this type of long distance binding of reflexives to be illicit. Indeed, the long distance binding of the reflexive is impossible in example (3).

- (3) **[What John_i was looking at] has turned out to be a picture of himself_i.*
(Higgins 1973)

What sets (2) apart from (3) is that the former is specificational but the latter is not. The term *connectedness* is used in this paper to refer to the fact that in some sentences (e.g., specificational sentence, *wh*-interrogatives) binding and scope possibilities are determined not on the basis of surface representations but on the basis of their counterparts that represent thematic relations in a more straightforward way.

Connectedness effects observed among specificational sentences are not limited to binding Condition A but also concern Conditions B and C as well. Condition B states that pronouns must be free within their governing category. To see the connectedness effect with respect to Condition B, compare the following specificational and predicational sentences.²

- (4) a. **[What Bill_i read] was a book about him_i.* (specificational)
b. *[What Bill_i read] is a book about him_i.* (predicational)

In (4a) and (4b), the binder *Bill* is contained inside a free-relative clause, and bindee *him* outside the free-relative clause. According to the Binding Theory, this configuration should not result in a violation of Condition B. However, only in predicational (4b) can the pronoun be co-indexed with *Bill*. As far as binding possibilities are concerned, (4a) behaves exactly like its non-cleft version (5) below, which has the same truth condition as (4a) in the narrow sense. (4a) and (5) differ from each other only with respect to presupposition and focus. (5) is ruled out by Condition B.

- (5) **Bill_i read a book about him_i.*

In order to preserve the standard assumptions about the Binding Theory, we must assume that (5) is the proper syntactic representation for (4a) and that the binding rules apply to (5). Then we could argue that (4a) is ruled out by virtue of the fact that (5) is ruled out by Condition B. Similarly, the example in (6) shows connectedness in specificational sentences with respect to Condition C.

- (6) a. **[What she_i was] was proud of Mary_i.*
b. **She_i was proud of Mary_i.* (Heycock and Kroch 1996)

In (6a), although *Mary* is not c-commanded by *she*, they cannot be co-referential on a par with (6b). (6b) is ruled out by Condition C. Thus, if we are to preserve the existing binding conditions, we must assume that binding conditions apply to specificational sentences at some non-surface syntactic level.

2. An Account of Obligatory Connectedness in Specificational Sentences

One important characteristic of connectedness in specificational sentences is that as far as pronominal binding is concerned it is obligatory. That is, metaphorically speaking, we must “convert” them into non-specificational counterparts and then apply the binding rules. For example, (7) is a specificational sentence, and only one interpretation of *himself* is permitted, although this sentence has two R-expressions. This means that the DP *a picture of himself* must be “moved back” to the object position of the verb *watching* before the binding conditions apply to (7).

(7) [What Bill_i thought John_j was watching t] was a picture of himself*_{i/j}.

Many English constructions exhibit connectedness effects. In some cases, the effect is obligatory. In others, it is optional. The case of *wh*-interrogatives exemplified by (8a) is a case of optional connectedness discussed by Barss (1986). On the other hand, the case of predicate preposing discussed by Barss (1986), Hoji (1989) and Huang (1993) is exemplified by (8b) and is a case of obligatory connectedness.

(8) a. [Which picture of himself_{i/k}]_j does Bill_k think [t_j John_i like t_j]?
b. [Criticize himself*_{i/j}]_k, John_i thought Bill_j would not t_k.

Examples like (8b) seem to show that predicates such as VPs and APs are subject to obligatory connectedness effects. Heycock (1995) however argues against this view by showing that some non-predicates also exhibit the same obligatory connectedness effects and claims that the relevant dichotomy is that between referential vs. non-referential expressions.

At any rate, it is clear that this type of classification of moved expressions do not explain the obligatory connectedness observed in specificational sentences because in many cases, the “dislocated expression” is clearly a nominal that is referential in nature. (9) is the case in point.

(9) [What John_i thought Bill_j liked] was *that picture of himself**_{i/j}.
(pointing at a particular picture in the room where the speaker and the hearer are located)

In (9), the focused expression, which is the “dislocated expression,” is a deictic expression and clearly refers to a particular object. Thus, we must find a different way of accounting for the connectedness effects found in specificational sentences.

I shall analyze this obligatory nature of connectedness in specificational sentences by assuming that a presupposed portion of specificational sentences is generated as a predicate. Many researchers argue that specificational sentences involve an inverse predication structure (Williams 1983, Partee 1986, Heggie 1988, Moro 1991, Guéron 1994, Matsuda 1997, Iatridou and Varlokosta 1998). For example, Williams (1983) claims that specificational pseudo-cleft sentences should be analyzed as having an inverse predication structure, as shown in (10).

(10) What S PRED NP IS XP_{SUBJECT} (specificational pseudo-cleft)

Furthermore, he argues that just like normal predicational sentences, specificational sentences are base-generated as in (11b) in which the subject c-commands its predicate.

(11)	a.	What S is XP	Predicational Sentence
	b.	<u>XP is What S</u>	Specificational Sentence
		Subject Predicate	

Williams claims that specificational pseudo-cleft sentences are base-generated as (11b) and then Subject-Aux inversion occurs when a free relative clause is preposed, as shown in (10). In fact, there are two types of specificational pseudo-cleft sentences — one is overtly inverted and the other is not, as shown in (12). By contrast, only one type of predicational pseudo-cleft sentences is available, as shown in (13).³

(12) a. [What John is] is important to himself. (specificational)
 b. Important to himself is [what John is].

(13) a. [What John is] is important to him. (predicational)
 b. *Important to him is [what John is].

Furthermore, the subject raising test suggests that the free relative clause in a specificational pseudo-clefts is indeed a predicate. Predicates cannot be raised in a subject raising construction as shown in (14).

(14) a. John is happy.
 b. John seems to be happy.
 c. *Happy seems to be John.

Unlike (14b) in which the subject is raised, (14c) is unacceptable because a predicate is raised to the subject position. With this paradigm in mind, consider the examples in (15).

- (15) a. [What John is] seems to be important to him. (predicational)
 b. *[What John is] seems to be important to himself. (specificational)
- (16) a. *Important to him seems to be [what John is]. (predicational)
 b. Important to himself seems to be [what John is]. (specificational)

(15a) is acceptable because the subject of a predicational sentences is raised. In contrast, (15b) is not acceptable. This sentence shows that what is raised in this example is not a subject. (16a) is unacceptable because the predicate in a predicational sentences is raised. In contrast, (16b) is acceptable. This example shows that the focused phrase in specificational sentences is indeed a subject, which in turn supports Williams' claim that all specificational sentences are base generated as in (11b).

Further support for the inverse predication structure posited for specificational sentences comes from the examples in (17) and (18) discussed by Moro (1990).

- (17) a. [NP The photograph of the president] was [NP the cause of the riot].
 b. What_i do you think [NP the photograph of the president] was [NP the cause of t_i]?
- (18) a. [NP The cause of the riot] was [NP the photograph of the president].
 b. *What_i do you think [NP the cause of the riot] was [NP the photograph of t_i]?

The intended interpretation of (17a) here is a predicational one. By contrast, the intended interpretation of (18a) is a specificational one in that the first definite NP describes the "presupposed portion" and the second definite NP the focus. That is, (18a) presupposes that there is a unique cause of the riot and asserts that it is the photograph of the president. Note that (17b) is well-formed, whereas (18b) is ill-formed. If we follow Williams' proposal, (17a) and (18a) differ from each other in the following respects: In (17a), the first NP is the subject and the second NP is the predicate since it is a normal predicational sentence. On the other hand, in (18a), the first NP is the (underlying) predicate, and the second NP the (underlying) subject. If so, the above data receive a simple account: a *wh*-phrase can be extracted from a predicate as in (17b) but cannot be extracted from a subject NP as in (18b). According to Moro, this in turn follows from the generally understood properties of the subject.

Following Williams and others, let us assume that specificational sentences have D-structure configurations schematically represented as in (11b). For the purpose of exposition, let us take (12a) as an example. This sentence has a D-structure configuration given in (19). I assume with Chomsky (1977), Hoji

(1987), Heggie (1988) among others that pseudo-cleft and cleft sentences involve an operator movement. A *wh*-operator is involved in pseudo-clefts, and a null operator movement is involved in *it*-clefts. That is, (19) involves a *wh*-operator movement from the predicate trace position to the Spec of CP position.

(19) [VP[_{AP} Important to himself]_j]_i[V' is [CP what_i John_j is t_i]]]

On this analysis, (19) is an instance of an ordinary predication structure in that the focused phrase is a subject and the free relative clause is a predicate. The subject receives a theta role from the free relative clause in this configuration via theta-role transmission. At this point, I posit the principle in (20) to account for the connectedness effects found in specificational sentences.

(20) When a predicate is a complex one involving an operator, assume that the trace that is co-indexed with its argument and is the tail of the chain actually is identified by the argument when the binding and scope principles apply.

For instance, we should pretend that (19) looks like (21) when the binding principles apply.

(21) [VP[_{AP} Important to himself]_j]_i[V' is [CP what_i John_j is
[_{AP} Important to himself_j]]]]

Condition A applies to (21) and licenses it because *John* c-commands *himself* (the lower occurrence) within its governing category. This in turn licenses the higher occurrence of *himself* as well as being co-indexed with *John*. This accounts for the obligatory connectedness phenomenon in specificational sentences.

3. A Problem with Headed Relatives

It is however too early to conclude that we can account for the connectedness in specificational sentences completely in terms of the above account. On the basis of examples due to Green (1971), Morgan (1973), and Kajita (1972), Higgins (1973) argues that specificational sentences cannot be derived by a syntactic transformation because some examples simply do not have a putative D-structure source in which the focused expression occupies an argument position of the main predicate in the free relative. Higgins presents (22a–b) to demonstrate a parallel with respect to connectedness between pseudo-cleft sentences and copulative sentences, whose presupposed portion is a definite NP. The problem is that even though (22a) lacks a gap for the focused NP, connectedness is observed in this sentence.⁴

- (22) a. [NP The approach [CP you_i should try instead]] is shaving yourself_i in the evenings.
 b. [CP What you_i should try instead] is shaving yourself_i in the evenings.

One could for example maintain that (22b) is derived from a base sentence like (23).

- (23) [NP Shaving yourself_i in the evenings]_j is [CP what_j you_i should try t_j instead].

As mentioned above, the trace in the free relative can be regarded as a copy of its original for the purpose of checking the binding conditions and the scope principle. Thus, a copy of *shaving yourself in the evenings* is found in the object trace position of *try* in (23). Consequently, the second person pronoun *you* can be co-referential with *yourself*. However, such derivation is not possible with (22a). Given that the focused NP is the (underlying) subject, we expect (24) to be its D-structure form. As shown in (24), it would be most natural to regard the whole relativized definite NP as a closed expression (a referential expression) rather than a predicate.

- (24) [NP Shaving yourself in the evenings] is [NP the approach_j [CP Op_j you_i should try t_j instead]] .

This means that there is no gap to which the focused NP, *shaving yourself in the evenings*, is related. Thus, there is no way for the focused NP to be “connected” with a position inside the relative clause. Using this type of example as evidence, Higgins argues against any transformational analysis of cleft and pseudo-cleft sentences.

However, the fact that (22a) has an inverse structure counterpart as shown in (24) suggests that this relativized NP can be a predicate. Recall that only specificational sentences have a reversed structure counterpart. If so, (22a) is a specificational sentence, and the definite NP, *the approach you should try instead*, in (22b) must be a predicate in the sense delineated above.

4. Two Types of DPs and Connectedness

4.1. Structural difference between referential and predicative DPs

Williams (1994) presents examples (25a-b) to show that definite NPs can be used as predicates.

- (25) a. I consider John the mayor.
b. I consider the mayor John.

Rapoport (1987) points out that small clauses such as the ones in (25) must contain a subject as the first expression and a predicate as the second expression.. For example, (26b) is ill-formed because the small clause has a deictic expression in the predicate position. A deictic expression is always a designator and can never be a predicate.⁵

- (26) a. I consider that man my first teacher of linguistics.
b. *I consider my first teacher of linguistics that man.

The contrast between the acceptable (26a) on one hand and the unacceptable (26b) alone suggests that definite NPs, but not deictic NPs, can be a predicate. Williams points out that (25a) and (25b) have distinct interpretations. (25a) is used when the speaker knows the person who bears the name *John*, and this sentence says that there is a unique individual who is a mayor and that *John is the unique individual who is a mayor*. In this case, the expression *the mayor* is a description of what John is. By contrast, (25b) is used when the speaker only knows that there is a unique individual who bears the name *John*, and this sentence says that the mayor who the speaker knows bears this name. Therefore in (25b) the expression *John* is a description of what the mayor is.

If the entire definite NP in (22a) presented in the last section is a predicate, then we can account for the connectedness observed in this example on a par with (22b). In order to recognize the structural differences between referential and predicational definite NPs, I will adopt a modified version of Longobardi's (1994) proposal.⁶ I argue that a DP that originates in a predicate position has the nominal structure at LF as shown in (27).

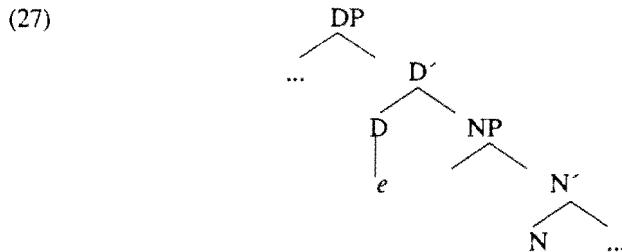

Let us refer to predicative definite NPs as *predicative DPs*, and referential definite NPs as *referential DPs*.⁷ As shown in (27), D is not occupied by N in predicative DPs. By contrast, referential DPs, which cannot be found in a predicate position, are represented as in (28).

(28)

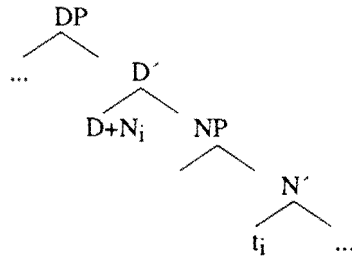

Thus with this analysis of DP structure, the semantic difference between referential and predicational DPs is represented as a structural difference between (27) and (28), respectively.

I further assume that referential features are specified in the lexicon. That is, nouns bear the features [\pm referential] and [\pm quantificational]. When an N head is occupied by a nominal with a [+referential] or [+quantificational] feature, it must move to D. By contrast, when an N is occupied by a nominal with [-referential] and [-quantificational] features, then it cannot move to D and must stay in N. As a result of N's movement to D, the whole DP inherits from N a referential or quantificational feature. I assume that these referential and quantificational DPs constitute a blocking category. By contrast, predicative DPs do not inherit any referential features, and therefore they are not considered to be a blocking category for predication. This is why the DP *the approach you should try instead* in (22a) (repeated here as (29)) can serve as a predicate containing a null operator, which is then identified by the focused referential DP.

(29) [DP The [NP approach [CP you_i should try instead]]] is [DP shaving yourself_j in the evenings].

According to our proposal, a specificational sentence has an inverse predication structure, and the constituent that carries presupposed information is born as a predicate. Since the entire predicative DP in (29), *the approach you should try instead*, originates as a predicate, the gap within the DP is not saturated by the definite determiner *the*. Rather, as shown in (30) below, the null operator moves up to the Spec of NP, and the focused DP identifies the null operator in the Spec of NP which in turn identifies the trace at the tail of the chain. According to this analysis, the internal structure of (29) is given as in (30).

(30) [VP [DP Shaving yourself_j]_i] is [V' [DP the [NP Op_i [N' approach_j [CP t_i you_j should try t_i instead]]]]]

According to (20), we can conclude from (30) that the trace inside the relative clause is a copy of *shaving yourself*, and the relative head, *approach*, is a predicate modifier. When the binding conditions apply to (30), the referential pronoun *you* indirectly c-commands the reflexive *yourself* within its governing

category. Therefore, *yourself* and *you* must be co-referential. In this way, the connectedness observed in (22) and in similar examples is accounted for. (31) shows how (30) is interpreted.⁸

- (31)
1. the $\Rightarrow \lambda P \iota x [P(x)]$
 2. $Op_i [N' \text{ approach}_i [CP \ t_i \ \text{you}_j \ \text{should try } t_i \ \text{instead}]] \Rightarrow \lambda y [y \text{ is an approach \& you should try } y \ \text{instead}]$
 3. $[DP \ \text{the } Op_i [N' \ \text{approach}_i [CP \ t_i \ \text{you}_j \ \text{should try } t_i \ \text{instead}]]] \Rightarrow \lambda P \iota x [P(x)] (\lambda y [y \text{ is an approach \& you should try } y \ \text{instead}])$
 4. $\iota x [x \text{ is an approach \& you}_j \ \text{should try } x \ \text{instead}]$
 5. Shaving yourself $\Rightarrow \lambda z [z = \text{shaving yourself}_j]$
 6. $[\text{VP} [NP \ \text{Shaving yourself}_j]_i \text{ is } [\text{V}' [DP \ (\text{the}) Op_i [N' \ \text{approach}_i [CP \ t_i \ \text{you}_j \ \text{should try } t_i \ \text{instead}]]]]] \Rightarrow \lambda z [z = \text{shaving yourself}_j] (\iota x [x \text{ is an approach \& you}_j \ \text{should try } x \ \text{instead}])$
 7. $\iota x [x \text{ is an approach \& you}_j \ \text{should try } x \ \text{instead}] = \text{shaving yourself}_j$

Although the definite determiner is an expletive in the syntax, it contributes to semantic interpretation. Given the way the iota operator is interpreted, the definite DP induces an existential presupposition characteristic of a specificational sentence.⁹

In conclusion, the proposal we defend not only accounts for the fact that *it*-clefts and pseudo-cleft sentences exhibit an obligatory connectedness effect, but also accounts for the fact that specificational sentence with a relative clause that describes what is presupposed exhibits an obligatory connectedness effect. This is so because in all specificational sentences, a predicative DP is born as a predicate.

4.2. Connectedness and the scope of operators.

This analysis also explains why connectedness with respect to the interpretation of various operators is observed in all specificational sentences but not in predicational sentences. Let us consider some Japanese examples that involve quantificational DPs. Consider (32a), which is a specificational sentence, and (32b), which is a predicational sentence. As we have seen, only specificational sentences demonstrate connectedness.¹⁰

- (32) a. $[DP [CP [DP \ \text{photondo-no depaato}]_j \text{-ga taiseitu-ni suru no}] \text{-wa}$
 most-GEN dept. store-NOM treasure do NC-TOP
 $[DP \ \text{soko}_j \text{-no kotei-kyaku}] \ \text{da.}$
 it -GEN regular-customer COP

' $[DP \ \text{The one that } [DP \ \text{most department stores}]_j \ \text{treasure}] \ \text{are their;}$
 regular customers.'

b. ?*[DP[CPphotondo_i-no depaato-ga taisetu-ni suru] no] -wa
 soko_i-no katarogu-ga suki da P
 catalogue-NOM like COP

'*[DPThe one that {DP most department stores}_i treasure] like their;
 catalogues.'

We can account for the fact that connectedness is observed in (32a) but not in (32b) because (32a) is base generated as in (33). (32b) is not.

(33) [VP[DPsoko_i-no kotei-kyaku] [V· [DP[NPOp_j] [CP t_j] [DPphotondo-no
 it -GEN regular customer most-GEN
 depaato]_i-ga t_j taisetu-ni suru] no]] da]
 dept. store-NOM treasure do COP

The predicative DP is born as a predicate. In this way, the referential DP in the VP Spec position can identify the null operator. Subsequently, the gap in the NP in (33) is understood to be a copy of the DP in the Spec of VP position according to (20). At this point, *hotondo-no depaato* 'most department stores' and *soko* 'its' can be co-indexed (though this is not obligatory).

In order to obtain the bound variable interpretation observed in (32a), however, the quantifier *hotondo-no depaato* 'most department stores' must be moved to a position from which it can bind the variable *soko-no* 'its' at LF. This requirement is not imposed on referential expressions that we have been considered so far. As long as a binder and a bindee are co-indexed when the binding conditions are checked, the desired co-referential interpretation is obtained. However, in case of quantified antecedents, receiving the same index with a variable is not enough to produce the required bound variable interpretation. Quantified antecedents must c-command a variable at LF (May 1985, Hoji 1997).

I argue that just as the tail of the chain in (30) is "visible" for the purpose of co-indexing, the tail of the chain is "visible" for scope interpretation. That is, in (34) below, the quantified expression within the relative clause undergoes a quantifier raising at LF and adjoins to IP inside the relative clause. A bound variable interpretation is available in (34) because the raised quantifier c-commands the tail of the chain at LF.

(34) [DP[NPOp_i] [CP [IP [DPphotondo-no depaato]_j-ga [IP t_j t_j taisetu-ni suru]
 most-GEN dept. store-NOM treasure do
 no]-wa [DPsoko_j-no kotei-kyaku]_i da]].
 NC-TOP it -GEN regular customer COP

'The ones that {DP most department stores}_j treasure are their_j regular customers.'

The following example in (35) illustrates that when a quantified expression does not c-command the tail of a chain at LF, a bound variable interpretation between the quantified expression and the pronoun in the focused position is not possible.

- (35) * $[\text{DP}[\text{NP}Op_i \text{ CP } [\text{IP } [\text{Dphotondo-no } \text{ depaato}]_j\text{-ni } [\text{IP } t_i t_j \text{ monku-o } \text{ most-GEN dept. store-DAT } \text{ complain- ACC } \text{ iu}] \text{ no}]\text{-wa } [\text{Dpsokoj-no } \text{ kotei-kyaku}]_j \text{ da}]]$.
say P -TOP it -GEN regular customer COP

'The ones that always complain to $[\text{DP } \text{most department stores}]_j$ are their $_j$ regular customers.'

Notice that the quantified expression in (35) precedes the pronoun in the focus position. Nevertheless, a bound variable interpretation is not possible in (35). This data suggests that a quantified expression will not literally be raised out of the predicative DP to take a sentential scope. Rather, (35) suggests that the dependency relationship between quantifiers and the tail of a chain must meet a syntactic principle of c-command at LF in order to obtain a bound variable interpretation.

The examples in (36) through (38) present additional evidence for our proposal regarding the contrast between predicational and specificational sentences. Akmajian (1970) and Higgins (1973) note that connectedness phenomena involve not only binding but also what Higgins call the *tense harmony*.

- (36) a. *[What John was] is very rude.
b. *[What John is] was very rude.
c. [What John is] is very rude.
d. [What John was] was very rude.
- (37) a. *[What John used to be] is very rude.
b. [What John used to be] was very rude.
- (38) a. *It is a history book that John bought.
b. It was a history book that John bought.

(36a) and (36b) are unacceptable on their specificational interpretation. For reasons having to do with selectional restrictions, a predicational interpretation is excluded from (36) and (37). (36c-d) show that in specificational sentences the free-relative and the matrix clause must be in the same tense. (37a-b) illustrate the same contrast. Similarly, (38a-b) show that the matrix predicate and the embedded predicate must be of the same tense in *it*-cleft sentences as well. Under the assumption that tenses are sentential operators, we can account this tense harmony phenomenon in the following way: If the matrix tense form and the tense form in the predicative DP (i.e., the part that contains the presupposed

information) did not agree, the focused DP and the tail of the chain, which is identified by this focused DP, would be placed under different tense operators. This means that the “same DP” in the scope of different tense operators. This produces a semantic anomaly. We can say that the tense harmony requirement must be imposed on specificational sentences to avoid this undesirable outcome.

By contrast, the examples in (39) show that such a tense harmony requirement is not imposed on predicational sentences such as (39a-d).

- (39) a. [What John is] is very lucrative.
 b. [What John was] is very lucrative.
 c. [What John is] used to be very lucrative.
 d. [What John is] was lucrative.

Our analysis can also be used to account for the connectedness effect with respect to NPIs in specificational sentences such as (40).

- (40) (He bought a lot of textbooks.) What he didn't buy was any good novels.
 (Heycock and Kroch 1996)

(40) shows that a negation operator which is inside the free-relative clause can license the *any* located outside. On the assumption that the negative operator is raised at LF within the free-relative clause and c-commands the tail of the chain, which is identified by an NPI, from that position, the connectedness effect in (40) is easily explained.¹¹

5. Conclusion

In sum, this paper provided an account of so-called CONNECTEDNESS effects observed in SPECIFICATIONAL SENTENCES. My basic position is that the presupposed constituent of a specificational sentence is a predicative DP originating in the predicate position of the sentence. As a predicate, the presupposed constituent must assign a theta role to the focused referential DP via an operator. The presupposed portion contains the lowest trace of the operator, which is visible for the purpose of checking the binding conditions and scope interpretations. I have also shown that the same analysis can be extended to cases which involve predicative DPs containing headed relative clauses.

Notes

* I am indebted to James Lyle, Kaoru Ohta, and Toshiyuki Ogihara for their helpful comments and suggestions.

¹ Not every language has pseudo-cleft sentences in which a predicate is focused. Japanese is one such language, as shown in (i).

(i) * [John(-ga) t na no]-wa baka da
 -NOM COP NC-TOP silly is

Intended reading: 'What John is is silly.'

Heggie (1988) argues that unlike a *wh*-operator, a null-operator cannot be extracted from a predicate position. For this reason, *it*-cleft sentences, which is derived from a null operator movement, cannot focus a predicate.

(ii) *It is silly [Op_i that John is t_i].

Hoji (1987) argues that Japanese cleft sentences are derived via a null operator movement. If he is correct, the fact that Japanese does not have a pseudo-cleft sentence like (1) receives a natural account: unlike English, Japanese does not have a *wh*-operator compatible with predicates. See Iatridou and Varlokosta (1998) for some related discussion.

² As Higgins (1973) notes, tense agreement between matrix and embedded clauses plays an important role in distinguishing between specificational and predicational sentences. In specificational sentences, matrix and embedded tenses must agree, but such restriction is not imposed on predicational sentences. In this sense, (4a) is ambiguous and can be either specificational or predicational. The co-reference interpretation in (4a) is acceptable with a predicational interpretation. See section 4.2 for an explanation of this tense agreement phenomenon.

³ Matsuda (1997) argues that two types of Japanese specificational sentences, one is overtly topicalized and one is not, are represented identically at LF.

⁴ Bracketing is mine.

⁵ See Rapoport (1987) and Heggie (1988) for a proposal for referential hierarchy among nominal expressions and their syntactic distributions.

⁶ Vergnaud and Zubizarreta (1992) express the same idea when they contend that we need to recognize an expletive definite determiner to account for the binding facts in French inalienable possessive constructions.

⁷ Matsuda (1999) follows Heycock (1995) and argues that predicative DPs are a subset of non-referential DPs. Thus, (27) is an instance of non-referential DPs.

⁸ I assume with Partee (1986) and Heggie (1988) that the copula is a natural language correlate of a lambda operator and shifts the type of referential DPs, as indicated in #5 in (31).

⁹ I assume (i) below for the semantics of the iota operator ι

(i) For any one-place predicate P , $\iota x[P(x)]$ denotes the sole object that belongs to the extension of P , if such object exists. Otherwise, $\iota x[P(x)]$ has no denotation. Furthermore, I assume that the gerundive form *shaving yourself_j* denotes the individual correlate of the denotation of *shave yourself_j*.

¹⁰ The morpheme *no* as it appears at the end of the topic phrase in (32a) and (32b) is generally regarded as a nominalizing complementizer (NC) and a pronoun (P) respectively. Matsuda (1999) on the other hand argues that both types of *no* are Ds.

¹¹ Marc Authier (personal communication) pointed out that in order to have an NPI interpretation, a negative operator must c-command NPI items at Spell-Out (S-structure). Otherwise, we unexpectedly rule in the following unacceptable sentence.

(i) *Anyone won't come today.

Even under this syntactic constraint on NPI interpretation, our analysis can predict that (39) demonstrates the connectedness effect with respect to NPIs because the negation operator c-commands *any* at Spell-Out via the mechanism of theta-role transmission stated in (20).

References

- Akmajian, Adrian. 1970. *Aspects of the grammar of focus in English*. Doctoral dissertation, MIT, Cambridge, Mass.
- Barss, Andrew. 1986. *Chains and anaphoric dependence: on reconstruction and its implications*. Doctoral dissertation, MIT, Cambridge, Mass.
- Chomsky, Noam. 1977. "On WH-movement". In *Formal Syntax*, eds. P. Culicover, T. Wasow, and A. Akmajian. New York: Academic Press.
- Guéron, Jacqueline. 1994. "Beyond predication". In *Paths towards universal grammar: Studies in honor of Richard S. Kayne*, eds. G. Cinque, et al. Washington, D.C.: Georgetown University Press.
- Heggie, Lorie A. 1988. *The syntax of copular structures*. Doctoral dissertation, University of Southern California, Los Angeles.
- Heycock, Caroline. 1995. "Asymmetries in reconstruction". *Linguistic Inquiry* 26.4:547-570.
- Heycock, Caroline, and Anthony Kroch. 1996. "Pseudocleft connectivity: Implications for the LF interface level". *Edinburgh Occasional Papers in Linguistics* 96.1:1-34

- Higginbotham, James. 1987. "Indefiniteness and predication". In *The Representation of (In)definiteness*, eds. E. Reuland and A. ter Meulen. Cambridge, Mass: The MIT Press.
- Higgins, F.R. 1973. *The pseudocleft construction in English*. Doctoral dissertation, MIT, Cambridge, Mass.
- Hoji, Hajime. 1987. "Japanese clefts and reconstruction/chain binding effects". Paper presented at the 1997 WCCFL 6, University of Arizona, Tucson.
- Hoji, Hajime. 1989. "VP-Preposing in Japanese and its Implications", Presented at the Workshop on the VP Node in Japanese and Korean, UCLA, August 4, 1989.
- Hoji, Hajime. 1997. "Formal dependency, organization of grammar, and Japanese demonstratives". To appear in *Proceedings of Japanese/Korean Linguistics*.
- Huang, C.-T. James. 1993. "Reconstruction and the structure of VP: Some theoretical consequences". *Linguistic Inquiry* 24.1:103-138.
- Iatridou, Sabine and Spyridoula Varlokosta. 1998. "Pseudoclefts Crosslinguistically". *Natural Language Semantics* 6: 3-28.
- Longobardi, Giuseppe. 1994. "Reference and proper names: A theory of N-movement in syntax and logical form". *Linguistic Inquiry* 25.4: 609-665.
- Matsuda, Yuki. 1997. *Representation of Focus and Presupposition in Japanese*. Doctoral dissertation, University of Southern California, Los Angeles.
- Matsuda, Yuki. 1999. "The structure of Japanese nominals and syntax-semantics interface". Presented at the LSA annual meeting, Los Angeles.
- May, Robert. 1985. *Logical form: Its structure and derivation*. Cambridge, Mass: The MIT press.
- Moro, Andrea. 1991. "The raising of predicates: Copula, expletives and existence". *MIT Working Papers in Linguistics* 15:119-181.
- Partee, Barbara. 1986. "Ambiguous pseudo-clefts with unambiguous *be*". In *Proceedings of NELS* 16:354-366. GLSA, University of Massachusetts, Amherst.
- Rapoport, Tova R. 1987. *Copular, nominal, and small clauses: A study of Israeli Hebrew*. Doctoral dissertation, MIT, Cambridge, Mass.
- Vergnaud, Jean-Roger and Maria Luisa Zubizarreta. 1992. "The definite determiner and the inalienable constructions in French and in English". *Linguistic Inquiry* 23.4: 595-652.
- Williams, Edwin. 1983. "Semantic vs. Syntactic Categories". *Linguistics and Philosophy*:6:3, 423-446
- Williams, Edwin. 1994. *Thematic Structure in Syntax*. Cambridge, Mass.: MIT Press.

Yuki Matsuda
 University of Washington
 Asian Languages and Literature
 Box. 353521
 Seattle, WA 98195-3521
 ymatsuda@u.washington.edu

Nominative Objects and Lack of Multiple Feature-checking in Child Japanese

Kazumi Matsuoka

Department of Foreign Languages and Literatures
University of Memphis

1. Checking of Multiple Nominative Case

The Japanese Nominative Object typically appears with [+stative] predicates. Some Japanese predicates, such as *wakaru* (to understand), *iru* (to need), *dekiru* (to be able to handle), *hoshii* (desirable), *suki* (be fond of), are inherently [+stative]. Only Nominative Objects are allowed to appear with those predicates.

- (1)a. Misato-ga doitsugo-ga deki-ru (koto)
Misato-NOM German-NOM able to handle-NPAST (fact)
'(The fact that) Misato can speak German.'
- b. *Misato-ga doitsugo-o deki-ru (koto)
Misato-NOM German-ACC able to handle-NPAST (fact)
'(The fact that) Misato can speak German.'

The [-stative] verbs can be converted into [+stative] by the potential verbal morpheme, *-(rar)e-*. When this happens, the object can appear either with the Nominative or the Accusative Case-particle.

- (2)a. Misato-ga doitsugo-ga hanas-e-ru (koto)
 Misato-NOM German-NOM speak-can-NPAST (fact)
 ‘(The fact that) Misato can speak German.’
- b. Misato-ga doitsugo-o hanas-e-ru (koto)
 Misato-NOM German-ACC speak-can-NPAST (fact)
 ‘(The fact that) Misato can speak German.’

In his extensive investigation of multiple feature-checking, Ura (1996) argued that ‘the Nominative Case-feature of T in Japanese and Korean may enter into multiple feature-checking relations...’ (1996: 336). He assumed that multiple feature-checking is subject to parameter-setting. Tense in Japanese and Korean, for example, has multiple sets of the Nominative Case-feature, while that is not the case in languages such as English. This implies that children need to process primary linguistic data to determine if their language allows multiple Case-checking. This process interacts with the default value of the parameter in the following fashion.

Suppose that UG contains a parameter for the availability of multiple Case-checking. The negative value of the parameter rules out (3b) and (3d) in the examples below.

- (3)a. John-ga chiizupan-o yak-e-ru (koto)
 John-NOM cheese bread-ACC bake-can-NPAST (fact)
 ‘(The fact that) John can bake cheese bread.’
- b. John-ga chiizupan-ga yak-e-ru (koto)
 John-NOM cheese bread-NOM bake-can-NPAST (fact)
 ‘(The fact that) John can bake cheese bread.’
- c. I want him (for the project).
- d. * I want he (for the project).

However, the (b) sentence is perfectly grammatical in adult Japanese, and hence Japanese children have opportunities to hear similar constructions as positive evidence. This positive evidence can guide the children as they re-set the value of the parameter. This learnability consideration leads to the prediction that the value of this parameter is set to be negative as a default.

On the other hand, if the default value of the parameter is set to be positive, the grammar would rule in all sentences in (3). In this situation, children who are acquiring English will face the dilemma of the absence of negative data. One possible source of the negative evidence is a direct correction from adult speakers. However, it is commonly observed that young children do not rely on

grammatical corrections from parents (Morgan and Travis 1989).

Assuming that the default setting of the parameter is negative, it is predicted that at an early age, Japanese young children would not produce the multiple Nominative construction, in which both the subject and the object appear with the Nominative Case-particle.

An empirical prediction from this assumption is that at some early point, children will not produce any multiple Nominative constructions, such as (4), early in the time course of language development:

- (4) Yuchan-ga omizu-ga hoshi-i.
 Yuchan-NOM water-NOM desirable-NPAST
 'Yuchan wants water.'

2. Method

The data were taken from three sets of databases, independently transcribed in the CHILDES format (MacWhinney and Snow 1990, Oshima-Takane and MacWhinney 1995): the AKI Corpus (Miyata 1995), the Noji Corpus (computerized for Morikawa 1997), and the KAN Corpus (currently in construction at the University of Connecticut). The age ranges of the children, during the time that their utterances were collected, are as follows:

- AKI: 1;5;7-3;0;0
- Sumihare (Noji): 1;11-3;3
- KAN: 2;2;3 – 3;0;12

The CLAN program was used to identify 2699 spontaneous utterances including the particle *ga*. Those sentences were sorted according to predicate types.

3. Results

The Nominative Case-particle *ga* is observed to appear early in the transcripts. Most of those early uses of *ga* are attached to the subject of intransitive verbs or non-stative transitive verbs, though. The stative predicates, with or without Case-particles, seem to appear a few months later than the first use of *ga*. The following table summarizes the age of the first appearance of *ga* and the stative predicate.

Table 1
The First appearance of the Nominative particle and stative predicates

	ga	Stative predicate	Nominative object
AKI	2;2;22	2;4:29	2;6;15
KAN	2;2;3+	2;3:14	2;4;25
Sumihare	1;11+	1;11+	2;3

(+ = the first file in the database)

The following is a summary of the number of stative predicates, with or without particles, and the number of multiple Nominative constructions.

Table 2
Multiple Nominative construction in child speech

	Stative predicates	Nominative Objects	Multiple Nominative (with the stative pred)
AKI	199	19	0
KAN	42	3	0
Sumihare	48	18	0

In any corpus, there were no multiple Nominative constructions with stative predicates.¹

When two arguments appear with a stative predicate in children's speech, only

¹ A few double Nominative constructions were observed with non-stative predicates. One utterance was observed in the AKI Corpus (age 2;9;14, *ana ga aiterunde ne, sennnaka ga*. 'There is a hole, on the back.), and another from the Noji Corpus (Age 3;2, *niichan-ga shita-ga akaku nattara toru n yo*. 'When the big brother gets a red tongue, you take it out.) This type of multiple Nominative construction occurs only when a certain semantic restriction is satisfied. (Kuno 1973: Chapter 3) We do not consider this type of multiple Nominative construction in this study.

one Nominative Case-particle was used, mostly on the object.²

- (5) Aki-chan are-ga hoshi-i yo. (AKI48, 2;10;7)
 AKI that-NOM want-NPAST
 'I (AKI) want that thing.'
- (6) Kore-ga deki-na-i. (KAN10-1, 2;4;25)
 this-NOM can-NEG-NPAST
 '(I) can't do this.'
- (7) hiru-wa omanju-ga tabe-ta-i. (Sumi27, 2;7)
 noon-TOP sweet bun-NOM eat-want-NPAST
 'I want to eat a sweet bun for lunch/afternoon snack.'

This observation indicates that the Nominative Case, on the subject and the object, is licensed by the Tense head, which carries only one set of formal features to check the Nominative Case.³

4. Conclusion

Young children seem to assume the negative value of the multiple Case-checking parameter at early stages of language acquisition. Children begin with the most conservative option, namely assuming that one head can check a certain formal feature only once. This is consistent with the following assumptions.

- Multiple feature-checking is subject to parametric variation. (Ura 1996)
- The default value of the parameter is negative.

Double Nominative constructions in adult speech, such as (8) below, can serve as positive evidence for re-setting the parameter:

² It is possible that children have a tendency to assign the Nominative Case-particle to an internal argument, whenever possible. More than 60% of early use of the Nominative particle *ga* was assigned to the internal argument of ergative verbs. Further research is needed to confirm this informal observation.

³ Note that a simple strategy, in which *ga* is mapped to logical subject is inconsistent with the children's willingness to use *ga* on objects of stative predicates. (W. Snyder, p.c.)

- (8) kotori-ga omizu-ga nomi-ta-i te (iw-te-ir-u).
 little bird-NOM water-NOM drink-want-NPAST COMP (say-teir-NPAST)
 'The little bird is saying that she wants to drink some water.'

Sentences such as (8) abound in adult speech.

References

- Chomsky, Noam. 1986. *Knowledge of Language: Its nature, origin, and use*. New York: Praeger.
- Chomsky, Noam. 1995. *The Minimalist Program*. Cambridge, MA: MIT Press.
- Koizumi, Masatoshi and Hiroyuki Ura. 1994. *Formal approaches to Japanese Linguistics 1: MIT Working papers in Linguistics Volume 24*. Cambridge, MA: MIT Working Papers in Linguistics.
- Kuno, Susumu. 1973. *The structure of the Japanese language*. Current Studies in Linguistics 3. Cambridge, MA: MIT Press.
- MacWhinney, Brian and Catherine Snow. 1990. 'The Child Language Data Exchange System: an update'. *Journal of Child Language* 17: 457-472.
- Matsuoka, Kazumi. 1998. The Acquisition of Japanese Case Particles and the Theory of Case Checking. Doctoral Dissertation, University of Connecticut, Storrs, CT. [distributed by MIT Working Papers in Linguistics: Cambridge, MA].
- Miyata, Susanne. 1995. 'The Aki corpus - longitudinal speech data of a Japanese boy aged 1.6-2.12'. *Bulletin of Aichi Syukutoku Junior College* No.34, 183-191.
- Morgan, James and Lisa Travis. 1989. Limits on negative information in language input. *Journal of Child Language* 16: 531-552.
- Morikawa, Hiromi. 1997. *Acquisition of case marking and argument structures in Japanese*. Tokyo: Kuroshio Shuppan.
- Noji, Junji. 1974-77. *Yojiki no gengoseikatsu no jittai: Volumes 1-4*. Hiroshima, Japan: Bunka Hyoron.
- Oshima-Takane, Yukiko and Brian MacWhinney, eds. 1995. *CHILDES manual for Japanese*. Montreal: McGill University.
- Ura, Hiroyuki. 1994. Varieties of raising and the feature-based bare phrase structure theory. MIT occasional papers in linguistics 7. Cambridge, MA: MIT Working Papers in Linguistics.
- Ura, Hiroyuki. 1996. Multiple feature-checking: A theory of grammatical function splitting. Doctoral dissertation, Massachusetts Institute of Technology, Cambridge, MA. [distributed by MIT Working Papers in Linguistics: Cambridge, MA].

Kazumi Matsuoka
 Foreign Languages and Literatures
 University of Memphis
 Campus Box 526430
 Memphis TN 38152-6430
 Email: kmatsuok@memphis.edu

On the Extent of Trace Deletion in ACD

Jason Merchant

University of California, Santa Cruz

This paper investigates the nature and syntactic placement of the restriction of quantificational determiners under the copy theory of movement and presents a brief argument from the interaction of antecedent-contained deletion (ACD) and Principle C that while relative clauses in ACD must be deleted from their base positions, complements and adjuncts in NP need not be, and hence must not be.⁷

1 Background

The paradigm in (1) has been discussed by Fiengo and May 1994 and Fox 1995. These authors note, following Chomsky 1981 among many others, that R-expressions in relative clauses on quantificational DPs trigger Principle C effects with respect to c-commanding pronouns, as in (1).¹

- (1) a. ??I introduced him₁ to every guy Peter₁ found attractive.
b. ??I sent her₂ every sweater Sheila₂ saw in the brochure.

This has traditionally been taken as an argument that LF-movement does not bleed Principle C of the binding theory (BT(C)), that is, that BT(C) must apply at S-structure. Chomsky 1995 however, who argues that the binding theory applies only at LF, reinterprets this fact to indicate that the restriction of the

⁷ I would like to thank Danny Fox and Jim McCloskey for helpful comments. The main argument presented here has been independently discovered by Uli Sauerland (see Sauerland forthcoming). This work was supported by a Fulbright grant to the author.

¹ The status of examples like (1) has been the source of some debate. The traditional discussion of bleeding of BT(C) by QR has been largely limited to cases where the c-commanding pronoun was in subject position, as in (i):

(i) * He_i liked every guy I introduced Peter_i to.

No-one disputes the ungrammaticality of examples like (i). The evidence is less clear with double object cases as in (1), however. Many speakers find the indicated coreference in examples similar to (1) perfectly grammatical; see Kennedy 1997:fn22 and Fox (to appear):fn 50 for discussion. The force of the argument in this squib goes through regardless of the status of such examples: everyone agrees that (at least) in ACD constructions, an apparent BT(C) violation is not found.

quantificational DP deletes from the moved constituent and remains in situ at LF, as in (2), motivating this selection by economy considerations: his 'Preference Principle'. In such a representation, the name will still be c-commanded by the pronoun, triggering a BT(C) violation at LF, after QR and deletion:

- (2) [every x: ~~x-guy-Peter_i-found-attractive~~] I introduced him_i to [x guy Peter_i found attractive]

However, as pointed out by Fox 1995, requiring that the restrictions of QRed constituents to remain in situ in all cases would be problematic for the account of ACD cases like (3).

- (3) I talked to every guy you did.

If the restriction is left in situ, the appropriate antecedent for resolving the ellipsis cannot be found, since the ellipsis site is still contained within its antecedent (the matrix) VP (the antecedent VP is enclosed in angled brackets, while the elliptical VP is in bold):

- (4) [every x] I <talked to [x guy you did **talk to x**]>

Fox therefore argues that in the case of ACD, the only converging derivation is the one in which the moved restriction remains, and the in situ one deletes, yielding (5).² In this representation, the antecedent-containment is eliminated, and the matrix and embedded VPs are identical, satisfying the licensing condition on ellipsis.

- (5) [every x: x guy you did **talk to x**] I <talked to x>

This modification of the application of the algorithm for deletion has an additional interesting consequence, as Fox points out. If the restriction must be eliminated from its base position for independent reasons, we predict that the BT(C) effect noted above for (1) should be obviated, since in these cases the R-expression will be interpreted at LF only in its higher position.

Indeed, this is exactly right. In cases such as (6), as noted by Fiengo and May 1994, the indicated coreference is possible, in contrast to (1).

- (6) I introduced him_i to every guy Peter_i wanted me to.

This sentence will have the representation in (7) as its only licit LF, with the in situ restriction eliminated to allow ellipsis resolution. In this structure, the

² This account assumes, as I will here, that QR is phrasal movement at LF: see Wilder 1997 for discussion with respect to ACD especially.

R-expression $Peter_i$ is no longer c-commanded by the pronoun him_i in the matrix clause.

- (7) [every x: x guy $Peter_i$ wanted me to **introduce him_i to x**]
I <introduced him_i to x>

Hence QR *can* bleed BT(C), if ACD is involved.

This bleeding effect does not hold for co-indexed pronominal subjects, however, as the data in (8) indicate:

- (8) a. * He_1 liked most (of the) guys I wanted $Peter_1$ to.
b. * She_2 read (us) every story $Beth_2$'s mom did.
c. * She_3 didn't give me a single book $Beth_3$ promised to.

These show that the grammaticality of (6) does not arise from BT(C) being 'turned off' in ACD or the like—rather, the contrast between (6) and (8) shows that the landing site for QR (in (8), of the object DP) must be in the c-command domain of the subject (either via a segment theory of m-command à la May 1985 if QR targets IP, or because QR here targets a position below the subject as in Fox 1995, Merchant 1998, and Johnson and Tomioka to appear). For reasons of simplicity, I will ignore this complication in what follows, and continue to represent the adjunction site of QR as above the subject, as in (7).

2 The extent of deletion in restrictions

The above discussion assumed that the deletion of the restriction of a moved quantificational DP was an all-or-nothing affair: the entire restriction either deletes or is retained. However, nothing forces this conclusion; in fact, as Fox (to appear) argues, we should expect deletion to be costly by the Economy metric, up to interpretability. Economy should in fact favor representations with minimal deletion in both positions, yielding (9b) for a simple case of quantification like (9a) (see Fox (to appear) for suggestions and references on how to interpret such LFs):

- (9) a. Abby read every book.
b. [every x: x book] Abby read [x book]

Since the restriction does not delete in the lower occurrence, the above explanation for Principle C effects at LF goes through under this modification, as the cases in (10) and their associated LFs in (11) show. (11a,b) demonstrate this for nominal arguments, and (11c,d) for adjuncts.

- (10) a. *I gave him_2 every evaluation of Bob_2 .
b. *I gave him_2 every report on Bob_2 (^{'s} division).

- c. *I reported her₃ to every cop in Abby₃'s neighborhood.
 - d. *I showed her₃ every picture from Abby₃'s mantelpiece.
- (11)
- a. [every x: x evaluation of Bob₂] I gave him₂ [x evaluation of Bob₂]
 - b. [every x: x report on Bob₂('s division)] I gave him₂ [x report on Bob₂('s division)]
 - c. [every x: x cop in Abby₃'s neighborhood] I reported her₃ to [x cop in Abby₃'s neighborhood]
 - d. [every x: x picture from Abby₃'s mantelpiece] I showed her₃ [x picture from Abby₃'s mantelpiece]

While this effect of minimizing deletions is harmless (if semantically redundant) in the general case, it is exactly in ACD structures that deletion must apply, non-economically, in order to satisfy Parallelism. Fox (to appear) notes that "the problem of ACD is solved only if the restrictor is eliminated from the base position" (p.19).

The assumption so far has been that when ACD requires deletion, the deletion is complete, yielding a simple variable as in (5) above. Combining this assumption with the ability of ACD to bleed BT(C), we expect that an R-expression which is embedded *anywhere* in the restriction of a quantificational DP in ACD structures will evade BT(C), since it will be deleted at LF. Surprisingly, however, this prediction is not borne out:

- (12)
- a. *I gave him₂ every report on Bob₂('s division) you did.
 - b. *I reported her₃ to every cop in Abby₃'s neighborhood you did.
 - c. *I showed her₃ every picture from Abby₃'s mantelpiece you did.

Ungrammaticality here is caused by the c-commanding pronoun, as can be seen in the following example, where the ungrammatical (13a) contrasts both with the grammatical (13b) lacking the c-commanding pronoun, and (13c), where the pronoun is not co-indexed with *Bob*:

- (13)
- a. *I gave him₂ back every report on Bob₂('s division) he₂ wanted me to.
 - b. I gave back every report on Bob₂('s division) he₂ wanted me to.
 - c. I gave him₃ back every report on Bob₂('s division) he₃ wanted me to.

If in such cases the entire restriction in the lower occurrence of the raised DP were to delete, we would derive the following representative LFs, given for the sentences in (12).

- (14)
- a. [every x: x report on Bob₂('s division) you did **give him₂ x**]
I <gave him₂ x >

- b. [every x: x cop in Abby₃'s neighborhood you did **report her₃ to x**]
 I <reported her₃ to x>
- c. [every x: x picture from Abby₃'s mantlepiece you did **show her₃ x**]
 I <showed her₃ x>

But in these LFs, the relevant R-expression no longer is c-commanded by the co-indexed pronoun. While this is the correct result for cases like (6) above, where ACD does bleed BT(C), it gives the wrong result for these cases.

The difference between (6), which is representative of the data examined in Fiengo and May 1994 and Fox 1995, (to appear), and the data in (12) is in the position of the R-expression which triggers the BT(C) violation. In the bleeding cases, the offending R-expression is in the relative clause which contains the VP ellipsis, while in the present cases, the R-expression is an argument or adjunct in the NP, but outside the relative clause. The fact that R-expressions in adjuncts pattern with those in arguments prevents any explanation of these facts which depends on the adjunct nature of the relative clause. Instead, I would like to suggest that the reason that such R-expressions continue to trigger Principle C violations, even in ACD, is that they belong to a part of the restriction which is not deleted.

In order to satisfy parallelism (in PF-deletion approaches to ellipsis resolution) or avoid regress (in LF-copying approaches), it is only necessary to delete that part of the structure which contains the ellipsis site—any further unmotivated deletion is in violation of economy considerations. The relevant LFs for (12), then, are not those in (14), but rather would seem to be those in (15). In these structures, the offending R-expression remains in situ, triggering the BT(C) violation.

- (15) a. [every x: x report on Bob₂('s division) you did **give him₂ x**]
 I <gave him₂ [x report on Bob₂('s division)] >
- b. [every x: x cop in Abby₃'s neighborhood you did **report her₃ to x**]
 I <reported her₃ to [x cop in Abby₃'s neighborhood] >
- c. [every x: x picture from Abby₃'s mantlepiece you did **show her₃ x**]
 I <showed her₃ [x picture from Abby₃'s mantlepiece]>

But surely such structures do not satisfy parallelism. After all, in (15), the bracketed antecedent VP is not the same as the elided VP in bold. The apparent problem comes from the implicit assumption that the relative operator can only bind a simple variable. But if we assume that QRed constituents can bind 'restricted' variables as in (9b), there is no reason for us not to expect this mechanism to extend to the binding of 'restricted' variables by relative operators

as well³. A simple ACD construction like (16a), then, will have the LF in (16b), where the restriction of the QRed DP has been only partially deleted.

- (16) a. I talked to every guy you did.
 b. [every x: x guy Op you did **talk to [x guy]**]
 I <talked to [x guy]>

In particular, only the relative clause must delete in the lower occurrence, since it is the relative clause which contains the ellipsis site. The remaining material in the NP (here the descriptive content *guy*) is subject to the same considerations of economy brought to bear above—since it need not delete to resolve the ellipsis, it may not. Whether the additional material is an argument or an adjunct is thus irrelevant—since these phrases do not contain the ellipsis, they may not delete.

Given this line of reasoning, one may wonder whether the entire relative clause itself need delete, that is, whether partial deletion (better obeying economy) internal to the relative clause may be possible. Perhaps, for example, the absolutely minimal amount of deletion would target only the regress-inducing VP, yielding (17):

- (17) [every x: x guy Op you did **talk to [x guy Op you did]**]
 I <talked to [x guy Op you did] >

This LF, however, suffers from the multiple defect that two of the three relative operators present have no variables to bind, 'restricted' or otherwise. We can thus conclude that when the relative clause contains the ellipsis site, the entire relative clause must delete to avoid regress.⁴

³ In fact, under the head-raising analysis of relative clauses resuscitated by Kayne 1994, the traces of relative operators would seem to be exactly what is proposed in the text for the ACD cases, where the relative operator's trace is supplied by the trace of a QRed constituent. However, it is unclear whether the head-raising analysis is correct (see Platzack 1997, Borsley 1997). Certainly the logic in the text with respect to BT(C) considerations cannot be extended generally to the traces of relative operators, since R-expressions in the external head of a relative clause (the bracketed material in (i)) do not trigger BT(C) violations:

- (i) a. I have a [report on Bob_i's division] that he_i won't like.
 b. I read every [report on Bob_i's division] he_i ever submitted.

If the trace of the relative operator contained a copy of the external head and was not deleted, the LF of the relative clause in (ia) would be that in (ii), and we would expect a BT(C) effect, contrary to fact.

- (ii) ... that he_i won't like [x report on Bob_i's division]

See Munn 1994 and Safir 1998 for discussion.

⁴ Though the discussion in the text establishes this conclusion only for cases where QR is needed to provide a variable for the relative operator to bind, the conclusion is completely general and extends to cases of ACD, discussed by Haik 1987 and Fiengo

Under this conception of licit deletion targets, the LFs for the examples in (12) will be like that in (18b), given for (12a), repeated here as (18a).

- (18) a. *I gave him₂ every report on Bob₂(’s division) you did.
 b. [every x: x report on Bob₂(’s division)
 Op you did **give him₂ [x report on Bob₂(’s division)]**]
 I <gave him₂ [x report on Bob₂(’s division)] >

In this structure, the offending R-expression *Bob₂* remains in situ, correctly triggering the BT(C) violation.

With this revision to the theory of deletion in mind, let’s re-examine the original cases examined by Fiengo and May and Fox, in which Principle C is bled by ACD-driven QR. The relevant example, repeated here in (19a), will have the LF in (19b) under the current proposal.

- (19) a. I introduced him₁ to every guy Peter₁ wanted me to.
 b. [every x: x guy Peter₁ wanted me to
introduce him₁ to [x guy]]
 I <introduced him₁ to [x guy]>

Here, Fox’s explanation remains unaltered, since what is left of the restriction in situ does not contain the R-expression.

One final case must be considered under the present proposal. One might wonder whether a BT(C) violation could arise at LF, due to the ellipsis resolution, if the relative clause contained a pronoun c-commanding the ellipsis site, and the restriction contained an R-expression coindexed to that pronoun. In such configurations, however, no Principle C effect arises:

- (20) I read every report on Bob₂’s division he₂ wanted me to.

This sentence should have the LF in (21), parallel to those seen above:

- (21) [every x: x report on Bob₂’s division he₂ wanted me to
read [x report on Bob₂’s division]]
 I <read [x report on Bob₂’s division]>

and May 1994, where the relative operator already is supplied with a variable, as in (i):

(i) I talked to every guy who wanted me to.
 Since argument structure may not change under ellipsis (see Chung et al. 1995 for extensive justification), every element in the ellipsis site will have to preserve the number and kind of arguments its overt counterpart exhibits, ruling out non-meaning preserving partial deletions like that in (ii):

- (ii) *[every x: x guy who wanted me to **talk to [x guy who wanted me]**]
 I <talked to [x guy who wanted me]>

While there is no BT(C) violation in the matrix, the fact that the relative clause is not elided in the higher occurrence of the raised quantifier means that the R-expression *Bob₂* is c-commanded by the subject of the relative clause. This apparent violation of BT(C) at LF is not unique to the proposal here, though. It forms part of a large body of evidence presented in Fiengo and May 1994 that indicates that R-expressions can be treated as pronominals under ellipsis. Fiengo and May dub the operation that performs this conversion *vehicle change*, and use it to account for facts like that in (22a) (p.275), which has the LF in (22b):

- (22) a. Mary introduced John₁ to everyone that he₁ wanted her to.
 b. [every x: x one that he₁ wanted her to
 introduce John₁ to [x one]
 Mary <introduced John₁ to [x one]>

This LF has the same defect seen above: the R-expression *John₁* comes to be c-commanded by a coindexed pronoun in the relative clause after ellipsis resolution. Application of vehicle change in both cases, however, turns these R-expressions into their pronominal correlates, yielding (23a,b):

- (23) a. [every x: x report on Bob₂'s division he₂ wanted me to
 read [x report on his₂ division]
 I <read [x report on Bob₂'s division]>
 b. [every x: x one that he₁ wanted her to
 introduce him₁ to [x one]
 Mary <introduced John₁ to [x one]>

The fact that there is no BT(C) violation under ellipsis in (20) is thus independent of the proposal made here. Vehicle change, which applies only in ellipsis, will not be able to ameliorate the violations found in the matrix clauses of examples like (12), however.

3 Conclusion

We have seen that a surprising asymmetry in sensitivity to Principle C in ACD configurations can be simply accounted for if the restrictions of QRed DPs in ACD are subject to the same considerations of economy that are assumed to hold for non-ACD QRed DPs: as much of the restriction must be left as is compatible with parallelism. In general, this will mean that the entire restriction is left in situ, except in ACD cases, where the relative clause must be deleted to prevent regress. The parts of quantificational DPs in ACD which do not contain the ellipsis site, however, do not delete, and trigger BT(C) effects exactly like their non-ACD counterparts.

References

- Borsley, Robert. 1997. "Relative clauses and the theory of phrase structure". *Linguistic Inquiry* 28: 629-647.
- Chomsky, Noam. 1981. *Lectures on government and binding*. Dordrecht: Foris.
- Chomsky, Noam. 1995. *The Minimalist Program*. Cambridge: MIT Press.
- Chung, Sandra, William Ladusaw, and James McCloskey. 1995. "Sluicing and logical form". *Natural Language Semantics* 3:239-282.
- Fiengo, Robert, and Robert May. 1994. *Indices and identity*. Cambridge: MIT Press.
- Fox, Danny. 1995. "Condition C effects in ACD". *MIT Working Papers in Linguistics* 27: 105-120.
- Fox, Danny. To appear. "Reconstruction, binding theory, and the interpretation of chains". *Linguistic Inquiry*.
- Haik, Isabelle. 1987. "Bound VPs that need to be". *Linguistics and Philosophy* 10: 502-530.
- Johnson, Kyle, and Satoshi Tomioka. To appear. "Lowering and mid-sized clauses". In *Proceedings of Tübingen Workshop on Reconstruction*.
- Kayne, Richard. 1994. *The antisymmetry of syntax*. Cambridge: MIT Press.
- Kennedy, Chris. 1997. "Antecedent-contained deletion and the syntax of quantification". *Linguistic Inquiry* 27: 662-688.
- May, Robert. 1985. *Logical Form*. Cambridge: MIT Press.
- Merchant, Jason. 1998. "Antecedent-contained deletion in negative polarity items". ms., UCL/OTS and University of California at Santa Cruz.
- Munn, Alan. 1994. "A minimalist account of reconstruction asymmetries". *Proceedings of the 24th Meeting of the Northeastern Linguistics Society*, pp. 397-410.
- Platzack, Christer. 1997. "A representational account of restrictive and nonrestrictive relatives: The case of Swedish". *Working papers in Scandinavian syntax* 59: 65-96.
- Safir, Ken. 1998. "Reconstruction and bound anaphora: Copy theory without deletion at LF". ms., Rutgers University.
- Sauerland, Uli. Forthcoming. *The meaning of chains*. PhD thesis, MIT.
- Wilder, Chris. 1997. "Phrasal movement in LF: *de re* readings, VP-ellipsis and binding". *Proceedings of the 27th Meeting of the Northeastern Linguistics Society*.

Jason Merchant
 Department of Linguistics
 University of California, Santa Cruz
 Santa Cruz, CA 95064
 merchant@ling.ucsc.edu

Linearization Properties of Romanian Clitics

Paola Monachesi

Utrecht University, Uil-OTS

1 Introduction

The Romanian clitic system comprises negation, auxiliaries, pronouns and intensifiers which can all appear before the verb:¹

- (1) Nu le-am mai văzut.
not cl.(acc) have again seen
'I haven't seen them again.'

Previous syntactic analysis of the Romanian verbal complex such as Rivero (1994) or Dobrovie-Sorin (1994) have accounted for the rigid order of the elements in (1) by postulating an appropriate grid of functional projections. Similarly, within a lexico-morphological approach such as that advocated by *template morphology* (Simpson & Withgott 1986), clitics would be assigned to different position slots, dealing in this way with the idiosyncratic properties of their linearization.

I will propose an alternative approach to the linearization of the Romanian verbal complex, cast within the HPSG (Pollard & Sag 1994) framework, which does not rely on the descriptive notion of template. It is based on the assumption that Romanian clitics do not constitute a uniform class. I will show that object pronouns and intensifiers like *mai* exhibit affixlike properties: they combine with the verb as result of lexical processes. On the other hand, auxiliaries such as *am* and negation *nu* share wordlike behavior: they are thus lexical items which combine with the verb in syntax. Under this view, the order of the elements in the verbal complex doesn't need to be stipulated, but it is the expected one given the different status of the clitics and the general architecture of the grammar.

The structure of the paper is as follows. Section 2 presents evidence in favor of the affixal status of Romanian pronominal clitics while an analysis of their properties is presented in section 3. Section 4 discusses Romanian auxiliaries and argues in favor of an analysis of clitic climbing in terms of *argument composition*. Section 5 deals with monosyllabic intensifiers. Motivations are provided in favor of their affixal status and a lexical treatment of their properties is proposed. Finally,

in section 6, an analysis of Romanian negation is presented. Section 7 contains some concluding remarks.

2 The affixal status of Romanian pronominal clitics

There is convincing evidence that Romanian pronominal clitics behave as affixes (cf. also Miller (1992) for French and Monachesi (1996), Monachesi (1999) for Italian). The arguments to support this position are mainly based on Zwicky (1977), Zwicky & Pullum (1983), Zwicky (1985) in which tests are proposed for distinguishing affixes from nonaffixes (or words from nonwords).

Romanian has only accusative and dative object clitics and they occur in the fixed order *dative-accusative*. The opposite order would be ungrammatical as can be seen in (2b):

- (2) a. Alexandru mi-l trimite astăzi.
 Alexandru cl.(dat) cl.(acc) sends today
 'Alexandru sends it to me today.'
- b. * Alexander îl-mi trimite astăzi.
 Alexander cl.(acc) cl.(dat) sends today

There is thus a clear similarity between clitics and affixes, which also exhibit rigid order.

Additional evidence against the word status of Romanian pronominal clitics comes from the fact that they do not have wide scope over coordination (3a), but they must be repeated in front of each conjunct (3b):

- (3) a. * El o dorea și căuta.
 he cl.(acc) desires and looks for
 'He desires her and looks for her.'
- b. El o dorea și o căuta.
 he cl.(acc) desires and cl.(acc) looks for
 'He desires her and looks for her.'

It should be noted that independent words can usually have wide scope over coordination.

Romanian pronominal clitics also present arbitrary gaps in their combinations, as in certain inflectional paradigms. Farkas & Kazazis (1980) mention that not all *dative-accusative* person and number combinations are grammatical in Romanian. In particular, it is not possible to have the first person accusative clitic *mă* together with a dative one:

- (4) a. **Ți m-au dat de nevastă numai pentru că*
 cl.(dat-2sg) cl.(acc-1sg) have given as wife only because
ai insistat.
 have insisted
 'They gave me in marriage to you only because you have insisted.'
- b. **Am auzit că părinți mei vor să i mă*
 have heard that parents mine want that cl.(dat-3sg) cl.(acc-1sg)
dea de nevastă.
 give as wife
 'I have heard that my parents want to give me in marriage to him.'

Similarly, a first person singular or plural clitic together with a second person plural one doesn't yield a grammatical result:

- (5) a. **Vor să mi vă omoare.*
 want that cl.(dat-1sg) cl.(acc-2pl) kill
 'They want to kill you on me.'
- b. **Vor să ni vă omoare.*
 want that cl.(dat-1pl) cl.(acc-2pl) kill
 'They want to kill you on us.'

However, the most convincing evidence in favor of affixal status for Romanian pronominal clitics comes from the fact that, under certain conditions, they can cooccur with full complements behaving virtually as agreement markers:

- (6) a. *Maria îi dă președintelui un buchet.*
 Maria cl.(dat) gives president-the a bouquet
 'Maria gives the president a bouquet.'
- b. *Ion m-a văzut pe mine.*
 Ion cl.(acc) has seen PE me
 'Ion saw me.'

In example (6a), the dative clitic *îi* cooccurs with the indirect object *președintelui*, while in (6b) the object clitic cooccurs with the direct object. In this case the doubled NP is usually preceded by the marker *pe*. It should be noticed, however, that a direct object or indirect object can also be expressed simply by means of a clitic:

- (7) a. Maria îi dă un buchet.
 Maria cl.(dat-3sg) gives a bouquet
 'Maria gives him a bouquet.'
- b. Ion m-a văzut.
 Ion cl.(acc-1sg) has seen
 'Ion saw me.'

It is usually assumed that the phonological shape of affixes can be affected by the phonology of the stem or of other affixes with which they combine. Romanian pronominal clitics behave, thus, as affixes since in specific contexts they can undergo certain changes.

Optional vowel deletion occurs if a clitic ending in *ă* precedes a verb beginning with unstressed *a* or *o*:

- (8) a. Mă așteaptă.
 cl.(acc) waits
 'He waits for me.'
- b. M-așteaptă.
 cl.(acc) waits

However, if the verb is an auxiliary, vowel deletion is obligatory:

- (9) a. M-a invitat.
 cl.(acc) has invited
 'He has invited me.'
- b. *Mă a invitat.
 cl.(acc) has invited

On the other hand, if the verb *a avea* 'to have' is present, vowel deletion is optional even when the forms of the verb are identical to those of the auxiliary:

- (10) a. M-ai acolo.
 cl.(acc) have there
 'You have me there.'
- b. Mă ai acolo.
 cl.(acc) have there

Optional vowel deletion occurs also in the case of the clitic *se* if it surfaces in front of a verb which begins with unstressed *a* or *o*:

- (11) a. Se așeză.
cl.(acc) sits
'He sits.'
- b. S-așeză.
cl.(acc) sits

However, there is no vowel deletion if the clitics *te*, *ne* or *le* occur in a similar context:

- (12) a. Te așteaptă.
cl.(acc) waits
'He waits for you.'
- b. *T-așteaptă.
cl.(acc) waits

These processes don't seem to be explainable in terms of productive phonological rules: different allomorphs should be postulated. I would like to suggest that, in Romanian, there are three classes of pronominal clitics: those that occur in front of any verbs (Class 1), those that occur before verbs that begin with *a* or *o* (Class 2) and those that occur as enclitics (Class 3):

- (13) Different classes of clitics

Person	1		2		3			4	5	6			3,6	
Case	D	A	D	A	D	A		DA	DA	D	A		D	A
					m.	f.					m.	f.	refl.	
Class 1	îmi	mă	îți	te	îi	il	o	ne	vă	le	îi	le	își	se
Class 2	mî-	m-	ți-	te-	i-	l-	o-	ne-	v-	le-	i-	le-	și-	s-
Class 3	-mi	-mă	-ți	-te	-i	-l	-o	-ne	-vă	-le	-i	-le	-și	-se

On the basis of the evidence presented in this section, I will thus conclude that Romanian pronominal clitics exhibit affix behavior. They will not be considered lexical items but featural information which is provided in the lexicon and used in morphology and phonology for the realization of the cliticized verb form.

3 The analysis of pronominal clitics

In the previous section, I have provided arguments in favor of the affixal status of Romanian pronominal clitics.

I will assume that cliticization of pronominal elements is a lexical operation which has both a syntactic/semantic effect and a morphophonological one (cf. also Monachesi (1996), Miller & Sag (1997)). The syntactic/semantic effect is reflected on the fact that pronominal clitics satisfy the subcategorization requirements of the verb they are an argument of, as the example below shows:

- (14) Le väd.
 cl.(acc) see
 'I see them.'

A lexical rule can be proposed to license cliticized verb forms:²

- (15) Complement Cliticization LR (CCLR)

$$\left[\begin{array}{ll} \text{word} & \\ \text{HEAD} & \text{verb} \\ \text{VAL | COMPS} & \boxed{1} \circ \boxed{2} \\ \text{CLTS} & \text{elist} \end{array} \right] \rightarrow \left[\begin{array}{ll} \text{VAL | COMPS} & \boxed{1} \\ \text{CLTS} & \boxed{2} \end{array} \right]$$

The rule will thus relate verbs with other ones with the same properties except that their subcategorization list is reduced.³ In other words, the effect of the rule is that the complements of the verb are removed from the COMPS list and are added as members of the CLTS list. The CLTS list contains thus the relevant information related to the clitics, which will be necessary for the spell out of the cliticized verb form. The crucial issue is then how to relate this information to the actual phonological realization of the pronominal clitic. I will propose that different constraints can be formulated to account for the realization of the cliticized verb form. In particular, the following one will account for the cliticized verb form in (14):

$$(16) \left[\begin{array}{l} \text{word} \\ \text{MORPH | STEM | SS | L | C | CLTS} \langle \text{NP}[\text{acc}]_{3\text{pl}} \rangle \end{array} \right] \rightarrow \left[\begin{array}{l} \text{AFFIX} \left[\begin{array}{l} \text{prefix} \\ \text{PHON} \langle \text{le} \rangle \end{array} \right] \end{array} \right]$$

The constraint says that if there is a host with a CLTS list with an element which is a third person, plural, feminine NP, there must be a pronominal clitic whose

phonological realization is *le*. It should be noticed that the only appropriate attribute for the type *affix* is PHON:

$$(17) \left[\begin{array}{l} \textit{affix} \\ \text{PHON } \textit{phon} \end{array} \right]$$

This implies that affixes (and pronominal clitics) are not signs: only phonological information is associated with them. This approach shares thus insights with realizational approaches to morphology such as those of Anderson (1992) or Stump (1992) that assume that morphemes do not exist as lexical entries, but only as realization of certain morphosyntactic properties of the host. However, in this case a feature is employed to spell out the phonological information and not a function. In this way, it is also possible to encode the prosodic properties of clitics and affixes.

Within this system, it is also possible to account for the combination of two pronominal clitics. The following is an example of the realization of the dative, first person plural clitic and the third person, accusative, masculine, plural clitic:

$$(18) \left[\begin{array}{l} \textit{word} \\ \text{MORPH} | \text{ST} | \text{SS} | \text{L} | \text{C} | \text{CLTS} \langle \text{NP}[\textit{dat}]_{1pl}, \text{NP}[\textit{acc}]_{3mpl} \rangle \end{array} \right] \rightarrow$$

$$\left[\text{AFFIX} \left[\begin{array}{l} \textit{affix} \\ \text{PHON} \langle \textit{ni-i} \rangle \end{array} \right] \right]$$

It can be shown that the combination of two clitics constitutes a new unit and doesn't result from the composition of two monosyllabic forms. In fact, the phonological changes that occur cannot be explained in terms of productive phonological rules.⁴

Within this system, certain generalizations can be expressed with respect to the direction of attachment of the pronominal clitics. It is possible to formulate a constraint like the following that accounts for the fact that proclitics must precede a finite verb:⁵

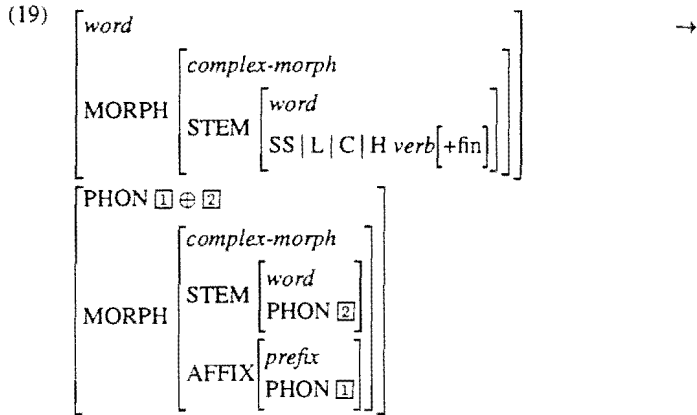

The constraint above requires that the phonology of the pronominal clitic (indicated by the tag $\boxed{1}$) must precede that of the host (indicated by the tag $\boxed{2}$), if this is a finite verb. The interaction of the lexical rule with the constraints presented above licenses a cliticized verb form like *le vād* 'I see them':

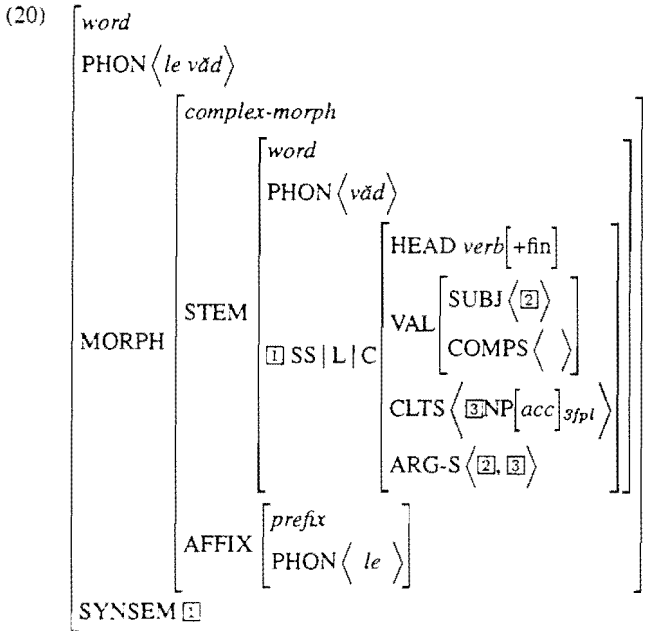

The description above states that *le vǎd* is a finite verb with an empty complement list and with the information about its direct object contained in the CLTS list. This is obtained as result of the lexical rule in (15), while the constraint in (16) is responsible for the spell out of this information as the clitic *le*. Since *vǎd* is a finite verb the clitic will precede the host, according to the constraint in (19).

4 The status of auxiliaries and clitic climbing

The lexical rule presented in the previous section can account for cases of cliticization with simple tenses. However, if an auxiliary verb is present, the pronominal clitic, which is an argument of the embedded verb, does not attach to the past participle, but must precede the auxiliary:

- (21) Le-am vǎzut.
cl.(acc) have seen
'I have seen them.'

Incidentally, it should be mentioned that in Romanian, auxiliaries can be found in the present perfect, conditional and future paradigms, as shown in the table below:

(22) Different forms of the Romanian auxiliaries

	1 Sg	2 Sg	3 Sg	1 Pl	2 Pl	3 Pl	
Aux Psp.	am	ai	a	am	ați	au	past participle
Aux Cond.	aș	ai	ar	am	ați	ar	bare infinitive
Aux Fut.	voi	vei	va	vom	veți	vor	bare infinitive

I will suggest that auxiliary verbs have word status in Romanian and that an analysis in terms of argument composition, as proposed for French (Abeillé & Godard 1994) and Italian (Monachesi 1993) can account for the clitic climbing cases illustrated in (21). Argument composition is a lexical mechanism according to which the auxiliary inherits the complements of the embedded verb, including those ones which might be realized as pronominal clitics. The auxiliary verb *am* will thus be described by the lexical entry below:

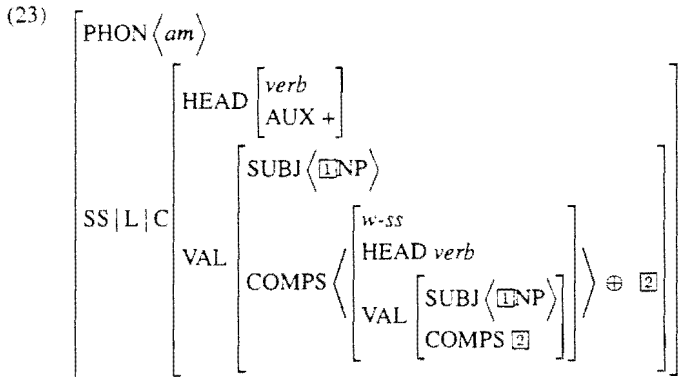

The auxiliary verb subcategorizes for the verbal complement and the complements of the latter. The operation of argument composition is illustrated by the structure sharing of the elements in the COMPS list, indicated by the tag 2. In this way, it is possible to account for the fact that pronominal clitics attach to the auxiliary verb. The auxiliary and the embedded verb act thus as a unit with respect to the placement of pronominal clitics.

The cliticized verb form *le am* which occurs in sentence (21) above, is thus obtained as result of the interaction of the Complement Cliticization Lexical Rule

and the constraints discussed in the previous section. The result is a description like the following:

(24)

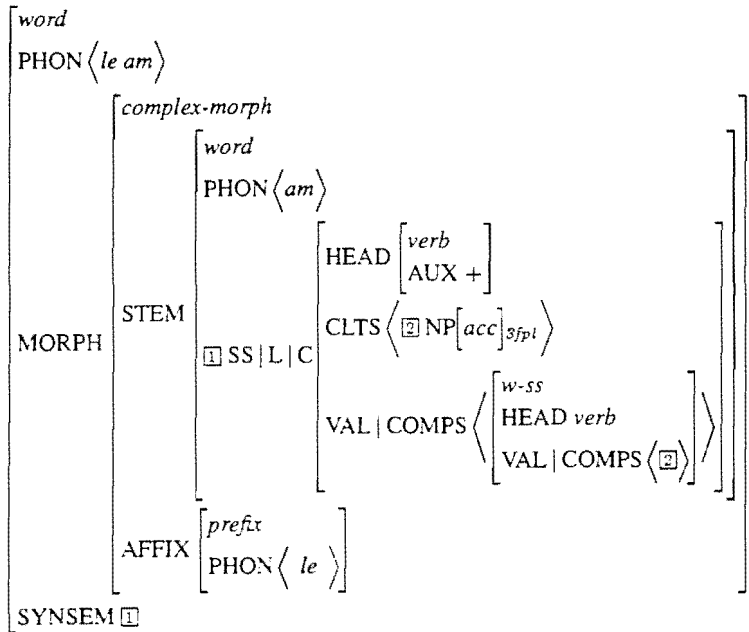

It states that the verb *am* is an auxiliary which subcategorizes for a verbal complement and the complement of the latter as result of the lexical mechanism of argument composition. The information about this argument is encoded in the CLTS list as result of the cliticization lexical rule and it is realized as the clitic *le*.

There is an exception to the generalization that object clitics must precede the auxiliary verb in Romanian. The third person feminine clitic *o* must attach to the past participle (25a) and cannot precede the auxiliary (25b):⁶

- (25) a. Am văzut-o.
 have seen cl.(acc)
 'I have seen her.'
- b. *O-am văzut.
 cl.(acc) have seen

The reason for the ill-formedness of these examples seems to be of phonological nature; the clitic *o* cannot precede an auxiliary which begins with a vowel. It should be noticed that in the case of the future paradigm, the auxiliary begins with a consonant (e.g. *voi*) and the clitic *o* can occur either after the infinitive (26a) or in front of the auxiliary (26b):⁷

- (26) a. *Voi vedea-o.*
 will see cl.(acc)
 ‘I will see her.’
 b. *O voi vedea.*
 cl.(acc) will see

Given the analysis for pronominal clitics presented in section 3, it is quite straightforward to account for these facts. The past participle is excluded as possible host in the constraints formulated for the realization of the pronominal clitics. The constraint in (16) should be thus revised in the following way:

$$(27) \left[\begin{array}{l} \text{complex-morph} \\ \text{STEM} | \text{SS} | \text{L} | \text{C} \left[\text{CLTS} \langle \text{NP}[\text{acc}]_{3\text{pl}} \rangle \right] \end{array} \right] \rightarrow \left[\begin{array}{l} \text{STEM} \left[\begin{array}{l} \text{word} \\ \text{SS} | \text{L} | \text{C} | \text{HEAD} \left[\text{VFORM} \left[\neg (\text{psp} \vee \text{bare-inf}) \right] \right] \end{array} \right] \\ \text{AFFIX} \left[\begin{array}{l} \text{prefix} \\ \text{PHON} \langle \text{le} \rangle \end{array} \right] \end{array} \right]$$

The additional condition says that the VFORM of the host must be different from past participle (or from bare infinitive). In this way it is possible to account for obligatory clitic climbing in the general case. This condition will not be present in the constraint which is responsible for the realization of the clitic *o*, allowing thus examples such as (25a) and (26a).

As already mentioned, the ill-formedness of the example in (25b) in which the clitic *o* has climbed should receive a phonological explanation. A phonological condition should be added in the constraint responsible for the spell out of the clitic *o*:

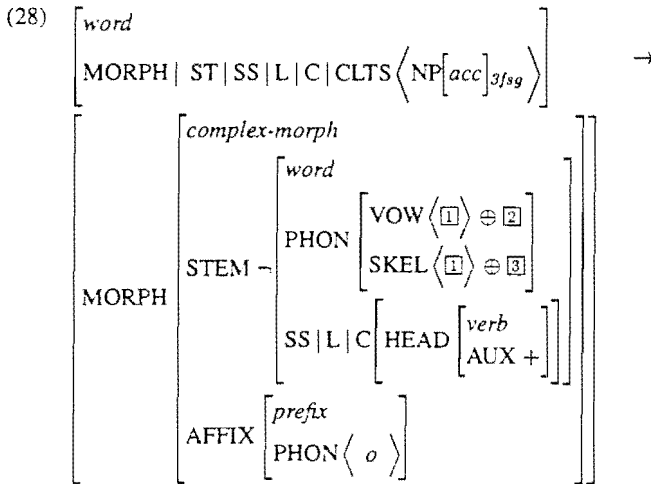

The constraint says that if there is a host with a CLTS list with an element which is a third person, singular, feminine NP, then it must be realized as the clitic *o* provided the host is not an auxiliary which begins with a vowel.

5 The analysis of monosyllabic intensifiers

In Romanian, the auxiliary can be separated from the non-finite verb by a small class of monosyllabic intensifiers, as shown in (1). They are: *mai*, 'again', *cam* 'little', *prea* 'very', *și* 'also', *tot* 'still'. A peculiar property of these elements, which distinguishes them from standard Romance adverbs, is that they can also intervene between a finite verb and pronominal clitics, arguing thus in favor of their affixal status:

- (29) Îl mai văd.
 cl.(acc) again see
 'I see him again.'

The example above shows that *mai* occurs between a pronominal clitic and the verb, suggesting that, like pronominal clitics, these intensifiers exhibit affix behavior.

It should be noticed that other types of adverbs cannot occur in these positions:

- (30) a. *Nu (î)l-am adesea văzut.
 not cl.(acc) have often seen
 'I have not seen him often.'
- b. *Nu (î)l-adesea văd.
 not cl.(acc) often see
 'I do not see him often.'

Additional evidence in support of the affixal status of these intensifiers is provided by the fact that they can also intervene between the negative element *ne* and the gerund:

- (31) Nemaiavind bani. Radu a plecat.
 not more having money, Radu has left
 'No longer having money, Radu left.'

The prefix *ne* is used to negate adjectives, participles and gerunds:

- (32) Sint nefericit.
 am unhappy
 'I am unhappy.'

The status of this element is rather uncontroversial, it is comparable to that of the English prefix *un-*.

Even though pronominal clitics and the intensifiers share affixal behavior, there is a crucial property that differentiates them. Unlike pronominal clitics, the intensifiers do not relate to an argument position, therefore they cannot be inherited by the auxiliary as result of argument composition. This implies that they cannot occur before an auxiliary, which is a desirable result given that a sentence like the following is not grammatical:

- (33) *Ion mai a scris profesorului.
 John again has written the teacher
 'John has written to the teacher again.'

Therefore, I will suggest that monosyllabic intensifiers attach to the verb by means of appropriate lexical rules:

(34) Intensifier Lexical Rule (ILR)

$$\left[\begin{array}{l} \textit{word} \\ \text{PHON } \textcircled{1} \\ \text{SS | L} \left[\begin{array}{l} \text{CAT} \left[\begin{array}{l} \text{HEAD } \textit{verb} \\ \text{CLTS } \textit{elist} \end{array} \right] \\ \text{CONT } \textcircled{2} \end{array} \right] \end{array} \right] \mapsto \left[\begin{array}{l} \text{PHON } \textit{mai} \oplus \textcircled{1} \\ \text{SS | L | CONT } \textit{mai} \textcircled{2} \end{array} \right]$$

The condition CLTS *elist* accounts for the fact that the intensifiers are closer to the verb than pronominal clitics.

6 The analysis of negation

Romanian distinguishes two ways to express negation, either by means of the affix *ne*, discussed in the previous section, or by the element *nu*. While *ne* is a prefix which is used to negate adjectives, participles and gerunds, *nu* is used to negate constituents. I will suggest that the latter has word status.

Evidence in favor of this hypothesis can be seen in the fact that *nu* can be stressed and can function as a host for pronominal clitics, acting thus as word:

- (35) Nu-l da.
 neg. cl.(dat) gives
 'He doesn't give it.'

Furthermore, it can be used in isolation, which is not the case for affixal elements:

- (36) Radu a venit dar Ion nu.
 Radu has come but Ion neg
 'Radu has come but Ion hasn't.'

Therefore *nu* will be considered a negative adverb which modifies a phrasal head:

- (37) $\left[\begin{array}{l} \text{PHON } \langle \textit{nu} \rangle \\ \text{SS | L} \left[\begin{array}{l} \text{CAT | HEAD } \left[\begin{array}{l} \textit{adv} \\ \text{MOD VP: } \textcircled{1} \end{array} \right] \\ \text{CONT } \left[\begin{array}{l} \textit{not-rel} \\ \text{ARG } \textcircled{1} \end{array} \right] \end{array} \right] \end{array} \right]$

Under the proposed analysis, it follows correctly that the position of negation will be that of the most external element in the verbal cluster, as shown in (1). This order follows as consequence of the word status of negation and of its subcategorization requirements.

7 Conclusions

I have argued for an approach to the linearization of the Romanian verbal complex which relies on a division of labor between the lexicon and syntax. In particular, I have shown that pronominal clitics and intensifiers have affixal status and combine with the host as result of a lexical process. On the other hand, auxiliaries and negation have word status and combine with the verb by means of syntactic processes. Alternatively, it could be possible to account for the rigid order of the clitics in (1) by relying on the traditional notion of position classes. Within HPSG, it is possible to formalize this concept by introducing an additional mechanisms such as that of *order domain formation* proposed in Reape (1994) and Kathol (1995) together with appropriate linear precedence (LP) statements. However, a disadvantage of such an approach is that it would merely describe the facts without offering any insight on why the order is the way it is. On the contrary, under the analysis presented here, the order of the clitics in the verbal complex is the expected one given the different status of the elements involved and the general architecture of the grammar.

Footnotes

¹I would like to thank the audience of the HPSG seminar in Tübingen, in particular Tilman Höhle and the audience of the EUROLAN summer school in Tusnad, especially Ana Maria Barbu and Emil Ionescu for comments and suggestions. Thanks also to Michael Moorigat for his comments on an earlier draft of this paper. Many thanks to all the people who helped me with the data: Ana Maria Barbu, Agnes Bende Farkas, Edward Goebbel, Emil Ionescu, Amalia Todiraşcu and Diana Zaiu. This work was partially supported by a grant from the *Netherlands Organization for Scientific Research* (NWO) while an NWO SIR-grant allowed me to attend the conference.

²I will assume a formalization of lexical rules as proposed in Meurers & Minnen (1997) which envisages them as descriptions relating *word* objects and not as meta-descriptions relating *lexical entries*. Note that the input and output descriptions will be connected via "→", while in the case of implicational constraints "⇒" will be used. In the rule, ○ is the shuffle operator defined in Reape (1994).

³The rule doesn't account for cases of clitic doubling exemplified in (6) which are outside the scope of this paper. However, it is possible to extend the analysis by adding to the subcategorization list of the verb, via lexical rule, only those complements that satisfy the semantic and pragmatic conditions of doubling. An additional requirement is that the pronominal clitic and the doubled complement should

share agreement and case information.

⁴Cf. Monachesi (1998) for a detailed discussion.

⁵A similar constraint should be formulated in the case of enclitics which occur after imperatives and gerunds.

⁶This is the case also for the conditional.

⁷Another environment where pronominal clitics precede a complex verb is in the presence of the modal verb *a putea* 'can'. In this case, the modal begins with a consonant and the pronominal clitic *o* must attach to it and not to the embedded verb.

References

- Abeillé, A. & D. Godard (1994): "The complementation of French auxiliaries." In: *Proceedings of the thirteenth West Coast Conference on Formal Linguistics*. CSLI publications, Stanford, pp. 157–173
- Anderson, S. (1992): *A-Morphous morphology*. Cambridge University Press, Cambridge
- Dobrovie-Sorin, C. (1994): *The syntax of Romanian. Comparative studies in Romance*. Mouton de Gruyter, Berlin
- Farkas, D. & K. Kazazis (1980): "Clitic pronouns and topicality in Rumanian." In: *Proceedings of the 16th regional meeting of the Chicago Linguistic Society*. Chicago, pp. 75–81
- Kathol, A. (1995): "Linearization-based German syntax." Ohio State University, PhD Thesis
- Meurers, D. & G. Minnen (1997): "Computational treatment of lexical rules in HPSG as covariation in lexical entries." *Computational Linguistics* 23.4:543–568
- Miller, P. (1992): *Clitics and constituents in Phrase Structure Grammar*. Garland, New York
- Miller, P. & I. Sag (1997): "French clitic movement without clitics or movement." *Natural Language and Linguistic Theory* 15.3:573–639
- Monachesi, P. (1993): "Object clitics and clitic climbing in Italian HPSG grammar." In: *Proceedings of the sixth conference of the European Chapter of the Association for Computational Linguistics*. Utrecht, pp. 437–442
- Monachesi, P. (1996): "A grammar of Italian clitics." Tilburg University, PhD Thesis
- Monachesi, P. (1998): "The morphosyntax of Romanian cliticization." In: P. Coppen, H. Van Halteren & L. Teunissen (eds.) *Proceedings of Computational Linguistics in The Netherlands 1997*. Rodopi, Amsterdam - Atlanta, pp. 99–118

- Monachesi, P. (1999): *A lexical approach to Italian cliticization*. CSLI publications and Cambridge University Press, Stanford
- Pollard, C. & I. Sag (1994): *Head-Driven Phrase Structure Grammar*. University of Chicago Press and CSLI publications, Stanford
- Reape, M. (1994): "Domain Union and word order variation in German." In: J. Nerbonne, K. Netter & C. Pollard (eds.) *German in Head-Driven Phrase Structure Grammar*. CSLI publications, Stanford, pp. 151–198
- Rivero, M. L. (1994): "Clause structure and V-movement in the languages of the Balkans." *Natural Language and Linguistic Theory* 12:63–120
- Simpson, J. & M. Withgott (1986): "Pronominal clitic clusters and templates." In: H. Borer (ed.) *The syntax of pronominal clitics. Syntax and Semantics. Vol. 19*. Academic Press, Orlando, pp. 149–174
- Stump, G. (1992): "On the theoretical status of position class restrictions on inflectional affixes." In: G. Booij & J. Van Marle (eds.) *Yearbook of Morphology*. Kluwer Academic Press, Dordrecht, pp. 211–241
- Zwicky, A. (1977): *On clitics*. IULC, Bloomington
- Zwicky, A. (1985): "Clitics and particles." *Language* 61.2:283–305
- Zwicky, A. & G. Pullum (1983): "Cliticization vs. inflection: English n't." *Language* 59.3:502–513

Paola Monachesi
 UiL-OTS
 Utrecht University
 Trans 10
 3512 JK Utrecht
 The Netherlands
 E-mail: Paola.Monachesi@let.uu.nl

Case Conversion in Japanese and the Nature of Move F*

Masao Ochi

University of Connecticut

1. Introduction

Since Harada (1971), *ga/no* conversion, the case conversion observed in a sentential modifier of a nominal, has been discussed extensively within the Japanese generative literature (Bedell (1972), Shibatani (1975), Nakai (1980), Saito (1983), Miyagawa (1993), and Watanabe (1996), to name a few).

- (1) a. John-*ga/no* kuru kanousei
John-Nom/Gen come probability
'the probability that John will come'
- b. John-*ga/no* t katta hon
John-Non/Gen bought book
'the book that John bought'

Recently, Miyagawa (1993) has offered an insightful analysis of this construction, arguing that the genitive subject raises into the spec of NP/DP in covert syntax. Departing from Miyagawa in some crucial respects, I suggest in this paper that the relevant movement takes place optionally in overt syntax. This claim is crucially based on Lasnik's (to appear) analysis of Exceptional Case Marking (ECM) constructions in English, according to which the ECM subject raises into a higher clause optionally in overt syntax. As will be shown below, the two constructions display a parallel distribution and hence should be given a unified account.

This paper is organized in the following way. In section 2, some important properties of English ECM constructions will be summarized. In particular, Lasnik's (to appear) optional overt raising analysis will be introduced, which will form the basis of subsequent discussions. Section 3 shifts our focus to *ga/no* conversion constructions. Miyagawa's (1993) analysis is summarized and critically examined. In section 4, an alternative hypothesis is proposed to accommodate data which pose a serious problem for Miyagawa's analysis. Concluding remarks are given in section 5.

2. Exceptional Case Marking and Optional Overt Raising

Exceptional Case Marking (ECM) constructions have received a great deal of attention within the generative literature. Recently, Lasnik and Saito (1991) have argued, based on Postal's (1974) analysis, that ECM subjects raise into the spec of AgroP in a higher clause. Their claim is based on examples such as (2)-(3), in which the ECM subject shows 'high binding' behavior. The data in (2), for instance, show that the ECM subject in (2a) behaves as if it is in the higher clause, licensing the reciprocal *each other* in this higher clause. This sharply contrasts with (2b) containing a nominative subject, which is degraded. Similarly, (3) illustrates that a bound pronoun within an adjunct clause in a higher clause is licensed by an ECM subject, but not by the nominative subject in an embedded clause.

- (2) a. The DA proved [two men to have been at the scene of the crime] during each other's trials.
 b. ?*The DA proved [that two men were at the scene of the crime] during each other's trials.
- (3) a. The DA proved [no suspect_i to have been at the scene of the crime] during his_i trial.
 b. ?*The DA proved [that no suspect_i was at the scene of the crime] during his_i trial.

Given this contrast, Lasnik and Saito (1991) (cf. also Postal 1974) argue that the ECM subject raises into the higher clause (i.e., the spec of AgroP) at some point in the derivation, which accounts for 'high binding' effects observed in the (a)-examples.

As for the "timing" of the raising, authors such as Bošković (1997a, b), Koizumi (1995) and Lasnik (1995) provide arguments that it occurs in overt syntax. For instance, Lasnik's (1995) argument is based on facts concerning *there*-constructions. If we follow Chomsky (1986) in assuming that there is covert movement of the associate to the position of *there*,¹ then paradigms such as the following indicate that covert movement does not affect scope/binding relations. Rather, such relations can be affected only by overt movement.

- (4) a. Many linguistic students aren't here. (many > not)
 b. There aren't many linguistic students here. (not > many)

Given this conclusion, the fact that movement of the ECM subject does affect scope/binding relations as in (2)-(3) indicates that the relevant movement takes place in overt syntax.

Note that it is in fact expected under the Move F hypothesis (cf. Chomsky (1995: chapter 4)) that covert movement does not affect scope and binding relations. Chomsky assumes that a lexical item consists of an array of features, including formal features, phonological features, and semantic features. According to Chomsky, only formal features are relevant for syntactic operations. For example, movement is triggered by the morphological need of a functional head to check off its own formal feature(s) by attracting the closest relevant formal feature(s) within its c-command domain. It is then natural to assume, in the spirit of minimalism, that only formal feature(s) are affected (or attracted) by movement. The fact that overt movement ‘pied-pipes’ the whole lexical item which contains the relevant formal feature(s) is attributed to properties of the phonological component. If, for instance, only formal features (FFs) of a lexical item LI are moved (attracted), then the FFs of LI and the rest of the category LI are not pronounceable: in Chomsky’s terms, “isolated features and other scattered parts of words may not be subject to [PF] rules, in which case the derivation is canceled” (Chomsky 1995: 262-263). One implication of this reasoning is that covert movement need not involve pied-piping, since LF does not feed into PF, by assumption. Rather, covert movement should affect only formal features of a lexical item LI, leaving the phonological and semantic features of LI intact. Assuming with Lasnik (1995), but contra Chomsky (1995), that features relevant for binding and scope are not part of formal features - an assumption which is certainly plausible on conceptual grounds - it follows that covert movement does not affect scope and binding relations. This line of reasoning correctly predicts the ‘in-situ’ behavior of the associate of *there* in (4b) with respect to scope.

Returning to ECM constructions, Lasnik (to appear) has provided arguments that movement of the ECM subject is in fact optionally overt. This claim is in part based on certain scope facts. Following Chomsky (1995),² Lasnik first argues that there are no reconstruction effects with A-movement.² For example, as noted by Zubizarreta (1982) among others, examples like (5a) are ambiguous with respect to the scope relation between a clausal negation and a universal quantifier in subject position. Yet, raising to subject constructions like (5b) do not show such scope ambiguity; in this case negation cannot take scope over *everyone*.

- (5) a. Everyone isn’t there yet.
 b. Everyone seems not to be there yet.

Lasnik points out that in a subclass of ECM cases in which the ECM subject is clearly raised into a higher clause (such as *make ... out* cases discussed by Kayne (1984)), the ECM subject does not fall within the scope of negation, which is consistent with the idea that there is no reconstruction with A-movement, assuming that ECM in this case involves overt raising of the embedded subject into a higher clause. This example is particularly telling, since the ECM

subject precedes the particle *out*, which is clearly an element of the higher clause.

- (6) The mathematician made every even number out not to be the sum of two primes.

(Lasnik, to appear)

Curiously however, in other ECM cases, where the raising is string vacuous, speakers find relevant examples ambiguous with respect to the scope relation between negation and the universal quantifier in subject position.³ Thus, there is a difference between cases like (6), which is unambiguous, and (7), which is ambiguous.

- (7) a. I believe everyone not to have arrived yet.
b. I proved every Mersenne number not to be prime.

(Lasnik, to appear)

Lasnik argues that this seemingly paradoxical situation is resolved if we assume that overt ECM raising is in principle optional. That is, the examples in (7) are structurally ambiguous; the ECM subject may or may not have raised overtly into the higher clause. On the other hand, in (6) the ECM subject is clearly raised into the higher clause in overt syntax. Hence the lack of the reading in which the universal quantifier is within the scope of negation is expected in (6) on a par with examples like (5b).

To summarize, Lasnik (to appear) claims that overt raising of ECM subjects is in fact optional.⁴ When it is clear from independent factors such as word order that the ECM subject is raised overtly, its movement affects scope possibilities.

Concerning the question of how to capture this optionality within the current theory, Lasnik suggests several possibilities, one of which is that *Agro* is optionally present in the structure. When it is present, it triggers overt raising of an accusative NP. When it is not, the nominal's Case is checked via covert raising of its formal features to the relevant verb.⁵

In the next section, I will argue that the *ga/no* conversion construction in Japanese parallels English ECM constructions in crucial respects. My discussion will be largely based on Miyagawa (1993).

3. Nom/Gen Case Conversion In Japanese

Nominative/genitive (or *ga/no*) conversion in Japanese is observed within the sentential modifier of nominals. In Japanese, the subject is normally marked with the nominative marker *-ga*.

- (8) a. John-ga/*no kita.
 John-Nom/*Gen came
 'John came.'
 b. John-ga/*no kita no?
 John-Nom/*Gen came Q
 'Did John come?'

On the other hand, as originally observed by Harada (1971), the subject in a clausal modifier of a nominal can optionally be marked with the genitive particle *-no*:

- (9) John-ga/no kuru kanousei
 John-Nom/Gen come probability
 'the probability that John will come'

Bedell (1972) and Saito (1983) among others offer an analysis of *ga/no* conversion, which is crucially based on the generalization that in Japanese, the XPs immediately dominated by a projection of a nominal bear *no*.

- (10) a. Taro*(-no) hon
 Taro-Gen book
 'Taro's book'
 b. Tokyo-kara*(-no) densha
 Tokyo-from-Gen train
 'a train from Tokyo'

The authors mentioned above attempt to assimilate *ga/no* conversion to the generalization in (10) by arguing that the subject of a sentential modifier of a nominal, when marked with *-no*, is in fact in a position immediately dominated by a projection of a nominal, such as the spec of NP.

- (11) [_{NP} John-no, [t, kuru] kanousei]
 John-Gen come probability

3.1. LF case checking: Miyagawa (1993)

Recently, Miyagawa has provided empirical arguments that 1) the genitive subject within the sentential complement clause of nominals raises out of its own clause, and 2) such movement takes place in covert syntax.

Miyagawa's first claim is based on scope interactions between nominative/genitive subject and the head noun. (12a), with a nominative subject, has only the reading in which the head noun *kanousei* 'probability' takes scope over the nominative subject *John-ka Mary* 'John or Mary.' However, (12b), with genitive subject, has the additional reading in which *John-ka Mary* 'John or Mary' takes scope over *kanousei* 'probability.'

- (12) a. [[[John-ka Mary]-ga kita] kanousei]-ga 50% izyoo da.
 John-or Mary-Nom came probability-Nom 50% over is
 i. 'The probability that John or Mary came is over 50%.'
 ii. '*The probability that John came or the probability that Mary came is over 50%.'
 probability > [John or Mary]; *[John or Mary] > probability
- b. [[[John-ka Mary]-no kita] kanousei]-ga 50% izyoo da.
 John-or Mary-Gen came probability-Nom 50% over is
 i. 'The probability that John or Mary came is over 50%.'
 ii. 'The probability that John came or the probability that Mary came is over 50%.'
 probability > [John or Mary]; [John or Mary] > probability

According to Miyagawa, the (12a) is unambiguous because a nominative subject does not raise out of the sentential complement clause. Hence, it is always within the scope of the head noun. Miyagawa suggests that (12b), with a genitive subject, allows scope ambiguity because a genitive subject raises into the spec of NP/DP at some point in the derivation. Intuitively speaking, therefore, this movement is the source of the additional reading in the latter example (I will discuss the exact nature of this movement shortly).

Miyagawa's second claim, that such movement takes place in covert syntax, is based on examples like (13a), in which other elements of the same sentential complement clause can occur to the left of a genitive subject (cf. Nakai (1980)).

- (13) a. [asita John-no kuru] kanousei
 tomorrow John-Gen come probability
 'the probability that John will come tomorrow'
- b. [John-no asita kuru] kanousei
 John-Gen tomorrow come probability

Modifiers such as *asita* 'tomorrow' must be accompanied by *no* when they occur within an immediate projection of a noun, as shown below.

- (14) a. asita-no kougī
 tomorrow-Gen lecture
 'tomorrow's lecture(s)'
- b. *asita kougī
 tomorrow lecture

The data in (14) suggest that *asita* 'tomorrow' in (13a), which lacks *-no*, is inside the complement clause. The conclusion to be drawn is that the genitive subject in (13a), which follows *asita* 'tomorrow,' must then also be within the

complement clause in overt syntax. On the basis of these considerations, Miyagawa concludes that genitive subject raises out of the sentential complement clause into the spec of NP/DP in covert syntax.

3.2. Questions

There are questions with the analysis of Miyagawa (1993), however. First, according to this analysis, covert movement (of the genitive subject) creates a new scope relation (cf. (12b)). Yet as Lasnik (1995) demonstrates, there is evidence to the contrary. As seen in Section 2, English expletive constructions demonstrate that covert movement (i.e. movement of formal feature(s)) is not sufficient to affect binding and scope relations. Thus, we would be led to say, given Miyagawa's analysis, that covert movement in Japanese, unlike in English, affects more than formal features. Once we accept this, however, a question arises as to why there is such a cross-linguistic variation with regard to the nature of covert movement.

Secondly, the specific proposals of Miyagawa (1993) regarding the nature of movement of the genitive subject raise further questions. In particular, certain empirical facts led to the addition of several complications to his analysis, which will be shown below to be untenable. Although not specifically enumerated in Miyagawa (1993), there are only three logical possibilities to consider with regard to the type of the movement of genitive phrases:

- (15) a. A-movement
 b. A-bar movement
 c. A or A-bar movement

Miyagawa (1993) argues for (15c). Let us consider why such a complication is needed. Given that A-movement in general shows no reconstruction effects (an assumption shared by Miyagawa as well), the hypothesis in (15a) must be discarded. Under such a hypothesis, the ambiguity of examples such as (12b) would not be expected. Rather, we would only expect the reading in which the genitive subject is outside the scope of the head noun, contrary to fact. How about (15b)? Given that A-bar movement is generally assumed to allow reconstruction (optionally), this option seems to be a good candidate for capturing the ambiguity of the relevant data. Yet Miyagawa does not adopt this hypothesis, apparently for empirical reasons. Miyagawa reports that in cases where genitive subject is preceded by another element of the same sentential complement clause, the example is no longer ambiguous.⁶ The crucial (16b) is taken from Miyagawa (1993: 233).

- (16) a. [[John-ka Mary]-no disuko-de odotta] riyuu-o osiete.
 John-or Mary-Gen disco-at danced reason-Acc tell me
 i. 'Tell me the reason why John or Mary danced at the disco.'
 ii. 'Tell me the reason why John danced at the disco or the reason why Mary danced at the disco.'
 reason > [John or Mary]; [John or Mary] > reason
- b. [[disuko-de [John-ka Mary]-no odotta] riyuu]-o osiete.
 disco-at John-or Mary-Gen danced reason-Acc tell me
 i. 'Tell me the reason why John or Mary danced at the disco.'
 ii. '*Tell me the reason why John danced at the disco or the reason why Mary danced at the disco.'
 reason > [John or Mary]; *[John or Mary] > reason

This lack of ambiguity in (16b) is puzzling under the hypothesis in (15b); it is not clear why the presence of elements such as the PP *disuko-de* 'at disco' preceding the genitive subject would block reconstruction. This fact appears to have led Miyagawa (1993) to adopt the hypothesis in (15c). Specifically, he proposes the following.

- (17) Spec of DP may be A- or A'-position. (Miyagawa 1993: 227)
 (18) a. A-movement allows no reconstruction.
 b. A'-movement allows reconstruction.

Miyagawa argues that the ambiguity of (16a) is due to the nature of the specifier position of NP/DP in Japanese; it is ambiguous between an A and A-bar position. When it is an A-position, we only obtain the reading in which the genitive subject is outside the scope of the head noun, since, by assumption, there is no reconstruction with A-movement. The other reading, in which the genitive subject is within the scope of the head noun, obtains when the spec of NP/DP is an A-bar position; A-bar movement allows reconstruction.⁷ Given all these considerations, Miyagawa claims that in examples such as (16b), the presence of a PP between the genitive subject and the spec of NP/DP blocks A-movement of the genitive subject.

... even a PP occurring to the left of the genitive quantifier blocks the quantifier from taking wide scope over the head noun 'reason,' indicating failure of A-movement to occur (Miyagawa 1993: 232).

Rather, only A-bar movement of the genitive subject is allowed in (16b). Hence, only the reading in which the genitive subject is within the scope of the head noun is possible in this example.

However, this part of Miyagawa's analysis is questionable for several reasons. First, it is not obvious why adjunct PPs, which need no Case, would block A-movement of the genitive subject. Second, suppose for the sake of discussion

that Miyagawa were in fact right in claiming that only A-bar movement of the genitive phrase is possible in such examples. However, this A-bar movement would still have a curious property, namely, that its (scope) reconstruction is obligatory. If reconstruction of A-bar movement with a genitive subject were optional, then we would expect data such as (16b) to be ambiguous, contrary to fact. Hence, it is crucial for Miyagawa that this particular instance of A-bar movement is obligatorily reconstructed. However, there are data showing that this obligatory scope reconstruction is not a property of A-bar movement in general. For example, as noted by Liu (1990), downward monotonic quantifiers in object position do not take scope over the subject, as shown in (19a). Yet as pointed out by Szabolsci and Zwarts (1993), the object *few books* can take scope over the subject once it is preposed (Negative Preposing), as shown in (19b).⁸

- (19) a. Every man read few books.
 every > few, *few > every
 b. Few books did every man read.
 every > few, few > every

The ambiguity of (19b) suggests that scope reconstruction with A-bar movement in general is not obligatory. If so, Miyagawa's account of (16b) does not go through. In the next section, I will propose an alternative way to interpret the data, which dispenses with the complications of Miyagawa's analysis.

4. Optional Overt Movement of Genitive Phrase in Japanese

I suggest that the whole range of data discussed so far points to the following conclusion.

- (20) a. Genitive phrase raises into the spec of NP/DP optionally in overt syntax (via A-movement).
 b. The reading in which the genitive subject is outside the scope of the head noun obtains only when the genitive subject has raised into the spec of NP/DP in overt syntax.

Adopting Lasnik's (to appear) idea about the optionally overt movement in ECM constructions in English, I suggest that the D head (or whatever functional head which mediates the checking of genitive Case) in Japanese is optionally present in the structure.⁹ If present, this head triggers overt movement of genitive subject. If not, its genitive Case is checked off by the movement of the formal features of the genitive subject to the position of the head N (*kanousei* 'probability' etc.).

Note that I will not assume a dual status for the spec of NP/DP in Japanese, contrary to Miyagawa. Rather, the relevant movement is unequivocally identified as an A-movement, which allows no scope reconstruction (cf.

Chomsky (1995) and Lasnik (to appear)). (20b) is due to the fact that only overt movement affects scope/binding relations (cf. discussion in Section 2): covert (feature) movement of a genitive subject does not create a new scope relation.

According to the present proposal, examples such as (16b) are unambiguous because the genitive subject has not raised out of the sentential complement clause in overt syntax, a fact which is clear from the word order. I assume that the genitive subject (or its formal features) in such examples undergoes movement in covert syntax for genitive Case licensing, but this covert movement does not affect scope/binding relations. In contrast, examples such as (16a) do show a scope ambiguity because they are structurally ambiguous; genitive phrase may or may not have raised out of the sentential complement clause in overt syntax. The availability of the reading in which the genitive subject takes scope over the head noun in (16a), but not in (16b), is due to the fact that only in the former is the structure available in which the genitive phrase has raised into the spec of NP/DP in overt syntax.

Thus, under the current proposal, there is no difference between Japanese and English with respect to the nature of covert movement. In both languages (and quite possibly, universally), covert movement (i.e. movement of formal feature(s)) does not affect scope (and binding) relations.

Note also that the behavior of the genitive subject in Japanese parallels that of English ECM subjects; its overt movement is in principle optional, and when the word order clearly shows that overt movement has/has not occurred, scope interpretations come out as expected. The two constructions considered are the mirror image of each other in the sense that in English ECM constructions, word order evidence shows that overt A-movement has taken place (i.e. *make ... out* constructions) whereas in the case of genitive subject in Japanese, the same type of evidence indicates that the genitive subject has not raised in overt syntax (i.e. locative PPs etc. preceding the genitive subject).¹⁰

4.1. Lack of reconstruction effects with genitive subjects

In the previous subsection, I argued that the genitive subject raises into the spec of NP/DP optionally in overt syntax. Recall also that we pursued the parallelism between this construction and English ECM constructions. Let us consider more data from Japanese, in which an additional modifier of the head noun is present, preceding the sentential complement clause (of the head noun) containing the genitive subject.

- (21) Relative clause + complement clause + N
- a. [kono compyuutaa-ga keisan-shita] [[Nomo-ka Irabu]-ga
 this computer-Nom calculated Nomo-or Irabu-Nom
 kotoshi 20 shoo-suru] kanousei
 this year 20 win probability
 ‘the probability [that Nomo or Irabu will win 20 games this
 year] [which this computer calculated]’
 ‘*[[the probability that Nomo will win 20 games this year] or
 [the probability that Irabu will win 20 games this year]]
 [which this computer calculated]’
 probability > Nomo or Irabu; *Nomo or Irabu > probability
- b. [kono compyuutaa-ga keisan-shita] [[Nomo-ka Irabu]-no
 this computer-Nom calculated Nomo or Irabu-Gen
 kotoshi 20 shoo-suru] kanousei
 this year 20 win probability
 ‘the probability [that Nomo or Irabu will win 20 games this
 year] [which this computer calculated]’
 ‘(?)[[the probability that Nomo will win 20 games this year]
 or [the probability that Irabu will win 20 games this year]]
 [which this computer calculated]’
 probability > Nomo or Irabu; (?)Nomo or Irabu > probability

The fact that (21a) is unambiguous is not surprising. The subject NP of the sentential complement clause bears nominative Case, so there is no reason for us to expect it to raise out of the sentential complement clause. (21b) has a genitive subject. For many speakers, this example is ambiguous, although the reading in which *Nomo-ka Irabu* ‘Nomo or Irabu’ takes scope over the head noun *kanousei* ‘probability’ is slightly more difficult to obtain than in the example without the preceding relative clause. This shows that the presence of another modifier preceding the sentential complement clause (and the genitive subject) does not force the genitive subject to be within the complement clause in overt syntax. Rather, (21b) is structurally ambiguous with respect to the position occupied by the genitive subject. We assume that the relative clause in this language (at least) has the option of appearing in a position higher than the landing site of the genitive phrase (i.e. the spec of NP/DP).

Now we examine examples minimally different from (21) in that the subject of the sentential complement clause precedes the relative clause. Only (22b) with genitive subject is grammatical. Furthermore, this example is unambiguous.

- (22) Nom/gen phrase + rel. clause + (subjectless) complement clause + N
- a. *[[Nomo-ka Irabu]-ga, [kono compyuutaa-ga keisan-shita],
 Nomo-or Irabu-Nom this computer-Nom calculated
 kotoshi 20 shoo-suru] kanousei
 this year 20 win probability
 'the probability [that Nomo or Irabu will win 20 games this
 year] [which this computer calculated]'
- b. [[Nomo-ka Irabu]-no, [kono compyuutaa-ga keisan-shita],
 Nomo-or Irabu-Gen this computer-Nom calculated
 kotoshi 20 shoo-suru] kanousei
 this year 20 win probability
 '?*the probability [that Nomo or Irabu will win 20 games this
 year] [which this computer calculated]'
 '[[the probability that Nomo will win 20 games this year] or
 [the probability that Irabu will win 20 games this year]]
 [which this computer calculated]'
 '?*probability > Nomo or Irabu; Nomo or Irabu > probability

Some speakers find (22b) rather awkward, but the contrast between (22a) and (22b) is clear. A pause (right) before and after the intervening relative clause (*kono compyuutaa-ga keisan-shita* 'this computer calculated') dramatically improves the status of (b), but not (a), which is unsalvageable. Now interestingly, the speakers I consulted find the reading in which *Nomo-ka Irabu-no* 'Nomo or Irabu-Gen' is within the scope of *kanousei* 'probability' rather difficult to obtain in (22b). This difficulty is in fact what is expected under our analysis, which claims that movement of genitive subject is optionally overt. In (22b), we can indeed see that the genitive subject has raised into spec of NP/DP in overt syntax, which accounts for the availability of the reading in which *Nomo-ka Irabu-no* 'Nomo or Irabu-Gen' is outside the scope of *kanousei* 'probability.'

- (23) [Genitive NP_i [_{relative clause}] [t_i] probability]
- ↑ _____ ↓

The lack of the other reading (i.e. Nomo or Irabu < probability) also follows if we assume, following Chomsky (1995) and Lasnik (to appear), that there is no (scope) reconstruction with A-movement. This example is thus analogous to (6), repeated below, in which the universal quantifier necessarily takes scope over negation.

- (24) The mathematician made every even number out not to be the sum of two primes.

Note that the data above have clear theoretical implications. First, we must conclude that the movement of a genitive subject is unequivocally A-movement.

If it were an instance of A-bar movement, examples like (22b) would be expected to be ambiguous, due to an (optional) scope reconstruction. In addition, the fact that the majority of speakers find (21b) ambiguous and (22b) unambiguous indicates that relative clauses in Japanese do not have a unique adjunction site (assuming that the genitive subject is raised into a unique spec position for its Case licensing): the ambiguity of (21b) suggests that the relative clause can (optionally) be attached to a position higher than the genitive subject in the spec of NP/DP, while the fact that the relative clause can be preceded by the (raised) genitive subject as in (22b) shows that the relative clause can also (optionally) be below the landing site of the genitive phrase.

5. Conclusion

In this paper, I argued that the genitive subject in Japanese raises into its Case licensing position optionally in overt syntax, departing from Miyagawa's (1993) claim that the relevant movement takes place in covert syntax. The proposed analysis is crucially based on Lasnik's (to appear) analysis of ECM constructions in English. As was seen, the two constructions show a striking parallelism and hence should be given a unified account. The optionality in each case consists in the optionality of a node - AGRO in English and D in Japanese - which, if present, triggers obligatory overt movement. One consequence of the proposed analysis is that covert (feature) movement does not affect scope/binding relations cross-linguistically. As discussed in Section 2, such a characteristic is a natural consequence of the Move F hypothesis.

NOTES

* For helpful comments, I thank Željko Bošković, Kazuki Kuwabara, Howard Lasnik, Hideki Maki, Kazumi Matsuoka, Shigeru Miyagawa, Masatake Muraki, and Miyoko Yasui. I am also grateful to Rosanne Pelletier for proofreading the entire manuscript.

¹ One motivation for this hypothesis is the agreement pattern shown by *there*-constructions. Apparently, the verb agrees with the post-copular NP in a non-subject position. This is accounted for if we assume that the post-copular NP raises to the position occupied by *there* at some point in the derivation.

- | | | |
|------|----|------------------------------------|
| (i) | a. | There is/*are a man in the garden. |
| | b. | There are/*is men in the garden. |
| (ii) | a. | A man is/*are in the garden |
| | b. | Men are/*is in the garden. |

² This is also assumed by Miyagawa (1993), which will be discussed in the next section.

³ Hornstein (1995: 239) is an exception in this regard. See Lasnik (to appear) for more discussion of this issue.

⁴The only paradigm in Lasnik and Saito (1991) (cf. Postal (1974)) which argues for obligatory raising of the ECM subject involves Binding Condition C. (i) shows that the ECM subject is obligatorily raised into a higher clause. Otherwise, we would not expect the example to be in violation of Condition C.

- (i) *John_i believes him_i to be a genius even more fervently than Bob_i does.
- (ii) John believes he_i is a genius even more fervently than Bob_i does.

Lasnik argues that pronouns are obligatorily shifted in overt syntax, citing other cases of object shift in Germanic languages, where pronouns as opposed to lexical NPs shift obligatorily. See Lasnik (to appear) for more discussion and some evidence from English for this conclusion.

⁵An alternative approach to this optionality is to say that Agro can be inserted into the structure overtly or covertly. If it is inserted overtly, it triggers overt raising. If inserted covertly, it triggers covert raising, which should affect only formal features, given Chomsky's (1995) Move F hypothesis.

⁶Miyagawa claims that relevant examples are ambiguous in some dialects when the preceding element is a bare adverb like *kinoo* 'yesterday'.

- (i) a. Gen subject + (bare) adverb
[[John-ka Mary]-no kinoo kita] kanousei
John-or Mary-Gen yesterday came probability
i. 'The probability that John or Mary came'
ii. 'The probability that John came or the probability that Mary came'
- b. (bare) adverb + Gen subject
[kinoo [John-ka Mary]-no kita] kanousei
yesterday John-or Mary-Gen came probability
i. 'The probability that John or Mary came'
ii. 'The probability that John came or the probability that Mary came'

Miyagawa judges (ib) to be ambiguous, yet reports that there is a dialectal variation: "... with the sentential adverbs placed to the left, some speakers find the wide-scope reading of the genitive subject less preferred; in a few instances, this reading was judged as very difficult to get (Miyagawa 1993: fn. 3)." I also find the reading in question hard to obtain. Most speakers I have interviewed also find the example unambiguous. At any rate, it should be noted that even in the dialect with which Miyagawa is concerned, this behavior of bare adverbs is exceptional. As discussed in the text, other elements preceding the genitive subject systematically exclude the reading in which the genitive subject is outside the scope of the head noun.

⁷It should be noted that although A-bar reconstruction should in principle be optional, it is in fact crucial for Miyagawa that scope reconstruction with A-bar movement indeed be obligatory. This point will be discussed below.

⁸That this type of preposing is an instance of A-bar movement is demonstrated by the fact that it exhibits a Weak Cross Over effect (cf. Koizumi 1995: 143 fn., 3), as (i) shows.

- (i) *No book_i would I expect its_i author to praise t_i publicly.

⁹ See footnote 5 for an alternative line of approach to the optionally overt A-movement.

¹⁰ In the next section, we will consider Japanese examples in which the word order clearly shows that the genitive subject is raised in overt syntax.

References

- Bedell, George. 1972. "On *no*," *UCLA Papers in Syntax 3: Studies in East Asian Syntax*. 1-20.
- Bošković, Željko. 1997a. "Coordination, Object Shift, and V-movement." *Linguistic Inquiry* 28, 357-365.
- Bošković, Željko. 1997b. *The Syntax of Non-Finite Complementation: An Economy Approach*. Cambridge, Massachusetts: MIT Press.
- Chomsky, Noam. 1986. *Knowledge of Language*. New York: Praeger.
- Chomsky, Noam. 1995. *The Minimalist Program*. Cambridge, Massachusetts: MIT Press.
- Harada, Shin-Ichi. 1971. "Ga-No Conversion and Ideolectal Variations in Japanese." *Gengo kenkyuu* 60: 25-38.
- Hornstein, Norbert. 1995. *Logical Form: From GB to Minimalism*. Cambridge, Massachusetts and Oxford: Blackwell Publishers.
- Kayne, Richard. 1984. "Principles of particle constructions," in Jacquelinen Guéron et. al. (eds.), *Grammatical Representation*. Dordrecht: Foris.
- Koizumi, Masatoshi. 1995. *Phrase Structure in Minimalist Syntax*. Ph.D. dissertation. MIT.
- Lasnik, Howard. 1995. "Last Resort and Attract F." in L. Gabriele, D. Hardison and R. Westmoreland (eds.), *Proceedings of the Sixth Annual Meetings of the Formal Linguistics Society of Mid-America*. Indiana University.
- Lasnik, Howard. to appear. "Chains of Arguments," in Samuel David Epstein and Norbert Hornstein (eds.), *Working Minimalism*. Cambridge, Massachusetts: MIT Press.
- Lasnik, Howard and Mamoru Saito. 1991. "On the subject of infinitives," in *CLS 27, Part 1: The General Session*. Chicago Linguistic Society.
- Liu, Feng-hsi. 1991. *Scope Dependency in English and Chinese*. University of California. Los Angeles dissertation.
- Miyagawa, Shigeru. 1993. "Case-checking and Minimal Link Condition," in Collin Phillips (ed.), *MIT Working Papers in Linguistics* 19. 213-254. MITWPL.
- Nakai, Satoru. 1980. "A Reconsideration of Ga-no Conversion in Japanese," *Papers in Linguistics* 13: 279-320.
- Postal, Paul. 1974. *On Raising: One Rule of English Grammar and Its Implications*. Cambridge, Massachusetts: MIT Press.
- Saito, Mamoru. 1983. "Case and Government in Japanese," in *Proceedings of the Second West Coast Conference on Formal Linguistics*, 247-259, CSLI, Stanford.

- Shibatani, Masayoshi. 1975. "Perceptual Strategies and the Phenomena of Particle Conversion in Japanese." in *Papers from the Parasession on Functionalism*. Chicago Linguistic Circle.
- Szabolcsi, Anna and Frans Zwarts. 1997. "Weak Islands and An Algebraic Semantics for Scope Taking." in Anna Szabolcsi (ed.). *Ways of Scope Taking*. 217-262, Dordrecht: Kluwer Academic Publishers.
- Watanabe, Akira. 1996. "Nominative-Genitive Conversion and Agreement in Japanese: A Cross-Linguistic Perspective," *Journal of East Asian Linguistics* 5: 373-410.
- Zubizarreta, Maria Luisa. 1982. *On the Relationship of the Lexicon to Syntax*. Ph.D. dissertation. MIT.

Masao Ochi
University of Connecticut
Department of Linguistics
Storrs, CT 06269-1145 USA
mao94001@uconnvm.uconn.edu

Thetic /Categorical Judgment and Relative Clauses in Korean

Hyeson Park

University of Arizona

1. Introduction

Korean has internally headed relative clauses (henceforth IHRC) as well as externally headed relative clauses (henceforth EHRC). The EHRC and the IHRC in Korean are illustrated in (1) and (2), respectively¹:

1. John-i [e_i pang-eyse nao-n] totwuk₁-ul chap-ass-ta.
John-nom room-from come out thief -acc catch-past-decl
2. John-i [totwuk-i pang-eyse nao-n] kes] -ul chap-ass-ta.
John-nom thief -nom room-from come out comp-acc catch-past-decl.
' John caught a thief who was coming out of a room.'

In (1) the semantic head noun of the relative clause, *totwuk* 'a thief', is located external to the embedded clause, and the gap which is coindexed with the head is in the embedded clause². On the other hand, in (2) the semantic head noun *totwuk* 'a thief' occurs within the embedded clause.

It has been argued that in many languages the head of an IHRC undergoes either overt or covert movement, and a structure similar to or the same as an EHRC is derived (Cole, 1987; Williamson, 1987; Barss et al., 1990; Basilico, 1996). In this paper, I examine the structure of Korean IHRCs and compare them with EHRCs. My main proposal is that in Korean IHRCs, the internal head moves at LF (or after Spell-out) and both IHRCs and EHRCs have the same LF forms; that is, EHRCs and IHRCs have the same logico-semantic meaning. I argue, however, that EHRCs and IHRCs differ from each other in their pragmatic meaning. I propose that EHRCs and IHRCs have the same propositional content, but have different cognitive representations, which are called 'thetic' and 'categorical' judgments, respectively (Kuroda, 1972, 1990; Sasse, 1987; Raposo & Uriagereka, 1995).

This paper is organized as follows: In section 2, I review the literature on the structure of IHRCs and argue for the view that there exists a head external

to the embedded clause at LF. In section 3, I discuss the structure of Korean IHRCs and support the view that I argue for in section 2. In section 4, I discuss the difference between EHRCs and IHRCs in Korean in terms of thethetic/categorical distinction. Section 5 concludes the paper.

2. Previous Approaches to IHRCs

There are two different proposals with regard to the head position of IHRCs. One view, which is suggested by Cole (1987) for Quechua and Hoshi (1996) for Japanese, proposes that there exists an empty head external to the embedded clause, and that this head is coindexed with the internal head. Cole (1987) further proposes that the internal head moves to the empty head position at LF. The other view, which is suggested by Williamson (1987) for Lakhota, Barss et al. (1991) for Navajo, and Basilico (1996) for the Yuman and Northern Athabaskan languages, proposes that there is no head external to the embedded clause; the internal head moves either at LF or SS, but stays within the embedded clause. In the following subsections, I will review the two approaches.

2.1. Empty head external to the embedded clause

Cole (1987) proposes the following as the SS and LF structures of IHRCs in Quechua:

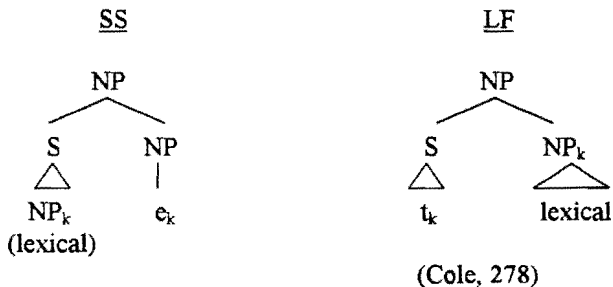

Cole argues that the S-structure with an empty head is possible in SOV languages if the following restriction on anaphors is assumed:

An anaphor cannot both precede and command its antecedent.
(Cole, 283)

In the S-structure, the empty head NP commands its antecedent, but does not precede it, so the sentence is grammatical. SVO languages do not have an IHRC because an empty head external to the embedded clause will both command and precede its antecedent, and violate the proposed condition on anaphors.

Cole further proposes that the internal head moves to the external head position at LF. His argument is based on ECP and subjacency effects. In Quechua, extraction of the subject from an IHRC results in an ungrammatical sentence, while extraction of the object does not, as illustrated in the following examples:

3. [Marya [Juan **wawa-ta** riku-shka] -ta
 Maria Juan child-acc see-nominal-acc
 ni-skha] llughshi-rka.
 say-nominal leave -past
 'The child that Maria said that Juan saw left.'
4. *[Marya [**warmi** Juan-ta riku-shka] -ta
 Maria woman Juan-acc see-nominal-acc
 ni-skha llughshi-rka.
 say -nominal leave -past
 'The woman that Maria said that saw Juan left.'

(Cole, p 297)

The ungrammaticality of (4), according to Cole, can be explained only if LF movement of the internal head is assumed. The asymmetry between (3) and (4) is due to the violation of the ECP in the case of subject extraction. When an object moves at LF out of the embedded clause, its trace is governed by the verb, which assigns a theta role to the object. On the other hand, when a subject moves out of the embedded clause, the trace is not properly governed either by its antecedent or by any theta role assigning head.

Hoshi (1996) is another study which proposes the existence of an empty head external to the embedded clause. Supporting evidence for the empty head, according to Hoshi, comes from the distribution of floating quantifiers. It has been observed that floating quantifiers in Japanese are restricted by a locality condition, which states:

FQs are licensed only when FQs and host NPs are in mutual c-commanding relation. (Ueda, 1986; Miyagawa, 1989)

The contrast between (5) and (6) shows that violation of the locality condition results in an ungrammatical sentence:

5. sono doroboo-wa [[**hooseke-ga mittu** [e]_j kakusiteatta]
 that thief - top jewel-nom three had been hidden
 kinko_j]-o nusunda.
 safe- acc stole.
 'That thief stole the safe in which three (of the) jewels had been hidden.'

6.* sono doroboo-wa [[**hooseki-ga** [e]_j kakusiteatta]
 that thief-top jewel-nom had been hidden
 kinko_j] -o **mittu** nusunda.
 safe-acc three stole.
 'That thief stole the safe in which three (of the) jewels had been hidden.'
 (Hoshi, 259)

In (5) the FQ *mittu* 'three' is in a mutual c-command relation with its head *hooseke* 'jewel', and the sentence is grammatical. In (6), on the other hand, the FQ *mittu* 'three' moves out of the relative clause and it is not in a c-commanding position with regard to the head any longer, hence the sentence is ungrammatical. When an FQ occurs in an IHRC, the situation is different; the FQ can float out of the embedded clause and stand alone external to the embedded clause:

7. Ken-wa [[Risa-ga teeburu-no ue-ni **ringo-o mittu** oiteoita]no]-o
 top nom table-gen on apple-acc three had put-acc
 totte tabeta.
 picked up and ate.
 'Risa had put three apples on the table and Ken picked up and ate them.'

8. Ken-wa [[Risa-ga teeburu-no ue-ni **ringo-o** oiteoita]no]-o
 top nom table-gen on apple-acc had put- acc
mittu totte tabeta.
 three picked up and ate.
 'Risa had put three apples on the table and Ken picked up and ate them.'
 (Hoshi, 260)

In (7), the FQ is local to the associated NP, which is the head of the IHRC, and the sentence is well formed. In (8), the FQ occurs in the matrix clause, far away from its associated NP. Though the locality condition on the FQ and its associated NP is not satisfied, the sentence is well-formed. Hoshi argues that in order to explain the grammaticality of (8), the existence of an empty head, which is coindexed with the head of the IHRC, should be assumed in the matrix clause next to the FQ. Though Hoshi proposes the existence of an external covert head in the IHRC, he does not assume that the internal head moves at LF. I will propose in section 3 that there is no external empty head at SS,

but the internal head moves at LF and the locality condition on the FQ is satisfied at LF.

2.2. No external head

In contrast to the external head analysis, there is another proposal which does not assume an external head. For example, Basilico (1996), in his discussion of IHRCs in some Amerindian languages, proposes that the internal head moves overtly out of the VP of the embedded clause, but the landing site is within the embedded clause. His main argument is based on the view that the IHRC is not a case of relativization semantically, but a case of quantification: the IHRC is associated with quantificational elements that bind variables within the embedded clause. For example, in the following Diegueño relative clause, the demonstrative *-pu* functions as an operator which binds the variable within the relative clause. Thus, (a) is interpreted as (b):

- 9.a. i:pac 'wu:w-pu-c
 man I.saw-DEM-SUBJ
 ' the man that I saw'
 b. $\iota(x)$ [man (x) & I saw (x)]
 (Basilico, 507)

It has been claimed (Williamson, 1987; Basilico, 1996) that due to the quantificational nature of the IHRC, there is a restriction on the internal NP head in these languages; that is, the internal head NP should be indefinite. Basilico explains the definiteness effect and the movement of the internal head in the following way: as an operator, the demonstrative has to bind a variable in order to avoid vacuous quantification. According to Heim (1982), an indefinite does not have any quantificational force of its own, but is a variable, which is bound by an operator. If the indefinite does not move out of the VP, it will be bound by an existential operator. Thus, in order to avoid existential closure and vacuous quantification of the iota operator, the indefinite NP has to move out of the VP, a la Diesing's (1992) Mapping Hypothesis.

I will show below that in Korean the definiteness effect does not hold, and the internal head moves and lands externally to the embedded clause at LF. I will also assume that the EHRC as well as the IHRC can be quantificational, following the Russellian view of definite descriptions. Thus, both the IHRC and the EHRC form the same tripartite semantic structure at LF, which is proposed as the structure of EHRCs by Partee (1976)³ and Neale (1990), and of IHRCs by Basilico (1996):

quantifier	restrictor	scope
the	man	I saw
$\iota(x)$ [man (x) & I saw (x)]		

3. Structure of Korean IHRCs

I have proposed above that there is an external empty head at LF in Korean IHRCs. The first evidence for the existence of an external semantic head in IHRCs can be found in the comparison of IHRCs and event nominalizations discussed in Hirose (1992). Hirose notes that in Japanese, IHRCs and event nominalizations are syntactically very similar: neither has a gap in the embedded clause; both are marked with the complementizer *no* and case particle; and both function as the syntactic argument of a main predicate. However, she also notes that in the case of event nominalizations, the embedded clause itself can be a semantic argument of the predicate, while in the case of IHRCs, the internal head, not the whole relative clause, is the semantic argument of the main predicate. The same similarities and contrasts are also found in Korean, which are illustrated in the following examples of event nominalization (10) and IHRC (11):

10. John-un [kay-ka tallyo-oko-iss-nun] kes]-ul an-ta.
 top dog-nom run -come-be-ing comp-acc know-decl.
 'John knows that a dog is coming running'
11. John-un [kay-ka tallyo-oko-iss-nun] kes]-ul chap-ass-ta.
 top nom run-come-be-ing comp-acc catch-past-decl
 'John caught a dog that was coming running.'

In (10) the embedded clause, which is marked with the complementizer *-kes* and the accusative case marker *-ul*, is both the syntactic and semantic argument of the main verb. On the other hand, in (11), though the embedded clause is a syntactic argument of the main predicate, the semantic argument of the main verb is the internal head *kay* 'dog' and the relative clause is a modifier of the head. This suggests that there has to be an external head at some interpretive level.

The distribution of floating quantifiers, which parallels that discussed in Hoshi (1996), is further evidence supporting the existence of an external head. I agree with Hoshi (1996) that an FQ needs to be in mutual c-command relation with the associated NP, but I would argue, based on the data I will discuss below, that the c-command relation is formed at LF after head raising.

12. Mary-nun [e₁ table-uyey iss-nun] sakwa₁]-lul sey-kay⁴ mek-ess-ta.
 top table-on exist apple-acc three-CL eat-past-decl.

13. Mary-nun [sakwa-ka table-uyey iss-nun] kes]-ul sey-kay mek-ess-ta
 top apple-nom table-on exist comp-acc three-CL eat-past-decl.
 'Mary ate three apples that were on the table.'

In (12), the head of the EHRC is in mutual c-command relation with the FQ *sey-kay* 'three' and the sentence is well formed. In (13) the FQ *sey-kay* 'three' is distant from the associated NP at SS, but the sentence is still grammatical. The grammaticality can be explained by assuming that the associated NP moves at LF and licenses the FQ in a c-command relation⁵.

I assume, for the following reasons, that there is no empty head external to the IHRC at SS, but the head moves at LF. First, I argue, following Whitman (1990, cited in Lee 1992), that the structure proposed by Cole (1987), in which an external empty head exists at SS, is not possible due to a violation of Condition C. Cole's condition on the distribution of anaphors, which is repeated below, might allow the licensing of the empty head:

An anaphor cannot both precede and command its antecedent.
 (Cole, 283)

However, this condition cannot rescue the internal head from violating Condition C; the null pronominal head would bind the internal head at S-structure, resulting in a Condition C violation. However, if we assume that the internal head moves at LF to the external head position and binds its trace, there will be no violation of binding conditions.

The claim that the internal head raises at LF to a position external to the embedded clause may find support in the fact that in Korean the internal head can be a definite NP. Contrary to the proposal by Williamson (1987) that the internal head of IHRCs would be universally indefinite, the internal head in Korean IHRCs can be either indefinite or definite. Thus, the definiteness effect does not hold in Korean. Since Korean does not have definite/indefinite articles, demonstratives, which can occur optionally, play a role similar to the definite article in English:

14. John-i [ku totwuk-i pang-eyse nao-n] kes]-ul cap-ass-ta.
 nom the thief -nom room-from come out-comp-acc catch-past-decl.
 'John caught the thief who was coming out of a room.'
15. Mary-ka [ku cip- ul pha-n] kes]-i John-eyuyhay
 nom the house-acc sell -rel -comp-nom by
 kwiip-toy-ess-ta.
 buy-pass-past-decl.
 'The house that Mary sold was bought by John.'

Seeing that a Korean IHRC allows a definite NP as a head, there does not seem to be enough evidence so support the view that the internal head stays within the embedded clause to be bound by an operator. Thus, I will assume that the head moves outside the embedded clause at LF, and forms the semantic tripartite structure⁶.

4. Pragmatics of EHRCs vs. IHRCs

I have proposed that in Korean the internal head of the IHRC moves at LF, giving the IHRC the same LF form as the EHRC, so that both have the same logico-semantic meaning. Then a question we want to ask is why a language should have two different syntactic forms to convey one and the same meaning. I would like to suggest that the two structures are different in their non-logico-semantic meaning; that is, they differ in their pragmatic meaning. My proposal is that an EHRC is the manifestation of categorical judgment, while an IHRC conveysthetic judgment. In the following subsections I will discuss thethetic/categorical distinction and its relation to the two relative clause constructions in Korean.

4.1. Thetic/categorical judgment

Thetic and categorical sentences are two different sentence types which manifest two different cognitive representations of the same propositional content. Categorical judgment is composed of two successive acts; naming an entity and making a statement about it. On the other hand,thetic judgment expresses an event, or state, or situation without distinguishing the entity and its description of it. According to Kuroda (1972, 1990), categorical andthetic judgments are distinguished in Japanese by the particles *-wa* and *-ga*. For example, the difference between the two sentence type is analyzed by Kuroda as follows:

16. Inu-wa hasitte-iru.
dog-top running is

17. Inu-ga hasitte-iru.
dog-nom running is
'The/A dog is running.'

In (16), which is a categorical judgment sentence, the speaker pays attention to the entity, the dog, and then she comments on what the dog is doing. In (17), on the other hand, the focus is on the event, 'dog be running.'

In Korean, the particles *-nun* and *-ka* have the same function as the Japanese *-wa* and *-ga*, respectively:

18. *kay-nun taliko-issta.* (categorical)
dog-top running is

19. *kay-ka taliko-issta.* (thetic)
dog-nom running is
'The /A dog is running.'

According to Sasse (1987), a test for theticity is whether a sentence can be an answer to the question "what's happening?". In Korean, the sentence with the particle *-ka* is a natural answer to the same question:

20. Q: *mwusun il-i iss-ni?*
what thing-nom be-Q?
'what's happening?'

A: *kay-ka taliko-issta.* (thetic)
dog-nom running is.

* *kay-nun taliko-esse.* (categorical)
dog-top running is
'The/A dog is running.'

The converse would be true if the question were "What is the dog doing?"

21. Q: *kay-ka mwues-ul hako-iss-ni?*
dog-nom what -acc doing is -Q?
'what is the dog doing?'

A: *kay-ka taliko-issta.* (thetic)
dog-nom running is.

kay-nun taliko-esse. (categorical)
dog-top running is
'The/A dog is running.'

Though the sentence with the particle *-ka* is not ungrammatical and can also be an answer to the question, the sentence with the particle *-nun* sounds better.

4.2. IHRC: thetic vs. EHRC: categorical

It seems that the *thetic/categorical distinction* is not uncommon across languages⁷, and that the IHRC/EHRC constructions in Korean are another example where the two judgment types show up syntactically. Let's consider again the Korean IHRC and EHRC:

22. John-i [pang-eyse nao-n] totwuk]-ul cap-ass-ta.
 nom room-from come-rel thief -acc catch-past-decl
23. John - i [totwuk-i pang-eyse nao-n] kes]-ul cap-ass-ta.
 nom thief-nom room-from come rel-comp-acc catch-past-decl.
- ' John caught the thief who came out of the room.'

In (22) the semantic head is external to the embedded clause. If we assume that the relation between what is relativized and the proposition expressed by the relative clause is that of topic and comment (Kuno, 1973; Lambrecht, 1988), in the EHRC (22) *totwuk* 'a thief' corresponds to the topic and *pang-eyse naon* 'who came out of the room' to the comment. In this construction, the entity 'the thief' is singled out, that is, it is the focus of attention, and comment about that entity is added. In the IHRC (23), the semantic head is located internal to the embedded clause. The entity is not singled out, but is a part of the whole event, 'a thief coming out of the room.' When asked "what's happening?", a more natural answer would be (23), while to the question, "who did John catch?", (22) would be a better answer⁸.

In Korean the demonstratives -- *i* 'this', *ku* 'the', *ce* 'that' -- may cooccur with a relative clause before the head noun it modifies, and the order can be either [Dem+RC+ Head] or [RC +Dem+ Head], though the [RC+Dem+ Head] order is more common. When the demonstrative occurs in front of the RC, the focus is on the whole [RC+ Head], while when the demonstrative comes before the Head, the focus falls on the head of the RC. I would suggest that the demonstrative before the [RC+ Head] increases the *theticity* of the relative clause, while the demonstrative in front of the Head noun increases the *categorical nature* of the RC.

As pointed out earlier, Williamson (1987) and Basilico (1996) note that the internal head tends to be indefinite in many languages, though in Korean a definite NP is also possible. One possible explanation for the definiteness effect can be found in the *theticity* of the IHRC. According to Sasse (1987), the entity which is part of the whole event in a *thetic judgment* is more likely to occur as an indefinite NP in order to be incorporated into the event and avoid being singled out. It seems that the relative clause constructions in Korean differ from each other in the degree of *theticity* and the *referentiality* of the head noun, as can be seen in the following scale:

thetic <===== <=====> categorical
 non-referential Head referential Head
 IHRC>>Dem+RC+Head >>RC+Head>>RC+ Dem +Head>>non restrictive RC

5. Concluding Remarks

In this paper, I have proposed that in Korean IHRCs, the internal head moves at LF externally to the embedded clause, and that as a result, both EHRCs and IHRCs have the same LF forms and the same propositional content. However, the two relative clause constructions differ in their pragmatic meanings; the EHRC conveys categorical judgment, while the IHRC conveys thetic judgment. It has been claimed that some languages have a more explicit relation between syntax and Information Structure (IS)⁹, a level at which pragmatic meaning is computed (Vallduvi, 1995). The analysis I have presented here seems to support the position that IS is a linguistic level of representation, distinct from LF, and that Korean relative clauses are syntactic constructions where the interaction between SS and IS is apparent.

Notes

* I would like to thank Rudolph Troike for valuable comments and suggestions.

1. Abbreviations used in this paper:

acc: accusative case	comp: complementizer	decl: declarative
nom: nominative case	past: past tense	top:topic
CL: classifier	pass:passive	rel: relativization

² There have been several different approaches to the gap in the EHRC in Korean; e.g. simple deletion, NP movement to the head, zero resumptive pronoun hypothesis, and null operator movement. It is beyond the scope of this paper to evaluate each approach. For the purpose of this paper, what is important is that all the approaches assume an external head, which is coindexed with the gap (see Lee (1991) for a review of the approaches).

³ Partee (1976) does not use the tripartite structure explicitly. She defines the meaning of the RC 'the man I saw' as 'there is an entity that is both a man and that I saw.'

⁴ The FQ can occur in front of the head or the RC, but in this case the FQ needs to have a genitive case marker:

[e_i table-uyey iss-nun] sey-kay-ui sakwa₁
 [sey-kay-ui e_i table-uyey iss-nun] sakwa₁

⁵ The LF forms can be either (a), or (b) after deletion of comp *-kes* and the accusative marker *-ul*. I assume both sentences have the same logico-semantic meaning since the functional morphemes do not play a significant role at the interpretive level.

- a. Mary-nun [e₁ table -uyey iss-nun] kes]-ul sakwa-lul sey-kay mek-ess-ta
 top table-on exist comp-acc apple-acc three-CL eat-past-decl.
 b. Mary-nun [e₁ table -uyey iss-nun] sakwa-lul sey-kay mek-ess-ta
 top table-on exist apple-acc three-CL eat-past-decl.

'Mary ate three apples that were on the table.'

⁶ I assume that both a definite and indefinite NP moves outside the embedded clause at LF. If we assume, following Higginbotham (1987), that in a definite NP, the open position is bound by the definite article and is closed, the NP cannot be bound by another operator and can move outside the embedded clause at LF. In contrast, an indefinite NP, which has an open position and needs to be bound by an operator stays within the RC. In this approach, IHRCs have two different LF forms depending on the definiteness of the head. I will leave it for future study to investigate different semantic effects between the two forms, if there are any.

⁷ Another example where the *thetic/categorical* distinction may show up syntactically is discussed in Basilico (1998). In his discussion of verb argument alternations in creation/transformation, locative, and dative constructions, Basilico suggests that the alternate forms differ in that one form represents *thetic*, while the other represents *categorical* judgment. For example, in the following dative alternation, (21a), in which the order is [verb+ direct object+prepositional phrase], represents *thetic* judgment; on the other hand, (21b), where the indirect object is followed by the direct object, manifests *categorical* judgment:

- a. The instructor gave a book to the student. (*thetic*)
 b. The instructor gave the student a book. (*categorical*)
 (Basilico, 543)

In (a) the inner predication conveys *thetic* judgment, which involves an event of a book coming to be at the student's location. The whole event, without singling out any individual entity, is the locus of focus. In (b) the student is singled out and the property of having a book is attributed to the student.

⁸ Some Korean speakers may accept (22) as an appropriate answer to the question "What's happening?". The point is that (23) is the better answer.

⁹ Vallduví proposes the following as a revised version of the T-model:

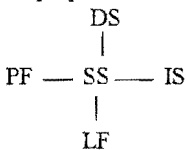

He proposes that Catalan is a language where IS and SS are closely related, while in English IS and PF interaction is apparent.

References

- Barss, Andrew; Kenneth Hale; Ellavina Perkins; and Margaret Speas. 1990. 'Logical form and barriers in Navajo', In C-T. Huang and R. May, eds., *Logical Form: Cross-linguistic Perspectives*, 25-47. Dordrecht: Kluwer.
- Basilico, David. 1996. 'Head position and internally headed relative clauses', *Language*, 72. 498-532.
- Basilico, David. 1998. 'Object position and predication forms', *Natural Language and Linguistic Theory*, 16. 541-595.
- Cole, Peter. 1987. 'The structure of internally headed relative clauses', *Natural Language and Linguistic Theory*, 5. 277-302.
- Heim, Irene. 1982. *The Semantics of Definite and Indefinite Noun Phrases*. Doctoral Dissertation, University of Massachusetts, Amherst.
- Higginbotham, James. 1985. 'On semantics', *Linguistic Inquiry*, 16. 547-594.
- Higginbotham, James. 1987. 'Indefiniteness and predication', In In E. Reuland and A.G.B. ter Meulen, eds., *The Representation of Indefinites*, 43-70. Cambridge, MA: MIT Press.
- Hirose, Kyoko. 1992. 'On Japanese internally headed relative clauses', *Berkeley Linguistic Society*, 20. 100-108.
- Hoshi, Koji, 1996. 'The head-internal relative clause in Japanese: An empty head noun approach', *Japanese/Korean Linguistics*, 5. 253-268.
- Kuroda, Y-S. 1972. 'The categorial and the thetic judgment: Evidence from Japanese syntax', *Foundations of Language*, 9. 153-185.
- Kuroda, S-Y. 1990. 'The categorial and the thetic judgment reconsidered', In K. Mulligan, ed., *Mind, Meaning and Metaphysics: The Philosophy and Theory of Language of Anton Marty*. Dordrecht: Kluwer.
- Lambrecht, Kund. 1988. 'Sentence focus, information structure, and the thetic-categorial distinction'
- Lee, Kwee-ock. 1991. *First Language Acquisition of Relative Clauses in Korean: The Universal Structure of Comp*. Doctoral Dissertation, Cornell University.
- Neale, Stephen. 1990. *Descriptions*. Cambridge, MA: MIT Press.
- Partee, Barbara. 1976. 'Some transformational extensions of Montague Grammar', In B. Partee, ed., *Montague Grammar*. New York: Academic Press.
- Raposo, Eduardo. and Juan Uriagereka. 1995. 'Two types of small clauses: Toward a syntax of Theme/Rheme relations', In A. Cardinaletti and M.T. Guasti, eds., *Syntax and Semantics 28: Small Clauses*, 179-206. New York: Academic Press.
- Sasse, Hans-Jurgen. 1987. 'The thetic/categorial distinction revisited', *Linguistics*, 25. 511-580.
- Vallidui, Enric. 1995. 'Structural properties of information packaging in Catalan'. In K.E. Kiss, ed., *Discourse Configurational Languages*, 122-151. New York: Oxford University Press.
- Williamson, Janis. 1987. 'An indefiniteness restriction on relative clauses in Lakhota', In E. Reuland and A.G.B. ter Meulen, eds., *The Representation of Indefinites*, 168-190. Cambridge, MA: MIT Press.

Focus Movement and *WH*-Questions in Malagasy*

Ileana Paul
McGill University

This paper examines multiple *wh*-fronting in Malagasy and argues that both *wh*-elements appear in a single specifier position. The two *wh*-elements are adjoined to each other and surface in the specifier of a focus projection.

Like in many other Austronesian languages, Malagasy *wh*-movement is a subtype of focus movement (compare with Palauan: Georgopoulos (1991) and Madurese: Davies (1998)). Typical examples are given in (1).

- (1) a. **Iza** no nanoroka an'i Soa?
 who foc pst.AT.kiss acc.Soa
 Who kissed Soa?
- b. **Oviana iza** no nanoroka an'i Soa?
 when who foc pst.AT.kiss acc.Soa
 When did who kiss Soa?

Unlike the languages mentioned above, however, Malagasy allows multiple foci, as in (1b). I argue that *wh*-questions involve movement to the specifier of a focus projection, headed by the focus particle *no*. (2) gives the proposed structure for (1b). (Note that Malagasy is VOS.)

- (2) [FocP oviana_j iza_i no [IP nanoroka an'i Soa t_j t_i]]
 when who foc kissed acc.Soa

In Malagasy, the adjunct *oviana* 'when' may adjoin to the subject NP *iza* 'who', both fronting as a constituent to the specifier position. Such adjunction is not possible in Palauan and Madurese, thus accounting for the difference between the languages.

To better understand the data discussed in this paper, I begin with some background on Malagasy.

* This paper would not exist without the insight and judgements of Saholy Hanitriniaina. I would like to thank Hidekazu Tanaka, Lisa Travis and the audience at WECOL for helpful suggestions. Funding for this research was from FCAR. Any errors remain my own.

0. Malagasy

Malagasy is a western Malayo-Polynesian language spoken on the island of Madagascar. Central to the grammar are the voice alternations in (3).

- (3) a. Actor Topic (AT)
 Manasa lovia telo amin'ny savony Rakoto.
 AT.wash dish three with'the soap Rakoto
 'Rakoto washes three dishes with the soap.'
- b. Theme Topic (TT)
 Sasan-dRakoto amin'ny savony ny lovia telo.
 TT.wash.gen.Rakoto with'the soap the dish three
 'The three dishes are washed by Rakoto with the soap.'
- c. Circumstantial Topic (CT)
 Anasan-dRakoto lovia telo ny savony.
 CT.wash.gen.Rakoto dish three the soap
 'The soap is used by Rakoto to wash three dishes.'

(3) illustrates a common paradigm; a single root can appear with one of three (or more) verbal voice affixes. In Actor Topic, the agent is the subject. This closely resembles the active of English and other well-known languages. With Theme Topic, the theme or patient is the subject, similar to passive. Circumstantial Topic is more unusual: almost any other element of the clause may be promoted to subject: instrumental (as in (3c)), locative, temporal adverb, benefactive, etc.

These voice alternations interact in an important way with the A-bar system of Malagasy: only subjects and adjuncts can extract. It is therefore impossible to directly question the object of an active verb, as shown by the ungrammaticality of (4a). Instead, the object is promoted to subject with TT and extraction occurs from this position, as in (4b).

- (4) a. *Inona_i no manasa t_i amin'ny savony Rakoto?
 what foc AT.wash with'the soap Rakoto
 'What does Rakoto wash with the soap?'
- b. Inona_i no sasan-dRakoto t_i amin'ny savony t_i?
 what foc TT.wash.gen.Rakoto with'the soap
 'What is washed by Rakoto with the soap?'

More generally, however, adjuncts can extract in any voice.¹ In other words, adjuncts can be questioned when the verb is AT (5a), TT (5b) or CT (5c).

- (5) a. Amin'inona no manasa lamba Rakoto?
with'what foc AT.wash cloth Rakoto
'What does Rakoto wash clothes with?'
- b. Amin'inona no sasan-dRakoto ny lamba?
with'what foc TT.wash.gen.Rakoto the cloth
'What are the clothes by Rakoto washed with?'
- c. Amin'inona; no anasan-dRakoto lamba t_i t_i ?
with'what foc CT.wash.gen.Rakoto cloth
'What is used by Rakoto to wash the clothes?'

In (5c) the adjunct has been promoted to subject by CT morphology and then fronted.

These restrictions on extraction hold strictly and therefore affect "long-distance" extraction. Subject extraction is clause-bound: only matrix subject may extract or, crucially, subjects of sentential subjects. (6a) illustrates ungrammatical subject extraction from a CP object. (Note that CP objects appear to the right of the matrix subject, giving VSO_{CP} word order.) Passivizing the matrix verb makes (6b) grammatical. Further embedding is possible, provided that all intervening verbs are passive, as in (6c).²

- (6) a. *Iza no manantena Raso fa nanasa lamba?
who foc AT.hope Raso C pst.AT.wash cloth
'Who does Raso hope washed clothes?'
- b. Iza no antenain-dRaso fa nanasa lamba?
who foc TT.gen.Raso C pst.AT.wash cloth
'Who does Raso hope washed clothes?'
- c. Iza; no lazain'i Bakoly [fa nantenain'i Sahondra [fa
who foc TT.say.gen.B C pst.TT.hope.gen.S C
norohan-dRaso t_i]]?
pst.TT.kiss.gen.R
'Who does Bakoly say that Sahondra hoped that Raso kissed?'

¹ There are some exceptions, which remain poorly understood. For example, when *manao ahoana* 'how' appears in the fronted position, CT morphology is obligatory.

² Chung (1982), Georgopoulos (1991) and Cole and Hermon (to appear) analyze this pattern of verb morphology as an instantiation of "wh-agreement". I follow the more traditional approach and treat the morphology on a par with voice, hence relating to A-movement.

(6b,c) are somewhat surprising given standard assumptions about extracting out of subjects (e.g. the Condition on Extraction Domains of Huang (1982)).

There is, however, a simple explanation for the grammaticality of (6b) which does not invoke a CED violation. Keenan (1976) points out that sentences such as (6b) arguably involve subject-to-subject raising. This raising is shown schematically in (7).

- (7) Iza_i no [[antenain-dRaso_a [fa nanasa lamba t_i]] t_i?
 who foc TT.gen.Raso_a C pst.AT.wash cloth
 ‘Who does Raso_a hope washed clothes?’

In other words, in (7), the subject of the embedded clause has raised into the matrix clause via A-movement. Once in the matrix subject position, extraction is possible. I will not review the arguments for subject raising here, but refer the reader to Keenan (1976) and Paul (1998).

In distinction to subjects, adjunct extraction is strictly clause-bound. It is clearly ungrammatical to extract an adjunct out of an embedded CP object, as in (8a). Passivizing the matrix verb does not improve the grammaticality, as shown by (8b).³ (8b) therefore contrasts with (6b): subjects but not adjuncts may extract out of (apparent) sentential subjects. For long-distance movement of an adjunct, the matrix verb must be passive and the embedded verb in CT, as illustrated in (8c).

- (8) a. * Taiza no manantena Raso_a fa nanasa lamba Rakoto?
 pst.where foc AT.hope Raso_a C pst.AT.wash cloth Rakoto
 ‘Where does Raso_a hope Rakoto washed clothes?’
- b. ??Taiza no antenain-dRaso_a fa nanasa lamba Rakoto?
 pst.where foc TT.hope.gen.R C pst.AT.wash cloth Rakoto
 ‘Where does Raso_a hope Rakoto washed clothes?’
- c. Taiza no antenain-dRaso_a fa nanasan-dRakoto lamba?
 pst.where foc TT.hope.gen.R C pst.CT.wash.gen.R cloth
 ‘Where does Raso_a hope Rakoto washed clothes?’

CT morphology in (8c) promotes the adjunct to subject and then subject-to-subject raising obtains, parallel to (6b).

Summing up, Malagasy subjects and adjuncts may undergo short (clause-bound) A-bar extraction. Apparent examples of long-distance movement involve A-movement followed by A-bar movement. See Davies (1998) for similar

³ In fact, examples such as (8b) are sometimes judged grammatical. There is variation depending on the adjunct and the matrix verb. But the same sentence may be judged grammatical and ungrammatical on different occasions by the same speaker. There is, however, a clear contrast with the “bodyguard” examples discussed below, which are uniformly grammatical.

conclusions for Madurese. These restrictions on extraction will play a crucial role in the following discussion of multiple *wh*-questions.

1. *Wh* Questions

In this section, I will survey the different types of *wh*-questions in Malagasy and explore some of the characteristics of movement.

1.1 Strategies

In Malagasy, as in many of the languages in this family, there are three basic question formation strategies. In the first, the *wh*-element appears in-situ. Thus in (9), *inona* 'what' surfaces in its base direct object position within the embedded clause but takes matrix scope.

- (9) Manantena Rasoa [fa nanasa **inona** Rakoto]?
 AT.hope Rasoa C pst.AT.wash what Rakoto
 'What does Rasoa hope Rakoto washed?'

Since the focus of this paper is on movement, I will not discuss the in-situ strategy any further. Second, the *wh*-element may be fronted. In (10), for example, *iza* 'who' appears in its scopal position.

- (10) **Iza**_i no antenain'i Bakoly [fa norohan-dRasoa t_i]?
 who foc TT.hope.gen.Bakoly C pst.TT.kiss.gen.Rasoa
 'Who does Bakoly hope that Rasoa kissed?'

Note that *wh*-fronting is a kind of focus movement; the *wh*-element is immediately followed by the focus particle *no*. Third, Malagasy exhibits partial movement, as shown in (11). The *wh*-word appears neither in its base position nor in its scopal position. Thus although (11) is a matrix question, *iza* 'who' has only fronted to an intermediate focus position.

- (11) Manantena Rasoa [fa **iza**_i no nanasa lamba t_i]?
 AT.hope Rasoa C who foc pst.AT.wash cloth
 'Who does Rasoa hope washed the clothes?'

Such partial movement has been discussed for languages such as German and Hungarian (see McDaniel (1989) and Horvath (1997)). In these languages, however, there surface "scope markers" which indicate the scope of the partially moved element. No such "scope markers" are evident in Malagasy or in other languages of this family that exhibit partial movement (e.g. Malay, Palauan, Madurese).

As an interesting variant on movement, two *wh*-elements may front

simultaneously. This possibility is illustrated in (12). Note that in both cases, the adjunct precedes the subject; this is the only possible ordering.

- (12) a. **Nahoana iza no lasa nody?**
 why who foc left pst.go-home
 ‘Why did who go home?’
- b. **Taiza iza no nividy io boky io?**
 pst.where who foc pst.AT.buy this book this
 ‘Who bought this book where?’

Structures such as those in (12) are described by Keenan (1976), who refers to such multiple fronting as the “bodyguard condition”.

- (13) Bodyguard Condition (Keenan (1976)):
 when a non-subject is fronted in a cleft, it can optionally be accompanied by the grammatical subject

Intuitively, since subject extraction is always possible, a subject can “carry along” an adjunct in fronting. Such multiple movement is also available in embedded clauses. Examples are given in (14): (14a) is an example of partial multiple movement; (14b) illustrates multiple movement in an embedded question.

- (14) a. **Manantena Raso fa taiza iza no nividy ilay boky?**
 AT.hope Raso C pst.where who foc pst.AT.buy the book
 ‘Who does Raso hope bought the book where?’
- b. **Manontany tena Raso fa mba oviana iza no nandeha.**
 AT.ask self Raso C C when who foc pst.AT.go
 ‘Raso wonders who left when.’

The goal of this paper is to investigate the structure of multiple fronting. The following section gives the proposed structure for single and multiple fronting.

1.2 Proposal

As mentioned above, *wh*-movement is a sub-type of focus, not movement to [Spec, CP]. I therefore propose the projection Focus P, headed by the particle *no*. *Wh*-fronting is movement into the specifier of this projection.

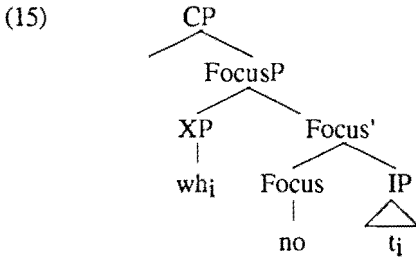

As evinced by the above examples with embedded focus, CP dominates FocusP, which in turn dominates IP. In multiple fronting, adjuncts may left-adjoin to subjects in [Spec, FocusP]. The structure is shown in (16).

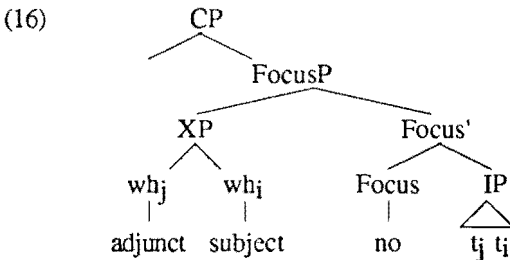

2. Data

I now turn to data that support the proposed structures in (15) and (16) and some consequences.

2.1 Non *wh* movement

Analyzing *wh*-movement as focus movement is directly motivated by (17), where a non-*wh* word appears in the pre-verbal focal position, followed by the particle *no*. These structures have the same properties as their *wh* counterparts (e.g. only subjects and adjuncts can front and fronting is clause-bound).

- (17) Rasoa no nanoroka an-dRakoto.
 Rasoa foc pst.AT.kiss acc-Rakoto
 'It's Rasoa who kissed Rakoto.'

Similarly, multiple foci are possible, as shown in (18). Again, the adjunct precedes the subject. In other words, non-*wh* adjuncts also left-adjoin to subjects.

- (18) Omaly Rasoa no nanoroka an-dRakoto.
 yesterday Rasoa foc pst.AT.kiss acc-Rakoto
 'It's yesterday that it was Rasoa who kissed Rakoto.'

The structures in (15) and (16) therefore account for all types of focus movement.

2.2 Word order

Assuming adjunction to be strictly to the left (as in Kayne (1995)), the structure in (16) explains the ordering between the adjunct and the subject. Placing the subject before the adjunct results in ungrammaticality. The examples in (19) thus contrast with those in (12).

- (19) a. * Iza nahoana no lasa nody?
 who why foc left pst.go-home
 'Why did who go home?'
 b. * Iza taiza no nividy io boky io?
 who pst.where foc pst.AT.buy this book this
 'Who bought this book where?'

Note that it is not possible to account for multiple fronting by proposing some form of covert coordination. When an overt conjunction is added, as in (20), the order of elements is reversed: subjects precede adjuncts. (20) contrasts with the standard bodyguard construction in (12).

- (20) Iza ary nahoana no lasa nody?
 who and why foc left pst.go-home
 'Who went home and why?'

Finally, adjunction must be limited to one element, again following Kayne (1995).⁴ This is shown by the fact that a maximum of two *wh*-elements may front.

- (21) * Nahoana taiza iza no nividy io boky io?
 why pst.where who foc pst.AT.buy this book this

As shown by the (22), the ungrammaticality of (21) is not due to some kind of parsing limitation: it is possible to have three *wh*-elements in a clause.

⁴ This limit requires stipulation. Descriptively, maximally one adjunct may adjoin to the subject. Under a Kaynian approach, adjunction is limited to one element, but a second adjunct could potentially adjoin to the first, rather than to the subject. I account for this by stating that in Malagasy adjuncts may only adjoin to subjects, not to adjuncts.

- (22) **Nahoana iza** no nivity io boky io **taiza?**
 why who foc pst.AT.buy this book this pst.where
 ‘Why did who buy this book where?’

Summing up, the structures proposed for *wh*-fronting account for the parallels between *wh*-questions and focus constructions, the rigid word order and the limit on the number of *wh*-elements in the focus position. The next section shows some consequences of this structure for movement.

3. Island constraints

It is well-known that *wh*-questions are subject to certain restrictions, often referred to as “island constraints”. Much of the syntactic literature on this topic has focussed on the precise formulation of these constraints and the correct explanation of the observed effects. In languages such as Malagasy, which have highly restricted movement possibilities, many of these effects are obscured. Nevertheless, because of full, partial and multiple movement, there remain interesting interactions to be studied.

3.1 Full and partial movement

The following example illustrates “long distance” movement of an embedded subject combined with partial movement of an adjunct. Clearly, partial movement does not create an island for full movement in this case.

- (23) **Iza_i** no nantenain-dRaso_a fa **oviana_j** no nody $t_i t_j$?
 who foc pst.TT.hope.gen.R C when foc pst.AT.go-home
 ‘Who did Raso_a hope went home when?’

On the other hand, if the subject undergoes partial movement and the adjunct raises into the matrix clause, the result is ungrammatical, as shown in (24).

- (24) * **Oviana_i** no nantenain-dRaso_a fa **iza_j** no nody $t_i t_j$?
 when foc pst.TT.hope.gen.R C who foc pst.AT.go-home
 ‘When did Raso_a hope that who went home?’

This section will provide an account for the contrast between (23) and (24).

First, note that verbs like ‘wonder’ create islands for movement. (25) illustrates ungrammatical *wh*-movement from a [+*wh*] clause.

- (25) * **Oviana_i** no manontany tena Raso_a fa mba **iza_j** no nody $t_i t_j$?
 when foc AT.ask self Raso_a C C who foc pst.AT.go-home
 ‘When does Raso_a wonder who went home?’

Similarly, a *wh* in-situ in a [+wh] clause takes narrow scope only.

- (26) a. Manontany tena Rasoa raha nividy inona Sahondra.
 AT.ask self Rasoa if pst.AT.buy what Sahondra
 'Rasoa wonders what Sahondra bought.'
 ≠ 'What does Rasoa wonder if Sahondra bought?'
- b. Manontany tena Rasoa fa mba iza no nividy inona.
 AT.ask self Rasoa C C who foc pst.AT.buy what
 'Rasoa wonders who bought what.'
 ≠ 'What does Rasoa wonder who bought?'

Standard *wh* island effects thus obtain with [+wh] verbs: both overt and covert movement is blocked. Partial movement, however, creates islands in certain cases only. The question then arises how to account for this split in island effects.

3.2 Bulgarian

Before answering the above question, I first turn to a language which has multiple *wh*-fronting: Bulgarian (Rudin (1988)). Several analyses of these types of languages have been proposed; I therefore briefly compare the properties of the Malagasy data with those of Bulgarian. Bulgarian is a reasonable point of comparison as, like Malagasy, the fronted *wh*-elements obey strict ordering. This is illustrated in (27).

- (27) Koj kakvo no kogo e dal?
 who what to whom has given
 'Who gave what to whom?'

(27), however, shows that Bulgarian differs in two important respects from Malagasy. First, the order of *wh*-elements is exactly the opposite of Malagasy: nominative>accusative>other. Recall that in Malagasy, the order is adjunct>subject. Second, Bulgarian allows more than two fronted elements, while in Malagasy the maximum is two. Moreover, it has been reported that Bulgarian lacks standard *wh*-island effects. As noted in the previous section, some (but not all) islands are relevant for Malagasy. Therefore, whatever account one posits for the Bulgarian multiple fronting, it is clearly not applicable to Malagasy.

3.3 Multiple Specifiers?

At this point, I would like to explore an alternate analysis of the Malagasy data that incorporates certain aspects of recent syntactic theory (see e.g. Ura (1996);

Richards (1997)). Under this approach, FocusP in Malagasy would have two available specifier positions, as illustrated in (28).

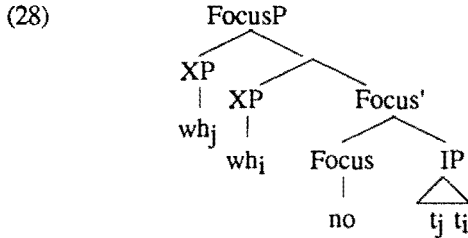

With two specifiers in FocusP for focussed elements, multiple fronting is directly accounted for. The main advantage of the multiple specifier analysis is that the extra position in [Spec, FocusP] can act as an “escape hatch”, allowing for *wh*-island violations. This is illustrated in (29). The subject can move through the intermediate spec position of FocusP. It is not blocked by the presence of the adjunct.

- (29) **Iza_j** no nolazain-dRaso_a fa **oviana_i** t_j no nanasa lamba t_j t_j?
 who foc pst.TT.say.gen.R C when foc pst.AT.wash cloth
 ‘Who did Raso_a say washed clothes when?’

The problem that arises immediately is how to account for the ungrammaticality of (30). If indeed there are two specs, the adjunct should be able to move through this intermediate position on its way to the matrix clause.

- (30) * **Oviana_i** no nolazain-dRaso_a fa t_j **iza_j** no nanasa lamba t_j t_j?
 when foc pst.TT.say.gen.R C who foc pst.AT.wash cloth
 ‘When did Raso_a say that who washed clothes?’

Invoking superiority does not solve the problem. As is clear by the positions of the intermediate traces in examples (29) and (30), the adjunct is structurally higher than the subject. Superiority would incorrectly rule out (29) and rule in (30). Moreover, an analysis based on multiple specs would have to explain the impossibility of extracting out of [+wh] clauses ((25) and (26)). I therefore conclude that an analysis based on multiple specs cannot adequately account for the Malagasy data.

3.4 Solution

To explain the contrast between (29) and (30), I suggest that it relates to the subject raising mentioned at the beginning of the paper. I claim that subjects undergo obligatory A movement to the matrix clause (perhaps to satisfy an EPP feature). That raising is obligatory can be seen in (31a).

- (31) a. *Nantenain-dRasoa fa iza no nanasa lamba?
 pst.TT.hope.gen.Raso C who foc pst.AT.wash cloth
 'Who did Raso hope washed clothes?'
 b. Nantenain-dRaso fa taiza no nanasa lamba Rakoto?
 pst.TT.hope.gen.R C pst.where foc pst.AT.wash cloth Rakoto
 'Where did Raso hope Rakoto washed clothes?'

(31a) has a matrix passive and a CP object with partial movement of the embedded subject. Assuming subject raising, the subject must have lowered from the matrix [Spec, IP] to the intermediate [Spec, FocusP]. Alternatively, subject raising has not occurred and the EPP feature of the matrix clause is not satisfied. In (31b), on the other hand, subject raising obtains and the adjunct is permitted to undergo partial movement to the intermediate [Spec, FocusP]. (30) is therefore ungrammatical, not because of island effects, but because in general, partial movement of subjects is ruled out. As we will see directly below, (30) is also ruled out due to the ban on long-distance adjunct movement.

Recall that adjunct movement is clause-bound. (32) is therefore ungrammatical with an embedded reading for *taiza* 'where'.

- (32) *Taiza no nantenain-dRaso fa oviana no nandeha Rabe?
 pst.where foc pst.TT.hope.gen.R C when foc pst.AT.go Rabe
 'Where did Raso hope that Rabe went when?'

If the embedded verb bears CT morphology, however, the sentence is grammatical, as in (33).

- (33) Taiza no nantenain-dRaso fa oviana no nandehanan-dRabe?
 pst.where foc pst.TT.hope.gen.R C when foc pst.CT.go.gen.Rabe
 'Where did Raso hope that Rabe went when?'

In fact, in (33) the adjunct *taiza* 'where' becomes the embedded subject by CT morphology. Subject to subject raising applies, raising the adjunct into the matrix clause. From this position, extraction may take place. Partial movement of the adjunct *oviana* 'when' does not interfere with extraction since the intermediate steps are via A positions. In other words, (33) is parallel to (29). The only other circumstance that permits "long-distance" adjunct extraction is when the adjunct is accompanied by subject fronting, as in the bodyguard construction in (34).

- (34) Taiza iza no nantenain-dRaso fa nividy ilay boky?
 pst.where who foc pst.TT.hope.gen.Raso C pst.AT.buy the book
 'Who did Raso hope bought the book where?'

To account for the grammaticality of (34), I propose that the adjunct may adjoin to the subject within the embedded clause. Both elements may then undergo raising to the matrix subject position and then extract as a unit. Adjunct extraction may then “piggy-back” on subject raising. I discuss the bodyguard condition in more detail in Paul (1998).

3.5 More Data

The proposed analysis of multiple fronting accounts for the fact that the two *wh*-elements need not originate in the same clause. (35a) illustrates adjunct movement from the embedded clause combined with matrix subject movement. This is clearly ungrammatical. In (35b), on the other hand, the adjunct undergoes short movement from the matrix clause, which is permitted. As for the embedded subject, it is first raised into the matrix clause and A-bar extracted from this position. Finally, (35c) shows grammatical long-distance movement of a subject and adjunct from the embedded clause. As in (34), the result is grammatical because of the bodyguard condition.

- (35) a. * *Oviana*_i *iza*_j *no nanantena* *t_j* *fa nanasa* *lamba Rakoto* *t_i*?
 when who foc pst.AT.hope C pst.AT.wash cloth Rakoto
 ‘Who hoped that Rakoto washed clothes when?’
- b. *Oviana*_i *iza*_j *no nantenain-dRaso* *t_i* *fa nanasa* *lamba* *t_j*?
 when who foc pst.TT.hope.gen.R C pst.AT.wash cloth
 ‘When did Raso hope that who washed clothes?’
- c. *Oviana*_i *iza*_j *no nantenain-dRaso* *fa nanasa* *lamba* *t_j* *t_i*?
 when who foc pst.TT.hope.gen.R C pst.AT.wash cloth
 ‘Who did Raso hope washed clothes when?’

Hence there are only two potential derivations for long-distance adjunct movement. First, the adjunct may be promoted to subject with CT morphology, undergo subject raising and then front (see (8c) and (33)). Second, the adjunct may adjoin to a subject, subsequently raising and fronting together with that subject, as in (35c).

4. Conclusion

Summing up, this paper has examined what look like some unusual properties of Malagasy *wh*-movement. It appears that subjects (and to a lesser degree, adjuncts) have a special status for extraction. Moreover, long-distance A-bar movement is not available. Both of these properties are common within the Austronesian family. (But see Sells (in press) for arguments that all raising in the Philippine languages is A-bar movement.) A third property arises from the bodyguard condition. Malagasy allows two *wh*-elements to be fronted together.

I have suggested that adjuncts may adjoin to subjects to give rise to this configuration. Although multiple fronting is not common in the Austronesian family (I know of no other cases), a similar type of overt amalgamation of *wh*-elements has been proposed for Japanese (Tanaka (1998)). Both languages exploit this strategy for the movement of adjuncts: Malagasy raises the amalgamated elements while Japanese scrambles them. Thus one process can surface in distinct forms in different languages.

References

- Chung, Sandra. 1982. 'Unbounded dependencies in Chamorro grammar', *Linguistic Inquiry* 13: 39-77.
- Cole, Peter and Gabriella Hermon. to appear. 'The typology of *wh* movement: *wh* questions in Malay', *Syntax* 1.
- Davies, William. 1998. Radically local and partial *wh*-movement in Madurese. WECOL 10, Arizona State University. (this volume)
- Georgopoulos, Carol. 1991. *Syntactic variables: Resumptive pronouns and A' binding in Palauan*. Dordrecht: Kluwer.
- Horvath, Julie. 1997. 'The status of '*wh*-expletives' and the partial *wh*-movement construction of Hungarian', *Natural Language and Linguistic Theory* 15: 509-572.
- Huang, C.T. James. 1982. Logical relations in Chinese and the theory of grammar. PhD thesis, Cambridge, MA, MIT.
- Kayne, Richard. 1995. *The antisymmetry of syntax*. Cambridge, MA: MIT Press.
- Keenan, Edward. 1976. Remarkable subjects in Malagasy. In *Subject and topic*, Ed. C. Li: 249-301. New York: Academic Press.
- McDaniel, Dana. 1989. 'Partial and multiple *wh*-movement', *Natural Language and Linguistic Theory* 7: 565-604.
- Paul, Ileana. 1998. Malagasy *wh*-movement. NELS 29, University of Delaware, GLSA.
- Richards, Norvin. 1997. What moves where when in which language? PhD thesis, Cambridge, MA, MIT.
- Rudin, Catherine. 1988. 'On multiple questions and multiple *wh* fronting', *Natural Language and Linguistic Theory* 6: 445-501.
- Sells, Peter. in press. Raising and the order of clausal constituents in the Philippine languages. In *Formal issues in Austronesian linguistics*, Eds. I. Paul, V. Phillips and L. Travis: 105-129. Dordrecht: Kluwer.
- Tanaka, Hidekazu. 1998. Multiple *wh*-questions and the unique spec hypothesis. WECOL 10, Arizona State University. (this volume)
- Ura, Hideki. 1996. Multiple feature checking: A theory of grammatical function splitting. PhD thesis, Cambridge, MA, MIT.

Ileana Paul
 McGill University
 Department of Linguistics
 1001 Sherbrooke West
 Montreal, PQ H3A 1G5
 ipaul@po-box.mcgill.ca

A Syntax for Adverbs

Eric Potsdam

Yale University

In his 1972 monograph *Semantic Interpretation in Generative Grammar*, Ray Jackendoff begins the chapter on adverbs saying, “the adverb is perhaps the least studied and most maligned part of speech. . . . maltreated beyond the call of duty”. Twenty-five years later the analysis of adverbs continues to receive relatively little attention in the linguistic literature (notable exceptions include Ernst 1984, Alexiadou 1994, and Cinque 1998). This is surprising given that adverb placement is extremely widely used as a probe on syntactic structure. Such diagnostics, it has been pointed out however, can be misleading and/or inaccurate, precisely because a comprehensive theory of adverb position is not available (Iatridou 1990, Bobaljik and Jonas 1996, Collins and Thráinsson 1996). This paper is a contribution towards addressing this situation. Using English adverb placement and a conservative conception of English clause structure, it develops a theory of adverb syntax.

The paper is organized as follows. Section 1 proposes a structural description for the distribution S- and VP-adverbs in English, following observations in Jackendoff 1972. Section 2 provides a theoretical basis for the proposal. The fundamental idea is that a given adverb class is structurally licensed by one or more heads in a definable domain. Where in a structure a particular adverb may appear is thus sharply restricted. The analysis accounts for the distribution of Jackendoff’s adverb classes as well as additional classes in English. Section 3 closes with an indication of some further issues for the proposal.

1 Adverb Distribution in English

In this section, I offer a description of the distribution of two major classes of English adverbs. Section 1.1 presents observations from Jackendoff’s (1972) seminal work on adverb placement in English finite clauses. Section 1.2 adapts these generalizations to more recent syntactic structures and proposes an explicit structural distribution. Section 1.3 offers empirical support.

1.1 Adverb Placement: Jackendoff 1972

Jackendoff 1972 develops a classification of adverbs in English based on their positional distribution in tensed clauses. It recognizes two syntactic classes of adverbs corresponding to the traditional distinction between predicate modifiers and propositional modifiers. In Jackendoff's syntactic analysis, the former are attached at the VP level while the latter modify S. For this reason, the two classes are called VP-ADVERBS and S-ADVERBS. Examples of each are given in (1) and (2), respectively (Jackendoff's (3.12) and (3.7)).

- (1) Stanley *completely/easily/handily/quickly* ate his Wheaties.
- (2) Horatio *evidently/probably/certainly/apparently* lost his mind.

The distribution that Jackendoff offers for the two adverb classes is illustrated in (3) through (9). S-adverbs may appear clause-initially, (3); immediately following the subject, (4); or to the immediate right of a modal or finite auxiliary verb, (5).

- (3) a. *Probably* Sam has been called.
b. *Often* Max is climbing the walls of the garden.
- (4) a. Sam *probably* has been called.
b. Max *often* is climbing the walls of the garden.
c. George *apparently* ate the leftovers.
- (5) a. Sam has *probably* been called.
b. George will *certainly* show up late.
c. They were *undoubtedly* ruined by the hurricane.

They may not appear to the right of a non-finite auxiliary, (6).¹

- (6) a. *Sam has been *probably* called.
b. *My phone is being *possibly* bugged.

VP-adverbs, in contrast, may appear clause-finally, in (7), or to the left of the main verb, in (8). This latter position is independent of what might precede the adverb: any combination of modal and/or auxiliaries is permissible, as illustrated.

- (7) a. George won't be reading that book *quickly*.
b. The mouse went through the maze *easily*.

- (8) a. George won't be *quickly* reading that book.
 b. The mouse *easily* went through the maze.
 c. They could have been *safely* rescued.

VP-adverbs are not permitted to the left of modals or auxiliaries. (9).²

- (9) a. *George won't *quickly* be reading that book.
 b. *George *quickly* won't be reading that book.
 c. *They could *safely* have been rescued.

These positional distributions are summarized in (10) and (11).

- (10) *Positional Distribution of S-Adverbs*
 a. clause-initial
 b. immediately following the subject
 c. to the immediate right of a modal or finite auxiliary
- (11) *Positional Distribution of VP-Adverbs*
 a. clause-final
 b. to the immediate left of the main verb

Particularly in light of footnotes 1 and 2, I note that these distributions are idealizations. They are nevertheless useful and otherwise realistic ones and I will adopt them for what follows. A proposal to translate these descriptions into a concrete syntactic analysis is conspicuously absent in the recent linguistic literature. I develop one in the following section.

1.2 A Syntactic Proposal

To develop an analysis of adverb placement, two questions must be answered, 1) how are adverbs integrated into a syntactic structure (subsection 1.2.1) and 2) where are they integrated (subsection 1.2.2). I propose that adverbs are realized in adjunction positions within a conservative clause structure that has a unitary IP dominating one or more VPs.

1.2.1 *how adverbs are realized*

Two options for how adverbs are realized in a structure are that they are in adjoined positions (Pollock 1989, Iatridou 1990, Johnson 1991, Bowers 1993 and others) or that they are in specifier positions (Jackendoff 1981, Alexiadou 1994, Kayne 1994, Cinque 1998 and references therein). This issue is too large to be decided here; I will simply offer two observations that support the adjunction approach that I will adopt. First, adjunction accounts for the possibility of adverb iteration. In general, multiple adverbs may 'pile up' hierarchically at a single location. Examples are given in (12), several from

Ernst 1984. Regardless of the exact structural position of these adverbs, several in one sentence are easily accommodated with adjunction.

- (12) a. Hazel *probably often* goes there.
 b. He *apparently never merely* skims papers but rather reads each one carefully.
 c. The burglars *evidently probably* broke in the back door.
 d. 'He *gladly always* took people up for rides.' (*SF Chronicle*, 4/12/96)
 e. Kim has *now most likely really only* been keeping up with the soap operas.

With adverbs in specifier positions, a distinct projection for each adverb would be required since a projection has exactly one specifier. Consequently, numerous empty heads would necessarily be present and a highly articulated clause structure would be required in order to accommodate the examples in (12). While this would not be impossible, such projections should be accompanied by some English-internal motivation, which is absent.

Second, a characteristic of adjunction is the unordered nature of multiple adjuncts. Although Cinque 1998 has argued in great detail that adverbs within the two classes under investigation are rigidly ordered, this is not always so. When the semantics are appropriate, certain pairs of adverbs may be freely ordered:

- (13) a. The rebels have $\left\{ \begin{array}{l} \text{now perhaps} \\ \text{perhaps now} \end{array} \right\}$ surrendered.
 b. John will $\left\{ \begin{array}{l} \text{probably wisely} \\ \text{wisely probably} \end{array} \right\}$ accept your help.
 c. The children $\left\{ \begin{array}{l} \text{actually usually} \\ \text{usually actually} \end{array} \right\}$ make their own suppers.
 d. All the recipes have been $\left\{ \begin{array}{l} \text{carefully painstakingly} \\ \text{painstakingly carefully} \end{array} \right\}$ tested.

I conclude that adjunction is a plausible approach to integrating adverbs into clausal structure and will adopt it in what follows.

1.2.2 *where adverbs are realized*

I assume that English has the clause structure consisting of a unitary IP dominating VP (Chomsky 1986), as represented by the examples in (14). The specifier of IP is the canonical surface position of the subject.

Regarding the specific lexical content of the verbal and inflectional projections, I follow Chomsky 1957, Emonds 1976, Lobeck 1987 and numerous others in taking the modals, *must*, *can*, *should*, etc., to be lexically specified as being of

category I. Also of category I are forms of support *do*, which I take to be directly inserted into I when needed. Accepting a long tradition dating back to Ross 1969, the auxiliaries *have* and *be* are of category V. When the auxiliaries are tensed, they obligatorily undergo V-to-I head movement, which main verbs do not undergo (Klima 1964, Jackendoff 1972, Emonds 1976, Pollock 1989, Chomsky 1991 and many others). Under these assumptions, the structure of a sentence containing a modal or a finite auxiliary is (14), which illustrates the above assumptions.

(14) a. They (might) have been waiting.

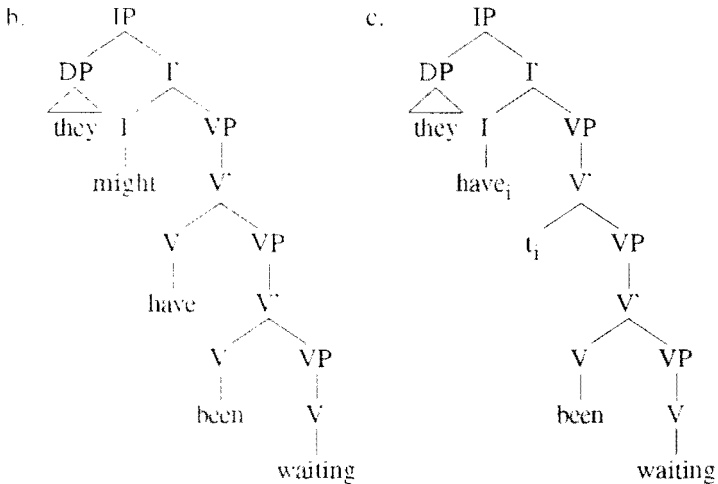

Given that adverbs are adjoined elements, (15) and (16) constitute a proposal that will place adverbs in the linear positions described above.

(15) *Syntactic Distribution of S-Adverbs*

- a. left adjunction to IP
- b. left adjunction to I'
- c. left adjunction to the topmost VP

(16) *Syntactic Distribution of VP-Adverbs*

- a. left or right adjunction to main verb V'

The proposal places adverbs in the positions indicated in (17). The reader can verify that these are just those desired given Jackendoff's description and that, consequently, the proposal captures the word order facts above. The following section demonstrates that the structural claims capture two additional sets of syntactic facts.

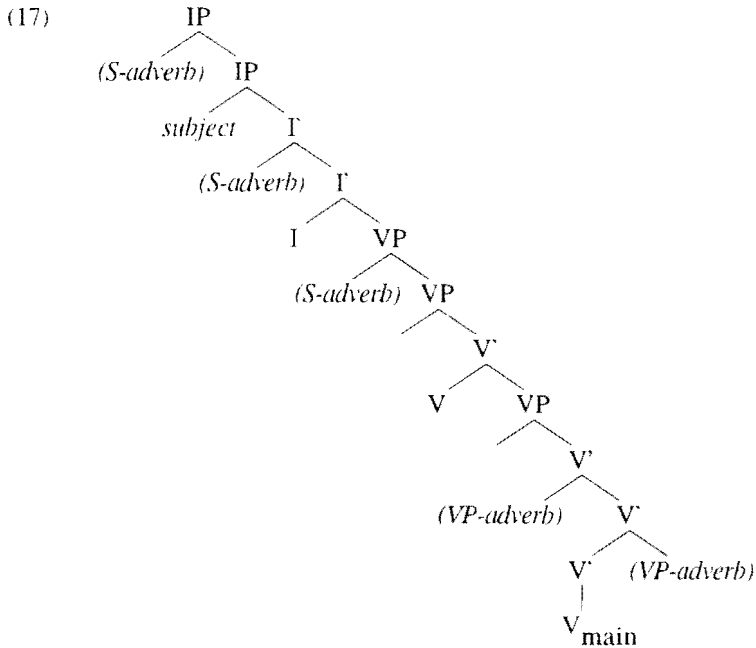

1.3. Syntactic Consequences

Two desirable syntactic consequences follow from the above proposal. First, (18) demonstrates that S-adverbs must always appear to the left of a VP-adverb in the preverbal position. This follows from (15) and (16) because an adjunction to (the topmost) VP will always be above a V' adjunction site.

- (18) a. Hulk Hogan [evidently]_S [completely]_{VP} annihilated his opponent.
 b. *Hulk Hogan [completely]_{VP} [evidently]_S annihilated his opponent.

Second, (19) and (20) illustrate that the two classes of adverbs behave differently with respect to their interpretation in VP ellipsis structures. When there is an empty VP (marked by \emptyset in the examples below) whose interpretation depends upon a VP antecedent which contains a VP-adverb, the VP-adverb must be interpreted in the missing VP, (19). In the case of S-adverbs, this is not necessary. The S-adverb may be included in the interpretation, (20a), but crucially need not be. (20b,c).

- (19) a. Helga easily won her race and Sophie will \emptyset too.
 \emptyset = easily win her race, *win her race

- b. Johnny blatantly disobeys the baby sitter because his sister does \emptyset .
 \emptyset = blatantly disobeys the baby sitter, *disobeys the baby sitter
 - c. Daisy thoroughly cleaned the pans since the automatic dishwasher couldn't \emptyset .
 \emptyset = thoroughly clean the pans. *clean the pans
- (20)
- a. No logician would knowingly state a falsehood even though a politician might \emptyset .
 \emptyset = state a falsehood, knowingly state a falsehood
 - b. Due to the traffic, we will unfortunately miss the opening credits, but those who were there early won't \emptyset .
 \emptyset = miss the opening credits. *unfortunately miss the opening credits
 - c. The Mafia allegedly set the hotel on fire since the owner wouldn't \emptyset .
 \emptyset = set the hotel on fire. *allegedly set the hotel on fire

These examples are accounted for under the assumptions that VP ellipsis targets VPs and that an S-adverb adjoined to VP creates a two segment category, either of which is a possible antecedent for VP ellipsis. Adjunction to V' in the case of VP-adverbs does not create a structurally ambiguous antecedent. There is only one VP that can be the antecedent and the VP-adverb is necessarily internal to it. It is worth pointing out that both sets of facts, without additional assumptions, would seem to rule out adjoining VP-adverbs to VP instead of V'.

Section 2 to follow attempts to demonstrate that, despite appearances, the distributional patterns in (15) and (16) also have theoretical support. It presents a theoretical foundation to the above distributional patterns. The fundamental analytical claim is that adverbs are licensed by lexical heads in some local domain. This licensing restricts where adverbs may appear and accounts for their realized structural positions.

2 Adverb Licensing

A primary desideratum for any syntactic proposal regarding adverb placement is that it reflect the apparent link between what an adverb modifies and its syntactic position. This goal is a specific instantiation of what Sportiche 1988 formulates as the Adjunct Projection Condition. (21).

- (21) *Adjunct Projection Condition* (Sportiche 1988)
 If some semantic type X modifies some semantic type Y , and X and Y are syntactically realized as x and y , x is projected adjacent to either y or the head of y .

Sportiche's proposal, while intuitively desirable, is programmatic in the sense that it does not specify what the actual syntactic realization(s) of the semantic

modification are. This would hinge largely on the interpretation of “adjacent” in (21). The above proposal stipulates what these realizations are for adverbs but is compatible with Sportiche’s claim that it is the head of a modified element that plays a central role in the actual syntactic outcome. If we look more closely at the set of adjunction sites for S- and VP-adverbs, (22a,b), we see that each class clusters around a particular head, I' or main verb V' , respectively.

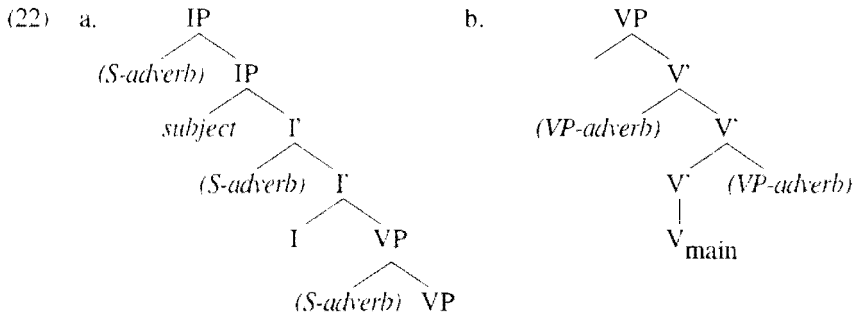

Accepting that such groupings have some validity, I will develop the hypothesis that the two adverb types are actually licensed in their syntactic positions by the respective heads (see Roberts 1986, Travis 1988, and Alexiadou 1994 for similar proposals and Bowers 1993 for an application of the idea). Adverbs are licensed by a head and must occur in a position that is syntactically associated with the head via some relation, call it R. I will formulate R as “in the government domain of”.^{3,4} Informally, a head H' ’s government domain includes its specifier, phrases adjoined within its projection to H' , and those adjoined to the complement of H' . We may say, then, that S-adverbs/VP-adverbs must modify IP/VP within the government domain of the head I'/V' , as generalized in (23). Below I evaluate the success of this proposal with respect to the distribution of VP- and S-adverbs developed earlier.

- (23) *Adverb Licensing Proposal*
 Adverb classes are licensed by X' heads and must be structurally realized in the government domain of the head

2.1 VP-Adverb Licensing

The analysis correctly predicts the adjunction possibilities for VP-adverbs repeated in (16).

- (16) *Syntactic Distribution of VP-Adverbs*
 a. left or right adjunction to main verb V'

Adjunction to V' is within the government domain of V' . The arguments above indicated that VP-adverbs should not be adjoined as high as VP and, indeed, adjunction to VP is not a position in the government domain of V' , as desired. Exactly the configurations encoded in the structure in (22b) fall out. Although a VP-adverb adjoined to the complement of V' would also be in the government domain, such a structure is ruled out by the Adjunction Prohibition (Chomsky 1986, McCloskey 1992), which disallows adjunction to arguments of a lexical head—phrases that are s(emantically)-selected. It only permits adjunction to complements of functional heads, which are not s-selected.

2.2 S-Adverb Licensing

Now consider the distribution of S-adverbs in (15).

- (15) *Syntactic Distribution of S-Adverbs*
- a. left adjunction to IP
 - b. left adjunction to I'
 - c. left adjunction to the topmost VP

An adverb adjoined to the VP selected by I' will be in the government domain of I' . This accounts for (15c), which previously seemed like a rather odd restriction since reference to the 'topmost' VP is otherwise *ad hoc*. An adverb adjoined to I' , in (15b), is also transparently in the government domain of I' . An additional position in the government domain of I' not considered above is right adjunction in general. The adverb licensing proposal predicts that S-adverbs should adjoin on the right as well as the left, as was the case with VP-adverbs. This is in fact permitted. Typically there is a pause required before the adverb, (24). Thus the prediction is realized, although details remain to be understood.⁵

- (24) a. Horatio has lost his mind, *probably*.
 b. Casey thinks that there are guerrillas in the rose garden, *evidently*.
 c. Louis had rid the city of rats, *supposedly*.
 d. They'll win *most likely*.

The remaining IP-adjoined position, (15a), however, is incorrectly ruled out. The proposal does not permit S-adverb adjunction to IP since an adverb in such a position would not be in the government domain of I' . We have already seen that this is the correct result for V' and VP-adverbs. Without modifying the definition of government, two options are available: 1) the IP-adjoined site is not a base-generated adverb position and an adverb that appears there is licensed elsewhere in the structure and moves to the IP-adjoined position or 2) an adverb in the IP-adjoined position is base-generated there and is licensed by some higher

head. In the present context, the latter alternative is the more interesting one and I explore it in the following section.

2.3 Licensing from C°

Given the structure in (25), it is clear that an adverb adjoined to IP will be in the government domain of C° just as an adverb adjoined to VP was in the government domain of I°. This provides a mechanical way of licensing IP-adjoined adverbs in the examples repeated in (3).

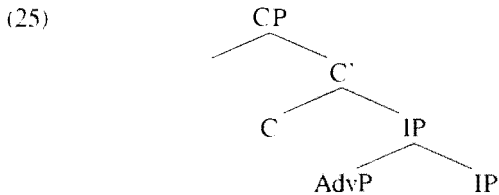

- (3) a. *Probably* Sam has been called.
 b. *Often* Max is climbing the walls of the garden.

Licensing clause-initial adverbs from C° leads to two expectations. First, since there are other positions in the government domain of C°, we expect to find adverbs in these positions as well—in particular, left adjunction to C°. Second, since I° and C° are distinct licensers, there is the possibility that an adverb will be licensed by only one of the two heads. Such an adverb, if licensed by I° but not C°, could appear immediately following the subject but not clause-initially. Both of these expectations seem to be borne out and are illustrated below.

The examples in (26) confirm the possibility of C°-adjoined adverbs. I assume that questions are CPs with the *wh*-phrase in the specifier of CP and the inverted auxiliary in C°. With reference to the structure in (25), C° adjunction places an adverb between these two elements as illustrated for (26d).

- (26) a. Who *possibly* can we call at this hour of the night?
 b. Which of them *apparently* does he not like?
 c. Where *conceivably* could one find a good buy on snow tires?
 d. [_{CP} where [_{C°} *most likely* [_{C°} will [_{IP} the spy meet his contact?]]]]

The second expectation is that there will exist classes of adverbs which are licensed by only one of either I° or C°. In addition to S- and VP-adverbs, Jackendoff 1972 describes a third class of adverbs which have the positional distribution of neither of the former two classes. Adverbs like *merely*, *hardly*, or *scarcely* do not fall into either class on syntactic or semantic grounds. I will call them E(XTENT)-ADVERBS since they approximately describe the extent or degree

to which a situation holds. Jackendoff gives their distribution as necessarily occurring somewhere between the subject and the main verb. (27) shows the immediate post-subject and post-modal positions. (28) illustrates that they may also appear to the right of a non-finite auxiliary. The clause-initial position is not possible. (29). As Jackendoff observes, only clause-internal positions are acceptable for E-adverbs.

- (27) a. He (*simply*) is (*simply*) incapable of it.
 b. The raccoons (*scarcely*) have (*scarcely*) touched our garbage.
 c. They (*hardly*) should (*hardly*) worry about that.
- (28) a. They must have *simply* gotten lost.
 b. John will have *merely* been beaten by Bill.
 c. They should have *hardly* worried about that.
- (29) a. **Simply* he is incapable of it.
 b. **Scarcely* the raccoons have touched our garbage.
 c. **Hardly* they should worry about that.

(30) extends the description of adverb placement the clause-internal positioning of E-adverbs. It places them in any of the positions in (31). The structure shown is for (27c).

- (30) *Syntactic Distribution of E-Adverbs*
 a. left adjunction to I'
 b. left adjunction to VP or V'

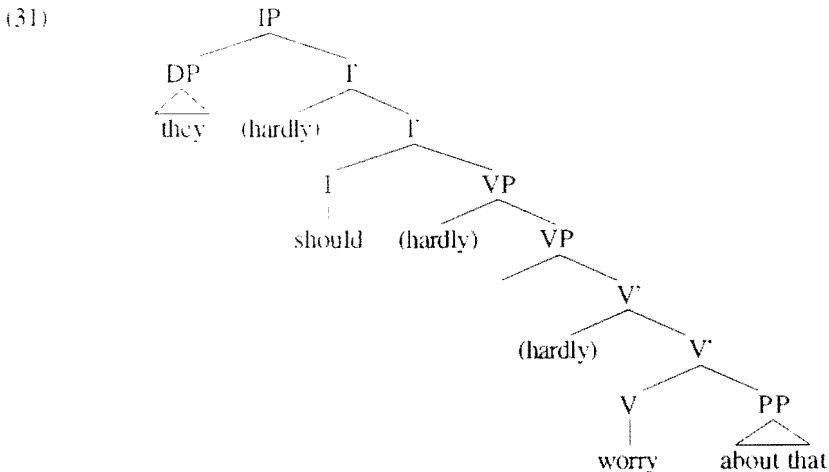

(30) is a statement of the distribution of E-adverbs. It can be captured by allowing E-adverbs to be licensed by I' and V', but not C'. I' licensing will permit E-adverbs adjoined to I' and the topmost VP. V' licensing allows the adverb to adjoin to V' and to a VP that is the complement of some V'. These possibilities are seen in the structure in (31) and are exactly those proposed in (30), permitting only the data in (27) and (28).⁶ Crucially, the clause-initial position, (29), and the C'-adjoined position, illustrated by the ungrammatical examples in (32), are ruled out. These are the positions that would be licensed by C'. Such an analysis thus supports the idea that I' and C' are distinct licensing options.

- (32) a. *Who *simply* will he not invite?
 b. *Why *hardly* did Zoe talk to you?
 c. *What *just* didn't the students understand?

3 Conclusions

In this paper, I have investigated the syntactic distribution of several adverb classes in English and proposed an analytical basis for their realizations. The core of the proposal is the Adverb Licensing Hypothesis repeated in (23).

- (23) *Adverb Licensing Proposal*
 Adverb classes are licensed by X' heads and must be structurally realized in the government domain of the head

The results can be summarized by the table in (33). Individual adverb classes are licensed by a subset of the heads found in a canonical English clause.

(33) *The Distribution of Some English Adverb Classes*

<u>CLASS</u>	<u>LICENSER</u>
S-adverbs	C', I'
VP-adverbs	main V'
E-adverbs	I', V'

Assuming that the proposal has some validity, two questions immediately arise. First, can the heads that license a particular class of adverbs can be determined from the meaning of the adverb? In other words, is there a relationship between an adverb's licensing head(s) and its interpretation? If so, the system would be maximally simple: the distribution of an adverb would be fully determined by its meaning and the Adverb Licensing Proposal. Work to date on the semantics of adverbs, however, has indicated that, if there is a mapping between the syntax and semantics of adverbs, it is rather complex. The desired reduction may not in fact be possible.

Second, more general considerations lead one to ask how the proposal extends cross-linguistically. Other languages are argued to have both different adverb distributions and clause structure. How does the proposal apply to articulated Infl structures (Pollock 1989, Chomsky 1991, Bobaljik and Jonas 1996, and others)? With the introduction of additional heads, the licensing possibilities multiply. This may or may not be a desirable consequence. Additional work beyond this initial investigation is required.

Although the relative position of adverbs with respect to other elements in a clause is often used as a diagnostic on clause structure, such accounts are rarely explicit as to what the assumptions regarding adverb syntax are that allow the diagnostics to succeed. By developing and defending a unified account of adverb placement, we can use adverb position as a reliable probe on syntactic structure, including verb movement, subject positions, the placement of displaced constituents, and other central word order phenomena.⁷

Notes

I would like to thank Judith Aissen; Chris Kennedy; Jim McCloskey; participants in my 1996 Fall syntax seminar at UCSD; and audiences at UCSD, Swarthmore College, and WECOL98 (Arizona State University) for some excellent examples, interesting predictions, and thought-provoking discussions of this work. Potsdam 1998 contains a more extensive investigation of this proposal.

¹Erast 1984 argues that S-adverb interpretations are not restricted as Jackendoff 1972 claims and that, in addition to the above, they may also be found after multiple auxiliaries. Some of his examples in (i) do seem acceptable. It is unclear why examples such as (i) are so infrequent or difficult to create. In general, S-adverbs do not sound grammatical when they are as far right as in (i)—as Jackendoff originally maintained and as I will idealize here.

- (i) a. The library staff has been *stupidly* filing all those articles on Raising in the child psychology section.
 b. Egbert might have been *cleverly* abducted to get an interview with the guerrillas.
 c. She may have *actually* been only aiming for the vice-president's job.

²Again, Ernst's (1984) proposal is less restrictive. In addition to permitting VP-adverbs next to the main verb, it allows them to the left of the passive auxiliary, as in (i). I will ignore this in the formulation above.

- (i) Bobby will have *handily* been beaten by Billy Jean.

³A fully equivalent proposal can be developed taking R to be "in the checking domain of" (Chomsky 1993).

⁴I assume the definition of government from Rizzi 1990:

- (i) *Head Government* (Rizzi 1990:6)
 X head governs Y iff
 a. X = {A, N, P, V, I, C}
 b. X m-commands Y
 c. no barrier intervenes
 d. Relativized Minimality is respected

⁵In general, adverb positioning does not seem to be completely symmetric with respect to left and right adjunction possibilities, as the proposal would lead one to expect. Several alternatives might be pursued. Much work has suggested that government is sensitive to direction and directionality effects might be factored into the proposal. Alternatively, Kayne 1994 proposes that all right adjunction is prohibited. Under such an assumption, apparent cases of right-adjoined adverbs would require reanalysis (see Bowers 1993, Costa 1996). Lastly, discourse considerations might influence the choice of right versus left adjunction. In particular, if the right adjoined position has certain discourse properties which are largely incompatible with the use of a particular adverb, then the dispreference for the right-adjoined position might be accounted for.

⁶The proposal does not prevent right adjunction of E-adverbs, which must transparently be prohibited so that these adverbs do not appear clause finally. I have no explanation for this restriction. See the previous footnote.

⁷See Potsdam 1998 for an application of this system of adverb placement to the investigation of the syntax of less-well-studied imperatives and subjunctive complement clauses in English. The results obtained, using the proposed adverb distributions as a probe on clause structure, converge with those determined by independent diagnostics. That work thus provides further support for the general approach taken here.

References

- Alexiadou, Artemis. 1994. "Issues in the Syntax of Adverbs". University of Potsdam Ph.D. dissertation.
- Bobaljik, Jonathan David and Diane Jonas. 1996. "Subject Positions and the Roles of TP". *Linguistic Inquiry* 27:195-236.
- Bowers, John. 1993. "The Syntax of Predication". *Linguistic Inquiry* 24:591-656.
- Chomsky, Noam. 1957. *Syntactic Structures*. The Hague: Mouton.
- Chomsky, Noam. 1986. *Barriers*. Cambridge, Ma.: MIT Press.
- Chomsky, Noam. 1991. "Some Notes on Economy of Derivation and Representation", in Freidin, Robert (ed.), *Principles and Parameters in Comparative Grammar*. Cambridge, Ma.: MIT Press.
- Chomsky, Noam. 1993. "A Minimalist Program for Linguistic Theory". in Hale, Kenneth and Samuel J. Keyser (eds.), *The View from Building 20*. Cambridge, Ma.: MIT Press. 1-52.
- Cinque, Guglielmo. 1998. *Adverbs and Functional Heads: A Cross-Linguistic Perspective*. Oxford: Oxford University Press.
- Collins, Chris and Höskuldur Thráinsson. 1996. "VP-Internal Structure and Object Shift in Icelandic". *Linguistic Inquiry* 27:391-444.

- Costa, João. 1996. "Adverb Positioning and V-Movement in English: Some More Evidence". *Studia Linguistica* 50:22-34.
- Emonds, Joseph E. 1976. *A Transformational Approach to English Syntax*. New York: Academic Press.
- Ernst, Thomas. 1984. *Towards an Integrated Theory of Adverb Position in English*. Bloomington, Indiana: Indiana University Linguistics Club.
- Iatridou, Sabine. 1990. About Agr(P). *Linguistic Inquiry* 21:551-577.
- Jackendoff, Ray. 1972. *Semantic Interpretation in Generative Grammar*. Cambridge: MIT Press.
- Jackendoff, Ray. 1981. *Xbar Syntax: A Study of Phrase Structure*. Cambridge, Ma.: MIT Press.
- Johnson, Kyle. 1991. "Object Positions". *Natural Language and Linguistic Theory* 9:577-636.
- Kayne, Richard S. 1994. *The Antisymmetry of Syntax*. Cambridge, Ma.: MIT Press.
- Klima, Edward S. 1964. "Negation in English". in Fodor, Jerry A. and Jerrold J. Katz (eds.). *The Structure of Language: Readings in the Philosophy of Language*. New Jersey: Prentice-Hall, Inc.
- Lobeck, Anne. 1987. "Syntactic Constraints on VP Ellipsis". University of Washington Ph.D. dissertation.
- McCloskey, James. 1992. "Adjunction, Selection, and Embedded Verb Second". LRC-92-07. Linguistics Research Center, University of California, Santa Cruz.
- Pollock, Jean-Yves. 1989. "Verb Movement, Universal Grammar, and the Structure of IP". *Linguistic Inquiry* 20:365-424.
- Potsdam, Eric. 1998. *Syntactic Issues in the English Imperative*. New York: Garland Publishing Company.
- Rizzi, Luigi. 1990. *Relativized Minimality*. Cambridge, Ma.: MIT Press.
- Roberts, Ian. 1986. *The Representation of Implicit and Dethematized Subjects*. Dordrecht: Foris.
- Ross, John Robert. 1969. "Auxiliaries as Main Verbs". *Studies in Philosophical Linguistics* 1:77-102.
- Sportiche, Dominique. 1988. "A Theory of Floating Quantifiers and Its Corollaries for Constituent Structure". *Linguistic Inquiry* 19:425-449.
- Travis, Lisa. 1988. "The Syntax of Adverbs". in *McGill Working Papers in Linguistics: Special Issue on Comparative German Syntax*. Montreal: McGill University. 280-310.

Eric Potsdam
Department of Linguistics
P.O. Box 208236
Yale University
New Haven, CT 06520
eric.potsdam@yale.edu

Root Infinitives in Agrammatic Speech: Dissociated Functional Projections

Esterella de Roo

Holland Institute of Generative Linguistics

1 Introduction

The internal structure of the nominal and verbal domain is claimed to be highly parallel. Abney (1987) introduced functional projections in the nominal domain. He claims that determiners and pronouns in English head a functional projection, the Determiner Phrase (DP), which dominates the lexical projection NP. Also quantifiers head their own projection, the Quantifier Phrase (QP), according to Abney. The DP hypothesis is adopted for many languages (cf. Ritter 1991 for Hebrew, Barbiers 1992 and Bennis, Corver & Den Dikken 1998 for Dutch, Szabolsci 1994 for Hungarian). In addition to DP and QP, other functional projections are proposed for the nominal domain as well. One of these projections is the Number Phrase (cf. Ritter 1991). I will not discuss the structure of the nominal domain in detail in this paper. Instead, I note that structural parallelism between the domains enables a unified syntactic account of phenomena associated with corresponding functional projections in the nominal and verbal domain. Such an account is presented in Hoekstra & Hyams (1995) and Hoekstra, Hyams & Becker (1996) to explain the co-occurrence between root infinitives (RIs), null subjects and missing determiners in child language. They propose an underspecified Number projection at the RI-stage in child language.

In section 2, I discuss the proposals for child language. In section 3, I introduce another type of speech, agrammatic speech (3.1). In general, agrammatic speech shows the same co-occurrence of RIs, null subjects and missing determiners (3.2). In the remainder of this paper (3.3), I discuss the case of the Dutch agrammatic patient GS. Her speech shows a dissociation between the nominal and verbal domain (3.3.2). Although she produces

many RIs, her speech does not support Hoekstra, Hyams & Becker's (1996) account. In section 3.3.3, I present an alternative account of RIs in agrammatic speech. Section 4 includes the summary and concluding remarks.

2 Child Language: Underspecified Number Projections

Hoekstra & Hyams (1995) propose the structures in (1) for the nominal and verbal domain respectively.

- (1) a. D NUM [_{XP} X [_{NP} N]]
 b. C NUM [_{TP} T [_{VP} V]]

In these structures, determiners parallel complementizers. Both domains include a Number projection. X is the nominal counterpart of T; the exact nature of X is still left open. Hoekstra & Hyams assume that at the RI-stage in child language the Number projection is underspecified. In English and Dutch, when verbal Number is left unspecified, there is no finite morphology available, and hence, the infinitive surfaces. When nominal Number is unspecified, no determiners or pronouns can surface, and plural nouns cannot surface either.

In a follow-up study, Hoekstra, Hyams & Becker (1996) take one further step: underspecification of nominal and verbal Number does not only occur at the same time, but one causes the other. They claim that the emergence of a RI (that is, underspecification in the verbal domain) results from underspecification in the nominal domain. This works as follows. Usually, the verbal Number projection is checked by a nominal phrase, which functions as the subject, in its specifier position. However, if this nominal phrase includes an underspecified Number, it cannot check the verbal Number projection. Therefore, such underspecified (non-finite) subjects only combine with verb forms that are not specified for Number either, that is, with infinitives. So, null subjects, determinerless subjects and RIs co-occur.

It should be stressed that Hoekstra, Hyams and Becker's (1996) account is restricted to non-finite subjects and that they do not discuss the relation between objects and RIs. However, their account is based on a general impairment of the nominal Number projection. This is a DP internal problem, irrespective of the syntactic function of the nominal phrase. Such impairment should effect subjects and objects (and any other nominal

phrases) in the same way. Therefore, I claim that the account of Hoekstra, Hyams & Becker also predicts the occurrence of null objects and determinerless objects at the root-infinitive stage.

3 Agrammatic Speech

3.1 Introduction

Similar to child language, agrammatic speech of Broca's aphasics shows deviant functional structures. Agrammatism is a language disorder associated with Broca's aphasia. It covers both language production and language comprehension, but I only discuss agrammatic speech in this paper. The main characteristic of agrammatic speech is the omission and/or substitution of what traditionally have been called grammatical morphemes. Both freestanding morphemes, including determiners and pronouns, and bound morphemes, including finite verb inflection, are affected. Translated into current linguistic terms, we might say that agrammatic speech shows an impairment of functional structure, since the categories that head functional projections are impaired. Ouhalla (1993) claims that all functional structure is missing in agrammatic speech. Only recently it has been argued that not all functional projections are equally impaired in agrammatic speech. McEntee (1993) and Hagiwara (1995) showed that only the higher functional projections of both the nominal and verbal domain were impaired in the speech of English and Japanese agrammatic patients respectively. Friedmann & Grodzinsky (1997) showed a dissociation between verbal Tense and Agreement in the speech of a Hebrew patient. So, dissociations seem to occur between higher and lower projections within the nominal and verbal domain: higher projections are impaired while lower projections are intact. Dissociations between the domains have not been reported yet.

3.2 Child language and agrammatic speech

There is a general similarity between child language and agrammatic speech: both types of speech show impaired functional structures. But there are also more specific similarities. First, just as in child language, root infinitives occur in agrammatic speech. Second, just as in child language, omission of finiteness seems to co-occur with omission of determiners and pronouns. Consider the examples in (2).

- | | | |
|-----|-----------------------------------|--|
| (2) | <u>child language</u> | <u>agrammatic speech</u> |
| a. | thee drinken
'tea drink-inf' | thee zetten
'tea make-inf' |
| b. | popje vallen
'doll fall-inf' | meisje lachen
'girl laugh-inf' |
| c. | ik ook lezen
'I also read-inf' | ik toestel zoeken
'I television look-for-inf' |

The examples from child language are produced by Dutch children at the age between 2 and 3 years old; the examples of agrammatic speech are produced by adult Dutch Broca's patients. The examples in (2a) involve a null subject, (2b) shows a determinerless subject, while in (2c) a pronoun subject is present.

For agrammatic speech, no specific accounts for the emergence of RIs and their co-occurrence with pronoun and determiner omission are available. There are three logical possibilities to explain the co-occurrence in terms of impaired functional structures, as shown in (3).

both domains are equally impaired
impairment nominal domain affects realization verbal domain
impairment verbal domain affects realization nominal domain

(3) co-occurrence of RIs, pronoun and determiner omission

The first possibility is found in Hoekstra & Hyams (1995) for child language and Ouhalla (1993) for agrammatic speech. The second possibility is proposed in Hoekstra, Hyams & Becker (1996).

In the remainder of this paper, I discuss the case of the Dutch agrammatic patient GS (cf. De Roo 1997). She produces many RIs; these RIs include null subjects but full DP objects. I will present an account of agrammatic speech which covers the speech of patient GS.

3.3 The case of patient GS

3.3.1 Patient and method

GS is a female Dutch agrammatic patient. She was 47 when she had a CVA,

a cerebro vascular accident, also called a stroke, which resulted, among other problems, in a Broca's aphasia. GS was tested five times, over a period of 5.5 years. Her speech does not show any recovery with respect to syntax. I studied her spontaneous speech, collected by means of two different tests. First, the spontaneous speech interview of the Aachen Aphasia Test (Graetz et al. 1992). In this interview, patients answer general questions, such as 'how did your aphasia started, how are you doing right now, can you tell me something about your (former) job, your family, your hobbies'. Second, the ANELT test (Blomert et al. 1995). This test measures the verbal communicative abilities of aphasic patients. Patients are presented with a daily life situation and then asked what they would say in such a situation. Examples of these situations are 'inviting your neighbour for coffee' or 'go to the shoemaker to get your shoe repaired'.

3.3.2 *Root infinitives and null subjects*

The distribution of utterance types in the speech of patient GS is shown in the table in (4).

non-verbal utt 291 (57%)	non-finite utt 180 (35%)	finite sentences 43 (8%)
-----------------------------	-----------------------------	-----------------------------

(4) distribution of utterance types in spontaneous speech

The vast majority of GS's utterances do not contain a verb. Her verbal utterances can be subdivided as shown in the table in (5).

infinitival clauses 6 (3%)	root infinitives 118 (53%)	root participles 56 (25%)	finite sentences 43 (19%)
----------------------------------	----------------------------------	---------------------------------	---------------------------------

(5) distribution of verbal utterance types in spontaneous speech

The vast majority of verbal utterances are root infinitives. I will not go into the question whether root participles should be analysed similar to or different from RIs¹. I restrict myself to RIs in this paper. The distribution of subjects and objects in RIs and finite sentences is shown in the tables in (6) and (7). In RIs subjects are generally missing, while objects are usually present. These objects are fully articulated DP structures. Determiner omission does not show up (except for one case). In finite sentences both subjects and objects are usually present. The majority of these subjects and

objects is expressed as fully articulated DPs. There is no determiner omission.

RIs	null pronoun	determinerless	full DP
subjects	112 (95%)	0 (0%)	6 (5%)
objects	16 (27%)	1 (2%)	43 (71%)

(6) distribution of subjects and objects in RIs

finite utt	null pronoun	determinerless	full DP
subjects	5 (12%)	0 (0%)	38 (88%)
objects	2 (7%)	0 (0%)	26 (93%)

(7) distribution of subjects and objects in finite sentences

The tables (6) and (7) do not show evidence for a general impairment in the nominal domain. All, but one, obligatory determiners are correctly realized. These determiners include definite and indefinite articles, possessive and demonstrative pronouns, quantifiers and numerals. Some examples are given in (8).

- (8) **de** telefoon **een** keer aannemen
 'the phone a time answer-inf'
de moeder is overleden met **mijn** verjaardag
 'the mother has died at my birthday'
allemaal mensen altijd komen
 'many people always come-inf'

GS also produces many plural nouns, and adjectival agreement² (which involves the nominal features [definiteness], [number] and [gender]) is almost always correct. See some examples in (9).

- (9) a. de boeken lezen
 'the books read-inf'
 weer woordjes leren
 'again words learn-inf'

- b. een ander \emptyset nummer bellen
 'a different number call-inf'
 een andere afspraak maken
 'a different appointment make-inf'

The tables in (6) and (7) only include nominal phrases which function as arguments. However, also adjuncts and nominal phrases in non-verbal utterances contain many determiners and do hardly show determiner omission. The same holds true for finite sentences.

In sum. The speech of GS does not show evidence for a general impairment in the nominal domain: determiners are not omitted, pronouns are only omitted in a specific context, namely the subject position of RIs.

Let us return now to the logical possibilities to explain the emergence of RIs, which were shown in the table in (3). Notice that the speech of GS only shows a partial co-occurrence: RIs co-occur with pronoun omission, but not with determiner omission.

In the speech of GS, the nominal and verbal domain are not equally impaired. The verbal domain is severely impaired: only 8% of GS's utterances are finite sentences. However, no general impairment of the nominal domain was found. The emergence of RIs in the speech of GS is not due to an overall absence of functional structure.

This also rules out the second possible explanation, since the nominal domain is not impaired. I therefore conclude that the theory of Hoekstra, Hyams & Becker (1996) cannot explain the emergence of RIs in the speech of the agrammatic patient GS. It is not the presence of fully articulated DP objects in RIs per se which is ruled out by their theory. It is the fact that impaired nominal phrases are only found in one specific context, the subject position of RIs. I therefore assume that not the nominal phrases themselves are the problem, but that this context poses a problem for the realization of nominal phrases.

Only the third type of explanation is left. A problem in the verbal structure has its effect on the realization of nominal structures. An account of RIs along these lines is presented in the next section.

3.3.3 *An underspecified Tense projection*

The RIs produced by GS involve both time adverbials and negation. See the examples in (10) and (11).

- (10) morgen/vrijdag weer werken
 'tomorrow/friday again work-inf'
 hier nu wonen
 'here now live-inf'
- (11) hier niet voetballen
 'here not play-inf football'
 niet meer blaffen
 'not any longer bark-inf'

The examples in (10) include the time adverbials 'tomorrow', 'friday' and 'now'. The examples in (11) show negation in RIs. I conclude that a Tense Phrase is present in the RIs, since time adverbials and negation should be licensed by TP (cf. Zanuttini 1991, Bobaljik & Jonas 1996). Although TP is present, tense is not overtly realized on the verb. I assume that Tense is underspecified and contains an empty element. This underspecification is not due to specific syntactic or cognitive problems, but it is an attempt to reduce the processing load of the utterance. The empty Tense element does not have inherent features, but is licensed by means of discourse interpretation. I therefore predict that its occurrence is not restricted to any particular context; it should show up in both present and past contexts. The examples in (12) show that this prediction is borne out. The ANELT scenario in (12a) clearly introduces a present tense context, which is overtly expressed by means of the time adverbial *right now*. The question in (12b) clearly refers to the past; it is introduced by the adverbial phrase *it is already a long time ago*.

- (12)a. You have to arrange dinner for a wedding. **Right now** you are in a restaurant. I am the owner. What do you say?

voor twintig personen reserveren
 'for twenty people book-inf'
 eten met z'n allen
 'eat-inf with all of us'

- b. **It is already a long time ago**, but can you tell me once again how your disease started?

werken
 'work-inf'
 op bed nog 't haar even doen
 'on the bed still the hair do-inf'
 thee en ineens een bloeding
 'tea and suddenly a stroke'
 op bed zitten
 'on the bed sit-inf'
 wachten op hulp
 'wait-inf for help'

Both in the present tense context in (12a) and in the past tense context in (12b), GS produces RIs. The empty Tense element in RIs receives a discourse interpretation. Discourse interpretation is only available in the root, the highest projection of the structure, since this is the only position which is not potentially governed by any clause internal antecedent (cf. Rizzi 1994). I assume the CP level to be missing in RIs in agrammatic speech. I further assume that the underspecified Tense cannot assign nominative case. Therefore, subjects are generally missing in RIs; 95% of the subjects are null pronouns³⁴.

Occasionally, subjects are present; 5% of the subjects in RIs are fully articulated DPs. The examples in (13) show that subjects in RIs are moved out of VP.

- (13)a. 't kind eventjes wat krijgen
 'the child just something get-inf'
 b. de hond niet meer blaffen
 'the dog no longer bark-inf'

The subject in (13a) precedes the sentence adverb *eventjes*, while the subject in (13b) precedes negation. These subjects receive a default case in an adjoined position. In Dutch, default case is nominative. I believe default case to be a last resort strategy: it is only invoked when there is no other possibility. In spontaneous speech, many subjects refer to either the speaker or the hearer. This is especially true for the AAT interview and the ANELT test. Since the antecedent is easily recoverable, a null subject is pragmatically allowed in the spontaneous speech of patient GS. A null subject is even preferred, since it dismisses the need to invoke the default strategy. This line of reasoning implies that if the presence of a subject is pragmatically enforced no null subjects will show up. The plausibility of this

implication can be illustrated by means of another test, a picture description test. GS was shown ten pictures in which one or two people perform an action or are involved in a specific situation. She was asked to describe the picture in one sentence. The distribution of utterance types in the picture description test is shown in table (14).

non-verbal utt 4 (40%)	non-finite utt = RIs 5 (50%)	finite sentences 1 (10%)
---------------------------	---------------------------------	-----------------------------

(14) distribution of utterance types in picture description

The distribution in (14) is comparable to the distribution of utterance types in the spontaneous speech in table (4). In the picture description test, all non-finite utterances are RIs. Some examples are given in (15).

- (15) de vrouw koffie zetten in een kan
 'the woman coffee make-inf in a jug'
 de man de krant lezen
 'the man the newspaper read-inf'

The number of null subjects, however, is much lower than in spontaneous speech. See the table in (16) and compare to table (6).

null pronouns 1 (20%)	determinerless 0 (0%)	full DPs 4 (80%)
--------------------------	--------------------------	---------------------

(16) subject types in RIs in picture description

Leaving out the subject is not pragmatically correct while describing a picture. Therefore, the majority of RIs in the picture description test contain a subject. Since the use of a null subject is not a pragmatically correct possibility, the last resort default strategy is invoked.

4 Summary and Concluding Remarks

Possible explanations for the emergence of RIs and their co-occurrence with

pronoun and determiner omission were evaluated on basis of the speech of a Dutch agrammatic patient GS. The speech of GS only shows a partial co-occurrence: her RIs involve pronoun omission but no determiner omission. In general, the nominal domain is intact in the speech of GS. Therefore, any explanation which assumes an impairment in the nominal domain is ruled out. Alternatively, I assume that RIs in agrammatic speech involve, and result from, an underspecified Tense projection. As a consequence, no structural nominative is available; a default nominative can be assigned as a last resort to a subject in an adjoined position. The ingredients of this account of RIs can be found in the literature; see for example the work of Ferdinand (1996), Haegeman (1996) and Bennis, Beukema & Den Dikken (1997) for child language and the work of Friedmann & Grodzinsky (1997) for agrammatic speech.

The observed dissociation between the nominal and verbal domain has not been reported before. It is not yet clear how frequent this pattern is in agrammatic speech. In a group of fifteen Broca's patients, two more patients showed this pattern, in addition to GS (cf. De Roo, in prep). The inverse dissociation - an impaired nominal domain with an intact verbal domain - was not attested. Hoekstra, Hyams & Becker (1996) would theoretically rule out such an inverse dissociation, but the account presented in this paper does not. More empirical data are needed to draw a firm conclusion in this matter.

Notes

1. There is no obvious syntactic reason to exclude root participles from the account I propose for root infinitives in section 3.3.3: the assumption of an underspecified Tense projection seems to be plausible for root participles as well. And there are no empirical differences between root infinitives and root participles with respect to the distribution of subjects and objects in the speech of patient GS. Lasser (1997) distinguishes between root infinitives and root participles on semantic/pragmatic grounds. She states that root infinitives in normal adult language can only refer to non-completed events, while root participles can only refer to completed events.

2. In Dutch, inflection on prenominal adjectives is determined by the definiteness of the nominal phrase and the number and gender of the noun. Non-neuter nouns always require an *e*-suffix on the adjective; neuter nouns require an *e*-suffix if they are definite or plural and a zero affix if they are indefinite. See the examples in (i).

- | | |
|------------------------------|----------------------------------|
| (i) [-neut, +/-def, +/-plur] | de/een andere afspraak(en) |
| | 'the/a different appointment(s)' |

[+neut, +def, +/-plur]	het/de andere nummer(s) 'the different number(s)'
[+neut, -def, -plur]	een ander ϕ nummer 'a different number'

3. Although my account involves an empty element in T, it is no null modal hypothesis in the sense of e.g. Boser et al. (1992). Hoekstra & Hyams (1998) raise the following arguments against a null modal hypothesis: (1) there is no topicalisation in RIs (2) there is no wh-movement in RIs (3) the cross-linguistic fact that only languages which mark Number exclusively show an RI stage (4) the co-occurrence of null subjects and RIs is not explained if RIs are 'finite sentences with a null modal'. I don't know whether the occurrence of RIs in agrammatism is restricted to languages which mark Number exclusively. However, the other arguments against a null modal hypothesis are not problematic for my account. The absence of topicalisation and wh-movement is due to the absence of CP, which is required to get a discourse interpretation for the empty Tense element. I assume that Tense is underspecified, and consequently, that no structural nominative is available. Under my account, RIs are not just finite sentences with a null modal.

4. Some authors, for example Ouhalla (1993), assume that DPs need case, but NPs do not. Under this view, the unavailability of structural nominative case excludes the presence of pronoun subjects, but the presence of determinerless subjects is not automatically excluded. In general, agrammatic patients do omit determiners. It is a peculiarity of patient GS that she does not omit determiners. Her RIs involve null subjects and full DP objects. The RIs of other agrammatics in the spontaneous speech of the AAT interview and the ANELT test involve null subjects and determinerless objects. So, although these patients do omit determiners, they nevertheless produce null subjects and no determinerless subjects. This might be a task effect. One of the agrammatics, patient HB, shows the following distribution of subject types in finite sentences: 121 pronoun subjects, 6 determinerless subjects and 12 full DP subjects. If we assume that there is no difference between finite and non-finite utterances, the target subjects in the AAT interview and the ANELT test are pronoun subjects. If pronoun subjects are the target, we do expect null subjects instead of determinerless subjects in the case of unavailability of nominative case (as in RIs).

References

- Abney, S. 1987. *The English noun phrase in its sentential aspect*. PhD Dissertation, MIT.
- Barbiers, S. 1992. 'Adjectives as auxiliaries of the noun phrase', *Linguistics in The Netherlands*, 10.
- Bennis, H, F. Beukema & M. den Dikken. 1997. 'Getting verb movement', *Linguistics*, 35: 1003-1028.
- Bennis, H, N. Corver & M. den Dikken. 1998. 'Predication in nominal phrases', *Journal of comparative Germanic linguistics*, 1: 1-33.

Blomert, L., Ch. Koster & M.-L. Kean. 1995. *Amsterdam-Nijmegen Test voor Alledaagse Taalvaardigheid (ANTAT)*. Lisse: Swets & Zeitlinger.

Boser, K., B. Lust, L. Santelmann & J. Whitman. 1992. 'The syntax of CP and V2 in early child German', *NELS*, 23: 51-65.

Ferdinand, A. 1996. *The development of functional categories, The acquisition of the subject in French*. PhD Dissertation, Leiden University.

Friedmann, N. & Y. Grodzinsky. 1997. 'Tense and Agreement in agrammatic production: Pruning the syntactic tree', *Brain and Language*, 56: 397-425.

Graetz, P., R. de Bleser & K. Willmes. 1992. *De Akense Afasie Test, Ned. Versie*. Lisse: Swets & Zeitlinger.

Haegeman, L. 1996. 'Root infinitives, clitics and truncated structures', H. Clahsen (ed) *Generative perspectives on language acquisition*. 271-307.

Hagiwara, H. 1995. 'The breakdown of functional categories and the economy of derivation', *Brain and Language*, 50: 92-117.

Hoekstra, T. & N. Hyams. 1995. 'The syntax and interpretation of dropped categories in child language: A unified account', *Proceedings of WCCFL XIV*.

Hoekstra, T., N. Hyams & M. Becker. 1996. 'The underspecification of Number and the licensing of root infinitives', *BUCLD 20 Proceedings*: 293-306.

Hoekstra, T. & N. Hyams 1998. Aspects of root infinitives. ms. UCLA.

Lasser, I. 1997. *Finiteness in adult and child German*. PhD Dissertation, City University of New York.

Mc Entee, L. 1993. *Morphosyntactic aspects of agrammatism*. PhD Dissertation, University New Castle Upon Tyne.

Ouhalla, J. 1993. 'Functional categories, agrammatism and language acquisition', *Linguistische Berichte*, 143: 3-36.

Ritter, E. 1991. 'Functional categories in Noun Phrases', S. Rothstein (ed) *Syntax and semantics 25, Perspectives on phrase structure: Heads and licensing*: 37-62.

Rizzi, L. 1994. 'Early null subjects and root null subjects', T. Hoekstra & B. Schwartz (eds) *Language acquisition studies in generative grammar*: 151-176.

Roo, de E. 1997. 'Dissociation between the nominal and verbal domain in agrammatic speech', J. Coerts & H. de Hoop (eds) *Linguistics in The Netherlands 1997*: 183-194.

Roo, de E. in prep. *Agrammatic grammar: Functional categories in agrammatic speech*. PhD Dissertation, Leiden University.

Szabolsci, A. 1994. 'The noun phrase', *Syntax and semantics*, 27, 179-274.

Zanutini, R. 1991. *Syntactic properties of sentential negation, a comparative study of Romance languages*. PhD Dissertation, University of Pennsylvania.

*Esterella de Roo, Holland Institute of Generative Linguistics
Leiden University, roo@rullet.leidenuniv.nl*

The Interplay between Grammar and Discourse: The Case of the Japanese Topic Marker *Wa* in Subordinate Clauses

Mitsuaki Shimojo

State University of New York at Buffalo

1. Overview

In studies of various morphosyntactic phenomena across languages, the interplay between sentence-level constraints (i.e. grammar) and the context in which the sentence is used (i.e. discourse) has been captured in one way or another (e.g. Kuno 1987, Van Valin and LaPolla 1997). The study of the topic marker *wa* in Japanese is no exception. This study will discuss the use of *wa* in subordinate clauses and illustrate how the dynamics of grammar-discourse interplay captures variable acceptability of *wa* in different subordinate clauses.

In Japanese, the nominal relations of a sentence are expressed by postnominal particles. For example, in (1), the postnominal particles express the grammatical relations, in this example, nominative, dative, and accusative respectively.¹

- (1) Taro ga Hanako ni tegami o okutta
NOM DAT letter ACC sent
'Taro sent a letter to Hanako.'

The topic particle *wa* is traditionally labeled as an adverbial particle, and it is different from the case particles in that it does not express a case relation but it can be used to “topicalize” almost any sentence element. For example, in (2), all the sentences express the same truth-conditional meaning “Taro sent a letter to Hanako”;

however, the sentences consist of different “topic” phrases. In (2a), the subject NP is topicalized, in (2b) it's the object NP that is topicalized. In (2c), the dative NP is topicalized.²

- (2a) Taro wa Hanako ni tegami o okutta
 TOP DAT letter ACC sent
 'As for Taro, (he) sent a letter to Hanako.'
- (2b) tegami wa Taro ga Hanako ni okutta
 letter TOP NOM DAT sent
 'As for the letter, Taro sent (it) to Hanako.'
- (2c) Hanako (ni) wa Taro ga tegami o okutta
 DAT TOP NOM letter ACC sent
 'As for Hanako, Taro sent a letter to (her).'

While *wa* exhibits a wide range of usage, there are morphosyntactic constraints. One of the well-known constraints is that the use is generally restricted in subordinate clauses (cf. Kuno 1973, Makino 1982), and the constraint is typically observed in subordinate clauses such as a noun-modifying clause, as shown in (3).

- (3) [Taro ga/*wa tsukutta] sushi o Hanako ga tabeta
 NOM/TOP made ACC NOM ate
 'Hanako ate sushi which Taro made.'

2. Classification of subordinate types by Minami (1974, 1993)

While it is the case that *wa* is in general restricted in a subordinate clause, it has also been observed that *wa* appears in some subordinate clauses quite frequently. Minami (1974) claims three subordinate types as shown in Table 1: Types A, B, and C, in terms of the compatibility with a variety of suffixes, i.e. whether a particular suffix can appear within the subordinate clause. He

states that *wa* may appear in Type C, i.e. those clauses with 'but', 'because', and 'and/then' expressed by the '-te' linkage.³

Note that Minami's classification is based upon the morphological characteristics of subordinate elements, and his claim is the classification per se, and not an explanation of why *wa* appears in particular subordinate clauses.

Furthermore, Minami (1993) presents the results from his frequency counts of *wa* and *ga* in novels and essays, as shown in Table 2. The subject marker *ga* appears frequently in both Type B and C, while *wa* appears frequently in Type C only.⁴

Table 1: Minami's (1974, 1993) subordinate types (abridged)⁵

	Subordinate types	-nai (negative)	-mai /-daroo -u/yoo (conjecture)	<i>ga</i> (subject) phrase	<i>wa</i> (topic) phrase
A	- <i>nagara/tsutsu</i> 'while'	no	no	no	no
	- <i>te</i> (manner)	no	no	no	no
	renyooshiki (verb stem) reduplication	no	no	no	no
B	- <i>te</i> (same subject, reason)	yes	no	yes	no
	- <i>nagara/noni</i> 'though'	yes	no	yes	no
	- <i>node</i> 'because'	yes	no	yes	yes/no
	- <i>to/baitara/nara</i> 'if'	yes	no	yes	no
	renyookei (verb stem)	no	no	yes	no
	- <i>zu</i> (negative)	no	no	yes	no
	- <i>naide</i> (negative)	no	no	yes	no
C	- <i>galkeredo</i> 'but'	yes	yes	yes	yes
	- <i>kara/shi</i> 'because'	yes	yes	yes	yes
	- <i>te</i> 'and then' (different subject)	yes	no	yes	yes

Table 2: Frequency of *wa* and *ga* in novels/essays in terms of subordinate type (Minami 1993)

	Subordinate types	# of <i>wa</i>	# of <i>ga</i>
A	- <i>nagara</i> 'while'	0	1
B	- <i>node</i> 'because'	11	32
	- <i>noni</i> 'though'	8	18
	- <i>ba/to/tara/nara</i> 'if'	3	55
C	- <i>galkeredo</i> 'but'	84	39
	- <i>kara/shi</i> 'because'	79	54

3. Degree of matrixhood of subordinate clause (Shimojo 1995)

Unlike Minami's (1974, 1993) analysis, subordinate clauses may be classified from a functional perspective. I have proposed in Shimojo (1995) that some subordinate clauses are functionally more independent, and therefore, more similar to matrix clauses, while other subordinate clauses are functionally more dependent on the matrix clause. Thus, the degree of matrixhood of a subordinate clause is higher if it is more independent, while the degree of matrixhood is lower if the subordinate clause is more dependent on the matrix clause. I use two criteria to measure the degree of matrixhood of a subordinate clause, as stated in (4).

- (4) The matrixhood of a subordinate clause is high, if:
- (a) A WH question out of a subordinate clause can be answered without a matrix element. (WH Q test)
 - (b) The information expressed by a subordinate clause can be negated without a matrix element. (Negation test)

If a WH question out of a subordinate clause can be answered or the information expressed by a subordinate clause can be negated without a matrix element, what is questioned or negated in the subordinate clause is what is to be identified in the context; therefore, in these cases, the subordinate clause is informationally independent of the matrix clause. On the other hand, if a WH question out of a subordinate clause cannot be answered or the information expressed by a subordinate clause cannot be negated without a matrix element, what is to be identified in the context is expressed by the matrix clause and what is questioned or negated in the subordinate clause is supplementary to the information expressed by the matrix clause.⁶

Examples (5) through (11) illustrate how the criteria indicated in (4) differentiate some subordinate clauses from the others.⁷ With noun complement, relative clause, *-tara* 'if', and *-toki* 'when', it is awkward to answer a WH question out of the subordinate clause or negate the information expressed by the subordinate clause only

with the subordinate element, as shown in (5)-(8). With clausal complements, *-kara* and *-shi* "because", on the other hand, it is possible to answer a WH question formed out of the subordinate clause or negate the information expressed by the subordinate clause without a matrix element, as shown in (9)-(11).

(5) Noun complement (WH Q test)

A: Ken wa [dare ga okane o nusunda toiu] uwasa o
 TOP who NOM money ACC stole QT rumor ACC

shinjiteiru no?

believe FP

'Who does Ken believe the rumor that __ stole the money?'

B:# [Taro]

'(It's) Taro.'

B': [Taro ga nusunda toiu] uwasa
 NOM stole QT rumor

'The rumor that Taro stole (it).'

(6) Relative clause (WH Q test)

A: [dono kyooju ga suisenshiteiru] hito ga saiyoosare soo?⁸
 which prof. NOM recommending person NOM be-emp. likely
 'A person that which professor is recommending is likely to
 be employed?'

B:# [Suzuki kyooju]
 prof.

'(It's) prof. Suzuki.'

B': [Suzuki kyooju ga suisenshiteiru] hito
 prof. NOM recommending person

'The person whom Prof. Suzuki is recommending.'

(7) *-tara* 'if' (negation test)

A: [Taro ga ki tara] party ga owaranai
 NOM come if paatii NOM end:NEG
 'The party will never end if Taro comes.'

B:# iya, [Hanako]
 no
 'No, (if it's) Hanako.'

B': iya, [Hanako ga ki tara] owaranai
 no NOM come if end:NEG
 '(It) will never end if Hanako comes.'

(8) *-toki* 'when' (negation test)

A: [Taro ga sotsugyooshita toki] daitooryoo wa Bush datta
 NOM graduated when president TOP COP:PAST
 'The president was Bush when Taro graduated.'

B:# iya, [Hanako]
 no
 'No, (it was) Hanako.'

B': iya, [Hanako ga sotsugyooshita toki] Bush datta
 no NOM graduated when COP:PAST
 '(It) was Bush when Hanako graduated.'

(9) Clausal complement (WH Q test)

A: Ken wa [dare ga okane o nusunda tte] shinjiteiru no?
 TOP who NOM money ACC stole QT believe FP
 'Who does Ken believe that __ stole the money?'

B: [Taro]
 '(It's) Taro.'

B': [Taro ga okane o nusunda tte] shinjiteiru
 NOM money ACC stole QT believe
 '(He) believes that Taro stole the money.'

(10) *-kara* 'because' (WH Q test)

A: Ken wa [dare ga party ni iku kara] iku tte?
 who NOM to go because go QT
 'Will Ken go to the party because who will go(to the party)?'

B: [Hanako]
 '(It's) Hanako.'

B': [Hanako ga iku kara] iku tte
 NOM go because go QT
 '(He) will go because Hanako will go.'

(11) *-shi* 'because' (negation test)

A: Hanako wa [piano mo hiku-shi] sainoo aru yo ne
 TOP also play-because talent exist FP FP
 'Hanako is talented because she plays the piano too.'

B: iya, [baiorin]
 no violin
 'No, (It's) the violin.'

B': iya, [baiorin mo hiku-shi] sainoo aru n da yo
 violin also play-because talent exit N COP FP
 'No, she is talented because she plays the violin.'

Table 4 summarizes the classification of subordinate types, based upon the two tests in (4). Noun modifying clauses (i.e. noun complement and relative clause), 'if' and 'when' are grouped together as their matrixhood is low, while the matrixhood of a clausal complement and 'because' clause is high.

Table 4: Subordinate types in terms of degree of matrixhood

matrixhood	subordinate type	WH Q test	Negation test
low	noun modifying clause	no	no
	- <i>ba/to/tara/nara</i> 'if'	no	no
	- <i>toki</i> 'when'	no	no
high	clausal complement	yes	yes
	- <i>node/kara/shi</i> 'because'	yes	yes

Table 5 shows the frequency of *wa* and *ga* in four hours of conversational Japanese from a TV talk show, presented in Shimojo (1995). The token distribution indicates that the classification of subordinate clause in terms of the notion of matrixhood corresponds with the frequency of *wa* in the conversational Japanese data examined.

Table 5: # of *wa/ga* marking subject in subordinate clause

matrixhood	subordinate predicate	# of <i>wa</i> marking subject	# of <i>ga</i> (subject marker)
low	noun modifying clause	0	27
	- <i>ba/to/tara/nara</i> 'if'	2	16
	- <i>toki</i> 'when'	1	10
high	clausal complement	24	51
	- <i>node/kara/shi</i> 'because'	21	37

4. Discourse-level constraint on the use of *wa*

Discourse functions of *wa* have been characterized in different ways in different literature. In this study, I use the notion of *activation* (cf. Chafe 1994, Dryer 1996) and characterize *wa* as a marker of activated information. A particular element becomes activated or deactivated in the individual's consciousness, and information may be nonactivated (least activated) or the center of attention (most activated), or in a stage between the two extremes. For example, Dryer (1996) identifies a continuum consisting of four stages of activation: (1) center of attention, (2) activated but not center of attention, (3) recently activated but now semi-deactivated, or accessible to activation, and (4) nonactivated. A

particular piece of information may be not activated at all in the hearer's consciousness until it is mentioned. At the moment of mention, it becomes activated. However, it becomes deactivated if attention is not drawn to it in the subsequent context.

In order to measure the degree of activation, I used the measurement method of *referential distance* (RD), used in Givón (1983). The RD of a particular element is measured by counting the number of clauses backward to the most recent mention of the coreferential expression. Moreover, I assume that the smaller the RD is, the more activated the particular referent is in the individual's consciousness. In Shimojo (1995), I applied the RD measurement to a database from the four-hour TV talk show mentioned earlier, and I measured the RD for two kinds of elements: (i) a referent expressed by a subject marked with *wa* or *ga*, and (ii), an open proposition which the *wa/ga*-marked subject combines with. For example, for the sentence in (12), I measured the RD of the two entities: "John", the subject, and the open proposition "X went to the party" (where X is a variable).

- (12) John wa paatii ni itta
 TOP party to went
 'John went to the party.'

Table 6 summarizes the four possible activation patterns in terms of the RD of the *wa/ga*-marked subjects and the open propositions: (1) the RD of *wa/ga*-marked subject is smaller than the RD of the open proposition, i.e. the former is more activated than the latter, (2) the RD of *wa/ga*-marked subject is larger than the RD of the open proposition, i.e. the open proposition is more activated than the *wa/ga*-marked subject, (3) neither of the two elements is previously mentioned in the discourse; they are both equally nonactivated, and (4) the two elements are both previously mentioned and the RD is identical; they are equally activated. As shown in the results, *wa* appears primarily in the first activation pattern; i.e. when the subject is more activated than the open proposition, and *ga* appears elsewhere. This finding from the

conversation data suggests that *wa* typically appears in the marked activation pattern as discussed above, in contrast with *ga*, which typically appears elsewhere.⁹

Table 6: Four activation patterns and total number of tokens from matrix clauses

Degrees of activation of <i>wa/ga</i> -subject and open proposition	sentence with <i>wa</i>	sentence with <i>ga</i>	Total
(1) RD of <i>wa/ga</i> -subject < RD of open proposition	96 (70%)	41 (30%)	137 (100%)
(2) RD of <i>wa/ga</i> -subject > RD of open proposition	8 (6%)	118 (94%)	126 (100%)
(3) RD of <i>wa/ga</i> -element = RD of open proposition = not previously mentioned	21 (17%)	100 (83%)	121 (100%)
(4) RD of <i>wa/ga</i> -element = RD of open proposition = previously mentioned	0 (0%)	29 (100%)	29 (100%)

5. The interplay between matrixhood and activation pattern

Finally, this section examines how the matrixhood of a subordinate clause and the activation patterns discussed above interplay in terms of varying acceptability of *wa* in subordinate clause. There are four possible combinations of the two criteria: (1) low matrixhood with a *wa*-like activation pattern, (2) low matrixhood with a *ga*-like activation pattern, (3) high matrixhood with a *wa*-like activation pattern, and (4) high matrixhood with a *ga*-like activation pattern. The four patterns are shown in examples in (14) to (21).

(13) shows an example of a noun-modifying clause where there is a *wa*-like activation pattern. In B's utterance, the noun-modifying clause has the subject "Taro", which is mentioned in (13A), i.e. previously activated, while the open proposition "X kisses Hanako" is not previously activated. Here, *ga* is preferred over *wa* because of the low matrixhood of the subordinate clause, in spite of the *wa*-like activation pattern. Interestingly, however, *wa* is not totally unacceptable due to the activation pattern. The subordinate clause in (14B) is identical to that in (13B); however, it has a *ga*-

like activation pattern; neither the subject nor the open proposition is previously activated. Hence, *ga* is the only choice here.

Sentences (15) and (16) are examples with *-tara* 'if'. In this particular case, *ga* is the only choice due to the low matrixhood, regardless of the activation pattern.

Examples (17) to (20) are instances of high matrixhood. In a subordinate clause of high matrixhood, the activation pattern alone accounts for the acceptability of *wa*, which is analogous to the use of *wa* in a matrix clause. However, *ga* is sometimes as acceptable as *wa*, as in (19B), even when the activation pattern favors *wa*, and this indicates the overall preference for *ga* in subordinate clauses.

(13) low matrixhood (N-modifying clause) & *wa*-like act. pattern

A: sono dorama ni Taro mo deteru n da tte?

that drama in also appear N COP QT

'(I heard) Taro appears in the drama too, doesn't he?'

B: un. [Taro *ga*/?*wa* Hanako ni kiskusuru] shiin ga aru yo

yeah NOM/TOP to kiss scene NOM exist FP

'Yeah, there is a scene in which Taro kisses Hanako.'

(14) low matrixhood (N-modifying clause) & *ga*-like act. pattern

A: sono dorama no dono shiin ga suki?

that drama GEN which scene NOM like

'Which scene of the drama do you like?'

B: [Taro *ga*/**wa* Hanako ni kiskusuru] shiin

NOM/TOP to kiss scene

'(It's) the scene where Taro kisses Hanako.'

(15) low matrixhood (*-tara* 'if') & *wa*-like act. pattern

A: Taro no gaarufurendo wa dare kana

GEN girlfriend TOP who wonder

'I wonder who Taro's girlfriend is.'

B: demo [Taro no gaarufurendo ga/*wa H. da ttara] odoroki da
 but GEN girlfriend NOM/TOP COP if surprise COP
 'But I'd be surprised if Taro's girlfriend is Hanako.'

(16) low matrixhood (-*tara* 'if') & *ga*-like act. pattern

A: Ken no gaarufurendo wa Hanako da tte Taro ga itta
 GEN girlfriend TOP COP QT NOM said
 'Taro said that Ken's girlfriend is Hanako.'

B: [Taro no gaarufurendo ga/*wa Hanako nara] odoroki da
 GEN girlfriend NOM/TOP if surprise COP
 'I'd be surprised if Taro's girlfriend is Hanako.'

(17) high matrixhood (clausal comp.) & *wa*-like act. pattern

A: Taro no gaarufurendo ga dare ka shitteru?
 GEN girlfriend NOM who Q know
 'Do you know who Taro's girlfriend is?'

B: iya, demo John wa [Taro no gaarufurendo wa/?ga
 no but TOP GEN girlfriend TOP/NOM

Hanako da to] shinjiteiru
 COP QT believe

'No, but John believes that Taro's girlfriend is Hanako.'

(18) high matrixhood (clausal comp.) & *ga*-like act. pattern

A: John ga doo shita no?
 NOM how did FP
 'What about John?'

B: J. wa [T. no gaarufurendo ga/*wa Hanako da to] shinjiteiru
 TOP GEN girlfriend TOP/NOM COP QT believe
 'John believes that Taro's girlfriend is Hanako.'

(19) high matrixhood (*-kara* ‘because’) & *wa*-like act. pattern

A: Hanako ga John to kenkashita n da tte

NOM with quarrel N COP QT

‘(I heard) Hanako had an argument with John.’

B: un. [Hanako wa/ga naishode Taro to atta kara ne]

yeah TOP/NOM secretly with met because FP

‘Yeah, because Hanako met Taro secretly.’

(20) high matrixhood (*-kara* ‘because’) & *ga*-like act. pattern

A: dooshite John wa okotteru no?

why TOP upset FP

‘Why is John upset?’

B: [Hanako ga/*wa naishode Taro to atta kara ne]

TOP/NOM secretly with met because FP

‘Because Hanako met Taro secretly.’

Figure 1 summarizes the interplay of the two scales illustrated above. Dimension (1) indicates the case in which there is high matrixhood and a *wa*-like activation pattern. Here either *wa* or *ga* may appear, though sometimes *ga* is not as acceptable as *wa*. Dimension (2) indicates the case in which there is low matrixhood and *wa*-like activation pattern. Here *ga* is preferred due to the low matrixhood, regardless of the activation pattern. However, as in (13), *wa* may not be totally unacceptable, due to the activation pattern. Dimensions (3) and (4) indicate that *ga* is the only choice when there is a *ga*-type activation pattern, regardless of the matrixhood of the subordinate clause. Overall, in any instance, *ga* is never completely ruled out, even when it is not preferred, regardless of the matrixhood and the activation pattern, and this overall preference for *ga* indicates the general constraint on the use of *wa* in subordinate clauses.

Given the two different perspectives, one on the sentence level and the other on the discourse level, we can capture the dynamics between the two different levels and their subtle interplay in the

choice of the morphological marking for the subordinate subject. Each level in isolation is insufficient to account for the complex distribution of *wa*. As demonstrated above, with the integration of the two levels, the use of *wa* in subordinate clauses can be captured more thoroughly.

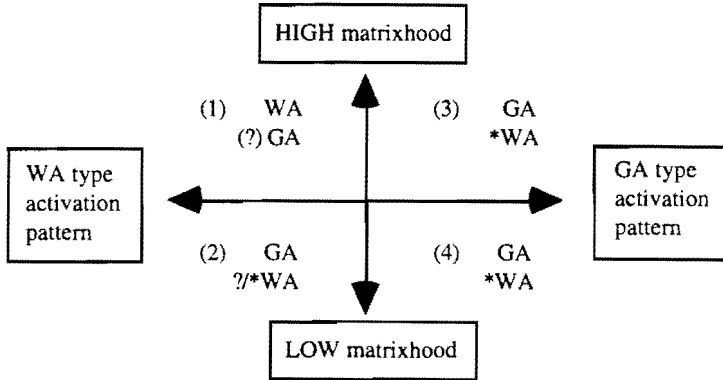

Figure 1: Interplay between matrixhood and activation pattern

Notes

¹In the English gloss, the following abbreviations are used throughout: ACC=accusative marker, COP=copula, DAT=dative marker, FP=final particle, GEN=genitive marker, N=nominalizer, NEG=negative, NOM=nominative marker, Q=question marker, QT=quotation marker, TOP=topic marker.

²While the conventional gloss of *wa* is "as for" as shown in the examples, "as for" does not fit the translation in many cases of *wa* in Japanese discourse.

³Noda (1996) presents a similar analysis on the basis of Minami (1993). Noda labels Minami's Type B as *strong* subordinate clause and Type C as *weak* subordinate clause. Noda points out that subordinate clauses with *kara*, *node*, *noni* 'because' are strong when there is focus on the subordinate clause, while they are weak when there is no focus. Noda (1996: 177) defines focus as information which the speaker wants to convey in the context.

⁴Although Minami (1993) does not explicitly state, the tokens of *wa* in Table 2 include cases in which *wa* marks non-subjects.

⁵Besides the morphemes in this table, Minami (1974, 1993) tests the compatibility with *-masu* (polite adverbial verbal ending), *-talda* (past adverbial verbal ending), honorific verbal form, causative, passive, etc.

⁶Hasegawa (1989) uses the distinction between what is questioned by a question and what is to be identified for the purpose of the communication, and she points out the two may or may not coincide, depending on various factors.

⁷The examples here are by no means exhaustive.

⁸This example is from Nishigauchi 1984, though it is slightly modified. It is sometimes possible to truncate an answer to a WH question formed out of a relative clause. See Hasegawa (1989) for discussion.

⁹See Shimojo (1995) for discussion of deviant cases to this pattern.

References

- Chafe, Wallace. 1994. *Discourse, consciousness, and time*. Chicago: University of Chicago Press.
- Dryer, Matthew. 1996. "Focus, pragmatic presupposition, and activated propositions", *Journal of Pragmatics*. 26: 475-523.
- Givón, Talmy. (ed.) 1983. *Topic continuity in discourse: a quantitative cross-language studies*. Amsterdam: John Benjamin.
- Hasegawa, Yoko. 1989. "Questioning vs. identifying: a functionalist analysis of the [a candidate that which professor recommended was hired?] construction in Japanese", *Proceedings of the Fifteenth Annual Meeting of the Berkeley Linguistics Society*. 138-149.
- Kuno, Susumu. 1973. *The Structure of the Japanese language*. Cambridge, Mass: MIT Press.
- Kuno, Susumu. 1987. *Functional syntax: anaphora, discourse, and empathy*. Chicago: University of Chicago Press.
- Makino, Seiichi. 1982. "Japanese grammar and functional grammar", *Lingua*. 57: 125-173.
- Minami, Fujio. 1973. *Gendai nihongo no koozoo (Structure of modern Japanese)*. Tokyo: Taishukan.
- Minami, Fujio. 1993. *Gendai nihongo bunpoo no rinkaku (Outline of modern Japanese grammar)*. Tokyo: Taishukan.
- Nishigauchi, Taisuke. 1984. "Japanese LF: Subjacency vs. ECP", *Seoul papers on formal grammar theory*.
- Noda, Hisashi. 1996. *Wa to ga (Wa and ga)*. Tokyo: Kuroshio.
- Shimojo, Mitsuaki. 1995. *Focus structure and morphosyntax in Japanese: wa and ga, and word order flexibility*. PhD dissertation, State University of New York at Buffalo.
- Van Valin, Robert. and Randy LaPolla. 1997. *Syntax: structure, meaning and function*. Cambridge: Cambridge University Press.

Mitsuaki Shimojo
 Department of Modern Languages and Literatures
 State University of New York at Buffalo
 Buffalo, NY 14260-4620
 shimojo@acsu.buffalo.edu

Extended Sympathy and English Hypocoristic Truncation

Seung-Hoon Shin
Dongseo University

1 Preliminaries

Since Optimality Theory (OT) was first proposed by Prince and Smolensky (1993) and McCarthy and Prince (1993), one of the potential problems of OT which is against serial derivation in principle and does not posit any intermediate representations has been as to how to handle the form which is neither input nor output. Hence McCarthy (1997, 1998) has recently proposed Sympathy Theory as a sub-theory of OT and has argued that such form is a sympathetic candidate. The aim of this paper is three folds. First, this paper will illustrate that English hypocoristic truncation reflects faithfulness to a sympathetic candidate. Second, Markedness and phonological constraints (Phono-constraints) as well as Input-Output faithfulness (IO-Faithfulness) constraints must be used as selector (\mathbb{N}) of \mathbb{N} -candidates (flowered candidate) even though a sympathetic candidate is not an independent phonological word. This implies that even a sympathetic candidate should respect a part of phonological regularity of a given language and universal grammar. Third, given that English has several different types of hypocoristics depending on its stress pattern, this paper will contend that Base-Truncated Form correspondence (BT-Correspondence) constraints also play the role as the \mathbb{N} -selector of \mathbb{N} -candidates.

The remainder of this paper will be organized as follows. In Section 2, I will raise the issue of phonological opacity. In Section 3, I will introduce the notion of sympathy. In Section 4 I will explore sympathetic faithfulness and the properties of \mathbb{N} -selector based on English hypocoristic truncation.

2 Phonological Opacity and Problem of Intermediate Forms

In the rule-based approaches, a major framework is the serial derivation which posits intermediate representations such as /ADC/ in number (1) or *de.æ?* in (2).

(1) Counterbleeding relation

UR	/ABC/#
B ---> D / _____ C	/ADC/#
C ---> E / _____ #	[ADE]#

The two rules in (1) are in a counterbleeding relation, and the output ADE is considered to be derived from the intermediate representation ADC in the rule-based approaches. An actual example is given in (2). In Tiberian Hebrew, epenthesis first applies between two consecutive consonants and then glottal stop deletion applies word-finally as stated in (2). Those rules are in a counterbleeding relation.

(2) Counterbleeding relation in Tiberian Hebrew (McCarthy 1998)



Epenthesis: Insert a vowel between the two consecutive consonants of a word-final cluster.

ʔ-deletion: A glottal stop deletes when not prevocalic.

UR	/dešʔ/	'tender grass'
Epenthesis	dešeʔ	
ʔ-deletion	deše	
Output	[deše]	

As McCarthy (1997, 1998) pointed out, when we try to account for this kind of counterbleeding phenomenon within the framework of OT, the problem raised immediately is that the opaque form as in (3a) in the following tableau (3) never wins over the transparent form which is (3b).

(3) /dešʔ/ ---> [deše] 'tender grass'

	/dešʔ/	CodaCond	MAX-C	DEP-V
opaque (Intended Winner)	a.  deše		*	ɿ*!
transparent	b.  deš		*	
sympathetic	c. dešeʔ	*!		*

Hence, candidate (a) which has [e] at the end and does not have following [ʔ] cannot be a better form than candidate (c) which is more faithful to its input since the input lacks /e/ in between /s/ and /ʔ/.

In order to account for such phenomenon and to solve the problem of intermediate forms in OT, McCarthy proposes another correspondence relation.

sympathy or ☉ -correspondence which refers to candidate-to-candidate faithfulness. Section 3 will introduce this co-candidate correspondence.

3 Inter-Candidate Correspondence: Sympathy

3.1 ☉ -correspondence

As McCarthy (1997, 1998) proposed, *sympathy* is a type of correspondence between candidates. This correspondence relation, which was named flowered (☉) correspondence, is stated in (4).

- (4) ☉ -correspondence (McCarthy 1997:9)
 ☉ -correspondence relates (a) designated member of output candidate set to (the) whole set (of candidates). (The) Designated member is (the) most harmonic candidate obeying some specified faithfulness constraint.



Given this notion of co-candidate correspondence, ☉ MAX and ☉ DEP can be defined as in (6) based on the basic IO-Faithfulness constraints. MAX and DEP stated in (5).

- (5) a) MAX: Every segment in the input has a correspondent in the output
 b) DEP: Every segment of the output has a correspondent in the input.
- (6) Flowered constraints
 a) ☉ MAX: Every segment in the flowered candidate has a correspondent in the output.
 b) ☉ DEP: Every segment in the output has a correspondent in the flowered candidate.

Relying on the notion of this sympathy and on the Phono-constraint, Coda Condition which is described in (7), the tableau in (8) accounts for Tiberian Hebrew case described earlier.

- (7) Coda Condition (CodaCond): Glottals are not allowed in the coda position.

(8) /dešʔ/ ---> [deše] 'tender grass' (McCarthy 1998:12)

	/dešʔ/	CodaCond	*MAX-V	MAX-C	DEP-V
opaque	a.  deše			*	*
transparent	b.  deš		*!	*	
Sympathetic	c.  deše	*!			*

The transparent candidate (b) which lacks [e] at the end, cannot be the best output since it is not faithful to the flowered candidate which is (c). Hence, candidate (a) is correctly chosen as the optimal output since it respects both CodaCond and, more importantly, the sympathetic constraint *MAX, which requires the candidate to be as faithful to the flowered candidate, not to the input, as it can.

Now, the question we have in the tableau in (8) is about *-selector which picks up candidate (c) as the *-candidate. Section 3.2 addresses this issue about *-selector of a sympathetic candidate.

3.2 *-Selector of *-candidates

Since McCarthy (1998) has proposed Sympathy Theory, one of the key issues is about *-selector which pick up sympathetic candidates. So, McCarthy (1998) claims that only IO-Faithfulness constraints such as MAX and DEP in (5) serve as *-selector as stated in (9).

(9) Confinement to C_{-F} (McCarthy 1998:18)

Selection of the *-candidate N_F is confined to C_{-F} , the set of candidates that obey the IO faithfulness constraint F.

However, dealing with several patterns of Ponapean nasal substitution in the process of reduplication, Davis (1997a, b) contends that Base-Reduplicant Correspondence (BR-Correspondence) constraints as well as IO-Faithfulness constraints should also play the role as *-selector as in (10) (See Davis (1997a, b) for more details).

(10) Davis (1997a, b): BR-Faithfulness can serve as C.

On the other hand, based on German hypocoristic truncation, Itô and Mester (1997) claim that even Markedness constraints should act as ✱-selector, proposing so-called “Extended Sympathy” stated in (11).

(11) Extended Sympathy (Itô and Mester 1997:127)

Other types of constraints besides Faithfulness, can serve as C (the constraint determining the sympathetic candidate....)

In the following section, I will first show the formation of English hypocoristics. Based on the patterns of truncation, I will maintain that in addition to IO-Faithfulness constraints, Markedness constraints and even Base-Truncated Form Identity (BT-Identity) constraints should select ✱-candidates.

4 Extended Sympathy in English Hypocoristics

4.1 Hypocoristic Truncation

One type of English hypocoristics is formed by truncating a name and adding the affix /i/ which is spelled as *-y*, *-ie* or *-ey*. Such hypocoristics can be divided into three groups depending on the patterns of truncational processes as in (12).

(12) English Hypocoristic Truncation
 (Data in (a) and (b) from Davis (1996))

a) Group 1

<i>Full name</i>	<i>Hypocoristic</i>	<i>Wrong output</i>
Sigmund	Siggy	*Sigmy
Douglas	Dougie	*Douglie
Edward	Eddy	*Edwy
Patricia	Patty	*Patry
Andrew	Andy	*Andry
Robert	Robby	*Robry
Gabriell	Gabby	*Gabry
Abigail	Abbey	*Abgy
Howard	Howie	*Howrie
Patricia	Patty	*Patry
Harold	Harry	*Harly
Josephine	Josey	*Josefy
Fredrick	Freddy	*Fredry
Teresa	Terry	*Tersy
Kimberly	Kimmy	*Kimby

b) Group 2

<i>Full name</i>	<i>Hypocoristic</i>	<i>Wrong output</i>
Kandace	Kandy	*Kanny
Gordon	Gordy	*Gorry
Angela	Angie	*Annie
Charles	Charlie	*Charry
Kristine	Kristy	*Krisry
Barbara	Barby	*Barry
Bernard	Bernie	*Berry
Martin	Marty	*Marry
Precival	Percy	*Perry
Helmut	Helmy	*Helle

c) Group 3

<i>Full name</i>	<i>Hypocoristic</i>	<i>Wrong output</i>
Amanda	Mandy	*Amy, *Manny
Elizabeth	Lizzy, Betty	*Elly, *Liie
Roberta	Bertie	*Robby, *Berry

As Davis (1996) mentioned, the hypocoristics in the first group in (12) include only a single consonant right before the suffix, whereas those in the second group attain two consonants before the suffix. On the other hand, hypocoristics in Group 3, unlike the others, are based on the second or third syllable rather than the word-initial syllable.

These properties of the English hypocoristic truncation can be summarized in (13).

(13) Generalization of English hypocoristic truncation

- a) A hypocoristic is based on the maximally possible first syllable of the base form.
 - *Kandy* is from *Kand*, *Gordon* from *Gord* and *Albert* from *Alb*
- a') The final two consonants of the form to which the suffix is attached should have falling sonority.
 - *Sigmund* is realized not as *Sigmy* but as *Siggy* since *-gm* has rising sonority.
- b) The final two consonants of the form should respect English phonotactics.
 - *Kimberly* has *Kimmy* as its hypocoristic in lieu of **Kimby* since – *mb* is not a possible English coda. ($-(mb)_o$). (e.g., *iamb*, *bomb*, *comb* etc.)
- c) Hypocoristic formation is related to the stress pattern of the base
 - Hypocoristics in Group 3 keep their stressed syllables at the expense of losing their first syllable.

The generalization in (12) shows that even though the form to which the hypocoristic suffix is attached, is not an independent phonological word, the two consonants in the form should be an authentic English coda. Hence, as in normal English words, neither the syllable final *mb* cluster nor any consonant cluster with rising sonority at the end can appear in the form.

Of interest here is that such form is neither input nor output. That is, such forms are not outputs since they lack prosodic structure. Also, they cannot be inputs since English lexicon does not have such words. Consequently, following McCarthy (1997, 1998) and Itô and Mester (1997), I propose such a form is a sympathetic form to which the optimal form should be faithful. I will return this issue of sympathetic forms, shortly.

Given that such forms are sympathetic candidates, Section 4.2 will account for the formation of English hypocoristic truncation.

4.2 Sympathetic Faithfulness in English Hypocoristic Truncation

In order to account for the formation of English hypocoristics, we first need to formalize the properties given in (13) into constraints. Especially with respect to sonority of the final two consonants of the sympathetic form, the examples in (14) further show that the two consonants in the maximally possible first syllable of a name, which is a sympathy form, must have falling sonority.

(14) Sonority constraint in English hypocoristics

<i>Full name</i>	<i>Hypocoristic</i>	<i>Wrong output</i>
Victoria	Vicky	*Vicky
Hector	Heckie	*Hecty

The examples in (14) illustrate that the two consonants of a sympathetic form must have falling sonority. Hence, given this pattern of hypocoristic formation, I propose a constraint regarding sonority of a coda, which is stated in (15).

(15) CodaSonority (CodSon): Coda should have falling sonority.

The constraint requires the English coda even in the sympathy form to have a consonant cluster with falling sonority, thus ruling out those with even or rising sonority.

In addition, given that all this type of English hypocoristics is bisyllabic, following Prince and Smolensky, I propose a templatic constraint, FTBIN.

(16) FTBIN: (Prince and Smolensky 1993:47)

Feet are binary on a syllabic analysis.

As in the German case discussed by Itô and Mester (1997), the constraint which limits the number of syllables in the sympathetic form in English is Alignment constraint as in (17).

(17) Align-Left(σ , PrWd) (= All- σ -Left: Itô and Mester 1997:127)

Align the left edge of a syllable with the left edge of a prosodic word.

Hence the role of this constraint is to pick up only monosyllabic candidate as the sympathetic form.

The tableau in (18) shows constraint interaction of relevant constraints introduced so far, and accounts for the formation of English hypocoristics.

(18) Formation of Group (1) hypocoristics

/S + i/	MAX-Suffix	*MAX	*DEP	Base-Identity	CodSon	Align
a. * Pat	*!			****		
b. Patr	*!		*	***	*!	
c. Paty			*	*****		*!
d. Patry			**!	****		*!
e. Patricia	*!		****			*!*

The constraint tableau in (18) is a combination of two tableaux. That is, the constraints appeared in the right, containing CodSon and Alignment, are the

ones to choose the sympathetic candidate. By these constraints, candidate (a) is chosen as the flowered candidate. In the tableau, candidate (a) should be chosen as the sympathetic candidate in order to have *Patty* as the optimal output rather than the hypothetical form **Patty*. Then, in order to rule out candidate (b) and to pick up candidate (a) as the sympathetic candidate, it is necessary that the markedness constraint CodSon be used as the authentic sympathetic constraint. Hence, the tableau in (18) clearly shows that as Itô and Mester (1997) proposed, IO-Faithfulness constraints are not enough and even markedness constraints should serve as \star -selector. The consequence is that sympathetic candidates respects universal markedness even though it is not an independent word. With the high-ranking flowered constraints, candidate (c) which is more faithful to the flowered candidate becomes the optimal output.

The tableau in (19) accounts for the second type of English hypocoristics which were illustrated in (12b).

(19) Formation of Group 2 hypocoristics

/S + i/	MAX-Suffix	\star MAX	\star DEP	Base-Identity	CodSon	Align
a. Gor	*!	*		***		
b. \star Gord	*!			**		
c. \star Gory		*!	*	****		*!
d. Gordy			*	***		*!
e. Gordon	*!		***			*!*

As for the hypocoristics that keep two consonants right before the suffix as in (12b), flowered constraints pick up the sympathetic candidate with the two consonants as illustrated in (19). Both candidates (a) and (b) respect CodSon, but candidate (b) better respects Base-Identity and is chosen as the flowered candidate. Hence in the tableau, given *Gord* is the sympathetic candidate rather than *Gor*, candidate (d) which best respects sympathetic constraints emerges as the winning candidate.

The following tableau accounts for the case shown in (12c).

(20) Extended Sympathy: Phono-constraints

/S + i/	Max-Suffix	\star MAX	\star DEP	Base-Identity	*mb] _o	Align
a. \star Kim	*!			*****		
b. Kimb	*!		*	****	*!	
c. Kimby			**!	****		*!
d. \star Kimmy			*	*****		*!
e. Kimberlic	*!		****			*!

By means of the flowered constraints, *mb]_o and Alignment, candidate (a) which lacks word-final *mb* cluster is chosen as the flowered candidate. Again, in order to have the form as sympathetic candidate rather than candidate (b) which has unacceptable syllable-final *mb*, it is necessary that the Phono-constraint *mb]_o be used as an authentic sympathetic constraint even though the form *Kim* is not a complete phonological word in English. Now, with the sympathetic candidate *Kim, Kimmy*, which is the most faithful to the flowered candidate and respects the flowered constraints, is chosen as the best.

So far, we have examined several cases of English hypocoristic truncation. In the tableaux in (18), (19) and (20), we have seen that sympathetic forms play a crucial role in the production of hypocoristics. We have also seen that in order to have such forms as sympathetic candidates, it is necessary that the Markedness constraint and the Phono-constraint such as CodSon and *mb]_o, respectively, be used as authentic sympathetic constraints that pick up sympathetic candidates. This claim is contrary to McCarthy who proposes to use only IO-Faithfulness constraints as ✱-selector and is similar to Itô and Mester (1997) who argues for Extended Sympathy.

Importantly, this claim further implies that sympathetic forms have correspondence with regular English words. Hence, even though such sympathetic candidates are not regular phonological words, they respect phonological regularity of English and universal markedness.

In addition, interestingly, the third type hypocoristics given in (12c) show that hypocoristic truncation should reflect the stress pattern of the full name (base). The tableau in (21) accounts for this pattern where stress affects formation of hypocoristic truncation.

(21) Extended Sympathy: BT-constraints

	/S + i/	MAX-Suffix	✱MAX	Base-Ident	BT-Ident-Head	Align
a.	Rób	*!	***	****	*!	
b.	Bér	*!	*	****		
c.	✱ Bért	*!		***		
d.	Róbby		*!***	****	*!	*
e.	Béry		*!	****		*!
f.	✱ Bért			***		*!
g.	Robért	*!				*!

(“Head” in “BT-Identy Head” refers to a stressed syllable.)

Given the fact that truncated English hypocoristics have the same stress pattern with the corresponding full names, we need to have the flowered candidate which has the same stressed syllable as the regular output of a full name. This means that the BT-Identity constraint with respect to stress should play a role as selector of the flowered candidate. Here, the use of BT-Identity Head as ✱-selector is crucial. This claim that BT-Identity constraints should select ✱-candidates is similar to Davis (1997a, b) who proposes to use BR-Identity constraints as ✱-selector. Hence, the optimal output in the tableau in (19) must be faithful to the ✱-candidate with respect to stress, while keeping as much faithfulness to the base word as it can. Consequently, candidate (f) which respects ✱MAX by containing the stressed syllable and is the most faithful to the input emerges as the best.

5 Summary

In the paper, I contend that English hypocoristic truncation reflects faithfulness to a sympathetic candidate. Based on the patterns of English hypocoristic truncation, I also maintain that in addition to faithfulness constraints, markedness, phonological and even BT-Correspondence constraints must be included to the set of sympathetic constraints as selector of sympathetic candidates. This claim is contrary to McCarthy (1997, 1998) and is similar to Itô and Mester (1997) and partly to Davis (1997a, b) in the sense that other constraints in addition to IO-Faithfulness can serve as selector of sympathetic candidates. This claim further implies that even though a sympathetic candidate is not a complete word, it should respect phonological regularity of a given language and universal markedness as a candidate which has prosodic structure.

Notes

1. I am especially grateful to Davis Stuart for his many helpful comments. This work was supported by "New Faculty Research Grants" from Dongseo University.
2. According to Davis (1996), there are two more patterns that are worth discussing. These are shown in (1) and (2).

1) Group 4

<i>Full name</i>	<i>Hypocoristic</i>
Stuart	Stuey
Louise	Louie
Joel	Joey

2) Group 5

<i>Full name</i>	<i>Wrong output</i>
Leon	*Leyie
Leah	*Leyie
Diane	*Diyie

Full names both in Group 4 and in Group 5 are the same in the sense that they have hiatus (sequence of vowels) between the first two syllables. Names in Group 5, however, do not have corresponding nicknames, while those in Group 4 do. Davis (1996) argues that the first vowel in the first syllables of such names should be [-back]. Within the framework of OT, this is the consequence of high ranking local conjunctive constraint (See Smolensky 1993, Alderete, to appear for more about the notion of local conjunction) *[-back]_{hypocoristics} which prohibits two consecutive [-back] features in hypocoristics.

References

- Alderete, John. To appear. "Dissimilation as Local Conjunction", *NELS* 27.
- Davis, Stuart. 1997a. "A Sympathetic Account of Nasal Substitution in Ponapean Reduplication", *Phonology at Santa Cruz* 5: 15-28.
- Davis, Stuart. 1997b. "The Flowering of Optimality Theory: Ponapean Nasal Substitution and the Problem of Intermediate Forms", Unpublished ms., Indiana University.
- Davis, Stuart. 1996. "Motivating the Syllable. Unpublished ms.", Indiana University.
- Itô, Junko and Armin Mester. 1997. "Prosodic Interludes and Sympathy Effects: Examples from Germanic Phonology". In Viola Miglio and Bruce Morén eds., *University of Maryland Working Papers in Linguistics* 5: 117-138.
- Kenstowicz, Michael. 1994. *Phonology in Generative Grammar*. Cambridge, Blackwell.
- McCarthy, John. 1997. "Sympathy and Phonological Opacity", Paper presented at Hopkins Optimality Theory Workshop/University of Maryland Mayfest 1997.
- McCarthy, John. 1998. "Sympathy and Phonological Opacity". Unpublished ms., University of Massachusetts.
- Smolensky, Paul. 1993. "Harmony, Markedness and Phonological Activity", Paper Presented at Rutgers Optimality Workshop 1, Rutgers University, October 23, 1993.

Seung-Hoon Shin
Dongseo University
Department of English Language and Literature
San69-1, Jurye2-Dong, Sasang-Gu
Pusan, 617-716
The Republic of Korea
e-mail: hoosier@kowon.dongseo.ac.kr

Scrambling in Double Complement Constructions*

Soh, Hooi Ling

University of Michigan/Wayne State University

1. Introduction

Recent studies have shown that object scrambling is available in Chinese (Kung 1993, J.W. Lin 1994, Soh 1998a,b). In this paper, I address the question about the position of the scrambled object. Evidence from the positioning of the object in double complement constructions indicates that the scrambled object appears inside the top VP within a layered VP structure. In particular, the scrambled object is lower than the goal argument in double object and shift constructions, but higher than the goal in dative constructions.

2. Background

Cases that have been argued to show properties of object scrambling in Chinese involve the distribution of the object in relation to duration and frequency phrases (DFPs). For example, certain objects including the demonstrative noun phrase may either precede or follow the duration and frequency phrase (Tang 1990, 1994, Huang 1994b, J.W. Lin 1994).

- (1) a. wo da-le [na yi-ge ren] [liang ci].
 I hit-PERF that one-CL person two time
 'I hit that person twice.'
- b. wo da-le [liang ci] [na yi-ge ren].
 I hit-PERF two time that one-CL person
 'I hit that person twice.'

* I would like to thank Noam Chomsky, Michel DeGraff, Alec Marantz, Shigeru Miyagawa and Ljiljana Progovac for comments and discussions. Thanks are also due to Hai Yong Liu, Jen Ting, Shiao Wei Tham, and Ellen Yuan. This research is funded in part by the Pacific Cultural Foundation (SC7716). All errors are my own.

Other noun phrases such as bare NPs that together with the verb form an activity reading may not precede the DFP (Feng 1995, Kung 1993, Huang 1994b).

- (2) a wo jie-le [yi ci] [zhang].
 I settle-PERF one time account
 'I settled accounts once.' (Feng 1995)
- b. *wo jie-le [zhang] [yi ci].
 I settle-PERF account one time
 'I settled accounts once.' (Feng 1995)

While the positioning of the object in relation to the DFP in Chinese patterns like object scrambling in Dutch and German (see for example Diesing 1992, Neeleman and Reinhart, *In press*, van der Does and de Hoop 1998), it remains controversial whether the different positioning of the object in (1) results from scrambling of the object. There are several logically possible analyses for the relation between (1a) and (1b), some of which have been proposed.

- (3) Logically possible analyses for the relation between [V DFP object] and [V object DFP]:
- I. leftward movement of object (Kung 1993, J.W. Lin 1994)
 - II. rightward movement of object
 - III. leftward movement of DFP (Tang 1990)
 - IV. rightward movement of DFP
 - V. (1a) and (1b) are unrelated (Huang 1994a,b, 1996, Sybesma 1997)

For example, Kung (1993) and J.W. Lin (1994) argue that (1a) is derived from (1b) by moving the object leftward. Alternatively, one can assume that the base order is (1a) and the object moves to the right to derive (1b). One can also imagine that the different word orders arise from moving the DFP rather than the object. It is also possible that (1a) and (1b) are unrelated as Huang (1994a,b, 1996) has proposed.

Soh (1998a,b) provides evidence from scope that supports the leftward object movement analysis. The crucial evidence involves the contrast in the possible scope readings between [V object DFP] and [V DFP object]. When the object precedes the DFP, it may have both wide and narrow scope readings with respect to the DFP as shown in (4). When the object takes wide scope, the relevant reading is that 'for all students, I have invited each of them twice'. When the object takes narrow scope, the relevant reading is that 'there are two times where I have invited all students'.

- (4) wo qing-guo [quanbu de xuesheng] [liang ci].
 I invited-PERF all DE student two time
 'I have invited all students twice.'
 (i) all students >> two times (ii) two times >> all students

When the object follows the DFP, the object may have only the narrow scope reading with respect to the DFP as shown in (5). The reading with the object bearing wide scope is not available.

- (5) wo qing-guo [liang ci] [quanbu de xuesheng].
 I invite-PERF two time all DE student
 'Twice, I have invited all students.'
 (i) ?*all students >> two times (ii) two times >> all students

Assuming the Scope Principle in (6), Soh (1998a,b) argues that the contrast in (4) and (5) indicates that the object is base generated in a position following the DFP and it moves leftward to a position before the DFP as shown in (7).

- (6) The Scope Principle (Aoun and Li 1989: 141)
 A quantifier A has scope over a quantifier B in case A c-commands a member of the chain containing B.
- (7) Leftward movement of the object (Kung 1993, J.W. Lin 1994, Soh (1998a,b)).

Base structure:	Subject	DFP	V	DP	
Derived structures:	(i)	Subject	V _j		DFP t _j DP
	(ii)	Subject	V _j	DP _i	DFP t _j t _i
				↑	└──────────────────┘

The reason why the object preceding the DFP may have both wide and narrow scope readings is because the object c-commands the DFP in its moved position and the DFP c-commands the trace/copy of the object.

- (8) V DP_i DFP t_j order
 all students>>two times because DP_i c-commands DFP
 two times>> all students because DFP c-commands t_j

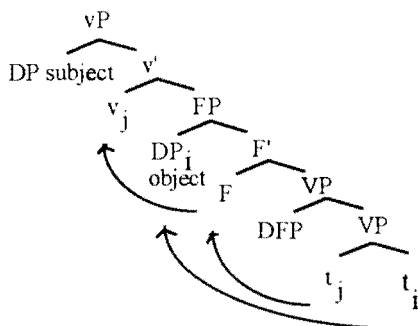

The reason why the object following the DFP can only be interpreted as having narrow scope is because the DFP c-commands the object and there is no point in the derivation in which the object c-commands the DFP.

- (9) [V DFP object] order
 two times >> all students because DFP c-commands DP
 ?*all students >> two times because DP does not c-command DFP

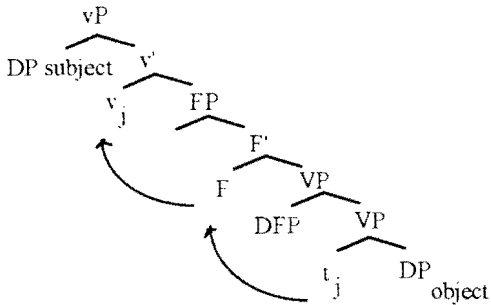

As shown in the structures in (8) and (9), I assume that a transitive sentence involves a double VP structure, where the verb raises to the position of the light verb overtly (Chomsky 1995:315, extending Hale and Keyser's (1993) configuration approach to theta theory, see also Huang 1994a, 1994b, 1996). The external argument appears in [Spec, v] and the DFP adjoins to a VP. I assume that the scrambled object appears in the Spec of a functional projection, which I label FP.¹

3. Where is the Scrambled Object?

3.1 Double complement constructions

There are three types of double complement constructions in Chinese: the dative constructions, the double object constructions and the shift constructions (Kung 1993).

- (10) Types of double complement constructions in Chinese (Kung 1993):
- | | | |
|-------|-----------------------------|------------------|
| (i) | Double object constructions | V goal theme |
| (ii) | Shift constructions | V Gei-goal theme |
| (iii) | Dative constructions | V theme Gei-goal |

¹ See Soh (1998a,b) for discussion on how the other possible analyses listed in (3) do not predict the scope contrast in (4) and (5).

Examples of each type are shown in (11).

- (11) a. wo song-le Zhangsan nei-ben shu. Double object
 I give-PERF Zhangsan that-CL book
 'I have given Zhangsan that book.'
- b. wo song-gei-le Zhangsan nei-ben shu. Shift constructions
 I give-GEI-PERF Zhangsan that-CL book
 'I have given that book to Zhangsan.'
- c. wo song-le nei-ben shu gei Zhangsan. Dative constructions
 I give-PERF that-CL book GEI Zhangsan
 'I have given that book to Zhangsan.'

Double object and shift constructions are unlike dative constructions in where the DFP may appear. For double object and shift constructions, the DFP may appear between the two objects or following the objects, but it may not precede both objects (compare Kung 1993, also see Soh 1998b footnote 5: 167).

- (12) a. wo song-guo Zhangsan **liang ci** na-ben xiao-shuo.
 I give-PERF Zhangsan two time that-CL novel
 'I have given Zhangsan that novel twice.'
- b. ?wo song-guo Zhangsan na-ben xiao-shuo **liang ci**.
 I give-PERF Zhangsan that-CL novel two time
 'I have given Zhangsan that novel twice.'
- c. *wo song-guo **liang ci** Zhangsan na-ben xiao-shuo.
 I give-PERF two time Zhangsan that-CL novel
 'I have given Zhangsan that novel twice.'
- (13) a. ??wo song-gei-guo Zhangsan **liang ci** na-ben xiao-shuo.
 I give-GEI-PERF Zhangsan two time that-CL novel
 'I have given that novel to Zhangsan twice.'
- b. ?wo song-gei-guo Zhangsan na-ben xiao-shuo **liang ci**.
 I give-GEI-PERF Zhangsan that-CL novel two time
 'I have given that novel to Zhangsan twice.'
- c. *wo song-gei-guo **liang ci** Zhangsan na-ben xiao-shuo.
 I give-GEI-PERF two time Zhangsan that-CL novel
 'I have given that novel to Zhangsan twice.'

For dative constructions, the DFP may not appear between the objects but it may appear before or after both objects (see Tang 1994).

- (14) a. *wo song-guo na-ben xiao-shuo **liang ci** gei Zhangsan.
I give-PERF that-CL novel two time GEI Zhangsan
'I have given that novel to Zhangsan twice.'
- b. wo song-guo na-ben xiao-shuo gei Zhangsan **liang ci**.
I give-PERF that-CL novel GEI Zhangsan two time
'I have given that novel to Zhangsan twice.'
- c. (?)*wo song-guo liang ci na-ben xiao-shuo gei Zhangsan.
I give-PERF two time that-CL novel GEI Zhangsan
'I have given that novel to Zhangsan twice.'

The possible placements of the DFP are summarized in (15).

(15) ☑: Possible positions of the DFP ☒: Impossible positions of the DFP

Double object	Shift constructions	Dative constructions
V ☑ DP ☑ DP ☑	V-GEI ☒ DP ☑ DP ☑	V ☑ DP ☒ GEI DP ☑
	V ☑ GEI DP ☑ DP ☑	

3.2 The structures of dative constructions and double object/shift constructions

There is evidence from Chinese for the claim that the double object (and shift constructions) involve one more VP-layer compared to the dative constructions as proposed in Marantz (1993). The evidence involves the contrast between the double object/shift constructions versus the dative construction in the distribution of GE 'each'. This contrast will be discussed below. The structures I assume for the double object construction, the shift construction and the dative construction are shown in (16), (17) and (18) respectively.

(16) Double object constructions

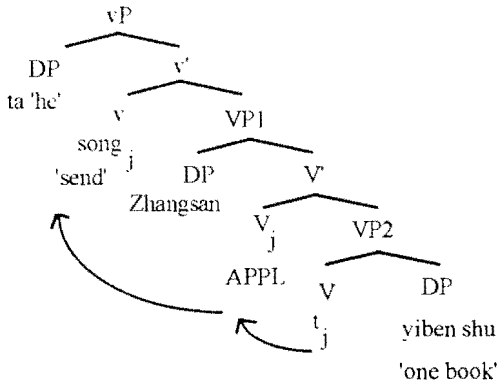

(17) Shift constructions

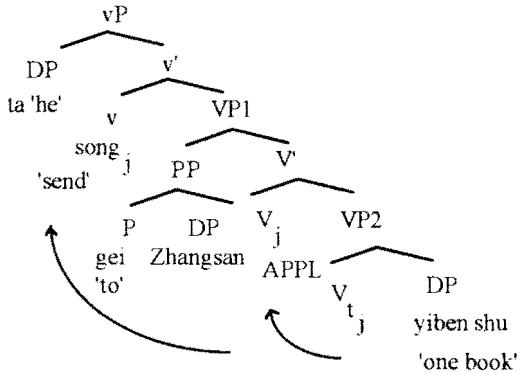

(18) Dative constructions

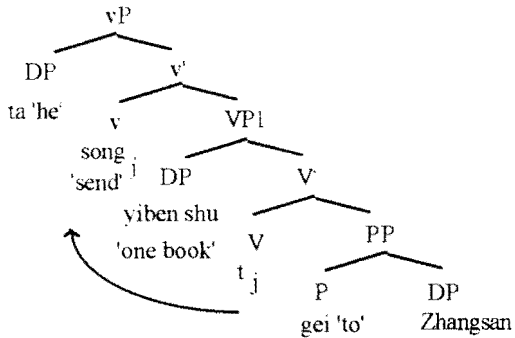

The difference between the double object and shift structures in (16) and (17) versus the dative structure in (18) is that there are two VPs below the light verb in the double object and shift structures, while there is one VP below the light verb in the dative structure. Also, the double object and the shift constructions contain an applicative verb which heads one of the VP.

3.2.1 Evidence from GE 'each'

One piece of evidence for the structural difference between dative versus double object /shift constructions comes from the distribution of GE 'each'. GE 'each' has been referred to as a dyadic quantifier which distributes over two arguments (e.g., Kung 1993). T.H.

Lin (1998) showed that GE adjoins to a VP and it must quantify a distributable argument and bind an indefinite argument.² An example of the use of GE is shown in (19).

- (19) Zhangsan he Lisi ge mai-le wu-ben xiao-shuo. (Kung 1993:117)
 Zhangsan and Lisi GE buy-PERF five-CL novel
 'Zhangsan and Lisi bought five novels each.'

Kung (1993) observed that GE can appear between the two complements in double object and shift constructions, but it cannot appear in between the two complements in dative constructions.

- (20) a. tamen ge song-le Zhangsan wu-ben shu.
 they GE give-PERF Zhangsan five-CL book
 'They gave Zhangsan five books each.' (Kung 1993:118)
- b. Zhangsan song-le nei san-ge ren ge yi-fen liwu
 Zhangsan give-PERF that three-CL person GE one-CL present
 'Zhangsan gave those three people each a present.' (Kung 1993:182)
- c. Zhangsan song gei-le nei san-ge ren ge yi-fen liwu.
 Zhangsan give GEI-PERF that three-CL person GE one-CL present
 'Zhangsan gave those three people each a present.' (Kung 1993:182)
- d. *Zhangsan song-le nei san-fen liwu ge gei er-shi-ge
 Zhangsan give-PERF that three-CL present GE GEI twenty-CL
 ren.
 people (Kung 1993:182)

This observation supports the claim that there is one less VP in dative constructions compared to double object/shift constructions (Marantz 1993). In double object and shift constructions, GE can appear between the internal arguments because there are two VPs in double object/shift constructions. GE can adjoin to the lower VP, VP2 and appears between the internal arguments as shown in (21b) and (22b) for double object and shift constructions respectively.

- (21) a. Zhangsan song-le nei san-ge ren ge yi-fen liwu.
 Zhangsan give-PERF that three-CL person GE one-CL present
 'Zhangsan gave those three people each a present.' (Kung 1993:182)

² In addition to adjunction to a VP, T.H. Lin (1998) proposes that GE can also be adjoined to a V-bar. I do not assume that GE can adjoin to a V-bar because it predicts certain positions for GE which are unattested (see Soh 1998b for some alternative analyses to cases which T.H. Lin (1998) takes as involving GE adjoining to a V-bar).

b. Double object

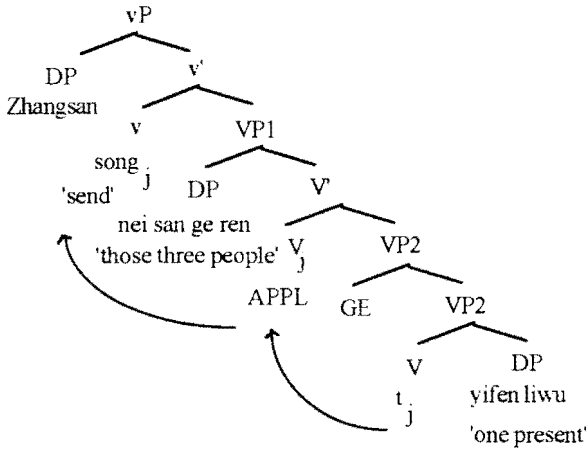

- (22) a. Zhangsan song gei-le nei san-ge ren ge yi-fen liwu.
 Zhangsan give GEI-PERF that three-CL person GE one-CL present
 'Zhangsan gave those three people each a present.' (Kung 1993:182)

b. Shift constructions

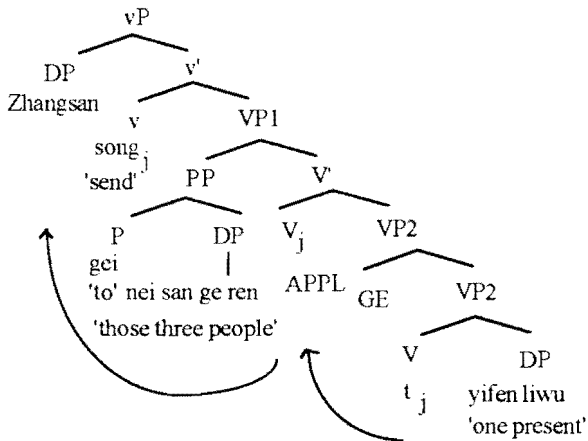

In dative constructions, because there is only one VP and the internal arguments are not separated by a VP boundary, GE 'each', which adjoins to a VP, cannot appear between the internal arguments.

- (23) a. *Zhangsan song-le nei san-fen liwu ge gei er-shi-ge
 Zhangsan give-PERF that three-CL present GE GEI twenty-CL
 ren.
 people (Kung 1993:182)

b. Dative constructions

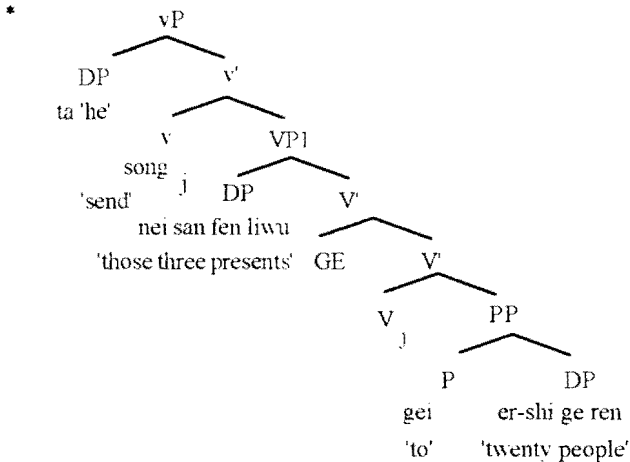

3.3 An analysis of the distribution of the duration/frequency phrase

Before we can address the question about where the scrambled object is, we need to determine to which VP the DFP can be adjoined. There is evidence from serial verb constructions that the DFP may adjoin only to the lowest VP. The DFP may appear before or after the second noun phrase but not before or after the first noun phrase.

- (24) a. ta pai Zhangsan qu-le Meiguo liang ci.
 he send Zhangsan go-PERF US two time
 'He sent Zhangsan (to go) to US twice.'
- b. ta pai Zhangsan qu-le liang ci Meiguo.
 he send Zhangsan go-PERF two time US
 'He sent Zhangsan (to go) to US twice.'
- c. ?*ta pai-le liang ci Zhangsan qu Meiguo.
 he send-PERF two time Zhangsan go US
 'He sent Zhangsan (to go) to US twice.'
- d. ?*ta pai-le Zhangsan liang ci qu Meiguo.
 he send-PERF Zhangsan two time go US
 'He sent Zhangsan (to go) to US twice.'

The possibility of (a) and (b) sentences above suggest that the DFP is adjoined to the lowest VP. I assume that there is a light verb immediately above the lower VP where the lower verb can move to. The structure of SVC assumed is shown in (25).

(25)

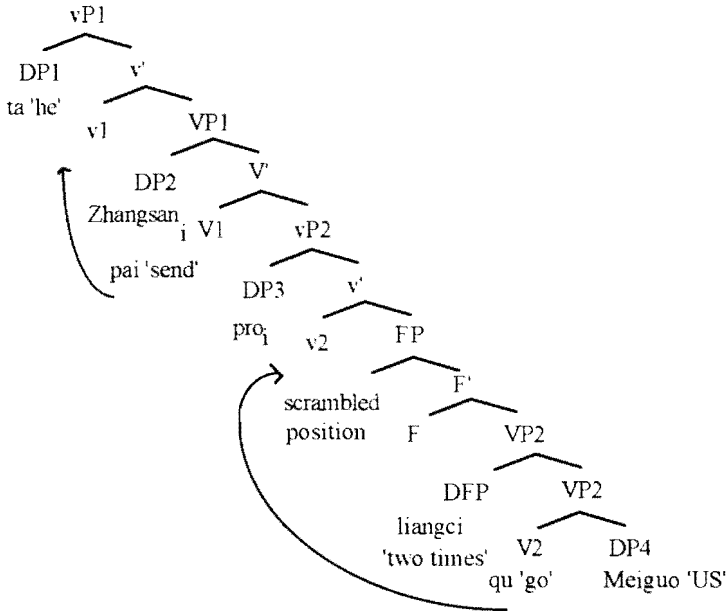

V_2 undergoes head movement to the position of the light verb v_2 . When no further movement occurs, the order in (24b) is derived. When object scrambling occurs, the lower object appears in the scrambled object position above the DFP and the order in (24a) is derived. The fact that (24c) and (24d) are not good indicates that the DFP may only adjoin to the lowest VP and not any other VPs.

3.3.1 Double object and shift constructions

Recall that the DFP may appear before or after the theme, but not before both the theme and the goal. I assume the result above that the DFP adjoins to the lowest VP, VP_2 . Consider the double object structure in (26). After the verb raises to the position of the light-verb, the order [V goal DFP theme] is derived. When the theme moves to the scrambled position before the DFP, the order [V goal theme DFP] surfaces. The order [V DFP goal theme] is not possible because the DFP cannot adjoin to VP_1 in double object constructions and must adjoin to the lowest VP, VP_2 .

(26) Double object constructions

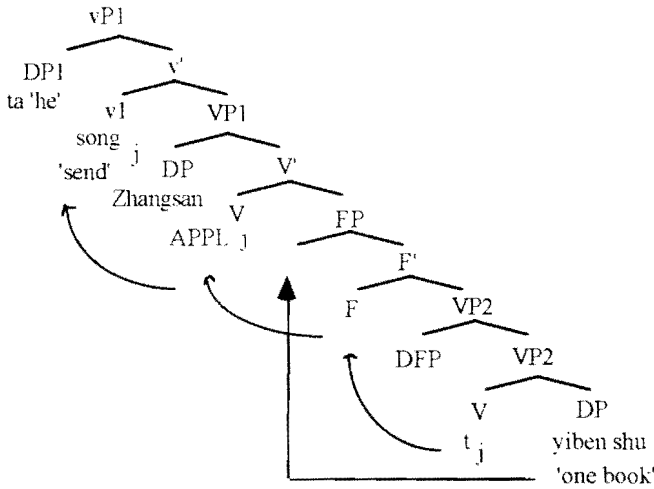

The derivations for the shift construction are the same as the double object construction. The DFP adjoins to VP2, which is the lowest VP. The order [V GEI-goal DFP theme] is derived after the verb undergoes head movement to the position of the light verb. When the theme is moved to the scrambled object position, the order [V GEI-goal theme DFP] is derived. The order [V DFP GEI-goal theme] cannot be derived because the DFP cannot adjoin to VP1 and must adjoin to VP2.

(27) Shift constructions

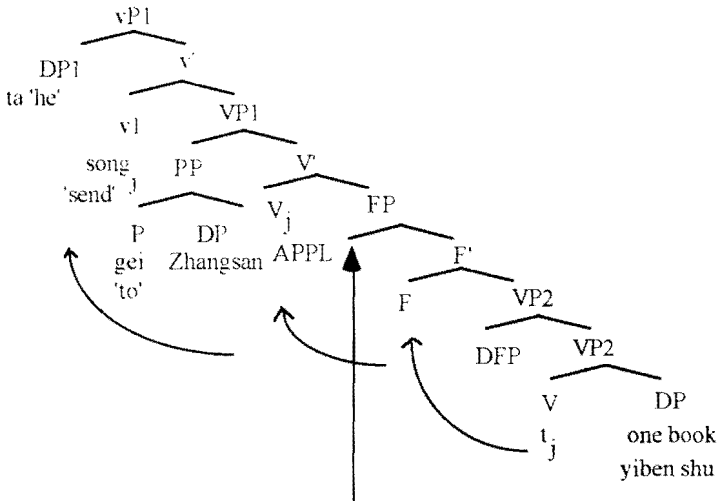

3.3.2 Dative constructions

For the dative construction, the DFP may appear before or after both complements but not in between the complements. The DFP adjoins to the lowest VP, and in this case, the lowest VP is VP1. After the verb raises to the light verb, the order [V DFP theme GEI-goal] is derived.

(28) Dative constructions

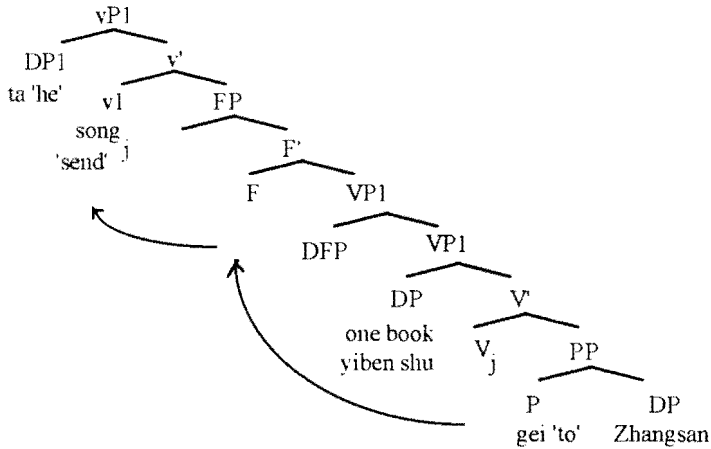

The question is how is the order [V theme GEI-goal DFP] derived? Why can't the theme raise across the DFP leaving behind the goal to derive the unattested form [V theme DFP GEI-goal]? For the first question, two possible analyses come to mind. In one analysis as shown in (29), $VP1$ raises as a whole to the scrambled object position. In another analysis as shown in (30), the theme and the goal raise independently across the DFP.

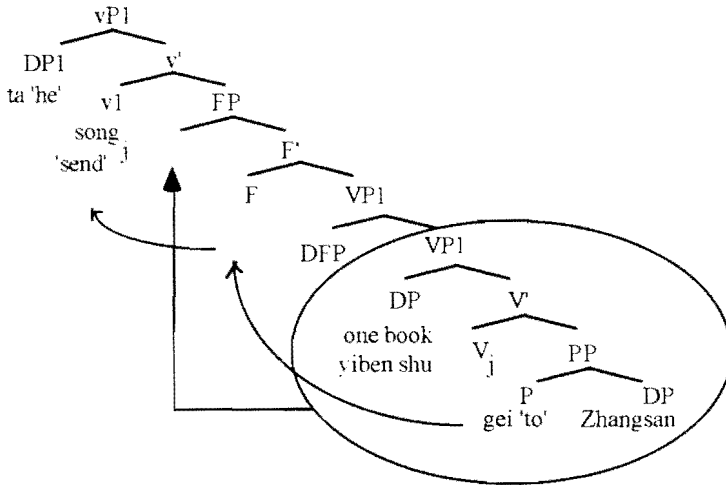
(29) Possible analysis I: VP-raising³

(30) Possible analysis II: Argument raising

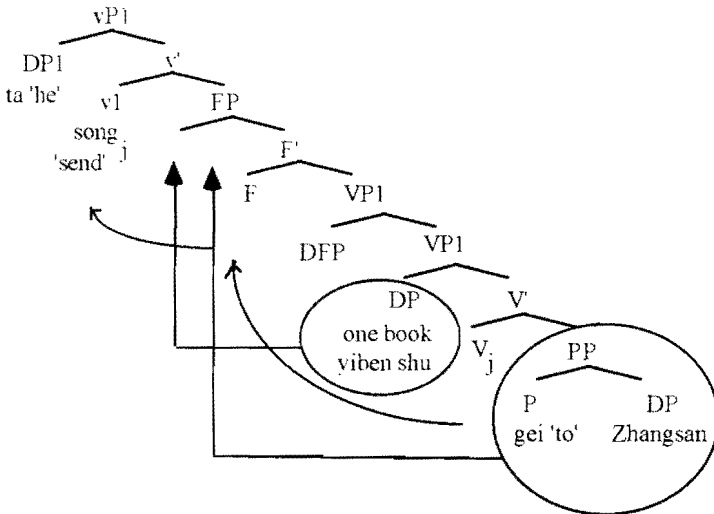

The analysis involving VP-raising provides a straightforward account for the second question, namely why the theme cannot scramble by itself leaving behind the goal. The

³ The problem with raising the bottom part of an adjoined structure can be circumvented if we assume following Cinque (1997) that DFPs appear in the Spec of a functional projection.

reason is that it is the VP (as opposed to the object) which raises (cf. Kung 1993). One problem with this analysis is that if object scrambling in Chinese involves VP-raising which brings along the object, we lose the account of the scope contrast between [V object DFP] and [V DFP object] as discussed in section 2. This is because the raised object which is within the VP does not c-command the DFP. Another problem with positing movement of the VP containing the theme and the goal is that [theme GEI-goal] does not move together in any other context which involves VP movement. In a VP focus context involving *lian...ye* 'even...ye', the [theme GEI-goal] sequence cannot be moved as shown in (31b).

- (31) a. ta lian song na-ben shu gei ta ye bu ken.
 he even give that-CL book GEI him also not willing
 'He is not even willing to give that book to him.'
- b. *ta lian na-ben shu gei ta ye bu ken song.
 he even that-CL book GEI him also not willing give
 'He is not even willing to give that book to him.'

The argument raising analysis allows us to maintain the account for the scope contrast between [V object DFP] and [V DFP object]. It remains unclear why the theme cannot scramble leaving behind the goal in dative constructions. I leave this question for future work.

4. Conclusions

In conclusion, the distributions of the DFP and GE 'each' provide support for the claim that the structures of the double object/shift constructions involve one more VP layer compared to the structure of the dative constructions (Marantz 1993). There is also evidence that the scrambled object in Chinese is within the top VP. It is lower than the goal argument in double object/shift constructions, but higher than the goal argument in dative constructions.

References

- Aoun, Joseph and Y-H Audrey Li. 1989. 'Scope and constituency'. *Linguistic Inquiry*, 20.2: 141-172.
- Chomsky, Noam. 1995. *The Minimalist Program*. Cambridge: MIT Press.
- Cinque, Guglielmo. 1997. *Adverbs and Functional Heads: A Cross-linguistic Perspective*. To be published by Oxford University Press.
- Diesing, Molly. 1992. *Indefinites*. Cambridge: MIT Press.
- Does, Jaap van der and Helen de Hoop. 1998. *Type-shifting and scrambled definites*. Manuscript, Amsterdam/Utrecht.
- Feng, Shengli. 1995. *Prosodic structure and prosodically constrained syntax in Chinese*. Doctoral dissertation, University of Pennsylvania.

- Hale, Kenneth and Samuel Jay Keyser. 1993. 'On argument structure and the lexical expression of syntactic relations', in *The View from Building 20: Essays in Linguistics in Honor of Sylvain Bromberger*. Kenneth Hale and Samuel Jay Keyser (eds.). Cambridge: MIT Press.
- Huang, James. 1982. Logical relations in Chinese and the theory of grammar. Doctoral dissertation, MIT.
- Huang, James. 1994a. 'More on Chinese word order and Parametric Theory', in *Syntactic Theory and First Language Acquisition: Cross Linguistic Perspectives*, B. Lust, M. Suner and J. Whitman (eds.). Lawrence Erlbaum Associates, Inc.
- Huang, James. 1994b. 'Verb movement and some syntax-semantics mismatches in Chinese', *Chinese Languages and Linguistics* 2: 587-613.
- Huang, James. 1996. 'On lexical structure and syntactic projection', to appear in *Chinese Languages and Linguistics* 3
- Kung, Hui I. 1993. The Mapping Hypothesis and postverbal structures in Mandarin Chinese. Doctoral dissertation, University of Wisconsin-Madison.
- Lin, Jo-wang. 1994. 'Object expletives, definiteness effect and scope interpretation', in *Proceedings of the North East Linguistic Society* 24.1. Merce Gonzalez (ed.). University of Massachusetts, Amherst.
- Lin, Tzong-hong. 1998. 'On GE and other related problems', in *The Referential Properties of Chinese Noun Phrases*. Xu, Liejiong (ed.). Collection des Cahiers de Linguistique, Asie Oriental 2. Reg. Recettes Cahiers de Linguistique, Paris.
- Marantz, Alec. 1993. 'Implications and asymmetries in double object constructions', in *Theoretical Aspects of Bantu Grammar 1*. Sam A. Mchombo (ed.). CSLI Publications, Stanford.
- Neeleman, Ad and Tanya Reinhart. In press. 'Scrambling and the PF Interface', in *Projecting from the Lexicon*. W. Gueder and M. Butt (eds). CSLI, Stanford.
- Soh, Hooi Ling 1998a. 'Object scrambling in Chinese: A closer look at post-duration frequency phrase positions', in *Proceedings of NELS 28*. GLSA Publications.
- Soh, Hooi Ling. 1998b. Object scrambling in Chinese. Doctoral dissertation, MIT.
- Sybesma, Rint. 1997. The Mandarin VP. Manuscript, HIL/Leiden University.
- Tang, C.C. Jane. 1990. Chinese phrase structure and the Extended X-bar theory. Doctoral dissertation, Cornell University, Ithaca, New York.
- Tang, C.C. Jane. 1994. 'Conditions on the distribution of postverbal duration and frequency phrases in Chinese revisited', *Chinese Languages and Linguistics* 2: 641-669.

Soh, Hooi Ling
 University of Michigan/Wayne State University
 1076 Frieze Building
 Ann Arbor, MI 48109
 hlsoh@umich.edu

Emergent Unmarkedness: Alternations in Reduplicant *or* Base

Caro Struijke

University of Maryland at College Park

In reduplicated forms, the base and reduplicant are typically entirely identical. Under Correspondence Theory (McCarthy and Prince 1995, within Optimality Theory, Prince and Smolensky 1993), such identity is forced by Base-Reduplicant Faithfulness constraints. Of course, in a theory of violable constraints, sameness of base and reduplicant is not always guaranteed. In particular, considerations of markedness can force one member of the base-reduplicant pair to alternate, resulting in non-identity of the output strings (Steriade, 1988). McCarthy and Prince (1994) dub this state of affairs ‘The Emergence of the Unmarked’ (TETU), and argue that only reduplicants can undergo TETU alternations. This paper shows that it is sometimes the *base* that changes, and introduces a broad interpretation of Input-Output Correspondence to explain this fact.

This broad interpretation of I-O Faithfulness should be seen as ‘Word Faithfulness’. It relates input material to the entire output word, not distinguishing base and reduplicant (Struijke 1997; independently proposed by Raimy and Idsardi 1997; Spaelti 1997; and Yip 1998; cf. I-O Correspondence in McCarthy and Prince (1995) which relates inputs to bases only¹).

(1) *Broad Input-Output Correspondence*

/lexically specified input/

↓

I-O Faithfulness

Reduplicant - Base

(reduplicated) output word

Constraints governing this relation are satisfied if an element in the input is present in the output, be it in the base, reduplicant, or both. Giving these

constraints a high rank in the grammar forces unreduplicated words to be faithful, but allows one member of the reduplicant-base pair to change in response to a lower ranked markedness constraint, resulting in The Emergence of the Unmarked.

Input-Output constraints do not indicate a preference for faithful parsing in the base or reduplicant. Hence, we expect TETU alternations in either output string. Which is faithful to the input, and which undergoes the TETU change is determined either by a markedness constraint (often the constraint driving The Emergence of the Unmarked) or Root Faithfulness (Positional Faithfulness, Beckman 1997). In the former case either the base or the reduplicant can change ('Output TETU'), in the latter only the reduplicant can change, because the base must be faithful ('Reduplicant TETU'). I will illustrate both types of Emergent Unmarkedness with a reduplicative pattern found in the Wakashan language Kwakwala (Boas 1947).

The faithfulness relations relevant for reduplication are given below:

(2) *Reduplicative model of correspondence* (cf. McCarthy and Prince 1995)

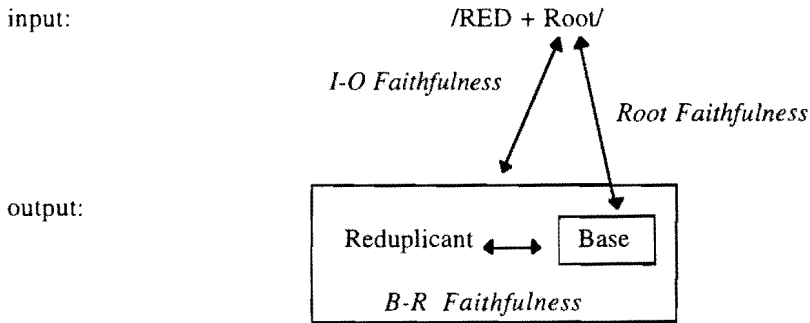

1 TETU Alternations in Base or Reduplicant

The Kwakwala reduplication discussed in this paper co-occurs with certain lexically specified suffixes. The examples that I use contain the suffix /-mu:t/ 'useless refuse'. Reduplicants are prefixal and never exceed the length of a syllable².

These reduplicated words avoid stress clash: heads of feet are not adjacent. When the prefixal reduplicant and /-mu:t/ are concatenated with a root containing a bimoraic initial syllable, both the reduplicant and base-initial syllable are potentially bimoraic, and would form adjacent heads of feet³. Such clash is avoided by deleting a moraic sonorant coda or shortening a vowel⁴. The base-

syllable lightens in trisyllabic forms, whereas the reduplicant-syllable lightens in quadrisyllabic forms.

(3) *TETU alternation in the base*

/RED + wən + mu:t/	(wən)-(wə-mu:t)	'refuse of drilling'
/RED + dəy + mu:t/	(dé:)-(də-mu:t)	'refuse of wiping'
/RED + xəw + mu:t/	(xə:)-(xə-mu:t)	'refuse of splitting wood'

(4) *TETU alternation in the reduplicant*

/RED + sa:q ^w + mu:t/	(sə-sa:)(q ^w ə-mu:t)	'peelings'
/RED + mændz + mu:t/	(mə-mən)(dzə-mu:t)	'remains of kindling'
/RED + q ^w a:l' + mu:t/	(q ^w ə-q ^w á:)(l'ə-mu:t)	'embers'

The constraint penalizing stress clash is active in reduplicated words only. Outside reduplication clash is attested. We find tri- and quadrisyllabic unreduplicated words consisting solely of heavy syllables, each projecting their own foot.

(5) *Clash in unreduplicated words*

(n'e:)(q-o:)(g ^w i:l)	'to intend to say'	*(n'e:)(q-əg ^w i:l)
(gəlt)-(k'o:)(di:ʔ)	'longer one side'	*(gəlt)-(k'ədi:ʔ)
(ts'o:)(l'-əm)(y'a:)	'black cheek'	*(ts'o:)(l'-əy'a:)
(he:)(ʔ-o:)(m'a:)(la:)	'to be in time'	*(həʔ-o:)(m'ala:)
(te:)(n-o:s)(ta:)(la:)	'to pole up river'	*(tən-o:s)(tala:)
(ʔe:)(k'e:x)-(si:)(la:)	'to do because happy'	*(ʔək'e:x)-(səla:)

Apparently, moras and segments present in the input cannot be deleted in unreduplicated words in order to resolve clash: they must be recoverable from the output word. Put differently, Input-Output Faithfulness constraints must dominate the markedness constraint militating against stress clash. This is illustrated in tableaux (9) and (10).

(6) *CLASH: adjacent heads of feet are prohibited (from Hayes 1984; Kager 1994, Kenstowicz 1995, Fitzgerald 1997; cf. Hung 1994).

(7) MAXSEG_{IO}: an input segment must have an output correspondent (McCarthy and Prince 1995)

(8) MAX μ _{IO}: an input mora must have an output correspondent

(9) *No segmental deletion in unreduplicated words*

/ts'o: + 'əmy'a:	MAXSEG _{IO}	*CLASH
1. (ts'o:)(l'-əya: (H)(LH)	* !	
2. ☞ (ts'o:)(l'-əm)(y'a: (H)(H)(H)		* *

(10) *No moraic deletion in unreduplicated words*

/n'e:q + o:g ^w i:l	MAX μ _{IO}	*CLASH
1. (n'e:)(q-əg ^w i:l) (H)(LH)	* !	
2. ☞ (n'e:)(q-o:)(g ^w i:l) (H)(H)(H)		* *

Since Optimality Theory (Prince and Smolensky 1993) assumes a single ranking of constraints to account for all attested phonological forms of a language, a ranking established for unreduplicated words must also allow attested reduplicated words to surface. Since MAXSEG_{IO} and MAX μ _{IO} cannot be violated in Kwakwala unreduplicated forms to satisfy *CLASH, they cannot be violated for that reason in reduplicated forms either. That is, *CLASH can only be satisfied in the optimal reduplicative forms in (3) and (4), if these faithfulness constraints are satisfied also.

I argue that faithfulness constraints are indeed satisfied in reduplicated words, because each input element is parsed in the output: sometimes in the base and sometimes in the reduplicant. The input element that is deleted in one member of the base-reduplicant pair is recoverable from the other. Thus, I assume that Input-Output Correspondence should be seen as a relation between the input and the entire output word (rather than just the base, McCarthy and Prince 1995).

Under this view of Input-Output Faithfulness, the base and reduplicant enjoy equal status. Both are related to input elements via multiple correspondence, as depicted in (11) below.

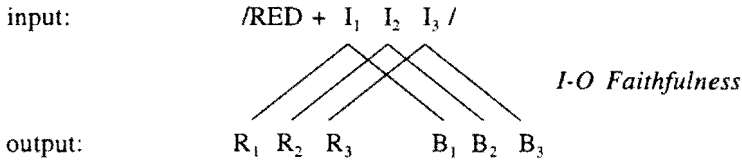
(11) *Multiple Input-Output Correspondence in total reduplication**I = input element, R = reduplicant element, B = base element.*

Since the reduplicative morpheme in the input has no phonological content of its own, it must draw on the phonological contents of other morphemes via correspondence relations in order to be phonologically realized in the output. Apart from the output base, the reduplicant must be in direct correspondence with the lexically specified input. It cannot solely draw on the output base via Base-Reduplicant Correspondence, because it sometimes contains material present in the input, but lost in the base⁵ (see data in (3)).

Input-Output constraints are satisfied if an element in the input has one or more faithful correspondents in the output. In other words, they are satisfied if the unreduplicated word is faithful, and if one or both members of the base-reduplicant pair in a reduplicated word are faithful. Since only one output copy needs to be faithful, the other is free to change in order to satisfy a lower ranked markedness constraint; in this case *CLASH. This is what it means for a markedness constraint to emerge.

1.1 Trisyllabic reduplicated words: changes in the base

In trisyllabic reduplicative forms, a bimoraic root syllable is concatenated with the reduplicative morpheme and /-mu:t/. The heavy root syllable lightens in the base through deletion of the moraic coda sonorant⁶ or shortening of the long vowel/diphthong. The reduplicant is a heavy syllable, retaining the long vowel or coda sonorant.

(12) *Lightening of the base*

/xəw/	(xó:)-(xə-mu:t)	'refuse of splitting wood'
/kən/	(kón)-(kə-mu:t)	'what is left after scooping up'
/qəns/	(qón)-(qas-m'u:t)	'chips'
/qa:s/	(qá:)-(qas-m'u:t)	'tracks'

Even with high-ranking Input-Output constraints, one member of the base-reduplicant pair can surface unfaithfully. In fact, it must, to satisfy lower-ranked *CLASH. As illustrated in tableaux (13) and (14), this markedness constraint

forces base-initial syllables to lighten. Rather than having three (H) feet and two instances of clash in the faithful parse of candidates 1, the base-initial syllable lightens to join the suffixal morpheme in an iambic (LH) foot, as in the optimal candidates 2. The output forms (H)(LH) do not violate MAX-IO constraints or *CLASH, because each segment and mora in the input is faithfully parsed in the output⁷ and heads of feet are not adjacent.

(13) *Lightening of the base to avoid clash (deletion of mora)*

/RED- + dəy+ -mu:t/	MAX μ_{IO}	*CLASH
1. (de:)-(dey)-(mu:t) (H)(H)(H)		**!
2. ☞ (de:)-(də-mu:t) (H)(LH)		

(14) *Lightening of the base to avoid clash (deletion of segment)*

/RED- + kən + -mu:t/	MAXSEG $_{IO}$	*CLASH
1. (kən)-(kən)-(mu:t) (H)(H)(H)		**!
2. ☞ (kən)-(kə-mu:t) (H)(LH)		

*CLASH demands a phonological change in the base only. Lightening of the reduplicant would not avoid clash, as illustrated in tableau (15). Thus, the markedness constraint single-handedly determines the locus of the TETU alternation. Of course, lightening of both the base and the reduplicant is ruled out by high-ranking Input-Output Faithfulness constraints, because an element in the input is not recoverable from the output. Moreover, this candidate (number 3) would not prevent clash.

(15) *CLASH demands only the base to alternate

/RED- + dəy+ -mu:t/	MAX μ_{IO}	*CLASH
1. ☞ (de:)-(də-mu:t) (H)(LH)		
2. (də-de:)-(mu:t) (LH)(H)		*!
3. (də-də)-(mu:t) (LL)(H)	*!	*

In these particular reduplicated words, clash is avoided altogether. However, note that this is not necessarily true of all reduplicated words. *CLASH can only affect elements that are involved in multiple correspondence. More precisely, an output element can only change in The Emergence of the Unmarked if its input mate is in correspondence with another, faithful output element which ensures satisfaction of I-O constraints. Since the size of the Kwakwala reduplicant is one syllable, reduplicants only copy adjacent root material, never suffixal elements. Hence, segments belonging to the input suffix are not involved in multiple correspondence, and have only one chance to surface faithfully in the output. The ranking $\text{MAXSEG}_{10}, \text{MAX}\mu_{10} \gg \text{*CLASH}$ ensures that segments and morae cannot be deleted in suffixes: /RED + wən + gi: sa:we:/ surfaces as (wən)-(wə-gi:)(sa:)(we:), not as *(wən)-(wə-gi:)(sawe:) ‘left over drilling’.

1.2 Quadrisyllabic reduplicated words: changes in the reduplicant

When the morphemes /RED-/ and /-mu:t/ are concatenated with a bimoraic root syllable ending in a laryngeally marked segment, the *reduplicant* lightens to avoid clash.

(16) *Lightening of the reduplicant*

/q ^w a:l'/	(q ^w 'ə-q ^w 'á:)(l'ə-mu:t)	'embers'
/k ^w 'ə ml'/	(k ^w 'ə-k ^w 'əm)(l'ə-mú:t)	'remains of burning'
/mændz/	(mə-mán)(dzə-mu:t)	'remains of cutting kindling'

A voiced obstruent and glottalized sonorant cannot occur in the coda of a Kwakwala syllable (Wilson 1978). As a repair a vowel is epenthesized, and the laryngeally marked segment surfaces in the onset of the newly created syllable. As a result, the reduplicated form is quadrisyllabic, rather than trisyllabic. Since syllable count influences foot structure, quadrisyllabic reduplicant forms have a different foot structure than trisyllabic forms. In particular, the syllable headed by the epenthesized syllable forms a (LH) foot with the suffix, which leaves the potentially heavy base-initial and reduplicant syllables to be footed. If they both surface faithfully, as in candidate 1 of tableau (17), two (H) feet must be created, and stress clash results. Instead, the optimal candidate 2 avoids clash through lightening of the reduplicant, which allows the reduplicant to be footed with the base-initial syllable.

(17) *Lightening of the reduplicant to avoid clash*

/RED- + q ^w a:l' + -mu:t/	MAX _μ _{IO}	*CLASH
1. (q ^w a:)-(q ^w a:)(l'ə-mu:t) (H)(H)(LH)		* !
2. ☞ (q ^w ə-q ^w a:)(l'ə-mu:t) (LH)(LH)		

Again, the markedness constraint decides on the location of the TETU change. Only when the reduplicant alternates are both MAX_μ_{IO} and *CLASH satisfied.

(18) **CLASH demands only the reduplicant to alternate*

/RED- + q ^w a:l' + -mu:t/	MAX _μ _{IO}	*CLASH
1. ☞ (q ^w ə-q ^w a:)(l'ə-mu:t) (LH)(LH)		
2. (q ^w a:)-(q ^w əl'ə)-(mu:t) (H)(LL)(H)		* !
3. (q ^w ə-q ^w ə)(l'ə-mu:t) (LL)(LH)	* !	

1.3 Summary: Output TETU

The emergence of *CLASH in reduplicated words of Kwakwala is an example of TETU in which the markedness constraint involved determines which member of the reduplicant-base pair changes to satisfy its needs. I call this type of TETU 'Output TETU': the emergent markedness constraint can in principle affect either output copy.

The domain of *CLASH includes material from both copies, and therefore demands a phonological change in one only (i.e. an alternation in one satisfies the constraint). Depending on the syllabic structure of the reduplicated form, it is either the base or the reduplicant that changes. Thus, *CLASH does not exhibit a fixed preference for alternations in one string or the other.

Note, however, that markedness constraints involved in Output TETU *can* show a fixed preference. For instance, in a language with prefixal reduplication and initial stress, the reduplicant will receive stress. If a constraint banning full, unstressed vowels emerges in reduplicated forms, only the base will undergo the TETU alternation, simply because it is the only string that contains the marked structure.

Thus, Output TETU can occur when the domain of the relevant markedness constraint includes material from both base and reduplicant (Kwakwala), or if

only one of the output copies contains the marked structure. A third instance of Output TETU occurs when the marked structure is created by concatenation of base and reduplicant. A hypothetical case could involve concatenation of a prefixal reduplicant containing a final nasal with a base whose initial segment is a voiceless consonant. Here the constraint banning such a cluster ($*N\zeta$, Pater 1996) could emerge and force either the base or reduplicant segment to undergo a TETU alternation (e.g. postnasal voicing or nasal deletion, as determined by other constraints in the grammar). Thus, in this case too, the disfavored structure spans the reduplicant-base boundary, and a change in one can make the structure unmarked.

Base-Reduplicant Identity suffers in *The Emergence of the Unmarked*. Hence, B-R constraints must be low-ranking. Of course, Root Faithfulness constraints must be low-ranking also, to allow bases to be unfaithful in Output TETU. We can now provide a general ranking schema for this type of TETU (cf. McCarthy and Prince 1995):

(19) *Output TETU basic ranking*

I-O Faith \gg M \gg B-R Faith, Root Faith

2 Alternations in Reduplicant only: Reduplicant TETU

The constraint *WEIGHTbyPOSITION* (Hayes 1989) emerges in reduplicative forms of Kwakwala also. It demands all coda consonants to be moraic, but is only (fully) active in reduplicants. In bases and unreduplicated words it is (at least partly) inactive.

2.1 Unreduplicated words

In non-reduplicative environments *WEIGHTbyPOSITION* is partially inactive, because obstruents do not contribute to weight. Only sonorant codas must be moraic. This is evidenced by the stress system (Zec 1988). Stress falls on the left-most heavy syllable (18a). Short-vowelled syllables closed by obstruents do not attract stress (18b); those closed by sonorants do (18c).

(20) *non-moraic obstruents in unreduplicated words*

- | | | |
|----|---|-----------------------|
| a. | ha ^{mu} .l'a ^{mu} .ma ^{mu} xs.ta ^{mu} | 'to eat quickly' |
| b. | ga ^{us} .xa ^{mu} | 'to carry on fingers' |
| c. | t'a ^{mu} l's.ta ^{mu} s | 'to eat crabapples' |

The fact that obstruents surface without contributing to weight indicates that it is more important for an obstruent to be non-moraic than to be assigned weight

by position (compare candidates 1 and 2 in tableau (23)). Also, the obstruent must be realized: it cannot delete in order to avoid a violation on WEIGHTbyPOSITION or *OBSTR/ μ (compare candidates 2 and 3)⁸.

(21) *OBSTR/ μ : obstruents are non-moraic (shorthand for * t/μ >> * v/μ , etc.) (Morén, 1997).

(22) WEIGHTbyPOSITION (WxP): Coda consonants must be moraic (Hayes, 1989)

(23) *Obstruents are obligatorily non-moraic*

/CV ^μ O/	* μ /obstr	MAXSEG _{IO}	WxP
1. CV ^μ O ^μ	*!		
2. CV ^μ O			*
3. CV ^μ		*!	

2.2 Reduplicated words

Even though obstruents must be parsed in unreduplicated words, they do not surface in reduplicants of reduplicated words:

(24) *Obstruents do not surface in reduplicants*

/ka:x ^w /	<u>k</u> 'a:-k'ax ^w -m'u:t	* <u>k</u> 'a:x ^w -k'ax ^w -m'u:t	'shavings'
/ts'a:s/	<u>ts</u> 'a:-ts'əs-m'u:t	* <u>ts</u> 'a:s-ts'əs-m'u:t	'old eel-grass'
/te:t/	<u>te</u> :-taɪ-m'u:t	* <u>te</u> :i-taɪ-m'u:t	'remains of bait'
/xəlt/	<u>xə</u> l-xat-m'u:t	* <u>xə</u> lt-xat-m'u:t	'sawdust'

Apparently, reduplicants do not allow non-moraic consonants in coda. WEIGHTbyPOSITION emerges in reduplication, and must be satisfied in reduplicants.

Given the constraint ranking established for unreduplicated words, it is not surprising that one member of the reduplicant-base pair is unfaithful to the input. This can be seen in tableau (25). With high-ranking MAXSEG_{IO} the input obstruent only needs to be parsed in the reduplicated word once. Two parsed obstruents would satisfy this constraint also, but both obstruents would need to be non-moraic (*OBSTR/ μ >> WxP). One parsing of the obstruent incurs one violation of WEIGHTbyPOSITION, two parsings incur two such violations. Thus, this lower-ranked markedness constraint ensures that the obstruent is parsed into the reduplicated form once, rather than twice.

(25) *WxP is active in reduplicated forms*

/RED + ka ^μ x ^w + mu ^μ t/	*μ/obstr	MAXSEG _{IO}	WxP
1. $\text{k}'\text{a}^{\mu}\text{-k}'\text{a}^{\mu}\text{x}^{\text{w}}\text{-}\dots$	✓	✓	*
2. $\text{k}'\text{a}^{\mu}\text{x}^{\text{w}}\text{-k}'\text{a}^{\mu}\text{x}^{\text{w}}\text{-}\dots$	✓	✓	**!

However, neither Broad I-O constraints, nor WxP indicate a preference for the locations of faithfulness and alternation. Neither can determine which output copy is faithful, and which shows the phonological change.

(26) *Candidates with alternations in either member of the BR-pair perform equally on WxP and Broad I-O constraints*

/RED + ka ^μ x ^w + mu ^μ t/	MAXSEG _{IO}	WxP
1. $\text{k}'\text{a}^{\mu}\text{-k}'\text{a}^{\mu}\text{x}^{\text{w}}\text{-}\dots$		*
2. $\text{k}'\text{a}^{\mu}\text{x}^{\text{w}}\text{-k}'\text{a}^{\mu}\text{-}\dots$		*

Root Faithfulness constraints ensure that the base is faithful, rather than the reduplicant. As can be seen in tableau (28), the marks incurred by the optimal candidate form a subset of the marks incurred by candidate 2. For this reason it is irrelevant where Root Faithfulness constraints are ranked with respect to the other constraints at hand. Candidate 2 is harmonically bound by candidate 1: no ranking will make candidate 2 optimal.

(27) MAXSEG_{ROOT}: Every segment in the input root has a correspondent in the output base

(28) *Emergence of the Unmarked in the reduplicant*

/RED + ka ^μ x ^w + mu ^μ t/	MAXSEG _{IO}	WxP	MAXSEG _{ROOT}
1. $\text{k}'\text{a}^{\mu}\text{-k}'\text{a}^{\mu}\text{x}^{\text{w}}\text{-}\dots$		**	
2. $\text{k}'\text{a}^{\mu}\text{x}^{\text{w}}\text{-k}'\text{a}^{\mu}\text{-}\dots$		**	*!

2.3 Summary: Reduplicant TETU

The domain of WxP is relatively small, in the sense that it does not include material from both the base and the reduplicant. Rather, each separately falls within the domain of the constraint. Each is therefore subject to it individually, and the markedness constraint demands an alternation in both. With high-ranking I-O constraints, however, one needs to be faithful. Root Faithfulness constraints ensure that bases are faithful and reduplicants change.

Again, BR-constraints must be low-ranking, otherwise the unmarked would not be able to emerge in reduplicated words. The following two rankings can obtain Reduplicant TETU.

(29) *Reduplicant TETU Ranking (cf. Full Model, McCarthy and Prince 1995):*

I-O Faith >> M >> B-R Faith	(Root Faith irrelevant)
Root Faith >> M >> B-R Faith	(I-O Faith irrelevant)

3 Conclusion

In this paper I have shown that The Emergence of the Unmarked (McCarthy and Prince 1994) can take place in reduplicated words, provided that input material lost in one part of the output is recoverable from the other part. It is because input elements are in multiple correspondence with both the base and the reduplicant via Input-Output Faithfulness, that one of them can change without violating constraints that govern this type of faithfulness. Under this interpretation of Input-Output Faithfulness, base and reduplicant enjoy equal status, and hence either can undergo the phonological change demanded by the emergent markedness constraint.

If the emergent markedness constraint demands an alternation in only one member of the base-reduplicant pair, 'Output TETU' obtains. If it demands an alternation in both, 'Reduplicant TETU' obtains. In Reduplicant TETU the optimal candidate with a change in the reduplicant harmonically bounds the candidate with a change in the base, because the latter has a superset of the violations accumulated by the former: it fatally violates Root Faithfulness constraints.

Whether a markedness constraint demands an alternation in both members of the base-reduplicant pair, or only one, is not intrinsic to the constraint involved. In fact, it mostly depends on the interaction of the constraint's domain size and the size of the reduplicant. For instance, in a language with disyllabic reduplicants, *CLASH may demand alternations in both the base and the reduplicant. Hence, it would be involved in Reduplicant TETU, rather than Output TETU, as in Kwakwala.

Since Input-Output correspondence constraints are satisfied when only one of the output correspondents is faithful to the input element, The Emergence of the Unmarked must take place in reduplicated words, unless constraints demanding identity between base and reduplicant are high-ranking. In other words, only B-R Faithfulness constraints can enforce total and faithful reduplication.

The view expressed in this paper is different from the one put forward by McCarthy and Prince (1995). They assume that Input-Output correspondence

relates the input to the unreduplicated word or the base in the reduplicated word. For this reason one would not expect to find faithful unreduplicated words and unfaithful bases within one language, as in Kwakwala reduplication. Rather, McCarthy and Prince only predict TETU alternations in reduplicants. In most reported TETU cases, it is indeed the reduplicant that alternates. I argue, however, that the existing literature merely reflects a tendency, resulting from Positional Faithfulness (Beckman 1997): bases are subject to both I-O and Root Faithfulness constraints, and are therefore more likely to be faithful to the input than reduplicants. Regardless of this tendency, a broad interpretation of Input-Output Correspondence captures the fact that bases are also able to alternate in TETU.

Notes

1. McCarthy and Prince (1995) suggest a separate Faithfulness relation between the input and the reduplicant (I-R Correspondence), to account for languages in which reduplicants can be more faithful to the input than bases in 'normal application'.
2. I assume that reduplicant size is the result of emerging 'size restrictor' constraints (Spaelti, 1997).
3. Kwakwala exhibits an iambic stress system: (Rodier 1989), and therefore allows the following right-headed feet (L = light syllable, H = heavy syllable): (LH), (H), (LL) (McCarthy and Prince 1986, et seq.; Hayes 1987).
4. When the root-initial syllable is light, the reduplicant is not phonologically realized if it would create clash (Struijke 1997).
5. The B-R relation remains crucial to account for under and overapplication, as well as total and faithful reduplication (McCarthy and Prince 1995).
6. Obstruent codas are not deleted in the base since they do not contribute to weight (Zec 1988). Section 2 will explain why obstruents cannot surface in codas of reduplicants.
7. Since vowel length is (at least sometimes) contrastive in Kwakwala, the input must contain moras associated with the vowels. Consonant weight, however, is entirely predictable. Therefore we cannot make any claims about the presence or absence of coda moras in the input. For ease of exposition I assume that input consonants do not bear moras.
8. For reasons of space I only provide ranking arguments for obstruent codas. In order to achieve compulsory moraic coda sonorants in both reduplicated and unreduplicated words, the following constraint ranking is needed: MAXseg-IO, WxP >> *μ/son.

References

- Beckman, Jill. 1997. *Positional Faithfulness*. Ph.D. Dissertation, University of Massachusetts, Amherst.

- Boas, Franz. 1947. Kwakiutl grammar with a glossary of the suffixes. *Transactions of the American Philosophical Society*. New Series, Vol. 37, part 3, Philadelphia.
- Fitzgerald, Colleen. 1997. *O'odham Rhythms*. Ph.D. Dissertation, University of Arizona, Tucson.
- Hayes, Bruce. 1984. The Phonology of Rhythm in English. *Linguistic Inquiry*, 15. 33-74.
- Hayes, 1987. A Revised Parametric Metrical Theory. Proceedings of NELS 17, ed. by J. McDonough and B. Plunkett. Amherst: University of Massachusetts Graduate Linguistic Student Association.
- Hayes, Bruce. 1989. Compensatory Lengthening in Moraic Phonology. *Linguistic Inquiry*, 20. 253-306.
- Hung, Henrietta. 1994. The Rhythmic and Prosodic Organization of Edge Constituents. Ph.D. Dissertation, Brandeis University, Waltham.
- Kager, René. 1994. Ternary Rhythm in Alignment Theory, ms. Rijksuniversiteit Utrecht.
- Kenstowicz, Michael. 1995. Base-Identity and Uniform Exponence: Alternatives to Cyclicity, ms. Massachusetts Institute of Technology.
- McCarthy, John, and Alan Prince. 1986. Prosodic Morphology. Ms., University of Massachusetts, Amherst, and Brandeis University, Waltham.
- McCarthy, John & Alan Prince. 1994a. The Emergence of the unmarked: Optimality in Prosodic Morphology, in Merce Gonzalez (ed.). *Proceedings of the North-East Linguistic Society*, 24. Amherst: Graduate Linguistic Student Association, pp. 333-379.
- McCarthy, John & Alan Prince. 1994b. *An overview of Prosodic Morphology: Parts I and II*. [Talks presented at the OTS/HIL Workshop on Prosodic Morphology, Utrecht].
- McCarthy, John & Alan Prince. 1995. Faithfulness and Reduplicative Identity. *University of Massachusetts occasional Papers in Linguistics*, 18: *Papers in Optimality Theory*. 249-384.
- Móren, Bruce. 1997. *Markedness and Faithfulness Constraints on the Association of Moras: Vowel Length and Consonant Weight in Three English Dialects*. Paper presented at HOT-97/Maryland Mayfest, Baltimore.
- Pater, Joe. 1996. Austronesian Nasal Substitution and other NÇ Effects. Ms, McGill University [ROA]. (to appear in Kager, René, Harry van der Hulst, and Wim Zonneveld (eds.), *The Prosody Morphology Interface*. Cambridge University Press.
- Prince, Alan & Paul Smolensky. 1993. *Optimality Theory: Constraint Interaction in Generative Grammar*. Ms., Rutgers University, New Brunswick, and University of Colorado, Boulder. [To appear as Linguistic Inquiry Monograph, MIT Press, Cambridge, MA.
- Rodier, Dominique. 1989. Prosodic Affixation in Kwakiutl. *Proceedings of the Eastern States Conference on Linguistics (ESCOL)*, 6. 218-228.

- Raimy, Eric and William Idsardi. 1997. A Minimalist Approach to Reduplication in Optimality Theory. Proceedings of the North East Linguistics Society, 27, ed. by K. Kusumoto.
- Spaelti, Philip. 1997. Dimensions of Variation in Multi-Pattern Reduplication. Ph.D. dissertation, University of California, Santa Cruz.
- Steriade, Donca. Reduplication and Syllable Transfer in Sanskrit and Elsewhere. *Phonology* 5. 73-155.
- Wilson, Peter. 1978. Syllable Structure in Kwakwala and Heilstuk. *XIII International Conference on Salishan Languages*. 275-299.
- Yip, Moira. 1998. The Role of Markedness in Onset Change. Proceedings of 'On the Formal Way to Chinese Languages', ed. by C.S. Liu and S.W. Tang. C.S.L.I.
- Zec, Draga. 1988. *Sonority Constraints on Prosodic Structure*. Ph.D. dissertation, Stanford University (1994, New York: Garland).

Caro Struijke
University of Maryland
Dept. of Linguistics
1401 Marie Mount Hall
College Park, MD 20740
cstruyke@wam.umd.edu

Multiple Wh-Questions and the Unique Specifier Position Hypothesis*

Hidekazu Tanaka

McGill University

Saito (1994) and Watanabe (1991) observe that Japanese multiple wh-questions permit the sequence *'what why.'* but not *'why what.'* Thus, we have the following contrast.

- (1) a. John-ga nani-o naze naosita-no?
John-Nom what-Acc why fixed -Q
b. * John-ga naze nani-o naosita-no?
John-Nom why what-Acc fixed -Q
'Why did John fix what?'

The ungrammaticality of (1b) seems to share some syntactic properties in common with the ungrammaticality of (2), which shows that multiple adjunct wh-questions are impossible.

- (2) *John-ga naze kuruma-o dou naosita-no?
John-Nom why car-Acc how fixed -Q
'Why and how did John fix the car?'

Both (1b) and (2) improve substantially when extra wh-phrases are added in a higher position (higher wh-effect). (3a) and (3b) constitute a minimal pair with (1b) and (2), respectively.

- (3) a. **Dare-ga** naze nani-o naosita-no?
who-Nom why what-Acc fixed -Q
'Who fixed what why?'

- b. **Dare-ga naze nani-o dou naosita-no?**
 who-Nom why what-Acc how fixed -Q
 'Who fixed what how and why?'

This article proposes an account of the ungrammaticality of (1b) and (2). The analysis also captures the higher wh-effect shown in (3). It is claimed that a functional category in Japanese can have at most one specifier position. For this reason, in multiple wh-questions in Japanese, all wh-phrases taking the same scope must amalgamate prior to LF-movement to the [+wh] CP-Spec. Thus, multiple wh-questions in this language have the following structure at LF.

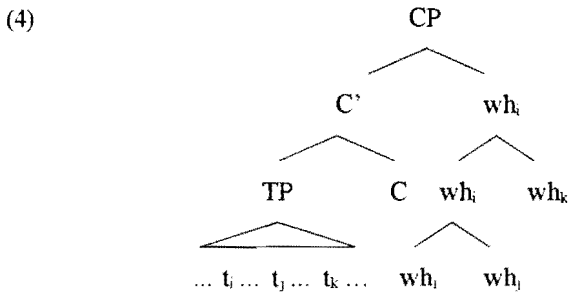

Section one shows that wh-phrases taking the same scope form a syntactic constituent. Section two develops an account of (1b) and (2). Section three demonstrates that the same mechanism that accounts for (1b) also accounts for the higher wh-effect. Section four provides additional evidence for the proposed analysis of wh-questions based on their interaction with floating quantifiers.

1 Amalgamation

(5a) has a wh-phrase within a wh-island. As observed by Nishigauchi (1990), the sentence is marginal. We are not concerned with (5a) (cf. Tanaka (to appear)). (5b) shows that scrambling out of a wh-island is permissible. In fact, when the wh-phrase is scrambled, we get a perfectly grammatical sentence.

- (5) a. ??Mary-ga [John-ga nani-o naosita-kadooka] kiita-no?
 Mary-Nom [John-Nom what-Acc fixed whether] asked-Q

- b. Nani-o_i Mary-ga [John-ga t_i naosita-kadooka]
 what-Acc, Mary-Nom [John-Nom t_i fixed whether]
 kiita-no?
 asked-Q
 ‘What_i did Mary ask whether John fixed t_i?’

(6a) and (5a) are marginal for the same reason that we are not concerned with. (6b) shows that an adjunct wh-phrase, *naze* (why), cannot scramble long-distance, unless accompanied by a preceding argument wh-phrase as in (6c).

- (6) a. ?? Mary-ga [John-ga nani-o naze naosita-kadooka]
 Mary-Nom [John-Nom what-Acc why fixed whether]
 kiita-no?
 asked-Q
 ‘What_i did Mary ask whether John fixed t_i why?’
- b. ** Naze_i Mary-ga [John-ga nani-o t_i naosita-kadooka]
 why_i Mary-Nom [John-Nom what-Acc t_i fixed whether]
 kiita-no?
 asked-Q
 ‘Why_i did Mary ask whether John fixed what t_j?’
- c. Nani-o_j naze_i Mary-ga [John-ga t_j t_i naosita-kadooka]
 what-Acc, why_i Mary-Nom [John-Nom t_j t_i fixed whether]
 kiita-no?
 asked-Q
 ‘What_i and why_j did Mary ask whether John fixed t_i t_j?’

To account for (6b), I tentatively assume (7) as a descriptive generalization.

- (7) Adjuncts cannot be moved by scrambling.

Given (7), the adjunct wh-phrase in the second position of (7c) does not occupy its surface position as a result of scrambling, since, otherwise, (7c) would be as ungrammatical as (7b). If the adjunct wh-phrase amalgamate first with the argument wh-phrase, and then the two wh-phrases scramble as a unit, (7c) is correctly expected to be grammatical on a par with (5b).

There is another piece of evidence that *wh*-phrases form a unit. The two *wh*-phrase in (1a) can be the focus of a cleft sentence (cleft constructions with multiple foci are in general impermissible).

- (8) John-ga $t_i t_j$ naosita-no-wa [nani-o, naze_j] datta-no?
 John-Nom $t_i t_j$ fixed thing-Top [what-Acc_i why_j] Cop -Q
 ‘What_i and why_j was it that John fixed $t_i t_j$?’

Based on (6) and (8), I conclude that *wh*-phrases taking the same scope become a constituent in Japanese. In particular, (6) and (8) show that *wh*-phrases may amalgamate in overt syntax, since both scrambling and clefting, which apply after amalgamation of *wh*-phrases, are overt operations. The question, then, is how *wh*-phrases come to form a constituent.

2 ω P and Amalgamation

So far, I have argued for (9).

- (9) *wh*-phrases taking the same scope amalgamate prior to LF-movement.

In addition, I argue that the following propositions are valid.¹

- (10) a. *wh*-phrases are dominated by a functional projection, ω P.
 b. Checking takes place between ω and ω , or ω and Q-Comp.
 c. *naze* (why) in (1b) is in the ω P-Spec of the preceding argument *wh*-phrase.
 d. Specifiers are sub-set of adjunction: Specifiers, but not adjuncts, agree with a head. (Fukui and Saito (1998))
 e. Adjuncts can only move when they agree with a head ((7)).

Given these assumptions, (1b) is derived in the manner shown in (11).

- (11) a. John-Nom [ω what-Acc] why fixed-Q
 b. John-Nom [ω [ω what-Acc] why_i] t_i fixed-Q
 c. John-Nom $t_j t_i$ fixed-Q- [ω [ω what-Acc] why_i]

why first adjoins to the preceding argument *wh*-phrase and agrees with (and check its [+wh] feature against) the ω^0 to become a specifier. I assume that specifiers are on the right in Japanese (see Tanaka (1997)). The two *wh*-phrases form a constituent and can move to the specifier position as a unit.

Let us consider how the proposed analysis accounts for (1b) and (2). Their English glosses are reproduced in (12) for reference.

- (12) a. * John-Nom **why** *what-Acc* fixed-Q (= (1b))
 ‘Why did John fix what?’
 b. *John-Nom **why** *car-Acc* *how* fixed-Q (= (2))
 ‘Why and how did John fix the car?’

To account for these sentences, I assume (13).

- (13) Adjunction to an A'-item is precluded.

Given (13), the lower wh-phrase in (12) cannot adjoin to the higher one, which is an A'-item. Thus, the two wh-phrases cannot form a unit and fail to move to the [+wh] CP-Spec at LF.

(13) also accounts for the following contrast, observed by Takahashi (1993).

- (14) a. Dare-ga [Mary-ga nani-o tabeta-to] itta-no?
 who-Nom [Mary-Nom what-Acc ate Comp] said-Q
 ‘Who said that Mary ate what?’
 b. ?* Nani-o_i dare-ga [Mary-ga t_i tabeta-to] itta-no?
 what-Acc_i who-Nom [Mary-Nom t_i ate Comp] said-Q
 ‘What did who say that Mary ate?’

Takahashi argues that the scrambled wh-phrase in (14b) cannot be undone (cf. Saito (1992)). The matrix subject wh-phrase therefore has to adjoin to the higher wh-phrase, but this is not possible, since long-distance scrambling is an A'-adjunction (Saito (1992)). The two wh-phrases in (14b) cannot form a unit. On the other hand, the embedded object wh-phrase in (14a) can adjoin to the matrix wh-phrase, since the higher wh-phrase occupies an A-position.

3 Higher wh-Effect

The higher wh-effect sketched in the introduction can be deduced to the proposed framework. The schematic structure of the relevant examples are reproduced in (15) with slight modifications.

- (15) a. [**who-Nom** *why_i*] t_i what-Acc fixed-Q (= (3a))
 ‘Who fixed what why?’

- b. [**who-Nom** *why_i*] t_i [**what-Acc** *how_j*] t_j fixed-Q (= (3b))
 ‘Why and how did who fix what?’

In each of these cases, the additional wh-phrases in bold-face can have an adjunct wh-phrase in its specifier position as shown in the examples. Once the derivation reaches this point, these sentences are no different from multiple wh-questions with two argument wh-phrases, such as ‘Who fixed what?’ and the rest of their derivation mimics that of this sentence.

(16) constitutes a minimal pair with (15b). (16) has only one additional wh-phrase.

- (16) ?* [**Dare-ga** *naze_i*] t_i kuruma-o *dou* naosita-no?
 [who-Nom *why_i*] t_i car-Acc how fixed -Q
 ‘Who and why and how fixed the car?’

In contrast to (15b), (16) is ungrammatical. This is expected if the ω P that dominates the additional wh-phrase can have at most one specifier, and hence the lowest wh-phrase cannot be a part of the complex of the wh-phrases, and hence fails to take scope at LF. Thus, I assume (17).

- (17) A functional head can have at most one specifier.

(17) follows if agreement is bijective. (17) also automatically derives one of our assumptions in (9). The wh-phrases taking the same scope must form a unit prior to LF-movement to the [+wh] CP-Spec, since there is only one specifier for a [+wh] C⁰.

4 Free Ride

The sentence in (18) is far less grammatical than (2).

- (18) ** John-ga dou kuruma-o naze naosita-no?
 John-Nom how car-Acc why fixed -Q
 ‘How and why did John fix the car?’

I assume that the extra serious ungrammaticality of (18) arises from the general sequential constraints on adverbs: a VP adverb cannot precede a S-adverb. The minimally contrasting pair in (19) is a case in point.

- (19) a. John-ga odoroitakotoni isoide syorui-o seiri-sita.
 John-Nom surprisingly hurriedly document-Acc sorted-out
 ‘Surprisingly, John hurriedly sorted out the documents.’

- b. *John-ga isoide odoritakotoni syorui-o seiri-sita.
 John-Nom hurriedly surprisingly document-Acc sorted-out
 'Hurriedly, John sorted out the documents surprisingly.'

If *dou* (how) is a VP-adverb and *naze* (why) a S-adverb, as seems reasonable to hold, the extra serious ungrammaticality of (18) can be ascribed to the condition that makes (19b) ungrammatical.

Interestingly, it is not always the case that *dou* cannot follow *naze*. (20) is grammatical.

- (20) Nani-o *dou* dare-ga naze naosita-no?
 what-Acc how who-Nom why fixed -Q
 'Why and how did who fix what?'

This fact also follows from the present analysis. (20) is derived as in (21).

- (21) a. who-Nom why what-Acc how fixed-Q
 b. [who-Nom why_i] t_i [what-Acc how_j] t_j fixed-Q
 c. [what-Acc how_j]_k [who-Nom why_i] t_k t_j fixed-Q

The adjunct wh-phrases in (21a) adjoin to the ω' that dominates the argument wh-phrases and become their specifiers. The lower two wh-phrases in (21b) form a constituent and therefore can scramble across the higher wh-phrases, as shown in (21c). (21c) can then be treated in the same way as (22).

- (22) Nani-o_i dare-ga t_i naosita-no?
 what-Acc_i who-Nom t_i fix -Q
 'What did who fix?'

In (22), the lower wh-phrase adjoin to the higher one. Since scrambling in this instance is local, the higher wh-phrase is in A-position (Saito (1992)) and hence adjunction is possible. Thus, under our assumptions, *dou* (how) in (20) gets a free ride from the scrambled accusative wh-phrase. Interestingly, referential NPs cannot give a free ride to *dou*.

- (23) *Kuruma-o *dou* dare-ga naze naosita-no?
 car-Acc how who-Nom why fixed-Q
 'Why and how did who fix the car?'

This is also expected under our assumptions. The scrambled referential accusative phrase is not a ω P, and therefore cannot be adjoined to, since it cannot check the wh-feature on *dou*. The sentence therefore violates the sequential constraint on adverbs. Furthermore, the three wh-phrases in (23)

cannot form a constituent, since the highest *wh*-phrase is an adjunct, which cannot be adjoined to by the lower two *wh*-phrases.

5 Some Extensions: Floated Quantifiers

This section shows that the proposed analysis naturally captures the distribution of floated quantifiers. (23) shows that a quantifier out of an object (OFQ) can precede or follow the object phrase.

- (24) a. John-ga sake-o ni-hon nonda.
 John-Nom sake-Acc 2-bottles drank
- b. John-ga ni-hon sake-o nonda.
 John-Nom 2-bottles sake-Acc drank
 'John drank two bottles of sake.'

Similarly, a quantifier floated out of a subject (SFQ) can precede or follow the subject.

- (25) a. Gakusei-ga san-nin sake-o nonda.
 student-Nom 3-people sake-Acc drank
- b. San-nin gakusei-ga sake-o nonda.
 3-people student-Nom sake-Acc drank
 'Three students drank sake.'

I assume that SFQs are S-adverbs and OFQs VP-adverbs. One piece of evidence for this assumption comes from (26), which show that they are subject to the sequential constraint (see (19) above).

- (26) a. Gakusei-ga san-nin ni-hon sake-o nonda.
 student-Nom 3-people 2-bottles sake-Acc drank
- b. *Gakusei-ga ni-hon san-nin sake-o nonda.
 student-Nom 2-bottles 3-people sake-Acc drank
 'Three students drank two bottles of sake.'

(26b) shows that an OFQ cannot precede a SFQ. However, when an OFQ is preceded by the scrambled object phrase, we get a grammatical sentence.

- (27) [Sake-o ni-hon_i]_j gakusei-ga san-nin t_j t_i nonda.
 [sake-Acc 2-bottles_i]_j student-Nom 3-people t_j t_i drank
 'Two bottles of sake, three students drank.'

This fact, which is parallel to the one observed in (20), suggests that the OFQ first adjoins to the object NP and then is scrambled along with the accusative phrase. This in turn implies that floated quantifiers should be treated along the line of analysis presented above: floated quantifiers adjoin to the quantified NPs and become a specifier.

In the (b)-sentences of (24) and (25), floated quantifiers precede the quantified NPs. I argue that quantified NPs move to a higher position than the quantifiers for Case-checking at LF. For instance, the LF representation of (24b) is derived in the following manner.

- (28) a. John-Nom [_{VP} 2-bottles [_{VP} sake-Acc drank]]
 b. John-Nom [_{VP} sake-Acc_i [_{VP} 2-bottles [_{VP} t_j drank]]]
 c. John-Nom [_{VP} [sake-Acc_i 2-bottles_j] [_{VP} t_j [_{VP} t_i drank]]]

(28a) is the S-structure (spell-out) representation of (24b). The accusative NP moves for the purpose of Case-checking. For the purpose of explanation, I assume that accusative NPs are Case-checked in the position adjoined to the VP. The OFQ is in the lower position in (28b) than the accusative NP and therefore can adjoin to the accusative NP and become a specifier of it.

The analysis given above appears to have an undesired consequences for the proposed account of the impossible 'why-what' sequence. Consider (29b) (cf. (1b)).

- (29) a. John-ga nani-o dou naosita-no?
 John-Nom what-Acc how fixed -Q
 'What and how did John fix?'
 b. *John-ga dou nani-o naosita-no?
 John-Nom how what-Acc fixed -Q
 'How and what did John fix?'

If the accusative wh-phrase in (29b) raises to a position higher than *dou*, the two wh-phrases should be able to amalgamate and the sentence should be grammatical on a par with (29a). I argue that the ungrammaticality of (29b) means that ω Ps do not raise for Case-checking. If so, the accusative wh-phrase in (29b) does not raise to a position higher than *dou*. On the other hand, the scrambled accusative wh-phrase is in the higher position than *dou*. We can thus draw the desired distinction.

As evidence that ω Ps do not raise for Case-checking, let us consider (30b), which constitutes a minimal pair with (24b).

- (30) a. John-ga nani-o ni-hon nonda-no?
 John-Nom what-Acc 2-bottles drank -Q
- b. * John-ga ni-hon nani-o nonda-no?
 John-Nom 2-bottles what-Acc drank -Q
 'John drank two bottles of sake.'

The quantified phrase in the lower position than the FQ cannot be a wh-phrase. This fact follows from the proposed analysis. The wh-phrase in (30b) does not raise at LF for Case-checking. For this reason, the OFQ cannot adjoin to the quantified phrase.

(31) shows that an additional wh-phrase remedies the potentially problematic sentence in (30b).

- (31) Dare-ga ni-hon nani-o nonda-no?
 who-Nom 2-bottles what-Acc drank-Q
 'Who drank two bottles of sake.'

This fact also follows from our analysis. (32) is the LF derivation of (31).

- (32) a. who-Nom 2-bottles what-Acc drank-Q
 b. [ω P what-Acc_i [ω P who-Nom]] 2-bottles t_i drank-Q
 c. [[ω P what-Acc_i 2-bottles_j]] [ω P who-Nom]] t_j t_i drank-Q
 d. t_k t_j t_i drank-Q- [[ω P what-Acc_i 2-bottles_j]] [ω P who-Nom]]_k

(32) is the representation at S-structure (spell-out). The lower wh-phrase adjoins to the higher wh-phrase, since wh-phrases taking the same scope amalgamate under the proposed analysis. The OFQ can then adjoin to the quantified wh-phrase in the higher position, as in (32c). The entire complex of the two wh-phrases and the OFQ move to the CP-Spec at LF.

6 Summary

I have shown in this paper that Japanese wh-phrases taking the same scope amalgamate prior to LF-movement to [+wh] CP-Spec. Wh-phrases are dominated by a functional projection, ω P. The ω^0 of the higher wh-phrase checks the wh-feature of the lower wh-phrases. This analysis is supported by the interaction of multiple wh-questions and floated quantifiers. Spec-Head

agreement in a functional projection is bijective, which means that a functional head may have at most one specifier. Floated quantifiers, like adjunct *wh*-phrases in multiple *wh*-questions, adjoin to their quantified NPs. For space limitation, this paper presents only a fragment of a larger paradigm. For more detailed discussion, see Tanaka (1998a, 1998b).

* I would like to thank Mark Baker for comments on earlier versions of this paper. Ileana Paul is thanked for reading this paper at the WECOL '98 conference. All remaining imperfections are imputed to the author.

¹ For independent justification of these propositions, see Tanaka (1998).

References

- Chomsky, Noam. 1995. *The Minimalist Program*, Cambridge, Massachusetts: MIT Press.
- Koizumi, Masatoshi. 1995. *Phrase Structure in Minimalist Syntax*, PhD dissertation, MIT.
- Richards, Norvin. 1997. *What Moves When Where in Which Language?*, PhD dissertation, MIT.
- Saito, Mamoru. 1994. "The additional *wh*-effects and the adjunction site theory," *Journal of East Asian Linguistics* 3, 195-240.
- Saito, Mamoru and Naoki Fukui. 1996. "Order in phrase structure and movement," *Linguistic Inquiry* 29, 439-474.
- Takahashi, Daiko. 1993. "Movement of *wh*-phrases in Japanese," *Natural Language and Linguistic Theory* 11, 655-678.
- Tanaka, Hidekazu. 1997. "Invisible movement in *sika-nai* and the linear crossing constraint," *The Journal of East Asian Linguistics* 6, 143-188.
- Tanaka, Hidekazu. 1998a. *Conditions on Logical Form Derivations and Representations*, PhD dissertation, McGill University.
- Tanaka, Hidekazu. 1998b. "Syntax of adjunction, specifiers, and adjunct phrases," ms., McGill University, Montreal, Quebec.
- Tanaka, Hidekazu. to appear. "LF *wh*-Islands and the minimal scope principle"

Natural Language and Linguistic Theory.

Ura, Hiroyuki. 1996. *Multiple Feature-Checking: a Theory of Grammatical Function Splitting*, PhD dissertation, MIT.

Watanabe, Akira. 1991. (*Wh*-in-situ, subjacency, and chain formation, ms., MIT.

Hidekazu Tanaka
Department of Linguistics
McGill University
1001 Sherbrooke West
Montreal, Quebec
H3A 1G5 CANADA
htanak@po-box.mcgill.ca

An Aspectual System in Language Shift: A Case Study of Baba Malay

Elzbieta Thurgood

California State University, Fresno

1 Introduction*

The Baba Malay aspectual system was developed in the process of language shift, in the course of which Hokkien speakers shifted to Malay. This paper provides an analysis of the Baba Malay aspectual system, compares it with the aspectual systems found in Hokkien (the language shifted from) and Malay (the language shifted to), and looks at the implications of the findings for the study of language shift.

In this paper, the Baba Malay aspectual system is analyzed as a discourse-related phenomenon, one in which aspectual markers correlate with the discourse structure of the narrative. The theoretical framework for the analysis of the discourse structure adopted here is that of Labov and Waletzky (1967). Within their framework events are divided into foregrounded events and backgrounded events. The foregrounded events report what happened next in the story. The backgrounded events report other information, most of which is typically useful for understanding the narrative. In order to understand a narrative, it is crucial for the reader (or the listener) to be able to keep track of which events are foregrounded and which are backgrounded. In Baba Malay, the aspectual system is central to differentiating between events in the foreground and events in the background.

This study shows that the Baba Malay aspectual system consistently uses two overtly-marked aspectual categories — the progressive and the perfect. The progressive encodes the reported event as ongoing and thus incomplete. The perfect encodes “result, ‘current relevance’, completion” (Brinton 1988:7). The perfect has to be differentiated from the perfective as both terms deal with different aspectual distinctions. Thus, while the perfect tells us nothing directly about the event itself, but rather relates it to other events (Comrie 1976:52), the perfective tells us a lot about the event itself by marking it as a completed event, “with beginning, middle, and end” (Comrie 1976:18).

1.1 Database

The database for this study consists of five narrative stories published in the Baba Malay daily newspaper *Bintang Timor* between July 27, 1894 and April 11, 1895. These stories are: (1) *Cherita dua orang adek beradek* (CDO) 'The story of two siblings', (2) *Cherita deri hal mak tiri dengan anak tirinya* (CDHMT) 'A story about a stepmother and her stepchild', (3) *Orang miskin yang datang ka Singapura* (OM) 'Poor people who come to Singapore', (4) *Putri yang chinta bapanya sperti garam* (PYC) 'About the princess who loved her father like salt', and, (5) *Smoa pun baik jikalau penghabisannya baik* (SPB) 'All's well that ends well'. These narratives constitute a database of over 10,000 words. The database also includes a collection of dialogues titled *A manual of the Malay colloquial, such as is spoken by all nationalities in the Colonies of the Straits Settlements, and designed for domestic and business purpose* by Lim Hiong Seng (1887).

The Baba Malay database is compared with Malay of the same century, including the descriptions of two prominent nineteenth century grammarians, Marsden (1812) and Crawfurd (1852). Further, the Baba Malay aspectual system is compared to the aspectual system of Hokkien, as described in Bodman (1955).

2 Tense and the Two Time Axes

In Baba Malay (and in Malay), overall temporal settings are established lexically through the use of such phrases as *waktu jam pukul 7* 'at 7:00', *pada hari itu* 'on that day', or *kumudian* 'then'. Once a time axis is established, it remains until a new time axis is established.

Events may be reported on the past time axis or on the present time axis. Events reported on the past time axis are either reported in the sequence of occurrence, out of sequence, or as overlapping with other events. Events reported on the present time axis are reported as ongoing. Additionally, a prior event may be related to the present, just as a present event may be related to the future.

3 Chronological Events and Perfectivity

In narratives, the unmarked order for reporting events is in the order they occurred. In Baba Malay, if the chronological order is followed, no aspectual marking is needed to keep track of the event sequence. As an illustration, see example (1).

- (1) dan pintu itu pun terbuka, lalu rusa ini masuk
 and door that also TER-open then deer this enter
 ‘and the door opened, the deer entered,

dan pintu itu tertutup kembali.
 and door that TER-close return
 and the door closed again.’ (CDO:152-154)¹

In (1), the events are reported in chronological order; the first event is reported first, the second event is reported second, and so on. Additionally, each of the events is reported as “a single, unanalyzable whole, with beginning, middle, and end rolled into one” (Comrie 1976:3). In other words, these events are reported as if each one of them were over and done with before the next one occurred. That is, they are reported ‘perfectively’. This perfective interpretation of foregrounded events is the normal interpretation in discourse (Hopper and Thompson 1980:286).

As long as the narrative events are reported chronologically and perfectively, no aspectual marking is necessary. However, not all events are reported like that, and those that do not follow this convention require some aspectual marking. In Baba Malay, there are two kinds of aspectual marking — one that marks the event as ongoing and overlapping with some other events (the progressive aspect), and the other that marks the event as not being reported in its chronological order (the perfect).

4 The Progressive Aspect

In Baba Malay, an ongoing event that overlaps with other events is marked for the progressive aspect by *ada*. As an illustration, consider the passage in (2), which constitutes the continuation of the passage in (1).

- (2) Maka orang memburu itu ada perati-kan baik baik perbuatan
 then person MENG-hunt that ADA observe-KAN good good action
 ‘The hunter was carefully observing all the actions of

rusa ini smoa, serta lari-lah dia kepada raja-nya...
 deer this all along with run-LAH 3s to king-NYA
 the deer; then he ran to the king...’ (CDO:155-156)

In (2), the first event *peratikan* ‘observe’ is marked by *ada* as overlapping with the events reported in (1). The next event *lari* ‘run’, in turn, as a non-overlapping, perfective event, is not marked at all.

Figure 1 represents the events in passage (1-2). Note that the first three events are presented one after another, iconically -- that is, in the temporal order in which they occurred. The next event presented, the observing of the hunter, is not the next event to happen, but instead it overlaps with the three events just reported; thus, it is presented to the side. The fifth event, like the first three, is again reported in the order of occurrence and is unmarked.

Figure 1. In-sequence events and overlapping events on the past time axis

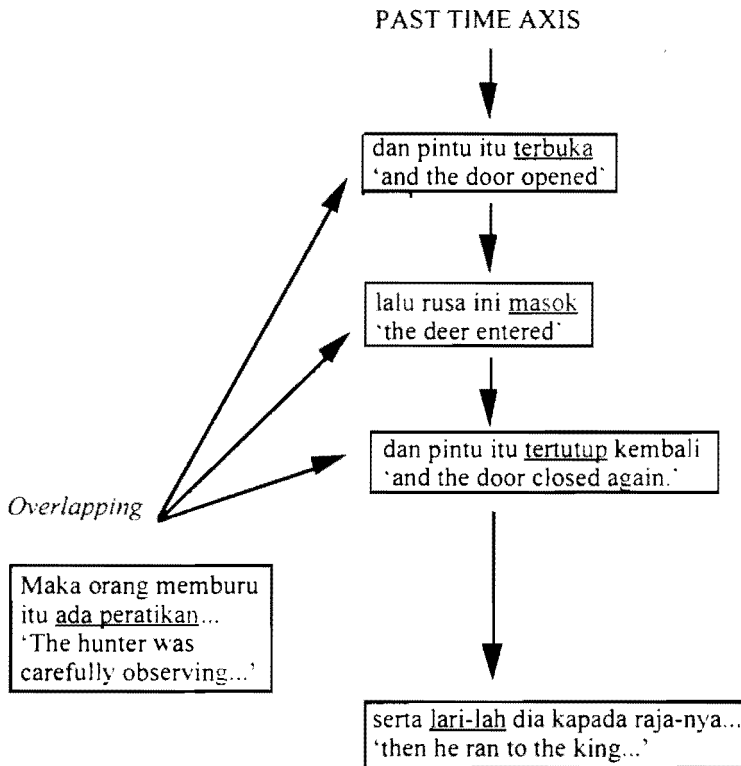

In Baba Malay, very much as in English (G. Thurgood 1990:296), events on the past time axis are reported as progressive when they overlap with other events. In my data, there are no examples of foregrounded events marked as progressive that do not overlap with another event.

However, with backgrounded events on the past time axis, *ada* forms may be used to report events that are both habitual and in progress. Comrie (1976:33) observes that "a given situation can be viewed both as habitual, and

as progressive, i.e., each individual occurrence of the situation is presented as being progressive, and the sum total of all these occurrences is presented as being habitual (the habitual of a progressive).” In the following example, the event is marked as progressive by *ada* and as habitual by an adverbial phrase.

- (3) dan sahari malam begini-lah macham semangat permesuri ini
and one-day evening in this way-LAH kind spirit of life queen this
'and every evening in this way the spirit of the queen

datang kepada anak-nya dan rusa-nya, tetapi semangat ini
come to child-NYA and deer-NYA but spirit of life this
came to the child and the deer, but the spirit

ta'perna bertutor spata pun kepada mak tiri-nya (si baboo tua itu).
not ever speak a word also to mother step-NYA SI domestic old that
never even spoke a word to the stepmother (the old nurse).

Maka si perempuan tua ini pun ada tengok
after that SI woman old this also ADA look
Then the old woman also saw

semangat itu sahari malam datang,
spirit of life that one-day evening come
the spirit come every evening.' (CDO:299-300)

In (3), only the verb of perception *tengok* is in the progressive form. The habitual character of the reported event is coded by the adverbial phrase *sahari malam* 'every evening'. Here is yet another example:

- (4) mak bapa dan saudaranya smoa pulang kerumahnya, tetapi
mother father and relative-NYA all return home to-house-NYA but
'the parents and relatives returned home to their houses, but

krap kali mak bapanya ada datang tengok anak menantunya.
often times mother father-NYA ADA come look child son-in-law-NYA
the parents often come to visit their son-in-law.' (PYC:419-420)

In example (4), as in example (3), it is again the cluster of two features that marks the events as progressive and habitual. It is the presence of *ada*, and it is the presence of the adverbial phrase *krap kali* reporting the frequency.

Examples (3-4) contrast with example (5).

- (5) rusa ini slalu makan rumput di tangan adek-nya.
deer this always eat grass at hand sibling-NYA
'The deer always ate grass from the hand of his sister.' (CDO:93)

In (5), the eating of the grass is reported as habitual and each individual occurrence of the event is presented as being perfective in contrast to (3-4), where each individual occurrence of the event is presented as in progress.

Of course, events may also be marked as progressive, not by *ada*, but by adverbial phrases such as *spanjang waktu* 'for a long time'.

- (6) kumdian ini tujuh dewa kecil mandilah, dan siser
 afterwards this seven deity small bathe-LAH and comb
 'afterwards these seven deities bathed, and combed

diaorang punya rambut, pakai diaorang punya pakaian yang chantek.
 3p have hair wear 3p have clothes that beautiful
 their hair, put on their beautiful clothes

dan kasot yang bagus, tetapi spanjang waktu diaorang ber-hias,
 and shoe that fine but one-long time they BER-decorate
 and fine shoes, but for the whole time they were beautifying themselves.

si Putri ini ada menangis sahja. kumdian diaorang ambil satu krosi
 SI princess this ADA MENG-cry only afterwards they take one chair
 the princess was just crying, then they took one chair

letkkan diluar khemah itu suruh si Putri dudok.
 put -KAN in-outside tent that order SI princess sit
 and put it outside the tent and ordered the princess to sit down.'
 (PYC:266-273)

In (6), *spanjang waktu* 'for a long time' marks the event of beautifying as overlapping with something else, just as *ada* marks the event of crying as overlapping with something else.

5 Out-of-sequence Events and the Perfect

In contrast to the foregrounded events, backgrounded events do not tell us what happened next in the story. More importantly in this context, backgrounded events are usually presented out of chronological order. Since they are frequently reported out of chronological order, they have to be overtly marked. In Baba Malay, out-of-sequence events are often marked by either *sudah* or *telah*.

- (7) dan raja kasihlah kapada dia itu kepok yang dia mahu, maka dia
 and king give -LAH to 3s that box that 3s want then 3s
 'and the king gave her the box that she wanted, then she took it,

ambillah, dan banyaklah suka hatinya. sebab dia sudah dapat itu kepok.
take-LAH and many-LAH joy liver-NYA reason 3s SUDAH get that box
and she was very happy. because she had got the box.’ (PYC:244-247)

In (7), the event of the king giving the box to his wife is reported at the beginning of this passage. At the end of the passage getting the box is again reported. The report about getting the box is clearly not the next event in the sequence; it has already happened earlier. This lack of chronology is marked by *sudah*, which marks the event as having occurred earlier than it is actually reported.

Like *sudah*, *telah* also marks the event as being out of sequence.

- (8) Pada suatu hari raja didalam negeri itu datang memburu, dan orang
on one day king at-inside country that come MENG-hunt and person
‘One day the king of that country came to hunt, and his

pemburu-nya smoa tiop-lah itu tandok. serta anjing anjing-nya pun
hunter -NYA all blow-LAH that horn while dog dog-NYA also
hunters all blew horns, together with his

menyalak-lah. lalu bergaong-lah dan riuh skali bunyi-nya didalam
MENG-bark-LAH then echo-LAH and noisy very sound-NYA at-inside
barking dogs, then the jungle echoed with very noisy sounds.

hutan itu. Maka rusa ini telah dengar swara swara yang begitu gaduh
jungle that then deer this TELAH hear voice voice that this way dispute
The deer had heard the voices which were arguing ...’ (CDO:98-102)

Long before it is reported in the narrative (in 8), the deer had heard the voices in the jungle.

Malay constitutes the obvious source of the Baba Malay system of aspectual markers. Baba Malay *telah* and *sudah* function in the same way in Malay. Crawford (1852:48) gives the following example of *telah* that he refers to as the auxiliary of the past time.

- (9) Maka didângâr Chandra biduwan. itupun chuchor
then di-hear Chandra singer that-PUN flow
‘It was heard by Chandra, the public singer, and thereupon

ayâr-mataña. târkânâng suwamiña yâng tâlah mati.
water-eye-NYA ter-know husband-NYA that TELAH dead
she wept, remembering her husband who was dead.’ (Crawford 1852:49)

Although Crawford (1852) does not comment, his examples make it clear that he is aware of the aspectual function of *telah*. Within the framework adopted here, it can be said that in (9) the clause with *telah* relates the earlier event of dying to the event of crying, which is on the main storyline.

For the Baba speakers, the Malay perfect was a new aspectual distinction. Hokkien, the language they shifted from, has a different aspectual distinction. It marks the perfective. The marker of the perfective is *liáu* (Bodman, 1955:203).

(10) ciáq-liáu boū hòu ciáq

eat-finish NEG good eat

'This food wasn't good to eat.'

(Literally: 'Having eaten this food (up), it didn't taste good.')

(11) guá cā-zit khuà-liáu hit-pún chéq

1s yesterday read finish that CL book

'I finished reading that book yesterday.' (Bodman, 1955:202-203)

When shifting to Malay, the Baba speakers learned not only a new aspectual distinction, but also a new word order. In Hokkien, the aspectual marker follows the verb. In Baba Malay, however, as in Malay, the aspectual marker always precedes the verb.

5.1 Aspectual markers related to a time axis

In Baba Malay, *telah* and *sudah* are not the only aspectual markers relating events to a time axis. Some of the other markers with aspectual meaning are *bahru*, and the aspectual combination *telah ada*. These markers occur in passage (13). The past time reference was established earlier (passage 12).

(12) anam bulan dahulu, bila angkau datang di Malaka,

six month past when 2s come in Melaka

'six months ago, when you came to Melaka.

kenapa angkau tada pergi jumpa saya?

why 2s not be go visit 1s

why didn't you visit me?' (SPB:5-6)

(13) Bila angkau sudah balek ke Singapura, bahru sahya

when 2s SUDAH return KE Singapore just 1s

'When you went back to Singapore, only then I learned

dapat tahu yang angkau telah ada datang di Malaka.

get know YANG 2s TELAH ADA come to Melaka

that you had been in Melaka.' (SPB:8-9)

In example (13), the three events reported out of sequence are *balek* 'return', *dapat tahu* 'learn' and *datang* 'come'. Although these events are out of sequence, information about their relationship to the past time axis and thus to their chronological order is indicated by three different aspectual markers — *telah ada*, *sudah*, and *bahru*. *Telah ada* marks *datang* 'come' as past perfect and, in this sequence, the first chronological event; *sudah* marks *balek* 'return' as perfect, and, in this sequence, the second event; and, *bahru*, best translated into English as 'just a short while earlier', marks *dapat tahu* 'learn' as a more recent past event. On the past time axis, the three degrees of relative prior time reference may be represented as in Table 1.

Table 1. Three degrees of relative prior time reference

<i>telah ada</i> past perfect (pluperfect)	<i>sudah, telah</i> perfect	<i>bahru</i> perfect 'lit. newly; recently'
<u>distant</u>	<u>unmarked</u>	<u>immediate</u>

Table 1 shows the three degrees of perfect meaning -- that is, of relative prior time reference.

5.2 The clarification of sequencing: *apabila* clauses

Besides marking events as out of sequence, aspectual markers may also be used to mark events as sequential when otherwise this would not be clear. This function of aspectual markers may be observed in *apabila* clauses. The reason for using *telah* or *sudah* in *apabila* clauses is that the conjunction *apabila* 'when' by itself does not signal whether two events overlapped or occurred sequentially.

- (14) Apabila tunangnya datang bukakan pintu, dia berkata.
 when fiancé-NYA come open-KAN door 3s say
 'when her fiancé came and opened the door, she said, ...' (CDHMT:43-44)

In (14), it is not clear whether the two events of the fiancé's opening the door and the fiancée's speaking (*dia berkata*) are overlapping or sequential. However, this ambiguity is resolved if one of the events is overtly marked as having occurred before the other event.

- (15) Apabila mak tirinya sudah pergi, anak tirinya ini bangun,
 when mother step-NYA SUDAH go child step-NYA this get up
 'When the stepmother had left, her stepchild got up,' (CDHMT:39-40)

- (16) apabila raja ini telah menengar perkata'an baboo tua itu, dia berkata. ...
 when king this TELAH MENG-hear word servant old that 3s say
 'when the king had heard the words of the old servant, he said, ...'
 (CDO:310-311)

In examples (15-16), *sudah* and *telah* are used, not because something is reported out of sequence, but because otherwise it is unclear whether the events are overlapping or sequential. Thus, *sudah* and *telah* mark the sequentiality of the reported events.

6 The Present Time Axis

Although narratives are usually told on the past time axis, other kinds of discourse may use the present time axis. The present time axis usually characterizes the time of the speech situation. In Baba Malay, the present time axis event, if in progress, is reported with *ada*.

- (17) apa-kah rumah rumah sakit (hospital) ada buat?
 what-Q house house ill hospital ADA do
 'What are hospitals doing about it?' (OM:13)

In Lim's (1887) colloquial Baba Malay, *ada* also marks the progressive aspect. For example:

- (18) dia ada smo-nyet di Singapura jugah.
 3s ADA hide in Singapore still
 'he is hiding himself in Singapore'

 dia blom lari lagi peggi laen neggri.
 3s not yet run still go other country
 he has not yet run to any other country.' (Lim 1887:121)

In contrast to Baba Malay where only *ada* marks an event in progress, nineteenth century Malay has more aspectual markers reporting events in progress. Crawford's (1852:51) list includes the following: *sāraya*, *sādāng-lagi*, *sādāng*, *sārta* and *sālāng*. However, he does not mention *ada*. In contrast, Marsden (1812) records *ada* as a progressive marker when he calls the *ada* forms present participles. Marsden (1812:77-79) gives the following forms as examples:

- (19) ada tidur
 ADA sleep
 'is sleeping'

- (20) *ada samun*
 ADA rob
 'is robbing'

He also gives the following clause as an example:

- (21) *di'orang ada berjalan*
 3p ADA walk
 'they are walking' (Marsden 1812:68)

Clearly, nineteenth century Malay *ada* functions as a progressive marker, but for some reason it is not recorded by Crawfurd (1852). More studies of early modern Malay are needed before it is possible to reconcile this discrepancy.

In Hokkien, the equivalent construction is formed with *têq*. Bodman (1955:118) says that *têq* usually occurs before the verb, but it "appears after certain verbs indicating a continuing or unchanging state". As an illustration, compare examples (22) and (23).

- (22) *i têq oûq kóng lêng-bún.*
 3s *têq* learn speak English
 'He's learning to speak English.'

- (23) *gún pè-bù bou tî teq*
 1s parents NEG live *teq*
 'My parents are not living.'

In (22) *têq* occurs in front of the verb; in (23) it occurs after the verb.

6.1 Present perfect

A particular event may be reported as having occurred in the past but as being relevant to the present time axis. A past event, if relevant to the present time axis, is reported with either *sudah* or *telah*.

- (24) *Siapa yang sudah chabot jarom jarom itu deri sahya punya badan?*
 who that SUDAH pluck needle needle that from 1s have body
 'Who has plucked the needles from my body?' (PYC:107)

Question (24) is uttered by the king, who realizes that he has woken up because somebody plucked the needles from his body. He says later:

- (25) *Sahya sudah tidor dua blas tahun, skarang sahya bangun*
 1s SUDAH sleep two teen year now 1s get up
 'I have slept twelve years, now I get up' (PYC:188-189)

In examples (24-25), *sudah* indicates what Comrie (1976:60) ascribes to perfect — namely, “the continuing present relevance of a past situation.”

In Baba Malay, not only *sudah*, but also *telah* relates the past event to the present time axis.

(26) Maka suatu surat khabar di Singapura telah dapat kenyata'an adapun
and one letter news in Singapore TELAH get declaration ADA-EMPH
'A newspaper in Singapore has received a notice that

banyak orang orang miskin datang ka Singapura deri
many people people poor come KE Singapore from
a lot of poor people come to Singapore from

lain lain tempat, dan bawa dengan dia-orang penyakit
other other place and bring with they disease
other places. and bring with them disease ...' (OM:11)

In (26), the event of having received the information about a lot of people coming to Singapore with different kinds of diseases is related to the present time axis.

As a marker of the perfect aspect, *sudah* may also be used to code an event that started in the past and continues until the present.

(27) Ini surat gade ini hari sudah chukop tempu.
this letter pawn this day SUDAH full time for payment
'This mortgage deed is due today,' (Lim 1887:122)

The event reported in (27) is marked by *sudah* as past, but relevant to the present situation.

6.2 Events ahead of the present

From the present time axis, it is also possible to refer to a future time.

(28) dan skarang malam bila dia tidor sahya nanti datang penggal
and now evening when 3s sleep 1s later come break off
'and this evening when she is asleep I will come and break off

kepalanya tetapi jaga baik baik,
head-NYA but take care of good good
her head taking care of her very well,' (CDHMT:17-18)

In (28), the event reported by the temporal clause *bila dia tidor* 'when she is asleep' is not specified for futurity, but the following event is specified as the

future event by *nanti*. In Baba Malay, as in Malay, *nanti* marks the event for a later time, but within a particular day (Mintz 1994:308).

To conclude, from the present time axis, Baba Malay aspectual markers (1) relate a past event to the present time (with *sudah, telah*), (2) mark an event as in progress (with *ada*), (3) relate an event that has just happened with *bahru*, and, (4) relate an event that is about to happen (with *nanti*) -- that is, one that will happen at a point in time just ahead of the present. These aspectual markers are represented in Figure 2.

Figure 2. Aspectual markers on the present time axis

PRESENT TIME AXIS			
<i>sudah, telah</i> perfect	<i>bahru</i> perfect (recent)	<i>ada</i> progressive	<i>nanti</i> near future (recent)
a prior event related to the present	event just completed	ongoing event	event just ahead

7 Conclusions

The Baba Malay aspectual system has been analyzed as a discourse related phenomenon, one in which aspectual markers correlate with the narrative discourse structure. In this analysis, the function of the aspectual system has also been correlated with two time axes — the past time axis and the present time axis. The aspectual functions of such markers as *sudah, telah*, and *ada* interact with foregrounding, backgrounding, and the time axis. In a narrative with a past time axis, *sudah* and *telah* mark events as occurring out of sequence or, more rarely, as sequential rather than overlapping, while *ada* marks events as overlapping with other events. In a speech situation on the present time axis, *ada* marks events as ongoing and *sudah* and *telah* mark past events as relevant to the present. Besides *sudah, telah*, and *ada*, Baba Malay has other aspectual markers, such as *nanti* or *bahru*, and the aspectual combination *telah ada*.

Malay constitutes the obvious source of the Baba Malay aspectual system. However, in the Baba Malay system several modifications have been made. First, *ada* is apparently far more common in Baba Malay than it was in contemporary Malay. Second, Malay has other aspectual markers that Baba Malay lacks. Third, the combination *telah ada* occurs in Baba Malay, but is not reported in the grammars by Marsden (1812) and Crawford (1852).

Although Malay constitutes the primary source of the Baba Malay aspectual

system, it is possible that at the end of the nineteenth century the English known by many Baba Malay speakers reinforced the Malay system as learned by the Babas. The English aspectual system has the same aspectual categories: the progressive and the perfect.

The aspectual system of Hokkien, the language that the Babas shifted from, might have reinforced the Baba Malay progressive aspect, but not the perfect. From the perfective used in Hokkien, the Baba speakers shifted to a new aspectual distinction — the perfect.

Notes

* I am grateful to Graham Thurgood and Ricky Jacobs for their feedback.

¹ The following abbreviations are used in English glosses:

CL	classifier
EMPH	emphatic particle
NEG	negative participle
Q	question marker
1p	first person, plural
2p	second person, plural
3p	third person, plural
1s	first person, singular
3s	third person, singular

References

- Binnick, Robert I. 1991. *Time and the verb. A guide to tense and aspect*. New York, Oxford: Oxford University Press.
- Bodman, Nicholas C. 1955. *Spoken Amoy Hokkien*. Kuala Lumpur: Charles Grenier & Son Ltd.
- Brinton, Laurel J. 1988. *The development of English aspectual systems*. Cambridge: University Press
- Comrie, Bernard. 1976. *Aspect*. Cambridge: University Press.
- Crawford, John. 1852. *Grammar and dictionary of the Malay language with a preliminary dissertation*. London: Smith, Elder, and Co., 65, Cornhill.
- Hopper, Paul J. 1979. "Aspect and foregrounding in discourse. Syntax and semantics", *Discourse and syntax*, 12, 213–241. New York: Academic Press.
- _____ and Sandra A. Thompson. 1980. "Transitivity in grammar and discourse", *Language* 56.2: 251–299.
- Labov, William and Joshua Waletzky. 1967. "Narrative analysis: oral versions of personal experience", *Essays on the verbal and visual arts. Proceedings of the 1966 Annual Spring Meeting of the American Ethnological Society*: 12–44. Seattle: University of Washington Press.

- Lim. Hiong Seng. 1887. *A manual of the Malay colloquial such as is spoken by all nationalities in the Colonies of the Straits Settlements, and designed for domestic and business purposes*. Singapore: Koh Yew Hean Press.
- Marsden. William. 1812. *A grammar of the Malayan language with an introduction and praxis*. London: Cox and Baylis.
- Mintz. Malcolm W. 1994. *A student grammar of Malay and Indonesian*. Singapore: EPB Publishers Pte Ltd.
- Thomason. Sarah Grey. and Terrence Kaufman. 1988. *Language contact, creolization, and genetic linguistics*. Berkeley: University of California Press.
- Thurgood. Graham. 1990. "English tense and aspect in narrative: perfectivity, imperfectivity, and the two time axes", *Proceedings of the Western Conference on linguistics*. 3:290-302.

Elzbieta Thurgood
 Department of Linguistics,
 California State University, Fresno
 Fresno, CA 93740-0092
 elzbieta@csufresno.edu

Causatives in Northern Sámi and the Role of Dative Case

Mikael Vinka

McGill University

1. Introduction

This paper discusses some aspects of causative constructions in Northern Sámi, a Finno-Ugric language spoken in Northern Scandinavia. When we carefully examine causatives, we are able to distinguish two subtly different dialects, that I will call A (NSA) and B (NSB). Dialect A has been described in Nickel (1994) and my own field-work, and dialect B has been described in Julien (1995) and (1996). (1a) shows that a causative is well formed in both dialects if the Dative Causee precedes the Accusative Object. However, if the Accusative Object occurs to the left of the Causee, as in (1b), then we find that this results in illformedness in dialect B. (1b) is, however, perfectly fine in dialect A. Moreover, (1c) shows that the Theme may be promoted to Subject in a passivized causative in dialect A, but not in dialect B.

- (1) A B
a ✓ ✓ Elle tʃáli-h-ii Bierai reivve. (Julien 1996:161)
Elle.NOM write-CAUSE-PST.3SS Biera.DAT letter.ACC
'Elle made Biera write a letter.'
b ✓ * Elle tʃáli-h-ii reivve Bierai.¹
Elle.NOM write-CAUSE-PST.3SS letter.ACC Biera.DAT
'Elle made Biera write a letter.'
c ✓ * Reive tʃáli-h-uvvui Bierai. (M.Julien, p.c)
letter.NOM read-CAUSE-PASS.PST.3SS Biera.DAT
'A letter was caused to be written by Biera.'

A further word order difference between the two dialects is found in the possibility for Dative Subjects in passivized causatives. As (2) illustrates, dialect A allows the Dative Causee to be promoted to Subject in a passive. But also as seen in (2), this is impossible in dialect B

- (2) A B
 √ * Bierai tjáli-h-uvvui reive. (M.Julien, p.c)
 Biera DAT write-CAUSE-PASS.PRS.3S letter NOM
 'Biera was made to write a letter'

I propose that Northern Sámi A and Northern Sámi B differ with respect to the setting of one specific micro-parameter, that will I call the Dative Parameter, stated in (3).

- (3) THE DATIVE PARAMETER
 If a language has Dative Case marking, then the Dative is realized either
 (i) as a particular nominal (D) feature, or
 (ii) as a syntactically visible Case feature.

Datives that are instantiated in accordance with (3i) will be shown to be transparent to Case-motivated applications of Attract, since they do not carry a Case feature. Also, they may serve as Subjects. Hence Dialect A represents (3.i). However, Datives instantiated in accordance with (3.ii), constitute barriers to Case-driven applications of Attract, and they can not serve as Subjects. Thus Dialect B represents (3.ii).²

The paper is organized as follows. Section 2 discusses Dative Subjects. Section 3 is concerned with Object Scrambling. Section 4 deals with Passivization and section 5 provides some concluding remarks.

2. Dative subjects

As is well known, languages with overt marking of Dative Case do not behave uniformly with respect to whether Datives are licit as Subjects or not. For instance, Icelandic freely allows a Dative DP to serve as a Subject, in contrast to German (cf. Zaenen, Maling & Thrainsson 1990 and Freidin & Sprouse 1991). As we saw in (2) above, Northern Sámi A and B appear to differ in a similar fashion

In order to determine the Grammatical Function of the NSA Dative DP in (2), we refer to Zaenen, Maling & Thrainsson (1990), who presented a number of syntactic tests that single out Subjects from other constituents in Icelandic. For example, only Subjects can undergo Subject-raising. If we embed a Dative-initial infinitival clause under a raising verb, we find that the Dative DP in dialect A can move into the matrix Subject position, as shown in (4). This provides evidence that the Northern Sámi A Dative DP in (2) is a Subject rather than some preposed constituent.³

- (4) Bierai orru tjáli-h-uvvo-me reive.
 Biera.DAT seem.PRS.3S write-CAUSE-PASS-ACTLOC letter.NOM
 'Biera seems to be made to write a letter.'

How does the Dative Parameter account for the different possibilities for Dative Subjects in Northern Sámi A and B? Let us begin with dialect A. According to our hypothesis, Dative Case in this dialect is simply a D feature. In other words, the feature composition of a Northern Sámi A Dative DP closely resembles the English expletive *there* (cf. Chomsky 1995:287). Chomsky claims that *there* has a D feature, but crucially lacks a Case feature, and therefore it can only check D features. If we consider a sentence with a Dative Subject like (2) or (4), it seems reasonable to assume that the Dative Causee satisfies the EPP, which I assume involves the checking of a strong D feature of T. Hence the EPP is divorced from Case. This is illustrated in (5). Since the Dative DP1 lacks a Case feature, it fails to check the Nominative feature of T. Following Chomsky (1995) and Collins (1997), the Nominative feature of T is weak and therefore it can attract the Nominative DP2 covertly.

(5)

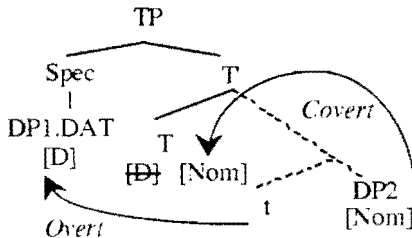

In Northern Sámi B, on the other hand, Dative is a syntactically realized Case feature. Consider the representation in (6) for example (2). In (6) the Dative NP has moved into the Spec of TP as a result of the EPP. Notice now, that the Case features of DP1 and T are in a checking configuration. Chomsky (1995: 308-9) and Collins' (1996:21), claim that the checking of a feature cannot be delayed if a checking configuration has been created. With respect to (6), it is important to pay attention to the fact that the *values* of the two Case features are different, namely Nominative versus Dative. This, I claim, constitutes a feature-mismatch, and in accordance with Chomsky (1995:309), a derivation is canceled if a feature-mismatch arises, as stated in (7). These assumptions put together implies that the Nominative feature of T must be checked against the accessible Case feature of the DP in the specifier of T. But checking cannot obtain since the values of the Case features fail to match. Hence the derivation is canceled.

(6)

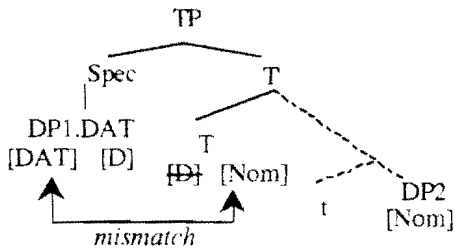

(7) Mismatch of features cancels the derivation. Chomsky (1995:309)

In this section we have shown that Northern Sámi A and B differ with respect to their ability to license Dative Subjects. We have argued that this difference reflects a parametric difference.

3. Object scrambling and the lack of it

In this section I will discuss Object scrambling. Recall from example (1b) that Object scrambling is allowed in dialect A, but not in dialect B. It is important for our understanding of both dialects, to determine the nature of Object scrambling in dialect A.

In order to tease out the properties of Object scrambling in Dialect A, we will consider A-binding possibilities. In the sentences in (8), the Causee precedes the Theme, and the Causee serves as the A-binder of the anaphor contained in the Theme. Notice that anaphoric elements in Northern Sámi agree with their antecedents. Thus, in (8a) the Causee is dual and therefore the anaphor surfaces with dual morphology. In (8b) the Causee is a plural pronoun and the anaphor displays plural morphology.

- (8) a Mun doala-h-an [Márehii ja Birehii]_i [*gudesge guoibmá-me_i* beatnagiid].
 I.NOM hold-CAUSE-PRS.1SS M.DAT&B.DAT each other.GEN-2DPOSS dogs.ACC
 'I make Máret and Biret hold each other's dogs.'
- b Áhtti_i daga-h-ii daidda_i [*gudesge guoibmá-me_i* niibiid].
 father.NOM repair-CAUSE-PST.3SS they.DAT each other.GEN-3PPOSS knives.ACC
 'Father made them repair each other's knives.'

If Object scrambling is A'-movement, then we expect to find reconstruction effects in scrambled sentences. However, as shown in (9), no such effect found. In (9) the Theme has scrambled across the Causee, with the result that the binding relation that holds in (8) is destroyed.

- (9) a *Mun doala-h-a *gudesge guoibmä-me*; beatnagiid]; Märehi ja Birehi]; t_j.
 I.NOM hold-CAUSE-PRS.3SS each other GEN-3DPOSS dog.PL.ACC M.DAT & B.DAT
 'I make Märet and Biret hold each other's dogs.'
 b *Aht]fi daga-h-ii [*gunesge guoibmämet*]; niibiid]; daidda]; t_j.
 father.NOM repair-CAUSE-PST.3SS each other.3DPOSS knives.ACC they.DAT
 'Father made the them repair each other's knives.'

We now turn to (10). Here we can see that the scrambled Object may become the antecedent of an anaphor contained within the Causee. This, then, indicates that the Theme has undergone A-movement and that it c-commands the anaphor.

- (10) a Mun doala-h-a beatnagiid]; [*gudesge guoibmä-me*]; eaiggádii] t_j .
 I.NOM hold-CAUSE-PRS.1SS dogs.ACC each other.Gen-3pPoss owner.DAT
 'I make the dogs be held by each other's owner.'
 b Mun t]ajeha-htt-en máná]; [*iezas*]; vielljai] t_j.
 I.NOM show-CAUSE.PST.1SS child.ACC self GEN.3SPOSS brother.DAT
 'I made the child be shown by its own brother.'

To complete the picture, in (11) the scrambling of (10) is undone, and the result is that the Theme cannot bind the Causee. The contrast between (10) and (11) clearly shows that Object scrambling affects the possibilities for A-binding, and therefore should count as A-movement:

- (11) a *Mun doala-h-a [*gudesge guoibmä-me*]; eaiggádii] beatnagiid];
 I.NOM hold-CAUSE-PRS.1SS each other.Gen-3DPOSS owner.DAT dogs.ACC
 'I make the puppy to be held by its owner.'
 b *Mun tajeha-htt-en [*iezas*]; vielljai] máná];
 I.NOM show-CAUSE.PST.1SS self.Gen.3SPOSS brother.DAT child.ACC
 'I made its own brother show the child.'

Before we turn to the analysis, I should spell out a few assumptions. To begin with, I follow Baker (1988) and analyze the causative morpheme as a verb. Moreover, based on insights by Li (1990) and Baker (1995), I assume that the causative verb takes a bare vP as its complement. In the structure in (12) these are labeled vP1 and vP2 respectively.⁴

(12) *Basic Structure of Causatives*

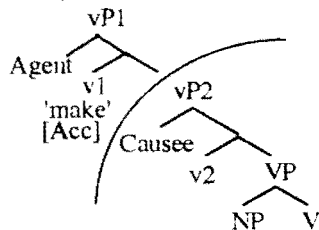

Now, a quick word concerning so-called Case-Preservation effects. Following Baker (1995), Larson (1988), to mention a few, I assume that in order for a verb to check (or assign) Accusative Case, it must receive the right kind of functional support. As stated in (13), this means that the verb must be selected by say Infl. So, although it is a necessary requirement that a Case feature [Acc] be licensed by *v*, it is not a sufficient condition. Hence only *v1* in (12) is, descriptively speaking, a Case-assigner.

(13) LICENSING PRINCIPLE FOR STRUCTURAL CASE

In order to license structural Case, *v* must receive functional support from Infl.
(cf. Baker 1995, Larson 1988, Abney 1987 etc.)

Let us now turn to the structures in (14). I assume that a non-scrambled causative in Northern Sámi has the schematic representation (14a). Now, following Chomsky (1995), I assume that the Case features of verbs may be overtly checked in a multiple spec configuration.⁵ The structure (14b) illustrates a causative where Object scrambling has applied. Since we have established, that scrambling is A-movement, and since Case is a potential source for A-movement, I assume that the base-object has moved into a Specifier of *v1*, overtly checking Accusative Case. These representations are fully compatible with binding facts presented above.

(14) a

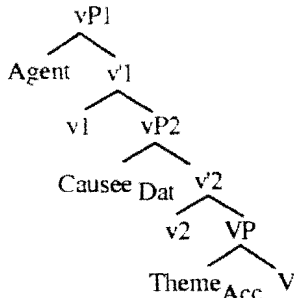

b

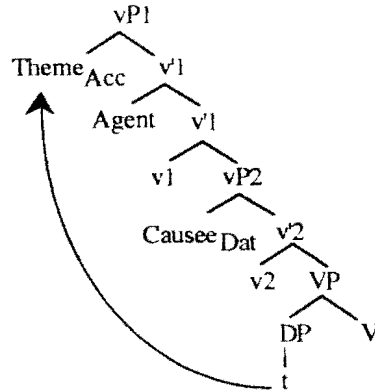

But now, why is (14b) OK in Northern Sámi A, but not in Northern Sámi B? According to the hypothesis we started out with, Dative-Case in dialect A is not a Case, but rather a D feature. As for Dialect B, we claimed that Dative indeed is a full-fledged Case feature. Let us now consider the consequences of this hypothesis, by turning to the definitions of Attract and Closeness, given in (15) and (16).

- (15) ATTRACTF (Chomsky 1995:297)
K attracts F if F is the closest feature that can enter into a checking relation with a sublabel of K.
- (16) CLOSENESS (Chomsky 1995: 356)
If b c-commands a and t is the target of raising, then b is *closer to K* than a unless b is in the same minimal domain as (a) t or (b) a.

Chomsky (1995:297) claims that a sublabel of a head attracts a feature of a DP in order to check the features of the head. Moreover, let us assume that the feature of the head attracts *a feature of the same kind* associated with the DP. That is, if the attracting feature is a Case feature, then it attracts another Case feature. Consider the scenario where the Case feature of v_1 in (14) attracts another Case feature. If, by hypothesis, the Causee in dialect A lacks a Case feature, then the Case feature of the Theme is the closest candidate to be attracted, by the definition of Closeness in (16). Consequently, the Theme can raise across the Causee in dialect A, as further illustrated in (17):

- (17)
- $$\begin{array}{c} [_{VP1} \text{ V-Cause } [_{VP2} \text{ DP}_{\text{Dat}} [_{VP} \text{ DP }]]] \\ | \qquad \qquad \qquad | \qquad \qquad \qquad | \\ \text{[ACC]} \qquad \qquad \qquad \longleftarrow \qquad \qquad \qquad \text{[ACC]} \end{array}$$

However, if Dative is realized as a syntactic Case feature, as in Northern Sámi B, then the locality condition imposed on Attract, prevents the Theme from being attracted. This is so for the simple reason that the Causee c-commands the Theme, and the two are not in the same minimal domain. In other words, the Causee constitutes a barrier for movement of the Theme, as illustrated in (18):

- (18)
- $$\begin{array}{c} * [_{VP1} \text{ V-Cause } [_{VP2} \text{ Causee } [_{VP} \text{ Theme }]]] \\ | \qquad \qquad \qquad | \qquad \qquad \qquad | \\ \text{[ACC]} \qquad \qquad \qquad \text{[DAT]} \qquad \qquad \qquad \text{[ACC]} \end{array}$$
-

Now, of course, the question arises how the Accusative Case of the Theme in dialect B could be checked at all? If overt checking is blocked in (18), then it should also be blocked covertly. In order to get around this problem, I refer to a suggestion by Fukui & Takano (1997), who argue that certain types of morphological Cases are visible to the application of Spell-Out, and stripped off by Spell-Out, which gives us the assumption (19):

- (19) Case morphology makes a Dative Case feature visible to Spell-Out.
(Based on Fukui and Takano 1997:32).

(19) renders pre-spell-out checking of Accusative impossible in dialect B, just as shown in (18). However, assume now that Spell-Out strips off the Dative Case feature from the Causee, as shown in (20a). This has the effect of enabling checking of Accusative Case at LF in dialect B, as shown in (20b):

(20a) "Checking" by Spell-Out

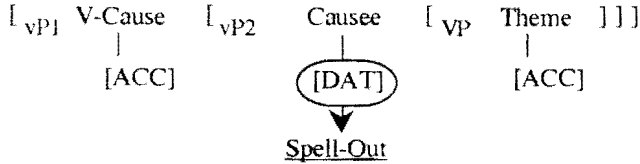

b LF checking of Theme

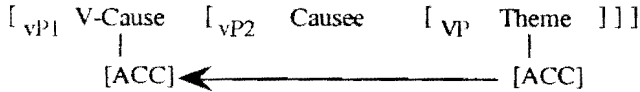

In this section I have shown that Object scrambling in Northern Sámi A is an instance of A-movement. This in turn made us draw the conclusion that somehow this A-movement is blocked in Dialect B. We have attributed this to the Dative Parameter, which enables us to find a non-coincidental connection between Object scrambling and Dative Subjects.

4. Passives

The example in (21) illustrate the same point as example (1c), namely the fact that causatives based on transitive base verbs can be passivized in dialect A, but not in dialect B.

- (21) A B
 √ * Láibi bora-h-uvvo mánnái. (Julien 1995:82)
 bread.NOM eat-CAUSE-PASS.PRS.3SS child.DAT
 'The bread is caused to be eaten by the child.'

I will claim that passivization of causatives in dialect B is impossible, since this would involve A-movement of the Theme across the Causee. I.e. (21) is bad in dialect B for the same reason that Object scrambling is bad in that dialect. We now predict that if no Dative DP is found intervening between the matrix Subject position and the Accusative Object, then passivization should be fine also in dialect B. Consider (22a). Here the base verb is intransitive, and as is common in many languages, the single argument of the base verb shows up with Accusative Case irrespective of its thematic status. Turning to the passive in (22b), we find that it is well formed not only in dialect A, but also in B:

- (22) A B
 a √ √ Beana tʃieru-ha máná. (Julien 1996:162)
 dog.NOM cry-CAUSE.PRS.3SS child.ACC
 'Joavvna causes the child to cry.'
 b √ √ Mána tʃieru-h-uvvui. (Julien 1996:162)
 child.NOM cry-CAUSE-PASS.PST.3SS
 'The child was caused to cry.'

However, the most striking piece of evidence that it is the presence the Dative DP that causes the ungrammaticality of (21) in dialect B, reveals itself when we consider the possibility for Causeless causatives. The possibility of suppressing the Causee is a common phenomenon, found in a wide range of unrelated languages, such as Germanic and Bantu. Also Northern Sámi has this option. If the Causee is suppressed, it is nevertheless implicit, and is interpreted as *someone*. Thus in (23), someone other than the causative Agent eats the bread:

- (23) A B
 √ √ Áhtʃji bora-h-a láibbi. (Julien 1995:82)
 father.NOM eat-CAUSE.PRS.3SS bread.ACC
 'Father makes *someone* eat the bread.'

Let us stipulate the (partial) representation (24) for (23). As (24) shows, no Agent is generated in vP2. However, the head v2 is still syntactically present, ensuring that the base verb is transitive, and therefore also retains its agentivity. A similar proposal, however based on somewhat different theoretical assumptions, has been made in Taraldsen (1991).

(24)

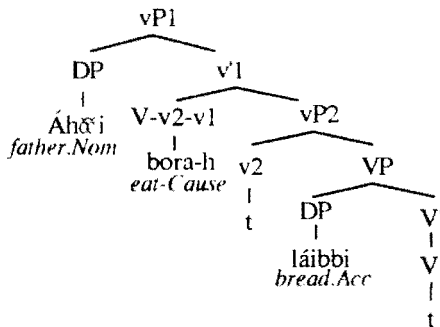

What is interesting about Causeless causatives in Northern Sámi B is the fact that they may be passivized, unlike cases where the Causee is present. Consider the passive in example (25). As we can see it is well formed in both dialects.

- (25) A B
 √ √ Láibi bora-h-uvvui. (Julien 1995:203)
 bread.NOM eat-CAUSE-PASS.PST.3SS
 'Bread was made to be eaten by someone.'

The well formedness of example (25) in dialect B provides good evidence that it is the presence of a Dative Causee that blocks passivization in the dialect B example (21).

Let us now consider an additional quirk of passives in Northern Sámi A. In example (26), we have an active infinitival causative clause embedded under an ECM verb. As (26a) shows, the Subject of the embedded clause can appear with Accusative Case. And as (26b) shows, the sentence is bad if the embedded Subject surfaces with Nominative Case; hence Accusative marking is mandatory. This is hardly surprising, since the standard assumption is that the embedded infinitival clause lacks a source for Nominative Case. However, turning to (27), things become a little bit more interesting. In (27), the infinitival complement clause is passivized. In (27a) the Theme argument has been promoted to Subject, but notice that it is not possible for the Subject to surface with Accusative Case. Rather, as (27b) shows, the Theme must surface with Nominative Case, even though the embedded clause is infinitival:

- (26)a Máhtte vurddi [mu loga-hit dutnje girjji].
 Máhtte.NOM expect.3SS.PST I.ACC read-CAUSE.INF you.DAT book.ACC
 'Máhtte expect me to make you read the book.'
 b *Máhtte vurddi [mun loga-hit dutnje girjji].
 Máhtte.NOM expect.3SS.PST I.NOM read-CAUSE.INF you.DAT book.ACC
 'Máhtte expect me to make you read the book'
- (27)a *Máhtte vurddi [girjji loga-h-uvvot dutnje].
 Máhtte.NOM expect.3SS.PST book.ACC read-CAUSE-PASS.INF you.DAT
 'Máhtte expect the book to be made to be read by you'
 b Máhtte vurddi [girji loga-h-uvvot dutnje].
 Máhtte.NOM expect.3SS.PST book.NOM read-CAUSE-PASS.INF you.DAT
 'Máhtte expect the book to be made to be read by you'

These examples clearly show that a passivized sentence in Sámi has some source for Nominative Case that is not found in active clauses. I propose that a Nominative Case feature is licensed by the passive morpheme, and that it may be realized in the passivized verb or in Infl, as stated in (28). I also make the additional assumption that if Nominative occurs in Infl, then it is weak, (28.i) but if it occurs in the passive V, then it is strong, (28.ii).⁶ (28.i) is thus relevant for the previous discussion in Section 2.

- (28) Nominative Case can occur in Infl or in V-Passive.
 (i) If the feature [Nom] is in Infl, then it is weak.
 (ii) If the feature [Nom] is in V-Pass, then it is strong.

Consider now the derivations in (29), where the Nominative feature occurs in the passivized *v*. By assumption (28.ii), the Nominative feature is strong, and hence attracts overtly. In Northern Sámi A, the Nominative Theme can be attracted by the Nominative feature of the passivized verb, as shown in (29a), since the Causee lacks a Dative Case feature. However, turning to dialect B, where the Dative Causee is taken to carry a Case feature, we find that the Theme no longer counts as closest for the purposes of Attract, and therefore it can not raise. However, since the Nominative feature of the verb is strong, it must be checked before Spell-Out, but it can't. Therefore the derivation crashes, or is canceled.

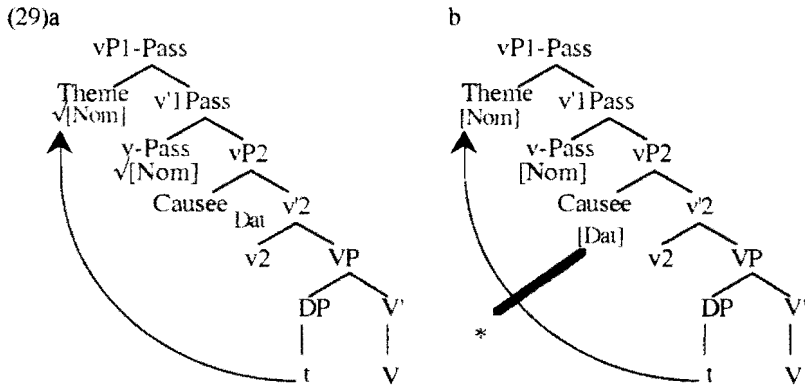

5. Conclusion

In this paper I have argued that the two dialects of Northern Sámi differ with respect to how Dative Case is realized. I have proposed that Dative Case can be realized either as a particular kind of D feature, or as a syntactic Case feature. I have argued that the Dative Parameter has consequences not only for the possibility for Dative Subjects, but also for what we may loosely refer to as long-distance A-movement.

While I have mentioned parallels with German and Icelandic, it is obvious that the proposal must stand up to testing against a wider range of languages. However, the major descriptive purpose of this study has been to undertake an investigation of a fairly unstudied language.

Acknowledgements

I wish to thank the audience at WECOL 1998 for valuable comments, questions and discussion. This research was supported by FCAR grant (97ER0578) 'On Syntactic

Categories' to Mark Baker, Jonathan Bobaljik, Claire Lefebvre and Lisa Travis, to which I am grateful. I am especially indebted to Mark Baker, who has followed this research from the very beginning. I also thank Jonathan Bobaljik, Nigel Duffield, Hiro Hosoi, marit Julien, Mikael Svonni and Lisa Travis. Remaining errors, inadequacies, misinterpretations of data etc. all belong to me. Unless otherwise indicated, the examples in this paper are taken from my own field notes.

Footnotes

¹Thanks to Mark Baker (p.c) (with reference to Julien (p.c.)) for making me aware of this sentence. This sentence is well formed under an irrelevant reading where the dative NP is interpreted as the Goal: 'Elle made someone write a letter to Biera.'

²In this paper I will have nothing to say about Datives of the kind found in Japanese or Faroese. In these languages, Dative argument DPs may be promoted to subjects in passives, accompanied by a case-alternation. We should also notice that there is a third dialect of Northern Sámi, where the Causee always takes accusative case. In this dialect, only the Causee may be promoted to subject in passives, and A-scrambling of the object of the base verb is impossible.

³Further evidence is found in Control possibilities. (i) shows that PRO may correspond to a Dative DP in NSA:

(i) Mus lea várra [PRO loga-h-uvvot girji]
 1.loc be.prs.3sS hope.sg.nom read-Cause-Pass.Pst book.Nom
 'I hope to be made to read a book.'

⁴Notice that higher functional projections are not included in the tree diagrams, since they are not relevant for our discussion. Hence, when a specific tree is referred to as a surface representation, we have to assume that the DP that serves as subject has moved out of the VP-complex into Infl.

⁵Notice that nothing in particular hinges on the use of multiple specifiers. What is important is the fact that A-movement of the Theme can target some position that is higher than the position of the Causee.

⁶It is of course not inconceivable to analyze the nominative feature in Infl as optionally strong in passives for instances. However, if we assume that the nominative feature of Infl is universally weak (cf Chomsky 1995, Collins 1996), then something like (28) is required.

References

- Abney, S. P. 1987. *The English noun phrase in its sentential aspect*. Ph.D., MIT.
 Baker, M. 1988. *Incorporation, a theory of grammatical function changing*. Chicago: Chicago University Press.
 Baker, M. 1995. *The incorporation theory of morphosyntactic alternations*. McGill University: Manuscript.
 Chomsky, N. 1995. *The minimalist program*. Cambridge, Mass: MIT Press.

- Collins, C. 1996. *Local Economy* Cambridge, Mass: MIT Press.
- Freidin, R. & R. A. Sprouse. 1991. 'Lexical case phenomena.' In R. Freidin (Eds.), *Principles and parameters in comparative grammar*. Cambridge, Mass: MIT Press.
- Fukui, N. & Y. Takano. 1997. 'Symmetry in Syntax: merge and demerge,' *Journal of East Asian Linguistics*, 1-60.
- Julien, M. 1995. *Syntactic word formation in Northern Sámi*. Ph.D, Universitet i Tromsø.
- Julien, M. 1996. 'An incorporation analysis of Northern Sámi causatives.' In A. Green & Motapanyane, Virginia (Eds.), *Proceedings of the thirteenth Eastern States Conference on Linguistics*. Ithaca, NY: CLC Publications.
- Larson, R. 1988. 'On the double object construction,' *Linguistic inquiry*, 19.3: 335-391.
- Li, Y. 1990. 'X-zero binding and verb incorporation,' *Linguistic Inquiry*, 21.3: 399-426.
- Nickel, K. P. 1994. *Samisk Grammatikk* (2 ed.). Karasjok: Davvi Girji.
- Taraldsen, K.-T. 1991. 'A directionality parameter for subject-object linking.' In R. Freidin (Eds.), *Principles and parameters in comparative grammar*. Cambridge, Mass: MIT Press.
- Zaenen, A. , J. Maling. & H. Thráinsson (1990). 'Case and grammatical functions: the Icelandic case,' *Syntax and semantics*, 24: 95-136.

Nouns Are Acquired Before Verbs: Verbal Nouns in Japanese Children's Early Vocabulary

Yoshie Yamashita

Naruto University of Education

1. Introduction

Whether nouns are acquired before verbs or not has been a central issue in first language acquisition. This paper investigates this issue by using data from the acquisition of Japanese.

To date, Gentner (1982) was the first to examine this issue. Gentner (ibid.) examined several languages and reported that the noun was the first category to emerge. She attributed the primacy of nouns to their types of meanings which are perceptually more identifiable and thus make them more 'accessible' to children than verbs. This Natural Partitioning Hypothesis and other similar meaning-based explanations (e.g. Markman (1987, 1989), Au et al. (1994)) claim that children's word learning is cognitively constrained (henceforth the cognitive constraints hypothesis) and thus universal. However, recent cross-linguistic studies (Choi & Gopnik (1995) and Gopnik & Choi (1995) for Korean; Tardif (1996) for Mandarin Chinese) have questioned this widely accepted notion of noun-bias. They reported an early verb-bias and attributed it to certain properties of the input that are specific to the particular languages (e.g. SOV word order, massive noun ellipsis) (henceforth the input hypothesis). The following table (see next page) summarizes the findings from the cross-linguistic studies.

Tardif, Shatz, & Naigles (1997) examined English, Mandarin Chinese, and Italian and suggest that multiple factors may be involved in early lexical acquisition since the data does not point to one particular hypothesis. Yamashita's (1995) Japanese study also suggests the involvement of multiple factors, though it is for a different reason. The Japanese study reported that nouns were primary in children's vocabulary and were predominantly used in the input.

Table 1. Cross-linguistic studies on category development

Studies	Languages under investigation	Which category?		Explanations
		CHI	MOT	
Gentner (1982)	several languages including English	N	-	cognitive constraints hypothesis
Au et al. (1994)	English	N	N	cognitive constraints hypothesis
	Korean	N	N	
Gopnik & Choi (1995)	English	N	N	input hypothesis
	Korean	V	V	
Tardif (1996)	English,	N	N	input hypothesis
	Mandarin Chinese	V	V	
Tardif et al. (1997)	English	N	N	multiple factors
	Mandarin Chinese	V	V/N	
	Italian	N	N/V	
Yamashita (1995)	Japanese	N	N	multiple factors (multiple factors?)
Sakurai (1998)	Japanese	N	N	

However, the data also indicates that a sizable amount of baby-talk verbal nouns (e.g. *nenne* (lit.) 'do sleeping') appeared in children's very early vocabulary contradicting the cognitive constraints hypothesis which theorizes that verbal nouns having verb-like meanings are not expected to emerge early.

The present study examines the issue of why verbal nouns do emerge early among Japanese-speaking children.

2. The Study

Why do verbal nouns emerge earlier than verbs, even though they have the same type of meanings (i.e. actions or changes of state) and verbs are more frequently used in the input? Is it because verbal nouns tend to occur in a more salient position than verbs? Is it because verbal nouns have less morphological variations than verbs? Or, is it because verbal nouns tend to be more focused pragmatically than verbs?

2.1. Data

The data was taken from the longitudinal speech sampling used in my previous study. The child R's interactions with his caregivers were tape-recorded for approximately an hour per month from the ages of 16 through 22 months.

2.2. Analysis

The data was first analyzed for the child's vocabulary development and then for the caregivers' speech. The caregivers' speech was analyzed for the uses of nouns, verbal nouns, and verbs - specifically in terms of their frequency, saliency (i.e. how often they are used in the utterance-final position), morphological variation, and pragmatic focus.

2.3. Results - results from the child's speech

The overall results from the child's speech indicate that nouns were the first category to emerge and verbal nouns emerged earlier than verbs.

R began to produce nouns at around 16 months of age, but he did not produce verbs until around 22 months. Nouns were the primary category in R's vocabulary growth throughout the entire recording period. R's vocabulary developments are illustrated in Figures 1 and 2 below. In these figures nouns are placed at the left most, verbal nouns are in the middle, and verbs are at the right most.

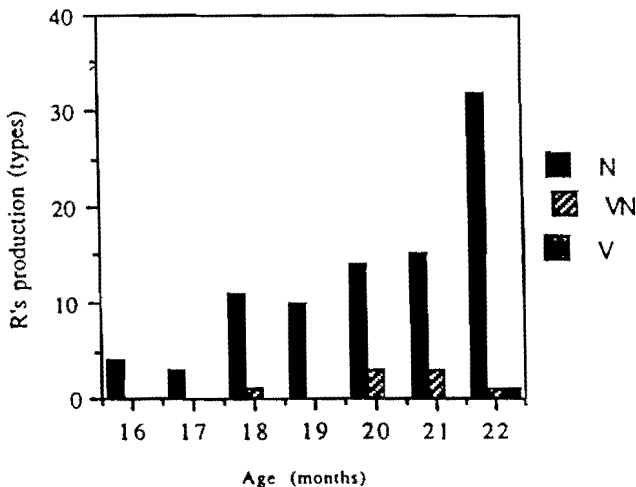

Figure 1. R's vocabulary development (Types)

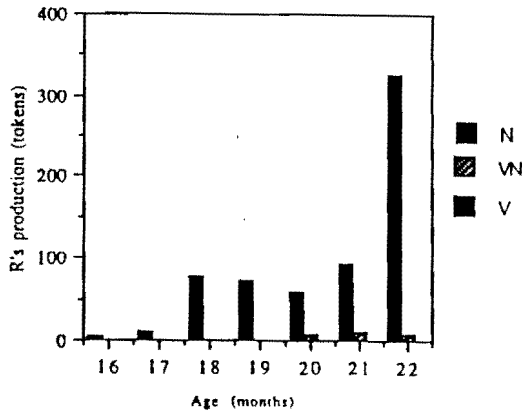

Figure 2. R's vocabulary development (Tokens)

2.4. Results - results from caregivers' speech

The overall results from caregivers' speech were neither consistent within the different factors (see 2.2), nor with the reported variations in the proportions of nouns, verbal nouns, and verbs in the child's speech. The results will be reported in terms of different factors.

2.4.1. Frequency

In terms of frequency, nouns were the predominant category for both types and tokens in R's caregivers' speech. Between verbal nouns and verbs, verbs were always more predominantly used than verbal nouns. Figures 3 and 4 illustrate frequency of these categories in R's caregivers' speech.

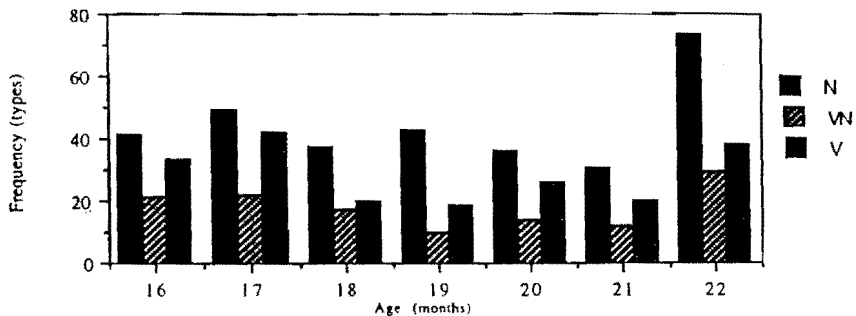

Figure 3. The number of types of N, VN, and V in R's caregivers' speech

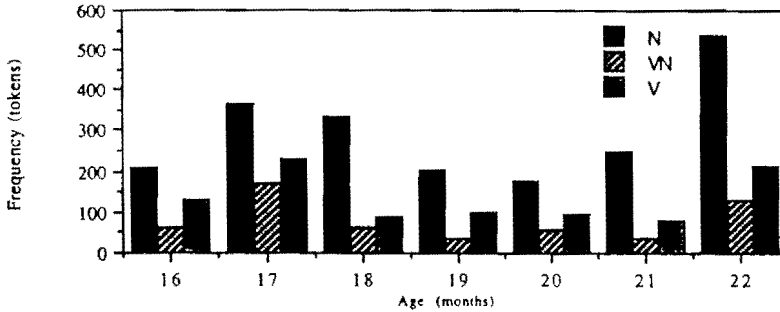

Figure 4. The number of tokens of N, VN, and V in R's caregivers' speech

2.4.2. Saliency

The saliency effect was measured through tabulating how often each category word occurred utterance-finally in multi-word utterances. The results from R's caregivers' speech indicate that nouns occurred in the salient position more frequently than verbs or verbal nouns except in the recordings at 16 and 18 months. These results are illustrated in Figure 5.

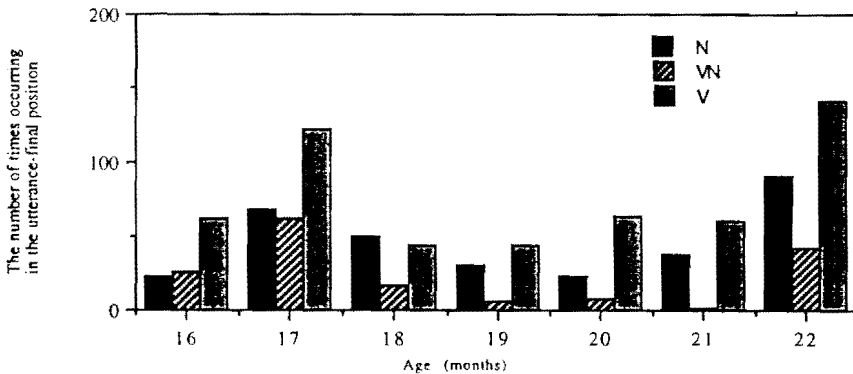

Figure 5. The number of times when N, VN, and V occurred in the utterance-final position in R's caregivers' multi-word utterances

The mean scores indicate that verbs occurred most frequently in the salient position (i.e. 76.1), the second most frequently used category was nouns (45.7), and the least frequent one was verbal nouns (i.e. 23.1).

2.4.3. Morphological variation

Morphological variation was measured by looking into how many different forms were used for the same words. Diminutives and case markers were included for the noun variation. The results indicate that nouns had the least morphological variation followed by verbal nouns, and nouns had the most morphological variation.

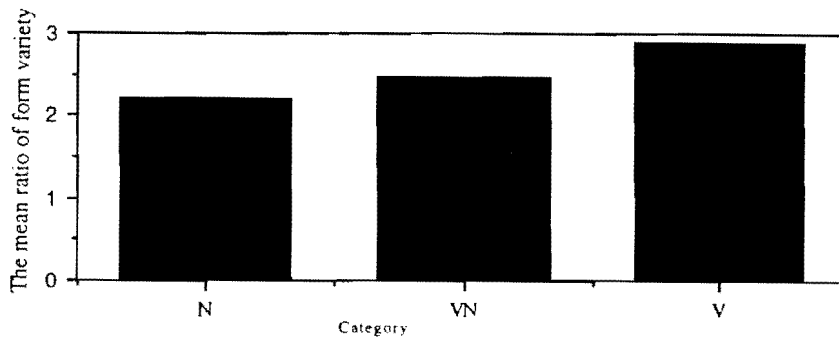

Figure 6. The mean ratio of form variety for N, VN, and V in R's caregivers' speech

Figure 6 is to be interpreted as for each noun, different forms of the nouns appeared at least once with the ratio of 1.0 to 2.2.

2.4.4. Pragmatic factors

Partially following Tardif, Shatz, & Naigles (1997), the pragmatic focus was measured by which category words were used in reflective-questions, requests, and test questions. The more frequently they were used in these types of utterances, the more pragmatic focus they were given. These types were sorted out when they were used to elicit responses from the child explicitly. The elicitation which reflects caregivers' expectations of the child was further subdivided into verbal and actional. Thus, for example, when caregivers asked questions which were reflective of the child's previous actions/utterances or anticipated actions, which category word (i.e. N, VN, or V) was in use was

recorded. For requests, when caregivers used the request form to elicit verbal utterances (e.g. *manma itte* 'say food') or actional responses (e.g. *booru totte* 'get me the ball'), the category label was recorded accordingly.

The results from R's caregivers' speech are summarized in Table 3.

Table 3. The pragmatic focus for N, VN, and V based on the mean number of questions and requests which explicitly elicited verbal/actional responses from R

		N	VN	V
Reflective Q	Verbal	8.4	2.1	2.8
	Actional	1.9	11.7	4.6
		10.2	13.9	7.4
Request	Verbal	6.4	6.0	4.6
	Actional	0	8.0	16.1
		6.4	14.0	20.7
Test Q		52.9	0	0
Total		69.6	27.9	28.1
N:VN:V		2.49	1.00	1.007

Table 3 indicates that for reflective questions, verbal nouns were most frequently used followed by nouns, and verbs were least frequently used. On the other hand, for requests, verbs had the most focus, followed by verbal nouns and nouns had the least pragmatic focus. In all the test questions, only nouns were used. Overall, nouns were most frequently used for the purpose of eliciting responses, and thus had the most pragmatic focus. There was not much difference between verbal nouns and verbs in tabulating the pragmatic focus (1.00 : 1.007).

For both reflective questions and requests, verbs were most frequently used, followed by verbal nouns, and nouns were least frequently used. The mother asked fewer test questions eliciting responses with nouns, compared to R's caregivers. Consequently, the overall results remain the same as those from the reflective questions and requests.

Table 4 (next page) summarizes the relative orderings of nouns, verbal nouns, and verbs in the vocabulary development of the two children, and the relative degrees of frequency, saliency, morphological variation, and pragmatic focus among these categories.

Table 4. Summary table

		Child R
CHI		N > VN > V
MOT	Frequency	N > V > VN
	Saliency	V > N > VN
	Morph. Variation (least to most)	N > VN > V
	Pragmatic focus	N > V ≥ VN

3. Discussion

Four variables in the input were considered to be potential factors for determining which one emerges earlier than others among nouns, verbal nouns, and verbs in children's early vocabulary.

As shown in Table 4, the data indicates that frequency cannot be the sole factor since the ordering of dominance in terms of frequency did not match the ordering of emergence in children's vocabulary. Saliency may be the least affecting variable since verbs were found to be the most salient category which was in fact the latest category to emerge in the child's vocabulary.

Morphological variation may have the most potential since nouns were found to be with the least morphological variation followed by verbal nouns, and verbs had the most morphological variation which may have been the cause of the late emergence of verbs. Since this ordering indeed matches the ordering of emergencies of nouns, verbal nouns, and verbs in the child's vocabulary, this factor can be the most affecting one among the four. However, as the differences among the three categories were minimal (see Figure 6), the results reported here cannot be conclusive.

The pragmatic focus was considered along with the other three factors as a possible determinant for the early emergence of verbal nouns in this study. Since verbal nouns are commonly used in daily, social routines by adults, it was hypothesized that certain expressions which were pragmatically more focused may have caught the child's more attention and thus facilitated his learning of such expressions.

There were indeed so many instances of social routines which involved verbal noun expressions. For example, the child responded by lowering his head when he was asked to do *arigatoo* (lit) 'do thank you', by putting his hands together and lowering his head when he was asked to do *gotisoosamadesita* (lit.) 'do "It was a good meal" and so forth. These instances indicate that although the child did not produce the words, he understood their meanings since they were repeatedly used by his caregivers in his daily activities.

However, these words and phrases of social routines occurring in the form of verbal nouns were not included in the analysis since it seemed that the learning

of such expressions, though linguistically resembling previously identified verbal nouns (e.g. *nenne* 'do sleeping'), involve more of extra-linguistic factors than pragmatic factors. In addition, since the child did not produce these expressions during the recording periods, their inclusion for the input analysis only does not seem worthwhile. Consequently, the results from the analysis for the pragmatic focus did not show sharp differences among nouns, verbal nouns, and verbs either.

This study attempted to find determinants for the early emergence of verbal nouns (and the late emergence of verbs) in Japanese early lexical acquisition. Although the data used in this study was from only one child and thus the findings obtained here are very preliminary, further examination based on data from more children along the similar line may give us a clearer picture of why certain categories emerge earlier than others in children's very early vocabulary.

References

- Au, T. K., Dapretto, M. & Song, Y. 1994. 'Input vs. constraints: Early word acquisition in Korean and English' *Journal of Memory and Language* 33: 567-582.
- Choi, S. & Gopnik, A. 1995. 'Early acquisition of verbs in Korean: A cross-linguistic study' *Journal of Child Language* 22: 497-529.
- Gentner, D. 1982. 'Why nouns are learned before verbs: linguistic relativity versus natural partitioning' In S. A. Kuczaj (ed.), *Language development. Vol. 2: Language, thought, and culture*. Hillsdale, NJ: Erlbaum.
- Gopnik, A. & Choi, S. 1995. 'Names, relational words, and cognitive development in English and Korean speakers: Nouns are not always learned before verbs' In M. Tomasello & W. E. Merriman (eds.), *Beyond names for things*. 63-80. Hillsdale, NJ: Erlbaum.
- Markman, E. M. 1987. 'How children constrain the possible meanings of words' In U. Neisser (ed.), *Concepts and conceptual development: Ecological and intellectual factors in categorization*. New York: Cambridge University Press.
- 1989. *Categorization and naming in children*. Cambridge: Cambridge University Press.
- Okubo, A. 1982. *Yooji no kotoba shiryoo* (The child's language data). Tokyo: Kokuritsu Kokugo Kenkyuujo.
- Sakurai, C. 1998. 'Nihongo o bogo to suru kodomo no goi shutoku ni tsuite' (Language development among Japanese-speaking children). Paper presented at the 116th bi-annual meeting of Nihon Gengo Gakkai. Tokyo: Keio University.
- Tardif, T. 1996. 'Nouns are not always learned before verbs: evidence from Mandarin speakers' early vocabularies' *Developmental Psychology* 32 (3): 492-504.
- Tardif, T., M. Shatz, & L. Naigles. 1997. 'Caregiver speech and children's use of nouns versus verbs: A comparison of English, Italian, and Mandarin' *Journal of Child Language* 24: 535-565.
- Yamashita, Y. 1995. *The emergence of syntactic categories: Evidence from the acquisition of Japanese*. Ph.D. dissertation. University of Hawai'i at Manoa.

- Tardif, T., M. Shatz, & L. Naigles. 1997. 'Caregiver speech and children's use of nouns versus verbs: A comparison of English, Italian, and Mandarin' *Journal of Child Language* 24: 535-565.
- Yamashita, Y. 1995. *The emergence of syntactic categories: Evidence from the acquisition of Japanese*. Ph.D. dissertation. University of Hawai'i at Manoa.

It is easy to see that the principles in (8) describe the interpretations of the sentences in (3)-(5) correctly.

3. A Derivational Approach

The minimalist reformulation of the binding principles entails the following:

- (9) 1. phrases are defined as either anaphors, pronominals, or R-expressions;
2. interpretive procedures at LF recognize the status of phrases as anaphors, pronominals, or R-expressions;
3. the interpretation procedure at LF calculates the size of the local domain D_i ;
4. the interpretation procedure at LF recognizes the relation c-command;
5. the interpretation procedure operates on the entire LF-representation yielded by C_{HL} .

I will refer to the interpretation procedure in (9) as an 'all at once' operation: the entire LF-representation is processed by the interpretational procedure at LF.

(9.1) and (9.2) are uncontroversial.⁵ (9.3) is generally tacitly assumed, and apparently unproblematic. But (9.4) and (9.5) raise interesting questions.

One such question is: how is it that the LF interpretation procedure only considers elements c-commanding α as potential antecedents for α ? Following Epstein (1995), we are able to provide a principled answer to this question. Epstein argues that grammatical relations are restricted to pairs of elements (α, β) , where α c-commands β , because only α enters into an operation of merger with β (or a node containing β).

To appreciate this result, consider the phrase structure building process in the Minimalist Program (Chomsky 1995:241f).

Whereas in previous stages of generative grammar phrase structure was the result of the operation of context free rewrite rules, combined with a process of lexical insertion at the terminal nodes, the Minimalist Program makes no formal distinction between lexical insertion and the generation of structure. Structure is the result of two elements *merging*. Merger is a derivational process, yielding successive stages of phrase structure 'under construction', and subject only to a limited set of basic conditions. One of these conditions specifies that α cannot be merged to a subpart of β (the *extension condition*, Chomsky 1995:190).⁶

Epstein (1995) notes that at any given stage in the derivation (say, the point where α has merged with β), α c-commands β , as well as every term contained in β . But elements added by later operations of Merge are never c-commanded by α . The definition of c-command then follows if the 'c-command properties' of α are fixed *once and for all* at the point in the derivation where α is merged to the structure.

We can now say that the LF interpretation procedure is sensitive to the 'c-command properties' of the elements in the LF-representation. However, Epstein's observations raise the following question. Can we, by analogy to the

(3) shows that *himself* refers to a noun phrase within domain D (*John* in (3a), none in (3b)). (4) shows that *him* may refer to a noun phrase outside domain D (*Bill* in (4a)), but not to a noun phrase within domain D (*John* in (4a) and (4b)). (5) shows that *he* cannot refer to the same entity as *John*, regardless the domain D.

In classical binding theory, the principles in (2) are generally taken to apply at S-structure (Chomsky & Lasnik 1995:106). (6) shows that principle A need not be satisfied at D-structure:

- (6) a D-structure: [_D [e] seems to *himself* [*John* to be intelligent]]
 b S-structure: [_D *John* seems to *himself* [[t] to be intelligent]]

(7) shows that principle C applies prior to LF (assuming Quantifier Raising of the quantified expression *everyone that John knows* at LF):

- (7) a S-structure: * *He* admires [everyone that *John* knows]
 b LF [everyone that *John* knows] [*he* admires [t]]

Ignoring many concomitant issues, this summarizes the classical binding theory.

2. Minimalist Binding Theory

From the perspective of the Minimalist Program, two aspects of the classical binding theory are not acceptable.

First, the definition of *binding* in (2) relies crucially on the notational convention of indexing (cf. Chomsky 1995:217 fn 53). Coindexing *expresses*, rather than *defines*, the existence of a binding relation between two phrases (cf. Zwart 1997a).³

Second, the Minimalist Program aims to describe phenomena in terms of requirements holding at the interfaces (PF and LF) between the grammar (the computational system C_{HL}) and components processing sound and meaning (Chomsky 1995:222f). This suggests that the principles of the binding theory be taken as interpretive principles applying at LF (see Chomsky 1995:192-193, 205-211).⁴

Both considerations conspire to yield a different formulation of the principles of the binding theory (Chomsky 1995:211):

- (8) a If α is an anaphor, interpret it as coreferential with a c-commanding phrase in D.
 b. If α is a pronominal, interpret it as disjoint from every c-commanding phrase in D.
 c. If α is an **R-expression**, interpret it as disjoint from every c-commanding phrase.

A Dynamic Theory of Binding

Jan-Wouter Zwart

NWO/University of Groningen

Binding Theory (Chomsky 1981:183ff) is generally taken to describe representational conditions on the distribution of noun phrase types. Within the Minimalist Program, where all conditions are output conditions, the relevant representation should be Logical Form (Chomsky 1995:208). This paper argues for a different view, where the principles of the Binding Theory fall out from a dynamic derivational process of assigning reference to noun phrases. The process is dynamic in that it proceeds in tandem with the structure building process of Merge (Chomsky 1995:226).¹

1. Classical Binding Theory

This paper starts from the classical binding theory of Chomsky 1981 (p. 183ff; see also Chomsky 1986:164ff, Chomsky & Lasnik 1995:100). I take the following to summarize the principles of the classical binding theory:

- (1) For a local domain D :
 - a. An anaphor is bound in D
 - b. A pronoun is free in D
 - c. An R-expression is free

Binding (being bound) is defined as in (2) (Chomsky 1981:184):

- (2) α binds β iff α c-commands β and α and β are coindexed²

The *local domain D* relevant to the principles of the binding theory is defined in various ways. The core intuition appears to be that D is the minimal maximal projection dominating the anaphor-pronoun that contains either *tense* or a *subject* (e.g. Lasnik 1989:1).

The principles of the binding theory describe the interpretation of the italicized noun phrases in (3):

- (3) a. Bill believes that [_D *John* knows *himself* well]
b. * *Bill* believes that [_D *Mary* knows *himself* well]
- (4) a. *Bill* believes that [_D *John* knows *him* well]
b. * *Mary* believes that [_D *John* knows *him* well]
- (5) a. * *Mary* believes that [_D *he* knows *John* well]
b. * *He* believes that [_D *Mary* knows *John* well]

definition of c-command as a function of Merge, define the binding relations between elements as a function of Merge as well? In other words, can we replace the 'all at once' operation in (9)(especially (9.5)) by a stepwise, derivational procedure? This would allow us to dispense with the LF procedure for the interpretation of noun phrases (i.e. for binding).

I argue in this paper that we can, and that there are in fact empirical arguments in support of a derivational definition of binding relations.

4. Inner and Outer Indices

Before proceeding, let me explain a notational device which is employed here (adapted from Heim 1992, discussed in Tancredi 1992).

The 'reference' of noun phrases may be considered a) autonomously and b) as a function of a syntactic (binding) relation.⁷ Heim (1992) and Tancredi (1992) employ indices to express both types of reference, with *inner indices* representing the autonomous referential properties of noun phrases, and *outer indices* representing referential properties as a function a grammatical relation. All noun phrases bear an inner index, as in (10a). I propose that only dependent elements bear an outer index, as in (10b):⁸

- (10) a. [NP_i]
 b. [NP_i]_j

All noun phrases, including anaphors and pronominals (including the empty element *pro*) represent an individual concept, hence bear an inner index in our notation. Anaphors and pronouns differ from R-expressions in that the individual concept represented by anaphors and pronouns is *variable*, whereas with R-expressions, it is *fixed* (ignoring variability provided by the discourse situation). The 'referentiality' of pronouns and anaphors is expressed in the selection of their morphosyntactic features (proximal, 3d person, plural, masculine, etc.), which restrict the properties of the individual concept represented by the anaphor or pronoun. Binding links these variable referential elements to fixed referential elements. The (more restricted) referential properties so acquired are represented by outer indices in our notation.

The characterization of pronouns and anaphors as variable referential elements suggests a definition of noun phrase types as in (11):

(11)

referential	variable	type
+	+	anaphor, pronoun
+	-	R-expression
-	+	(does not exist)
-	-	PRO

See Zwart (1997a) for further discussion

5. Index Assignment

The process of index assignment proposed here is intended as a model of how the grammar tracks referential properties of noun phrases. The core of the proposal is that these referential properties are fixed at the moment of merger.

The index assignment procedure involves the following steps:

- (12)
1. Assign a different inner index to every noun phrase α at the point in the derivation where α is merged.
 2. Assign the inner index of α as the outer index of a variable referential element δ at the point in the derivation where α is merged with β dominating δ .

The index assignment procedure expresses that obviation is the norm (as in Lasnik 1976), the difference with earlier implementations being that obviation is ensured in a bottom-up fashion, rather than in a top-down fashion.

Thus (13a), repeating part of (5a), is derived by the succession of steps in (13b):

- (13) a. He knows John well
- b.
1. MERGE *knows* with *John*, yielding {knows, John}
 ASSIGN INDEX to *John* {knows, John₁}
 2. (other steps, yielding XP containing *John*)
 3. MERGE *he* with *XP*, yielding {he, XP}
 ASSIGN INDEX to *he* {he₂, XP}

He in (13a) can receive an outer index from a newly merged noun phrase, but that index is different from the index of *John*, by (12.1). Consider (14a), derived by the steps in (13b) and the additional steps in (14b):

- (14) a. *Bill* says *he* knows John well
- b.
1. (steps yielding YP containing *he*₂ knows John, well)
 2. MERGE *says* with YP yielding {says,YP}
 3. (steps yielding ZP containing *says he*₂ knows John, well)
 4. MERGE *Bill* with ZP yielding {Bill,ZP}
- ASSIGN INDEX to *Bill* yielding {Bill,₃ZP}
- ASSIGN OUTER INDEX 3 to *he* yielding [he₂]₃

Here the circumstance that *he* is linked to *Bill* is expressed by the additional outer index of *he*, which is identical to the (inner) index of *Bill*. The example shows that different inner and outer indices do not necessarily conflict. The outer index 3 further restricts the inherent reference of *he*, represented by the inner index 2.

6. The Principles of the Binding Theory

The principles of the Binding Theory can be reformulated in terms of the indexing procedure in (12).

6.1 Principle C

Principle C follows straightforwardly from the obviative indexing procedure in (12.2). There is a little more to it, though, since Principle C is not bled by movement (the 'reconstruction' property of Principle C).

In (15a), derived via the steps in (15b), the inner index and the outer index of *he* conflict (angled brackets surround copies of moved elements).

- (15) a. * *John*, *he* knows <*John*> well
- b.
1. (steps yielding YP containing *he* knows John, well)
 2. MERGE *John* with YP yielding {John₁,YP}
- ASSIGN OUTER INDEX 1 to *he* yielding [he₂]₁

Here the indexing follows the principles in (12), still (15a) is ungrammatical. The index notation employed here obscures that the reference of *he* in (15a) is not just different from the reference of *John*, but in fact complementary to it. We could express this by writing the outer index of *he* as *-1*, indicating that it is biased to be complementary to the index of the R-expression it c-commands. After step b.2 in (15), assignment of the outer index of *John* to *he* yields an object like (16), expressing referential properties which are arguably not interpretable:

- (16) [he₂]₋₁

Thus, it appears to be a defining characteristic of R-expressions that they force the indices on newly merged elements to be complementary to their own index.

6.2 Principle B

Principle B operates identical to Principle C within the local domain D. Thus, within the domain D (not further defined here), newly merged noun phrases receive a different index from pronominals already contained in the structure:

- (17) a. John knows him well
- b.
1. MERGE *knows* with *him*, yielding {knows.him}
 - ASSIGN INDEX 1 to *him*, yielding [him₁]
 2. further steps, yielding XP containing *knows him*₁
 3. MERGE *John* with XP, yielding {John, XP}
 - ASSIGN INDEX 2 to *John*, yielding John₂

Since *John* cannot have an outer index (its reference is already fixed), raising of *him* across *John*, as in (18), has no effect on the interpretation of (17a):

- (18) Him₁ John knows <him> well

Therefore it is not clear whether pronominals actually require the index of newly merged noun phrases to be complementary to their own index. Outside domain D, such a requirement certainly does not apply, as the derivation of (14a), here repeated as (19), shows (the domain D uncontroversially identified with the embedded clause):

- (19) Bill₃ says [_D [he₂], knows John₁ well]

In (19), the indices 2 and 3 must not conflict, or else the sentence would be uninterpretable (cf. the discussion around (15)).

6.3 Principle A

Principle A requires anaphors to adopt as their outer index the index of a newly merged noun phrase within domain D:

- (20) a. *John knows himself*
- b.
1. MERGE *knows* with *himself*, yielding {*knows*, *himself*}
 - ASSIGN INDEX 1 to *himself*, yielding [*himself*₁]
 2. further steps, yielding *XP* containing *knows himself*₁
 3. MERGE *John* with *XP*, yielding {*John*, *XP*}
 - ASSIGN INDEX 2 to *John*, yielding *John*₂
 - ASSIGN INNER INDEX 1 to *himself*, yielding [*himself*₁]₂

The strongest hypothesis appears to be that anaphors need to adopt as their outer index the index of the *next* noun phrased merged to the structure.⁹ This derives much of the locality features of anaphor binding, but not quite, in view of the impossibility of having anaphors in the position of subject of a tensed clause (=domain D):

- (21) * *John knows that* [_D *himself/heself* is intelligent]

Apparently, the ‘search for an outer index’ is abandoned as soon as the structure is extended beyond a local domain D. As a result, the subject of a tensed clause can never be interpreted as an anaphor, and languages will generally lack morphological spell outs of nominative anaphors (cf. note 5).¹⁰

6.4 Summary

The preceding discussion suggests, perhaps prematurely, that the LF-interpretation procedure of the minimalist binding theory can be reformulated as a derivational reference fixing procedure, working in tandem with the structure building process Merge. The reference fixing procedure involves the following features:

- (22) *Features with the status of virtual conceptual necessity:*

1. Universal Grammar (UG) distinguishes fixed referential elements (R-expressions) and variable referential elements (anaphors and pronominals).
2. Variable referential elements get their reference fixed by other noun phrases merged with the projection containing them.
3. The reference fixing procedure is sensitive to the definition of local domains.
4. Within the class of variable referential elements, UG distinguishes locally fixed referential elements (anaphors) and locally variable referential elements (pronominals).
5. Languages differ in whether they acknowledge the distinction between locally fixed referential elements and locally variable

referential elements in the spell out operation (mediated by the morphology component).

(23) *Theoretically contingent features*

6. The reference of variable referential elements is fixed at the point in the derivation where the fixing element is merged with the projection containing the variable referential element.
7. Local domains are determined concomitantly with the structure building operation Merge (instead of read off of the LF-representation).

Point 6 is the crucial hypothesis investigated in this paper. Point 7 is a necessary consequence of this hypothesis. It gains plausibility from the consideration that local domains are generally determined on the basis of an opacity factor (tense or a subject), the presence of which could seal off the local domain as soon as it is merged to the structure.¹¹

The discussion so far has ignored the question of whether nonlocally 'bound' pronouns acquire a fixed reference by the same process as anaphors. I have tacitly assumed that they do (cf. the discussion of (14)), but points 1-7 make no explicit statement about the mechanism by which pronouns may get their reference fixed (certainly not obligatorily or exclusively as a function of the operation Merge). I will continue to assume that pronouns, if 'bound' by c-commanding antecedents, are 'nonlocal anaphors', while noting that this is probably incorrect and that the system as described so far is unclear about this point.

7. Empirical Support for the Derivational Approach

The derivational approach to binding developed here is empirically supported by curious exceptions to Principle C reported on by Fiengo & May (1994:265), and Fox (1995), illustrated in (24), using conventional indexing:

(24) I bought him_i everything John_i wanted me to

In (24), the basic obviation required by the R-expression *John* is lifted without loss of grammaticality. (24) contrasts with the expected Principle C violation (25):

(25) * I bought him_i everything John_i wanted

The contrast between (24) and (25) obviously corresponds with the presence vs. absence of 'verb phrase ellipsis', (24) being interpreted as (26):

(26) I bought him_i everything John_i wanted me to buy him_i,

The standard analysis of VP-ellipsis since Williams (1977) involves generation of an empty VP at D-structure and reconstruction of the contents of that VP on the basis of an 'antecedent' VP at LF. Under this analysis of VP-ellipsis, the absence of a Principle C violation is unaccounted for.¹²

As argued by VandenWyngaerd and Zwart (1998), the standard analysis of VP-ellipsis is not easily reproduced within the minimalist approach.

The standard analysis relies crucially on a top-down structure building process involving context free rewrite rules, and on a distinction between structure building and lexical insertion. As a result, empty structure can be generated by the rewrite rules (such as an empty VP¹³) but ignored in the lexical insertion process. In this approach, LF operations (like reconstruction) are indispensable to ensure the correct interpretation of the empty structure.

In the minimalist approach, no such distinction between structure building and lexical insertion is made. As a result, empty structure has to be produced by merging empty elements, or, alternatively, no empty structure is generated and ellipsis results from deletion (i.e. non spell out) of duplicated material at PF.

The PF deletion approach is undoubtedly more attractive from the minimalist point of view. It is also supported by Tancredi's (1992) observation that VP-ellipsis is semantically indistinguishable from VP-deaccenting, suggesting that ellipsis is just an extreme form of deaccenting.

By consequence, we may assume that constructions like (24) involve a full VP *buy him* in the most deeply embedded clause right from the start of the derivation. Applying the derivational theory of binding now yields a stage where the indexing is as in (27):

(27) everything John₂ wanted me to buy [him₁]₂

Anticipating the discussion of how indices are assigned in ellipsis contexts, it is clear that the derivation of (24) cannot treat the next instantiation of *him* as independent of the *him* already present in the structure. So let us assume that in precisely these contexts, the principle that every noun phrase receives an independent index is lifted (independently of the presence of an intervening R-expression like *John* in (27)). The indexing of (24) will then come out as in (28):

(28) I bought [him₁]₂ everything John₂ wanted me to buy [him₁]₂

The bottom-up structure building procedure in effect makes the elliptical VP the 'antecedent' for the overt VP, a reversal of traditional terminology.¹⁴ It is precisely the 'antecedence' of the elliptical VP that makes lifting the obviation requirement possible.

On these assumptions, the existence of constructions like (24), where Principle C is scorned, presents clear empirical support for the derivational theory of binding under investigation in this paper. A representational theory of binding,

where reference is tracked in a top-down fashion (mostly tacitly), could not account for the dependence of the anti-obviation on the elliptical VP.¹⁵

8. Some Further Issues.

8.1 Superraising

Lasnik (1985) discusses locality conditions on A-movement in the light of examples like (29):

(29) * John_i seems that [_D he_i likes t_i]

In (29), *John* is raised out of the embedded clause and binds the pronoun *he* from its derived position. The trace of *John* is now coindexed with a c-commanding antecedent, and is by sheer coincidence bound within the local domain D. Since A-movement traces are regarded as anaphors in that they must be locally bound (Chomsky 1982:20), the ungrammaticality of (29) is unexplained.¹⁶

Lasnik (1985) and Lasnik & Saito (1992:133f) propose to describe locality conditions on A-movement not in terms of the principles of the Binding Theory, but in terms of locality conditions on chain links. This approach is essentially also adopted in Rizzi (1991), in terms of 'relativized minimality', and Chomsky (1995:181), in terms of a 'shortest move' requirement.

From the present perspective, the argument based on examples like (29) lacks force. The obviation principle C requires *he* in (29) to be conindexical to *John* at the moment of its merger to the structure, so that assignment of the index of *John* as the outer index of *he* yields an uninterpretable object of the type of (16).

Importantly, the strict locality condition on A-movement entailed by the 'shortest move' requirement of Chomsky (1995:181) follows straightforwardly from the strictest version of Principle A of the Binding Theory as reformulated here. If the outer index of an anaphor must be assigned by the next noun phrase merged to the structure, and if NP-traces are anaphors, it follows that no noun phrase can intervene between the anaphor/NP-trace and its antecedent.^{17,18}

8.2 Reconstruction

Barss (1986) discusses examples like (30), where *himself* is bound by either *John* or *Bill*:

- (30) a. Which pictures of himself does John think that Bill really likes?
 b. John wonders which pictures of himself Bill really likes

Apparently, *himself* can 'pick up' an antecedent in its basic position to the right of *likes* as well as in the derived position where we see it in (30b). Binding of *himself* by *John* in (30a) then follows if *which pictures of himself* has moved

through that derived position on its way to the left periphery of the sentence. Interpretation of *himself* through a position formerly occupied by it in the course of the derivation is referred to as *reconstruction* (not to be confused with reconstruction of the contents of an empty VP at LF, cf. section 7).

The interpretation of the sentences in (30) where *himself* is bound by *John* is problematic for the derivational approach to binding under scrutiny here. The outer index of *himself* should be equated with the index of the first noun phrase merged to the structure, *Bill*, at all times.

Importantly, *himself* in 'picture noun contexts' poses more problems for the Binding Theory (cf. Postal 1971:188). For example, in (31), *himself* is exceptionally bound from outside the local domain D:

(31) John_i said that [_D [several pictures of himself_i] would be on sale]

The Dutch anaphor *zichzelf* behaves differently, not only when compared to (31), but also when compared to (30):

(32) * Jan_i zei dat [_D [verschillende foto's van zichzelf_i]]
 John said that several pictures of himself
 te koop waren]
 for sale were

(33) a. * Welke foto's van zichzelf_i zei Jan_i dat Piet
 which pictures of himself said John that Pete
 leuk vond ?
 nice found

b. * Jan_i vroeg zich af welke foto's van zichzelf_i Piet
 John wondered which pictures of himself Pete
 leuk vond
 nice found

Zichzelf behaves as predicted by the derivational theory of binding: it can only be bound by the first noun phrase merged to the structure containing it (*Piet* in (33)), and it must be bound within domain D (illustrated by (32)).

Outside of picture noun contexts, *himself* behaves as expected (Barss 1986:156):

(34) a. * John_i wondered why himself_i Mary didn't like
 b. * John_i wondered how proud of himself_i Mary really was
 c. * John_i thinks that a critic of himself_i Mary became

This suggests that something special is going on with *himself* embedded in nonpredicative noun phrases. Since the same effect does not show up with unsuspected anaphors like Dutch *zichzelf*, it has been assumed that *himself* in English is in fact ambiguously a true anaphor and a logophor (a long-distance, subject-oriented pronominal, Dutch *'mzelf*) (cf. Koster 1985). The long-distance binding facts in picture noun contexts would involve logophoric *himself*.

If so, we may maintain the strong claim that anaphors may never pick up an antecedent from a derived position. This in turn is strong evidence in support of the theory of binding investigated here, where binding relations are determined once and for all in conjunction with the operation Merge.

8.3 Strict and Sloppy Identity

A question arises as to how strict and sloppy identity may be described in the system outlined here.

Strict and sloppy identity can be illustrated through the two interpretations in (36) of the example in (35):

(35) John thinks he is a genius, and so does Bill <think he is a genius>

- (36) a. John thinks *John* is a genius, and Bill thinks *John* is a genius
 b. John thinks *John* is a genius, and Bill thinks *Bill* is a genius

(36a) is the strict reading of (35), (36b) the sloppy reading.

Since constructions involving strict/sloppy ambiguity invariably involve ellipsis, we must assume (following the discussion in section 7), that the elliptical material is present from the start of the derivation. It is indicated in angled brackets in (35).

A sloppy reading is forced when the dependent element (the pronominal) is an anaphor:¹⁸

(37) John loves himself, and so does Bill <love himself>

This follows from Principle A, stating that the outer index of an anaphor must be determined by a newly merged noun phrase within domain D (section 6.3). In (37), the only potential antecedent for the occurrence of *himself* in the elliptical part is *Bill*, precluding the strict interpretation where *himself* is bound by *John*.

Pronouns differ from anaphors in that they do not *require* the outer index to be determined on the basis of another noun phrase merged to the projection containing the pronoun. Thus, whereas (38) is perfectly acceptable, with the pronoun *he* adopting the outer index of *Bill*, *he* is free to refer to a noun phrase that is not merged to a projection containing *he* (39a), or even to a person known through the discourse only (39b):

- (38) Bill_i says [_D [he₁]₂ knows John well]
 (39) a. [Bill_i's mother] says [_D [he₁]₂ knows John well]
 b. (*pointing at Bill_i*) [_D [He₁]₂ knows John well]

Let us refer to this inherent ambiguity in pronouns by saying that the outer index of a pronoun is either *relative* (i.e. determined on the basis of Merge, as in (38)), or *absolute* (i.e. determined through other means, as in (39)).²⁰ It is easy to see that an absolute outer index precludes a sloppy identity interpretation.

(40) repeats the strict/sloppy identity pattern of (35) with the relative/absolute status of the outer indices marked:

- (40) a. John thinks [he]_{ABS} is a genius, and so does Bill <think [he]_{ABS} is a genius>
 b. John thinks [he]_{REL} is a genius, and so does Bill <think [he]_{REL} is a genius>

As before, the occurrence of *he* in the first conjunct is an exact match of the occurrence of *he* in the elliptical second conjunct. The inherent ambiguity of pronouns (as either relative or absolute) automatically derives the strict (40a) and sloppy (40b) interpretation of these sentences. In (40a), the pronoun has some fixed reference, indicated by the absolute character of the outer index, which is the same for both occurrences of the pronoun.²¹ In (40b), the outer index of each occurrence of the pronoun must be determined on the basis of a newly merged noun phrase, yielding different interpretations for each occurrence of the pronoun (i.e., a sloppy reading).²²

This much is automatic and fully understandable assuming the bottom-up reference tracking procedure under investigation here. As soon as a pronoun is merged to the structure, a decision is made as to the relative or absolute status of its outer index. If relative, the pronoun behaves like a nonlocal anaphor, and we obtain a sloppy interpretation under coordination and ellipsis. If absolute, the outer index must remain constant under coordination and ellipsis (regardless the mechanism by which it is ultimately determined), yielding a strict interpretation.

8.4 A Remaining Problem

The reference tracking procedure discussed here is unable to account for the following contrast:²³

- (41) a. Which report that *John* revised did *he* submit?
 b. * Which report that *John* was incompetent did *he* submit?

Assuming that the sentences in (41) derive from the partial representations in (42), *he* must be understood as having an outer index that is complementary to the index of *John*:

- (42) a. [he_i]_i did submit which report that John_i revised
 b. [he_j]_i did submit which report that John_i was incompetent

Consequently, the coreference indicated in (41a) could never be obtained.

There is no immediate way out of this problem.²⁴ Possibly the premiss that the sentences in (41) are derived from the representations in (42) is false. An informal suggestion would be that (41a), for example, is interpreted analogously to (43):

- (43) Which report that *John* revised is the one that *he* submitted?

The mechanism by which this interpretation might come about is unclear, however.

9. Conclusion

The reference tracking procedure proposed in this paper has the following properties.

Indices are assigned as soon as an element is merged to the structure. A binding relation between α and δ is established as soon as α is merged to β containing δ . The elements that can be so bound are *variable referential elements*: pronouns and anaphors. The referential properties of these elements are indicated by a combination of inner and outer indices, the latter to be determined by the antecedent (or also, in the case of pronouns, through other means not discussed here).

Principle C of the binding theory follows from the default indexing procedure, which requires that every newly merged element takes a different index. More precisely, the outer index of every newly merged noun phrase c-commanding an R-expression is biased to be complementary to the index of the R-expression. As a result, movement of the R-expression cannot lift obviation. Obviation can only be lifted if the interpretation of the element c-commanding the noun phrase is derived from another noun phrase c-commanded by the R-expression, as in the parallel construction *I gave him everything John wanted me to (give him)*.

Anaphors differ from pronouns in the familiar different locality conditions on binding. In addition, pronouns have the inherent property of allowing reference to be fixed through other means than binding (a type of index assignment we refer to as *absolute*). Once the difference between relative and absolute index assignment is recognized, the possibility of having sloppy and strict interpretations of pronouns under ellipsis follows automatically, assuming the bottom up reference tracking procedure discussed in this paper (in combination with a PF-deletion analysis of ellipsis).

Other constructions where principle C is lifted as a consequence of movement (as in *Which paper that John revised did he submit?*) remain problematic under the reference tracking approach discussed here.

References

- Aronoff, Mark. 1992. *Morphology By Itself*. Cambridge: MIT Press.
- Barss, Andrew. 1986. *Chains and Anaphoric Dependencies. On Reconstruction and its Implications*. Dissertation, MIT.
- Bouton, L. 1970. Antecedent-contained Pro-forms. *CLS* 6, 154-167.
- Chomsky, Noam. 1981. *Lectures on Government and Binding*. Dordrecht: Foris.
- Chomsky, Noam. 1982. *Some Concepts and Consequences of the Theory of Government and Binding*. Cambridge: MIT Press.
- Chomsky, Noam. 1986. *Knowledge of Language: Its Nature, Origin, and Use*. New York: Praeger.
- Chomsky, Noam. 1995. *The Minimalist Program*. Cambridge: MIT Press.
- Chomsky, Noam and Howard Lasnik. 1995. 'The Theory of Principles and Parameters'. In N. Chomsky, *The Minimalist Program*, 13-127.
- Epstein, Samuel D. 1995. 'Un-Principled Syntax and the Derivation of Syntactic Relations.' Ms., Harvard University.
- Fiengo, Robert and Robert May. 1994. *Indices and Identity*. Cambridge: MIT Press.
- Fox, Danny. 1995. 'Condition C Effects in ACD.' *MIT Working Papers in Linguistics* 27, 105-119.
- Halle, Morris and Alec Marantz. 1993. 'Distributed Morphology and the Pieces of Inflection.' In K. Hale and S.J. Keyser, eds., *The View from Building 20. Essays in Linguistics in Honor of Sylvain Bromberger*. Cambridge: MIT Press.
- Heim, Irene. 1992. 'Anaphora and Semantic Interpretation: A Reinterpretation of Reinhart's Approach.' Ms., MIT.
- Koster, Jan. 1985. 'Reflexives in Dutch.' In J. Guéron, H.-G. Obenauer, and J.-Y. Pollock, eds., *Grammatical Representation*. Dordrecht: Foris.
- Lasnik, Howard. 1985. 'Illicit NP-Movement: Locality Conditions on Chains?' *Linguistic Inquiry* 16, 481-490.
- Lasnik, Howard. 1989. *Essays on Anaphora*. Dordrecht: Kluwer.
- Lasnik, Howard. 1998. *Some Reconstruction Riddles*. Ms., University of Connecticut, Storrs.
- Lasnik, Howard and Mamoru Saito. 1992. *Move α . Conditions on Its Application and Output*. Cambridge: MIT Press.
- Lebeaux, D. 1990. Relative Clauses, Licensing, and the Nature of the Derivation. *Proceedings of NELS 20*, 318-332.
- Postal, Paul. 1971. *Cross-Over Phenomena*. New York: Holt, Rinehart, and Winston.
- Schürcks, Lily. 1998. *Minimalist Binding and Bulgarian*. Dissertation, University of Groningen.
- Tancredi, Christopher. 1992. *Deletion, Deaccenting, and Presupposition*. Dissertation, MIT.

- Ura, Hiroyuki. 1994. 'Varieties of Raising and the Feature-Based Phrase Structure Theory.' *MIT Occasional Papers in Linguistics* 7.
- Vanden Wyngaerd, Guido and Jan-Wouter Zwart. 1998. 'Merging Antecedent Contained Deletion.' Ms., University of Brussels and NWO/University of Groningen.
- Wasow, Thomas. 1972. *Anaphoric Relations in English*. Dissertation, MIT.
- Williams, Edwin S. 1977. 'Discourse and Logical Form.' *Linguistic Inquiry* 8, 101-139.
- Zwart, Jan-Wouter. 1997a. 'Binding without Indices: Consequences for Raising and Control'. Ms., University of Groningen.
- Zwart, Jan-Wouter. 1997b. *Morphosyntax of Verb Movement: A Minimalist Approach to the Syntax of Dutch*. Dordrecht: Kluwer.
- Zwart, Jan-Wouter. 1997c. 'Transitive Expletive Constructions and the Evidence Supporting the Multiple Specifier Hypothesis.' In: W. Abraham and E. van Gelderen, eds., *German: Syntactic Problems—Problematic Syntax*. Tübingen: Niemeyer.

Notes

1. The idea of describing binding as a function of Merge was brought to my attention by Lily Schürcks (see Schürcks 1998).
2. α c-commands β iff β is dominated by the minimal projection dominating α , and $\alpha = \beta$.
3. The classical definition of binding apparently aims to establish a subset of coreference relations, namely the set of coreference relations involving c-command. Binding can then be further divided into *anaphor binding* (which is local w.r.t. domain D and involves anaphors, reciprocals and reflexives) and *bound variable binding* (which is nonlocal w.r.t. domain D and involves pronominals—often called 'anaphora' in the semantic literature).
4. Chomsky's (1995:193, 205) approach to examples like (7), showing that the binding principles apply prior to LF, involves a) adoption of a *copy* theory of movement (the trace being a copy of the moved category) and b) an LF-operation which selectively deletes different parts of the two copies (i.e. the moved category and its trace). In (7), for example, the approach yields that we cannot exclude that *John* is still present in the position of the trace at LF, voiding the argument.
5. A familiar problem regarding the status of noun phrases as anaphors or pronominals is that not all languages make a morphological distinction between the two (e.g. Frisian, Old English). If these elements are defined as [+anaphoric, +pronominal] in C_{HL} , the LF interpretation principles would not know how to interpret them. This problem disappears if 'words' in C_{HL} are just bundles of syntactic and semantic features, which acquire their phonological features only in the morphological component at PF (Aronoff 1992, Halle & Marantz 1993,

Zwart 1997b). The LF interpretation procedure is only sensitive to the bundles of syntactic and semantic features, which differ in the cases of anaphors and pronouns, even if these two bundles of features receive the same spell out in certain languages, by morphological accident.

6. Another basic condition may be that merge involves two and only two terms (ensuring binary branching and precluding vacuous structure)
7. I intend 'reference' to be understood as the representation of an individual concept, not as reference to a real world entity.
8. In the notation of Tancredi (1992), apparently following Heim (1992), the dependent element in a binding relation bears only an inner index, whereas the antecedent bears an inner index and an outer index. In the notation employed here, only dependent elements bear an inner index and an outer index.
9. The question of whether anaphors are bound by the first noun phrase up or by any noun phrase within the local domain D hinges on the status of examples like (i):

- (i) a. ? Jan hoorde ons zichzelf een oplichter noemen
 John heard us himself a crook call
 b. Jan raadde ons zichzelf aan
 John suggested us himself PRT

In (ib), binding of *zichzelf* by *Jan* is unproblematic, but examples of this type may be irrelevant, when the indirect object is in fact a PP. In (ia), binding of *zichzelf* by *Jan* is curiously degraded (but significantly better than alternatives with *him*, *zich*, or *'mzelf*). There may be confusion with constructions like (ii), where the infinitive is passive and *zichzelf* is the derived subject of the infinitival clause:

- (ii) Jan hoorde zichzelf een oplichter noemen
 John heard himself a crook call

The contrast between (ia) and (ii) suggests that there is a 'minimality' factor in addition to the locality factor.

10. Various proposals have been made to allow extension of the local domain relevant to anaphor binding beyond the maximal projection of a tensed embedded clause, in view of examples like (i):

- (i) *John* saw that [[pictures of *himself*] were on sale]

I follow Koster (1985:142) in assuming that *himself* is not a genuine anaphor here, since the Dutch translation of (i) does not employ the genuine anaphor *zichzelf*, but the 'logophoric' element *'mzelf*.

11. Similar considerations apply if locality is not determined by an opacity factor but by an element of 'completion', as in the approach based on a complete functional complex (Chomsky 1986), or a complete licensing domain (Zwart 1997a).

12. Fiengo & May's (1994) analysis describes (24) as an exception to the rule that Principle C applies at S-structure (that rule is needed to explain that QR does not obviate Principle C in examples like (i) **I bought him_i everything John_i likes*). (24) then follows because QR takes the R-expression out of the scope of its binder. Fox's (1995) analysis modifies Fiengo & May's (1994) analysis, proposing that material from the copy left behind by QR is deleted when deletion is forced by interpretability requirements (for example to overcome the infinite regress in antecedent contained deletion contexts like (24), but crucially not in other constructions involving QR, like (i)).
13. Even an empty VP with a full fledged structure, as Williams (1977) assumes following Wasow (1972).
14. The traditional terminology, of course, is hopelessly confused. Constructions like (24) are indicated as 'antecedent contained deletion', while being analyzed in terms of reconstruction rather than deletion. 'Gap containing reconstruction' would be a term that describes the current standard analysis more appropriately and makes the concomitant 'infinite regress' more understandable.
15. Of course if the LF interpretation procedure were to operate in a bottom-up fashion, after reconstruction, the interpretation procedure would merely mirror the derivational procedure, and the question would be justified if it could not be dispensed with.
16. Chomsky (1986:197f) argues that (29) is ungrammatical because the chain (*John_it*) is Case-marked twice (violating the Chain Condition). Lasnik and Saito (1992:139) provide the example in (i) as making the same point as (29) without violating the Chain Condition:

(i) * John_i seems that [_D his_i belief t_i to be rich] is wrong

17. As with binding, it is not always clear that A-movement obeys the strictest version of locality referred to in the text (cf. note 9). Thus, examples like (i) may involve nonlocal A-movement across the direct object:

(i) [Het boek]_i werd Jan t_i overhandigd
 the book was John handed-over
 'The book was handed over to John.'

Ura (1994) presents a host of cases where A-movement takes place across the opacity factors 'tense' and 'subject'. As far as I have been able to assess, these cases do not unambiguously support the analysis proposed by Ura (cf. Zwart 1997c).

18. It is not clear to me how the idea that NP-traces are anaphors carries over in the present framework. If anaphors are defined as [+referential, +variable] elements that must have their reference fixed locally, the only point of similarity appears to be the locality factor. NP-trace, if regarded as a copy of the moved category (cf. Chomsky 1995:210), must be [+referential, -variable] and presumably does not need to have its reference fixed. The question is obscured by the circumstance

that traces are really subparts of discontinuous categories (chains). One possibility would be to interpret the tail of a chain as a [-referential,+variable] element, i.e. as a zero variant of anaphors and pronouns, which then, by analogy with anaphors and pronouns, could divide naturally into locally identified traces (A-traces) and nonlocally identified traces (A'-traces). This would entail that A'-traces are not R-expressions but pronouns (for the principles of the Binding Theory).

19. The elliptical construction in (i) does seem to allow a strict interpretation, where Bill loves John. However, it is a known fact that ellipsis applies to cases where strict morphological identity of the noun phrases involved is not observed (Bouton 1970, this fact is captured in reconstruction based approaches by a mechanism of *vehicle change*, cf. Fiengo and May 1994:218, VandenWyngaerd and Zwart 1991). Thus (i) may, and in the strict reading must, be derived from (ii) rather than from (iii).

- (i) John loves himself and Bill does, too.
- (ii) John loves himself and Bill does <love him> too.
- (iii) John loves himself and Bill does <love himself> too.

Note that reciprocals do not allow a strict reading (iv), presumably because the more complex semantics of reciprocals does not allow for variation (i.e. replacement by an ordinary pronoun) in deaccenting and ellipsis contexts:

- (iv) John and Mary love each other, and so do Bill and Sue <love each other *them>

In (iv), *them* is not a suitable counterpart to *each other* because the situation of Bill and Sue loving John and Mary does not parallel the situation of John loving Mary and Mary loving John.

20. I presume that this is the same contrast in indexical type that Fiengo and May (1994:47) capture using α - and β -occurrences of indices.
21. Importantly, the two occurrences of the pronoun cannot have two *different* absolute outer indices, e.g. yielding the interpretation *John thinks he (Harry) is a genius and so does Bill think he (Peter) is a genius*.
22. It follows that c-command is a precondition for sloppy interpretation of a deaccented or elliptical pronoun, a well-known fact.
23. The discussion in Lasnik (1998) suggests that the contrast in (40) is artificial, and that both sentences may be judged felicitous under the right circumstances. This only aggravates the problem noted in the text.
24. Chomsky (1995:204), following the analysis in Lebeaux (1990), proposes that the relative clause in (41a) is merged 'countercyclically', i.e. after the pronoun has been merged to the structure. This would solve the problem, but not if the discussion in Lasnik (1998) referred to in note 23 is correct.