

Proceedings of the thirty-fourth  
**Western Conference  
On Linguistics**

*Volume seventeen*

**WECOL 2006**

Edited by  
Erin Bainbridge  
Brian Agbayani

**Department of Linguistics  
California State University, Fresno  
Fresno, California 93740-8001**

Copyright © 2007 by the  
Department of Linguistics  
California State University, Fresno

“New Arguments for Right Node  
Raising as PF Deletion” Copyright ©  
2007 by Duk-Ho An

“Decomposing Case Paradigms”  
Copyright © 2007 by Anna Asbury

“One size fits all: prefixes, particles,  
adpositions and cases as members of  
the category P” Copyright © 2007 by  
Anna Asbury, Berit Gehrke and  
Veronika Hegedüs

“Prosodically-conditioned Sibilant  
Voicing in Balkan Judeo-Spanish”  
Copyright © 2007 by Travis G.  
Bradley

“The Perfect and the Implication of  
Counterfactuality: the Case of Rukai”  
Copyright © 2007 by Cheng-Fu Chen

“Rethinking Mass” Copyright © 2007  
by Lindsey N. Chen

“Left-to-Right Incrementality and  
Scrambling in Korean/Japanese”  
Copyright © 2007 by Youngju Choi

“Gestural Alignment Constraints and  
Unstressed Vowel Devoicing in  
Andean Spanish” Copyright © 2007 by  
Ann Marie Delforge

“The Syntax of Telicity in Vietnamese”  
Copyright © 2007 by Shin Fukuda

“The State of Statives after Spell-Out”  
Copyright © 2003 by Naomi Harada

“Connected Exceptives and Non-  
monotonic Inference” Copyright ©  
2007 by Iván García-Álvarez

“Extraposition as PF Movement”  
Copyright © 2007 by Edward Göbbel

“More on DP-IP Parallelism: Turkic  
and Circassian Case” Copyright ©  
2007 by Pavel Grashchenkov

“An Entailment Account of Scope  
Parallelism” Copyright © 2007 by  
Seungwan Ha

“Extremely Local Optimization”  
Copyright © 2007 by Fabian Heck and  
Gereon Müller

“Verb Phrase Pronominalization in  
Danish: Deep or Surface Anaphora?”  
Copyright © 2007 by Michael J.  
Houser, Line Mikkelsen, and Maziar  
Toosarvandani

“Winners Take All: ‘Missing  
Paradigms’ in Jinghpo” Copyright ©  
2007 by Feng-fan Hsieh

“Direct Complement Clauses as Object  
Control Structures in Turkish”  
Copyright © 2007 by Atakan Ince

“Why-in-Situ: Three Overt Syntactic  
Positions in Thai” Copyright © 2007  
by Jirapat Jangjamras

“Russian Partitive Case and the  
Quantized/Cumulative Distinction”  
Copyright © 2007 by Susie Jones

“The Romans’ Destruction the City”  
Copyright © 2007 by Cem Keskin

“Similarity Avoidance in East Bengali  
Fixed-Segment Echo Reduplication”  
Copyright © 2007 by Sameer ud Dowl  
Khan

“Agreement in Icelandic: An Argument  
for Derivational Theory of Intervention

Effects” Copyright © 2007 by Ivona Kučerová

“Does the Causing Component of a Resultative have to Involve an Activity?” Copyright © 2007 by Chao Li

“Local and Non-local Blocking in Vowel Harmony” Copyright © 2007 by Shakuntala Mahanta

“Cyclic Linearization, Remnant Movement, and a Typology of OV(S) Constructions” Copyright © 2007 by Vita G. Markman

“‘Not-so-propositional’ Islands and Their Implications for Swiping” Copyright © 2007 by Chizuru Nakao and Masaya Yoshida

“Agreeing and Non-Agreeing C: Evidence for C-to-T Phi-Feature Transfer” Copyright © 2007 by Hamid Ouali

“Phonological Phrasing in Barcelona Spanish” Copyright © 2007 by Rajiv Rao

“Reflecting AGREE: Hindi-Urdu Reflexives” Copyright © 2007 by Richa

“Interpretable [person] in T and  $\phi$ -Incomplete Small *v* for Spanish” Copyright © 2007 by Miguel Rodríguez-Mondoñedo

“The Scalar Sensitivity of the Japanese Scalar Additive Particles” Copyright © 2007 by Osamu Sawada

“Epistemic Restrictions on Free Choice *Herhangi bir* in Turkish” Copyright © 2007 by Nilüfer Gültekin Şener

“Cyclic NCI Movement” Copyright © 2007 by Serkan Şener

“Derivation of Two V° Coordination and its Theoretical Implications” Copyright © 2007 by Masaaki Takashima

“Nonreferential Reflexive NPs and a Requirement on One or More Occurrences of an Expression Type” Copyright © 2007 by Erika Trosseth

“The Acquisition of the Russian *Or*” Copyright © 2007 by Anna Verbuk

“Verb Movement and the Morphosyntax of Negation in Saami” Copyright © 2007 by Mikael Vinka

“Unifying Selective Islands Under *v*” Copyright © 2007 by Christopher A. Warnasch

“Building Resultatives in Icelandic” Copyright © 2007 by Matthew Whelpton

“On the Interpretation and Licensing of *Shika*-NPIs in Tokyo Japanese and the Syntax-Prosody Interface” Copyright © 2007 by Hideaki Yamashita

“The Semantics of Focus Particle *-shika* ‘only’ in Japanese” Copyright © 2007 by Keiko Yoshimura

ISBN 1-879890-17-8

## Contents

New Arguments for Right Node Raising as PF Deletion .....	9
<i>Duk-Ho An</i>	
Decomposing Case Paradigms.....	22
<i>Anna Asbury</i>	
One size fits all: prefixes, particles, adpositions and cases as members of the category P.....	34
<i>Anna Asbury, Berit Gehrke and Veronika Hegedűs</i>	
Prosodically-conditioned Sibilant Voicing in Balkan Judeo-Spanish .....	48
<i>Travis G. Bradley</i>	
The Perfect and the Implication of Counterfactuality: the Case of Rukai .....	61
<i>Cheng-Fu Chen</i>	
Rethinking Mass .....	74
<i>Lindsey N. Chen</i>	
Left-to-Right Incrementality and Scrambling in Korean/Japanese .....	83
<i>Youngju Choi</i>	
Gestural Alignment Constraints and Unstressed Vowel Devoicing in Andean Spanish.....	95
<i>Ann Marie Delforge</i>	
The Syntax of Telicity in Vietnamese .....	109
<i>Shin Fukuda</i>	
Connected Exceptives and Non-monotonic Inference .....	121
<i>Iván García-Álvarez</i>	

Extraposition as PF Movement .....	132
<i>Edward Göbbel</i>	
More on DP-IP Parallelism: Turkic and Circassian Case.....	146
<i>Pavel Grashchenkov</i>	
An Entailment Account of Scope Parallelism .....	158
<i>Seungwan Ha</i>	
Extremely Local Optimization .....	170
<i>Fabian Heck and Gereon Müller</i>	
Verb Phrase Pronominalization in Danish: Deep or Surface Anaphora?.....	183
<i>Michael J. Houser, Line Mikkelsen, and Maziar Toosarvandani</i>	
Winners Take All: “Missing Paradigms” in Jinghpo.....	196
<i>Feng-fan Hsieh</i>	
Direct Complement Clauses as Object Control Structures in Turkish.....	208
<i>Atakan Ince</i>	
Why-in-Situ: Three Overt Syntactic Positions in Thai.....	222
<i>Jirapat Jangjamras</i>	
Russian Partitive Case and the Quantized/Cumulative Distinction.....	235
<i>Susie Jones</i>	
The Romans’ Destruction the City.....	247
<i>Cem Keskin</i>	
Similarity Avoidance in East Bengali Fixed-Segment Echo Reduplication.....	257
<i>Sameer ud Dowla Khan</i>	

Agreement in Icelandic: An Argument for Derivational Theory of Intervention Effects.....	272
<i>Ivona Kučerová</i>	
Does the Causing Component of a Resultative Have to Involve an Activity?.....	285
<i>Chao Li</i>	
Local and Non-local Blocking in Vowel Harmony.....	296
<i>Shakuntala Mahanta</i>	
Cyclic Linearization, Remnant Movement, and a Typology of OV(S) Constructions.....	308
<i>Vita G. Markman</i>	
“Not-so-propositional” Islands and Their Implications for Swiping.....	322
<i>Chizuru Nakao and Masaya Yoshida</i>	
Agreeing and Non-Agreeing C: Evidence for C-to-T Phi-Feature Transfer.....	334
<i>Hamid Ouali</i>	

Phonological Phrasing in Barcelona Spanish.....	345
<i>Rajiv Rao</i>	
Reflecting AGREE: Hindi-Urdu Reflexives.....	361
<i>Richa</i>	
Interpretable [person] in T and $\phi$ -Incomplete Small v for Spanish.....	373
<i>Miguel Rodríguez-Mondoñedo</i>	
The Scalar Sensitivity of the Japanese Scalar Additive Particles.....	383
<i>Osamu Sawada</i>	
Epistemic Restrictions on Free Choice <i>Herhangi bir</i> in Turkish.....	398
<i>Nilüfer Gültekin Şener</i>	
Cyclic NCI Movement.....	407
<i>Serkan Şener</i>	
Derivation of Two V° Coordination and its Theoretical Implications.....	418
<i>Masaaki Takashima</i>	
Nonreferential Reflexive NPs and a Requirement on One or More Occurrences of an Expression Type.....	432
<i>Erika Troseth</i>	
The Acquisition of the Russian <i>Or</i> .....	443
<i>Anna Verbuk</i>	
Verb Movement and the Morphosyntax of Negation in Saami.....	456
<i>Mikael Vinka</i>	

Unifying Selective Islands Under <i>v</i> .....	466
<i>Christopher A. Warnasch</i>	
Building Resultatives in Icelandic.....	478
<i>Matthew Whelpton</i>	
On the Interpretation and Licensing of <i>Shika</i> -NPIs in Tokyo Japanese and the Syntax-Prosody Interface.....	487
<i>Hideaki Yamashita</i>	
The Semantics of Focus Particle <i>-shika</i> ‘only’ in Japanese.....	499
<i>Keiko Yoshimura</i>	



# New Arguments for Right Node Raising as PF Deletion

Duk-Ho An

University of Connecticut

## 1. Multi-Dominance and Deletion Approaches to RNR

In recent literature on Right Node Raising (RNR), two approaches have been particularly influential: multi-dominance and deletion (see McCawley 1982, Erteschik-Shir 1987, Moltmann 1992, Wilder 1999, 2001, Abels 2003, Chung 2004, Park 2005, de Vos and Vincente 2005 for the former; see Wexler and Culicover 1980, Booij 1985, van Oirsouw 1987, Swingle 1993, Kayne 1994, Wilder 1994, 1997, Schein 1997, Hartmann 2000, Mukai 2003, Bošković 2004, te Velde 2005, Ha 2006 for the latter). Under these analyses, an RNR sentence like (1) can be analyzed as in (2) and (3), respectively. (Throughout, RNR elements are italicized.)

(1) Mary suspected and John believed *that Tom was a secret agent*

(2) Multi-Dominance

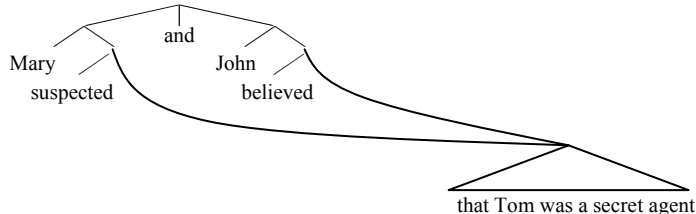

(3) Deletion

[Mary suspected ~~that Tom was a secret agent~~] and  
[John believed that Tom was a secret agent]

The difference between the two approaches is clear: under the multi-dominance analysis, the shared items, which I will henceforth call *the target*, are literally shared via multi-dominance; under the deletion analysis, all the conjunct clauses underlyingly involve a full clause, which is subsequently reduced by deletion.

Hence, the basic difference between these approaches is that under the former, there is a single instance of the target, while there are multiple instances of the target under the latter.

In this paper, I will examine these approaches based on a set of novel data. I will argue that the data examined here provide support for the deletion analysis. In so doing, I will also point out that the multi-dominance analysis faces the problem of over- and undergeneration.

## 2. Multiple Traces

The data in (4) and (5) illustrate scrambling in RNR sentences in Korean and Japanese. The point to note here is that the object of the embedded clause, indicated by bold letters, is extracted out of each conjunct in a parallel way prior to the application of RNR. As a result, the embedded clause is RNRed along with the trace of the scrambled object.

- (4) **ppang-ul** Tomo-ka, kuliko **bap-ul** Nina-ka, (K)  
 bread-acc T-nom and rice-acc N-nom  
*Ana-ka t mekess-tako malhayssta*  
 A-nom ate-comp said  
 ‘Bread, Tomo (said that Ana ate t) and rice, Nina said that Ana ate t.’
- (5) **pan-o** Tomo-ga, sosite **gohan-o** Nina-ga, (J)  
 bread-acc T-nom and rice-acc N-nom  
*Ana-ga t tabeta-to itta*  
 A-nom ate-comp said  
 ‘Bread, Tomo (said that Ana ate t) and rice, Nina said that Ana ate t.’

Given this, notice that if we assume that there is only one occurrence of the target in the structure, as should be the case under the multi-dominance analysis, it would be unclear how the distinct objects could be extracted out of the unique source. In other words, the problem is that there are not enough base-positions for the extracted objects under the multi-dominance analysis.

The above argument is based on the implicit assumption that multi-dominance applies to constituents: in the case at hand, the relevant constituent would be the category that contains the embedded CP and the matrix verb – something like matrix VP. However, given the fact that RNR may affect non-constituents, as suggested by (6) and (7), we seem to need to allow multiple applications of multi-dominance.

- (6) Tomo-nun Ana-ka ppang-ul, kuliko Nina-nun Ana-ka bap-ul, (K)  
 T-top A-nom bread-acc and N-top A-nom rice-acc  
*mekess-tako kun sori-lo malhayssta*  
 ate-comp big.voice-with said  
 ‘Tomo (said with loud voice that) Ana (ate) bread and Nina said with loud voice that Ana ate rice.’
- (7) Tomo-wa Ana-ga pan-o, sosite Nina-wa Ana-ga gohan-o (J)  
 T-top A-nom bread-acc and N-top A-nom rice-acc  
*tabeta-to oo goe-de itta*  
 ate-comp big.voice-with said  
 ‘Tomo (said with loud voice that) Ana (ate) bread and Nina said with loud voice that Ana ate rice.’

Once we allow multiple multi-dominance, the number of possible multi-dominance configurations for an RNR target increases rapidly. For instance, in (4) and (5), in addition to the possibility of multi-dominating the matrix VP containing both the embedded clause and the matrix verb, it is possible that the embedded CP is multi-dominated separately from the matrix verb, which is also multi-dominated, as in (8).<sup>1</sup>

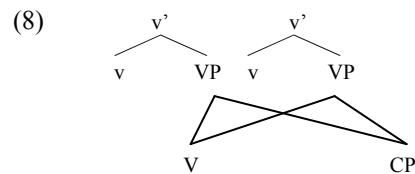

Alternatively, it may be that all the words in the target are individually multi-dominated. Under this view, it becomes possible to provide separate base-positions for the extracted objects in (4) and (5), which then weakens the above argument. I present in (9) the relevant portion of the structure of (4) and (5) under this view. (I use English words for convenience.)

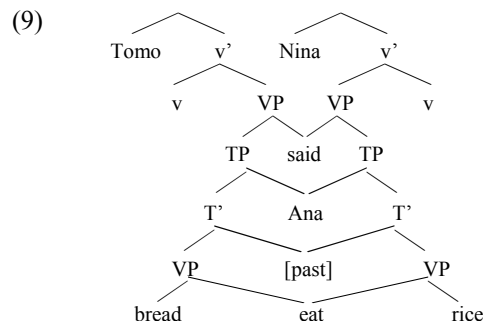

While (9) seems to provide a technical solution to the problem raised above, it also brings in a different type of problem – that is, the problem of overgeneration. For instance, if we allow structures like (9), it is difficult to see why sentences like (10), whose derivation is illustrated in (11), are disallowed.

- (10) \* sakwa-rul Ana-nun ppang-ul mekessta (K)  
 apple-acc A-top bread-acc ate  
 ‘Apple, Ana ate bread.’

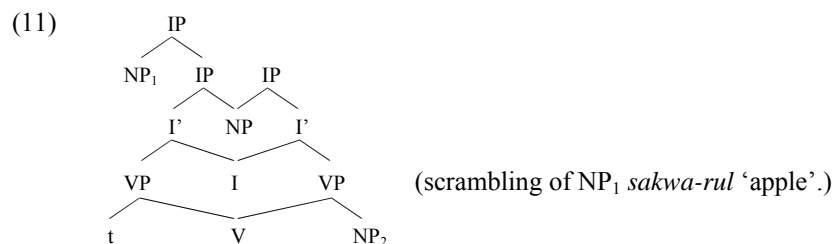

On the other hand, sentences like (4) and (5) are readily accounted for under the deletion analysis, if we assume that the relevant deletion operation applies in PF – crucially, after scrambling of the relevant objects. Under the usual assumption that traces/copies are eliminated in PF, nothing would prevent deletion from applying under identity in the case at hand. The derivation of (4) under the deletion analysis is illustrated in (12).

- (12) ppang<sub>i</sub>-ul Tomo-ka Ana-ka ~~t<sub>i</sub>~~ mekess-tako malhayssta kuliko  
 bread-acc T-nom A-nom ate-comp said and  
 bap<sub>j</sub>-ul Nina-ka Ana-ka t<sub>j</sub> mekess-tako malhayssta  
 rice-acc N-nom A-nom ate-comp said

In sum, while a technical solution seems to allow us to avoid a particular problem raised above for the multi-dominance analysis, the solution leads to

another type of problem, which may actually be more serious than the original problem. Either way, the phenomenon examined here provides an argument in favor of the deletion analysis of RNR.

### 3. Multiple Binders

Section 2 illustrated a problem for the multi-dominance analysis that arises due to a discrepancy between the number of elements extracted from inside the target and that of the target itself. I have shown that while a technical solution is made available by allowing multiple multi-dominance, this comes with the cost of overgeneration. In this section, I will examine a different type of dependency between target-external and target-internal elements. More specifically, I will show that a pronominal contained in an RNR target can be bound by distinct elements outside of the target, allowing a sloppy identity-like interpretation. This poses a more difficult problem for the multi-dominance analysis (than the one discussed in section 2) since in this case, the pronoun stays in situ, i.e., allowing multiple multi-dominance will not help.<sup>2</sup>

- (13) Jeff<sub>i</sub>-nun Nina-ekey, kuliko Tomo<sub>j</sub>-nun Lydia-ekey, (K)  
 J-top N-dat and T-top L-dat  
*ku<sub>ij</sub>-uy/caki<sub>ij</sub>-uy cha-rul pillye cwuessta*  
 he-gen/self-gen car-acc lent  
 ‘Jeff (lent his car) to Nina and Tomo lent his car to Lydia.’
- (14) Jeff<sub>i</sub>-wa Nina-ni, sosite Tomo<sub>j</sub>-wa Lydia-ni, (J)  
 J-top N-dat and T-top L-dat  
*kare<sub>ij</sub>-no/zibun<sub>ij</sub>-no kuruma-o kasita*  
 he-gen/self-gen car-acc lent  
 ‘Jeff (lent his car) to Nina and Tomo lent his car to Lydia.’

Here, the pronominal contained in the target can be bound by the subject of each conjunct simultaneously, i.e., it allows a sloppy identity-like interpretation. Regardless of the mode of multi-dominance employed here, i.e., whether the relevant pronominal is individually multi-dominated or is contained in a bigger constituent that is multi-dominated, it is certain that there can be only one instance of the pronominal. Given this, it is unclear how a single pronominal can be bound by distinct antecedents simultaneously. Thus, the data here pose a serious problem for the multi-dominance analysis.

On the other hand, the state of affairs is rather easily captured under the deletion analysis. I illustrate in (15) the relevant step of the derivation of (13).

- |      |          |            |                          |                            |        |
|------|----------|------------|--------------------------|----------------------------|--------|
| (15) | Jeff-nun | Nina-ekey  | <del>ku-uy cha-rul</del> | <del>pillie cwuessta</del> | kuliko |
|      | J-top    | N-dat      | he-gen car-acc           | lent                       | and    |
|      | Tomo-nun | Lydia-ekey | <i>ku-uy cha-rul</i>     | <i>pillie cwuessta</i>     |        |
|      | T-top    | L-dat      | he-gen car-acc           | lent                       |        |

Given this, I conclude that the data examined in this section provide a further argument in favor of the deletion analysis.

#### 4. Control

In this section, I will examine cases where a PRO subject contained in an RNRed nonfinite clause is controlled by the matrix subject of each conjunct at the same time, yielding a kind of sloppy identity interpretation. As shown in section 3, the availability of such an interpretation poses a problem for the multi-dominance analysis. Consider (16) and (17).

- |      |   |               |                        |                        |             |     |
|------|---|---------------|------------------------|------------------------|-------------|-----|
| (16) | Nina <sub>i</sub> -nun  | Jean-ekey,    | kuliko                 | Tomo <sub>j</sub> -nun | Lydia-ekey, | (K) |
|      | N-top   | J-dat         | and                    | T-top                  | L-dat       |     |
|      | <i>PRO<sub>ij</sub></i>   | <i>ilchik</i> | <i>tolaokayss-tako</i> | <i>yaksokhayssta</i>   |             |     |
|      |   | early         | return-comp            | promised               |             |     |
|      | ‘Nina (promised) Jean (to come back early) and Tomo promised Lydia to come back early.’ |               |                        |                        |             |     |
- 
- |      |   |               |                 |                       |           |     |
|------|---|---------------|-----------------|-----------------------|-----------|-----|
| (17) | Nina <sub>i</sub> -wa   | Jean-ni,      | sosite          | Tomo <sub>j</sub> -wa | Lydia-ni, | (J) |
|      | N-top   | J-dat         | and             | T-top                 | L-dat     |     |
|      | <i>PRO<sub>ij</sub></i>   | <i>hayaku</i> | <i>kaeru-to</i> | <i>yakusokusi-ta</i>  |           |     |
|      |   | early         | return-comp     | promised              |           |     |
|      | ‘Nina (promised) Jean (to come back early) and Tomo promised Lydia to come back early.’ |               |                 |                       |           |     |

Here, the target contains a PRO subject. As the indices indicate, this PRO is controlled by the matrix subject of each conjunct at the same time, yielding a kind of sloppy identity interpretation. As in the case of pronominals, discussed in section 3, this is problematic for the multi-dominance analysis, since under this analysis there should be only one instance of the PRO in question. Therefore, it is not clear how this PRO can be controlled by two distinct elements at the same time.<sup>3</sup>

On the other hand, the data receive a straightforward account under the deletion analysis. (18) illustrates the relevant step of the derivation of (16).

- (18) [Nina<sub>i</sub>-nun Jean-ekey [~~PRO<sub>i</sub>-ilchik tolaokayss-tako~~]  
 N-top J-dat early return-comp  
~~yaksokhayssta~~] kuliko [Tomo<sub>j</sub>-nun Lydia-ekey  
 promised and T-top L-dat  
 [~~PRO<sub>j</sub> ilchik tolaokayss-tako~~] yaksokhayssta]]  
 early return-comp promised

Note incidentally that if we assume that control involves overt movement, as Hornstein (1999, 2001) argues, the data examined here can be considered to pose the same kind of problem as that raised in section 2. Either way, the data examined in this section pose a problem for the multi-dominance analysis.

## 5. Honorification

The discussion so far has relied on the difference between the two approaches in question with respect to the relation between the target and the rest of the sentence, which I will henceforth call *remnants*. For instance, under the multi-dominance analysis, there is only one instance of the target in the structure, while there can be (underlyingly) many instances of the target under the deletion analysis. In this section, I will examine another aspect of the structural relation between the target and the remnants under the two approaches in question and show that they make different predictions. Note that under the multi-dominance analysis, all the remnants establish the same structural relation with the target, since they literally share the target, while under the deletion analysis, what appears to be shared is in fact part of the second conjunct only. Hence, under the former analysis, the target-remnant relation across conjuncts is symmetric, while under the latter, it is asymmetric.

Assuming this, I will examine below honorification marking in Korean and Japanese and show that conjuncts in RNR sentences show an asymmetric behavior with respect to the target, consistent with the predictions made by the deletion analysis. The relevant honorification phenomenon we will be concerned with involves subject honorification, an optional marking of politeness on the predicate when the subject of the sentence is socially superior or respectable to the participants in conversation, as in (19).

- (19) kyoswunim-un chayk-ul sa-si-ess-ta (K)  
 professor-top book-acc buy-hon-past-dec  
 ‘The professor bought a book.’

While there is some controversy with respect to the real nature of honorification marking (Choe 2004, Harada 1976, Namai 2000, Niinuma 2003, Ura 1996), it is sufficient for our purposes to note that this phenomenon is constrained by

certain syntactic factors. That is, it has to be the local subject that licenses the honorification marking, as suggested by (20) and (21).<sup>4</sup>

- (20) kyoswunim-uy kay-ka cicu-(\*si)-ess-ta (K)  
 professor-gen dog-nom bark-hon-past-dec  
 ‘The professor’s dog barked.’
- (21) kyoswunim-un [Ana-ka chayk-ul sa-(\*si)-ess-tako] (K)  
 professor-top A-nom book-acc buy-hon-past-comp  
 malhayssta  
 said  
 ‘The professor said that Ana bought a book.’

Given this background, let us consider the behavior of honorification marking in RNR sentences. Here, the predicate with honorification marking is contained in the target. The crucial point to note is that only one of the subjects – namely, the subject of the second conjunct – is able to license honorification.<sup>5</sup>

- (22) Tomo-nun bap-ul, kuliko **kyoswunim-un** ppang-ul, (K)  
 T-top rice-acc and professor-top bread-acc  
*Nina-ekey cwu-si-ess-ta*  
 N-dat give-hon-past-dec  
 ‘Tomo (gave) rice (to Nina) and the professor gave bread to Nina.’
- (23) \* **kyoswunim-un** ppang-ul, kuliko Tomo-nun bap-ul, (K)  
 professor-top bread-acc and T-top rice-acc  
*Nina-ekey cwu-si-ess-ta*  
 N-dat give-hon-past-dec
- (24) Tomo-wa Jeff-ni, sosite **sensei-wa** Nina-ni, (J)  
 T-top M-to and teacher-top N-dat  
*hon-o o-okurini natta*  
 book-acc hon-send past  
 ‘Tomo (sent a book) to Jeff and teacher sent a book to Nina.’
- (25) \* **sensei-wa** Nina-ni, sosite Tomo-wa Jeff-ni, (J)  
 teacher-top N-dat and teacher-top N-dat  
*hon-o o-okurini natta*  
 book-acc hon-send past

I take this to indicate that the conjuncts of an RNR sentence do not have the same structural relation to the target. In fact, only the second conjunct has a direct relation to the target, which is predicted by the deletion analysis, as shown in (26).<sup>6</sup>



- (26) Tomo-nun      bap-ul      ~~Nina-ekey~~      ~~ewu-ess-ta~~      kuliko  
 T-top            rice-acc    N-dat            give-past-dec    and  
 kyoswunim-un   ppang-ul   *Nina-ekey*    *cwu-si-ess-ta*  
 professor-top   bread-acc   N-dat            give-hon-past-dec

However, it is not clear how this asymmetry can be captured under the multi-dominance analysis, since under this analysis, all the conjuncts establish the same structural relation to the target. Therefore, the ungrammaticality of (23) and (25) requires additional assumptions under this analysis.

## 6. Linearization

One of the questions raised for the multi-dominance analysis is that of linearization. That is, given that a multi-dominated element belongs to all the conjuncts at the same time, it causes a contradiction of linear order, since for instance elements in the first conjunct must precede elements in the second, i.e., the multi-dominated element must precede itself. Given this, proponents of the multi-dominance analysis, e.g., Wilder (1999, 2001), propose a revision of Kayne's (1994) LCA, the consequence of which I will discuss in this section. The details of the modification of the LCA system are given below.

- (27) a.  $X$  *c-commands*  $Y$  by virtue of  $Y$  being contained in  $X$ 's sister.  
 b. A *dominance path* of  $\alpha$  is a sequence of categories  $\langle C_1, \dots, C_n \rangle$  such that  $C_1 =$  the root,  $C_n = \alpha$ , and for all  $j$  ( $1 \leq j \leq n$ )  $C_j$  immediately dominates  $C_{j+1}$ .  
 c.  $\alpha$  *fully dominates*  $\beta$  iff  $\alpha$  is a member of every dominance path of  $\beta$ .  
 d.  $\alpha$  is a *shared* constituent of  $X$  iff  $X$  dominates, but not fully dominates  $\alpha$ .  
 e. The *image* of a category  $X$ ,  $d(X)$ , is the (unordered) set of terminals fully dominated by  $X$ . (Wilder 1999)

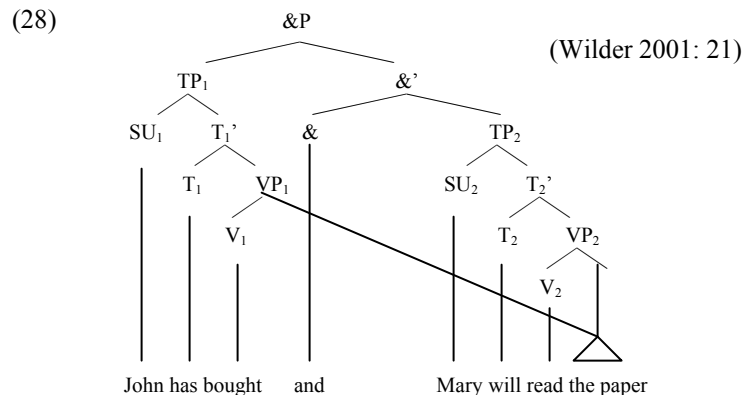

Under the set of assumptions in (27), the multi-dominance structure in (28) can be linearized as in (29).

- (29) a. Within TP<sub>1</sub>: John > has > bought > the > paper  
 b. Within &': and > Mary > will > read > the > paper  
 c. TP<sub>1</sub> asymmetrically c-commands elements in &'.  
 Hence, {John, has, bought} > {and, Mary, will, read, the, paper}.

The sum of (29a)-(29c) gives the correct order of the elements in (28): John > has > bought > and > Mary > will > read > the > paper.

Now, the problem that went unnoticed under this formulation is a situation where a proper subpart of a left-branch element is multi-dominated, as in (30). The relevant portion of the structure of (30) is given in (31).

- (30) (?) I think MARY's, but he thinks SUSAN's, *father is sick*

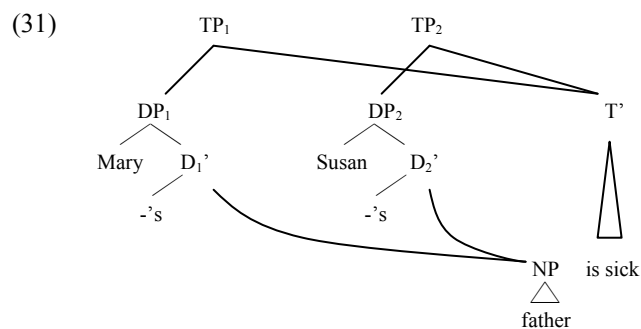

Note that in (31), the shared NP does not c-command out of the DPs that dominate it – crucially, it does not c-command T'. Being multi-dominated, the

NP is not contained in the image of DP<sub>1</sub> or DP<sub>2</sub> either. Hence, we do not have any way to determine the linear order of the elements in NP with respect to the elements contained in T', i.e., the structure is unlinearizable.<sup>7</sup>

In contrast, the deletion analysis accounts for (30) without any additional assumptions, as shown in (32).

(32) I think MARY's ~~father is sick~~ but he thinks SUSAN's *father is sick*

## 7. Conclusion

In this paper, I have compared the multi-dominance analysis and the deletion analysis of RNR based on a set of novel data and argued that the latter analysis fares better. However it should also be noted that in the literature, evidence has accumulated in the direction that favors the multi-dominance analysis as well (see the references cited at the outset). In this situation, one is faced with three logical possibilities to explore: (i) reduce everything to either multi-dominance or deletion and try to explain problematic cases in a better way; (ii) allow the two systems as legitimate alternatives in grammar; (iii) look for a third analysis that can handle everything. This is a question that goes beyond the boundary of this paper. See An (in preparation) for relevant discussion.

## Notes

<sup>1</sup> But note that for analyses like (8) and (9) to be tenable, it has to be the case that there is no overt V-raising to subsequent functional categories. See however Koizumi 2000 for arguments that verbs overtly raise to higher functional domain in Japanese. A technical solution would be to assume that all subsequent heads in (8) and (9) are also multi-dominated. However, this leads to a problem of overgeneration of the sort represented by (10).

<sup>2</sup> In (13) and (14), speakers have different preferences between a pronominal form and a reflexive form. But this does not affect the argument.

<sup>3</sup> One might suspect that given the word order, the PRO subject in (16) and (17) may be outside of the target. That is, one may suspect that what is shared in these sentences may be smaller than the embedded TP – presumably, something like vP, excluding the PRO subject. If this is correct, then the structure of (16) and (17) can be schematically represented as in (i). (For ease of exposition, I illustrate the derivation of these sentences in terms of the deletion analysis.)

(i) [<sub>TP</sub> Subj<sub>i</sub> [<sub>vP</sub> Dat [<sub>TP</sub> PRO<sub>i</sub> [<sub>vP</sub> ~~Adv Verb~~] Verb ]]] and  
 [<sub>TP</sub> Subj<sub>j</sub> [<sub>vP</sub> Dat [<sub>TP</sub> PRO<sub>j</sub> [<sub>vP</sub> Adv Verb]] Verb ]]

As the indices indicate, the fact that PRO is controlled by distinct subjects is not a problem here, because there are two distinct PROs. (Note incidentally that within the embedded clause in (i), a single T head (and v head as well) must license two SpecTPs, occupied by distinct PROs. Recall that such a configuration, which is unavoidable under the multi-dominance analysis to derive this kind of sentences, has an undesirable consequence of overgeneration, as discussed in section 2.)

However, such a complication can be avoided by burying deeper the nonfinite embedded clause into the target, as in (ii) and (iii). In this case, there is no possibility of putting the PRO subject

outside of the target. Hence the argument based on the sloppy identity-like control of PRO is still valid.

- (ii) Nina-nun cenhwa-ro, kuliko Tomo-nun imeyil-ro, (K)  
 N-top telephone-by and T-top email-by  
 [(PRO) *rwummeyit-ekey* [PRO *ilchik tolaokeyss-tako*] *yaksokhayssta*]  
 roommate-dat early return-comp promised  
 ‘Nina (promised (her) roommate to come back early) by phone and Tomo promised (his) roommate to come back early by email.’
- (iii) Nina-wa denwa-de, sosite Tomo-wa email-de, (J)  
 N-top telephone-by and T-top email-by  
 [(PRO) *roommate-ni* [PRO *hayaku kaeru-to*] *yakusokusi-ta*]  
 roommate-dat early return-comp promised  
 ‘Nina (promised (her) roommate to come back early) by phone and Tomo promised (his) roommate to come back early by email.’

<sup>4</sup> Subject honorification in Japanese works basically the same. But, for reasons of space, I will not provide data here.

<sup>5</sup> Van Oirsouw (1987: 234-235) notes a similar case of asymmetric agreement in RNR constructions. For instance, in Hopi and Palestinian Arabic, it is the linearly closest NP (to the verb) that controls agreement.

<sup>6</sup> In (26), the predicates are not completely identical in their morphological form. Note however that certain morphological (usually, inflectional) mismatches do not interfere with deletion (Lasnik 1995, Bošković 1996, 2004).

- (i) a. John will, and Peter was, *sleeping in her office*  
 b. John will, and Peter has, *slept in her house* (Bošković 1996: 7)

<sup>7</sup> It is even possible under this formulation that elements in T' precede NP, which is ungrammatical.

## References

- Abels, K. 2003. “Right Node Raising: Ellipsis or Across the Board Movement?”, *NELS* 34, K. Moulton & M. Wolf (eds), 45-59. GLSA, Amherst.
- An, D. in preparation. *Syntax at the PF interface*. Ph.D. dissertation. UConn, Storrs.
- Booij, G.E. 1985. “Coordination reduction in complex words: a Case for prosodic phonology”, *Advances in nonlinear phonology*, H. Hulst & N. Smith (eds), 143-160. Dordrecht: Foris.
- Bošković, Ž. 1996. “On right node base-generation”. Ms., UConn, Storrs.
- Bošković, Ž. 2004. “Two notes on right node raising”, *UConn Working Papers in Linguistics* 12, M.R. Mondonedo & M.E. Ticio (eds), 13-24. Department of Linguistics, UConn, Storrs.
- Choe, J. 2004. “Obligatory honorification and the honorific feature”, *Studies in Generative Grammar*, 14.:545-559.
- Chung, D. 2004. “Multiple dominance analysis of Right Node Raising”, *Language Research*, 40:791-812.
- Erteschik-Shir, N. 1987. “Right node raising”, *MITWPL*, 9:105-117.
- Ha, S. 2006. Multiple dominance CAN'T, but PF-deletion CAN account for Right Node Raising. Paper presented at the 42<sup>nd</sup> Annual Meeting of the CLS, April.
- Harada, S. I. 1976. “Honorifics”, *Syntax and semantics 5: Japanese generative grammar*, M. Shibatani (ed.), 499-561. New York: Academic Press.
- Hartmann, K. 2000. *Right Node Raising and Gapping: Interface conditions on prosodic deletion*. Amsterdam: John Benjamins.

- Hornstein, N. 1999. "Movement and control", *Linguistic Inquiry*, **30**:69-96.
- Hornstein, N. 2001. *Move! A minimalist theory of construal*. Oxford: Blackwell.
- Kayne, R. 1994. *The antisymmetry of syntax*. Cambridge, Mass.: MIT Press.
- Lasnik, H. 1995c. "Verbal morphology: Syntactic Structures meets the Minimalist Program", *Evolution and revolution in linguistic theory*, H. Campos & P. Kempchinsky (eds), 251-275. Washington, DC: Georgetown University Press.
- Koizumi, M. 2000. "String vacuous overt verb raising", *Journal of East Asian Linguistics*, **9**:277-285.
- McCawley, J.D. 1982. "Parentheticals and discontinuous constituent structure", *Linguistic Inquiry*, **13**:91-106.
- McCloskey, J. 1986. "Right node raising and preposition stranding", *Linguistic Inquiry*, **7**:183-186.
- Moltmann, F. 1992. *Coordination and comparatives*. Ph.D. dissertation. MIT.
- Mukai, E. 2003. "On verbless conjunction in Japanese", *NELS 33*, M. Kadowaki and S. Kawahara (eds), 205-224. Amherst, Mass.: GLSA.
- Namai, K. 2000. "Subject honorification in Japanese", *Linguistic Inquiry*, **31**:170-176.
- Niinuma, F. 2003. *The syntax of honorification*. Ph.D. dissertation. UConn, Storrs.
- van Oirsouw, R. R. 1987. *The syntax of coordination*. London: Croom Helm.
- Park, M. 2005. When things are coordinated or distributed across coordinate conjuncts. Paper presented at the 7<sup>th</sup> Seoul International Conference on Generative Grammar. Konkuk University, Seoul.
- Ross, J.R. 1967. *Constraints on variables in syntax*. Ph.D. dissertation. MIT.
- Schein, B. 1997. Conjunction reduction redux. Ms. USC.
- Swingle, K. 1993. "The role of prosody in Right Node Raising", *Syntax at Santa Cruz*, **2**:84-111.
- Ura, H. 1996. *Multiple feature checking: A theory of grammatical function splitting*. Ph.D. dissertation. MIT.
- te Velde, J.R. 2005. "Unifying prosody and syntax for right- and left-edge coordinate ellipsis", *Lingua*, **115**:483-502.
- de Vos, M. and L. Vincente. 2005. "Coordination under Right Node Raising", *WCCFL 24*, J. Alderete et al. (eds), 97-104. Somerville, Mass.: Cascadilla Proceedings Project.
- Wexler, K. and P. Culicover. 1980. *Formal principles of language acquisition*. Cambridge, Mass.: MIT Press.
- Wilder, C. 1994. "Coordination, ATB and Ellipsis", *Groninger Arbeiten zur Germanistischen Linguistik*, **37**:291-329.
- Wilder, C. 1997. "Some properties of ellipsis in coordination", *Studies on universal grammar and typological variation*, A. Alexiadou & T. Alan Hall (eds), 59-107. Amsterdam/Philadelphia: John Benjamins.
- Wilder, C. 1999. "Right node raising and the LCA", *WCCFL 18*, A. Carnie, S.F. Bird, J.D. Haugen, & P. Norquest (eds), 586-598. Cascadilla Press.
- Wilder, C. 2001. Shared constituent and linearization. Ms. ZAS, Berlin.

Duk-Ho An  
 University of Connecticut  
 Department of Linguistics  
 University of Connecticut  
 337 Mansfield Rd, U-1145  
 Storrs, CT 06269

# Decomposing Case Paradigms<sup>1</sup>

Anna Asbury

Utrecht Institute of Linguistics OTS, Utrecht University

## 1 Introduction

The hypothesis to be presented here is that case paradigms can be syntactically decomposed along similar lines to Déchaine and Wiltschko's (2002) decomposition of pronouns. Just as different pronouns spell out different syntactic items, so do different cases.

Déchaine and Wiltschko (2002) propose that pronouns spell out one of three different levels of syntactic structure: DP,  $\phi$ P, NP, as illustrated in (1).

- (1) Déchaine and Wiltschko's structures for pronouns (2002:410)
- a. pro-DP: Halkomelen independent pronouns  
 $[_{DP} [ D [_{\phi P} [ \phi [_{NP} [ N]]]]]]]$
  - b. pro- $\phi$ P: Shuswarp independent pronouns  
 $[_{\phi P} [ \phi [_{NP} [ N]]]]]$
  - c. pro-NP: Japanese *kare*  
 $[_{NP} [ N]]]$

Grimshaw (2000) argues that adpositions (P) are in the extended projection of the noun. Research on adpositions shows that case affixes with spatial meanings (e.g. Finnish adessive *-lla/-llä* 'on', allative *-lle* 'onto') spell out P (cf. Fillmore (1968), Emonds (1985), Nikanne (1991), Beard (1995), van Riemsdijk and Huybregts (2001)). Such cases appear as a suffix as a result of head movement of the noun.

Bittner and Hale (1996) argue that ergative, accusative and many other cases involve a KP projection above the noun. Nominative case, by contrast, has no KP, and nominative nouns are argued to be caseless.

This paper proposes an extension of Déchaine and Wiltschko's (2002) approach to account for case paradigms. Different morphological cases can be analysed as spelling out different levels of nominal functional structure. Where previous researchers have argued for this with respect to the category P (Fillmore 1968, among others), and nominative is already viewed as absence of case (Bittner and Hale 1996), the original part of this proposal will show that in Finnish there is evidence for relating partitive case to a Q(uantifier) head, genitive to a D(eterminer) head, and accusative to a  $\phi$  (person/number) head. Thus the proposal results in a complete break-down of cases as illustrated in (2). This is applied to the Finnish case system, illustrated in (3).



## 2.1 The problem with partitive case

Partitive alternates with nominative on subjects (4-5) and accusative<sup>3</sup> on objects (6-7) where the interpretation involves indefinite quantity or negation (Karlsson 1999).

- |     |   |   |
|-----|---|---|
| (4) | Partitive, limited quantity<br>Purki-ssa on <b>leipä-ä</b> .<br>tin-INESS is <b>bread-PART</b><br>'There is some bread in the tin.'           | cf. Nominative, definite<br><b>Leipä</b> on purki-ssa.<br><b>Bread</b> is tin-INESS<br>'The bread is in the tin.'                 |
| (5) | Partitive, negation of existence<br>Kadulla ei ole <b>auto-a</b> .<br>street not is <b>car-PART</b><br>'There aren't any cars in the street.' | cf. Nominative, incomplete negation<br><b>Auto</b> ei ole kadulla.<br><b>car</b> not is street<br>'The car is not in the street.' |
| (6) | Partitive, non-limited quantity<br>Silja joi <b>maito-a</b> .<br>Silja drank <b>milk-PART</b><br>'Silja drank some milk.'                     | cf. Accusative, limited quantity<br>Silja joi <b>maito-n</b> .<br>Silja drank <b>milk-ACC</b><br>'Silja drank the milk.'          |
| (7) | Partitive object with negation<br>En osta <b>auto-a</b> .<br>not buy <b>car-PART</b><br>'I won't buy the car.'                                | cf. Accusative in positive sentence<br>Osta-n <b>auto-n</b> .<br>buy-1SG <b>car-ACC</b><br>'I buy/will buy the car.'              |

This alternation contrasts with the behaviour of inherent cases, where selection is determined by the verb (8).

- |     |  |   |
|-----|--|---|
| (8) | Sointu <b>kehoitti</b><br>Sointu <b>encouraged</b><br>'Sointu encouraged Toini to sing.' | Toinia laula-ma-an.<br>Toini sing-INF-ILL<br>(from Fong 2001:2) |
|-----|--|---|

It is therefore problematic to account for the partitive as either inherent or structural. An inherent case account is unsatisfactory because partitive case is not selected as a result of specific selectional properties of the verb, unlike inherent cases (cf.(8), though see Belletti 1988 for an alternative view on this). A structural case account is unsatisfactory because it forces us to conclude that Finnish has a structural case not present in other languages, losing the sense of a universal inventory of features.

## 2.2 The problem with accusative case

There is some controversy over what constitutes accusative in Finnish. Karlsson (1999) states that accusative is the case found on direct objects (when they are not partitive). This, however, means that more than one type of suffix is termed accusative. On most full nominal objects in the singular the suffix is *-n*, which is



identical to the genitive (possessor case).<sup>4</sup> On pronominal objects the suffix is *-t*, which is identical to the plural morpheme of full nouns in the nominative and accusative. This is illustrated in (9).

- (9) Direct objects: *-n* on full nouns, *-t* on pronouns  
 Silja söi leivä-**n** / häne-**t**.  
 Silja ate bread-ACC / him/her-ACC  
 ‘Silja ate the bread / him/her.’

Only the full noun object suffix *-n* is identical to the genitive, whereas the pronoun also has *-n* in the genitive (10), and thus pronominal *-t* is a fully distinct direct object case for pronouns. (11) shows that the *-t* suffix found on direct object pronouns is also the marking of both nominative and accusative plural on full nouns.

- (10) Finnish genitive of possession  
 a. Mari-**n** talo                      b.        hän-**en** kirja-nsa  
       Mari-GEN house                3SG-GEN book-3SG  
       ‘Mari’s house’                    ‘his/her book’
- (11) Plural *-t* on nominative and accusative  
 a. Auto-**t** ovat kadu-lla.        b.        Osta-n auto-**t**.  
       car-PL are street-INESS      buy-1SG car-PL  
       ‘The cars are in the street.’    ‘I buy the cars.’

This suggests that the pronominal *-t* may spell out  $\phi$ P, as I will argue in more detail below.

Some syntactic approaches break away from the traditional theory on accusative. Vainikka (1993), for example, proposes that *-n* is always genitive, the case of nouns in specifier positions and that *-t* is always accusative, assigned to pronouns in direct object position.

Thus the problem with accusative is that it is inconsistently morphologically marked under Karlsson’s approach, and the alternative consistent analysis of the *-n* and *-t* suffixes makes the Finnish case system again appear very exceptional.

### 3 Solution: decomposition in syntax

I propose that partitive, genitive, accusative and nominative relate to functional projections above the noun, below the P level, as illustrated in (12). I treat *-t* consistently as accusative and *-n* as genitive. This is based on their interpretation in the examples in (4-7).

(12) a. Finnish partitive: Q    b. Finnish genitive: D    c. Finnish accusative:  $\phi$

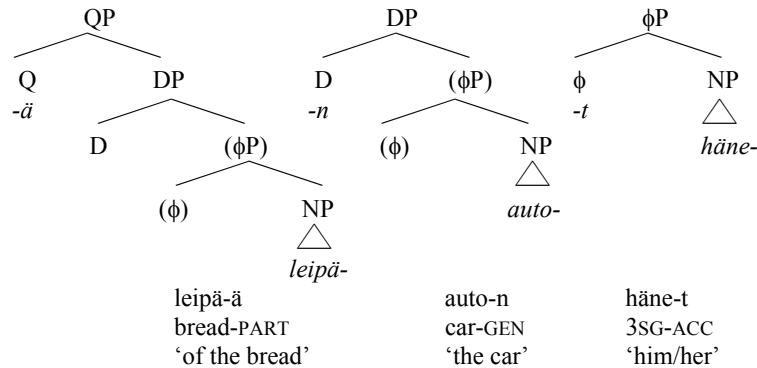

The analysis raises several questions, which will be addressed in the following subsections.

### 3.1 Are the units formed in morphology or syntax?

There are two possibilities for formation of nouns with case affixes: either (i) there is head movement from N-to-D-to-Q etc. (as is standardly assumed for verbal inflection with tense); or (ii) insertion of the full form takes place at the XP-level, blocking spell-out of terminal nodes.

The relative transparency of the Finnish case forms, as compared to the pronominal forms discussed in Déchaine and Wiltschko (2002), suggests we are dealing with movement (option (i)) and spell-out of terminal nodes, rather than spell-out of XP (ii).

### 3.2 Why do nominal direct objects have genitive (possessor case)?

I propose that this is related to the lack of Finnish determiners. In compensation, partitive takes on some of the functions of indefinite determiners or negative polarity items (4-7). Genitive *-n* is the only available definiteness marker, and is thus employed in the absence of a possessor, rather like determiner suffixes in Romanian and Norwegian (13).<sup>5</sup>

- (13) Definite article suffixes (Giusti 2002:58)
- a. băiat-**ul** (Romanian)
  - b. gutt-**en** (Norwegian)
- boy-DEF  
'the boy'

This is in accordance with standard treatment of English *'s* as a determiner (Abney 1987). These suffixes can therefore appear in subject and object positions because they are not assigned by the verb but relate to functional heads in the noun phrase.

Pronouns (NP) are inherently definite, and therefore do not need marking with genitive *-n* when they appear in object position.

### 3.3 What is the status of the accusative *-t* suffix?

I propose that accusative *-t* is a  $\phi$  head, on the basis of the identical form of the nominal plural markers (11). It is employed on singular pronominal objects because these require additional structure to distinguish them from the subject.  $\phi$ P is the nearest available structure. *-t* spells out (number-ambiguous)  $\phi$ , making full nouns plural, but giving the singular pronoun sufficient structure to distinguish it from the nominative subject.

### 3.4 Why don't genitive, partitive and P-affixes combine?

The structures I propose in (12) predict the possibility of combining affixes spelling out P, Q, D and  $\phi$ . Just as it is possible to construct expressions such as *in the house* in English, with separate words, so it should also be possible to construct the same expression with affixes in Finnish, if it relies on the same underlying structure. This however, is not possible in Finnish, as shown in (14).

#### (14) Impossibility of combining D-suffix and P-suffix

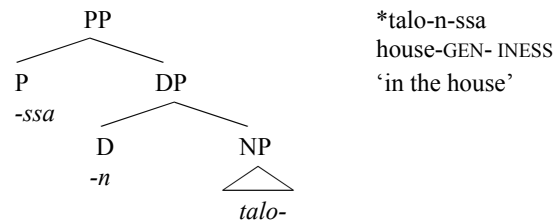

Instead of spelling out all suffixes in such a structure, only the P is spelt out, and the expression is ambiguous with respect to definiteness (15).

#### (15) Ambiguity in interpretation of the lower projection

talo-ssa  
house-INESS  
'in the/a house'

This suggests that there is competition for morphological realisation. Only one slot is available on the noun for realisation of a functional projection and morphological fusion takes place amongst the functional projections. The highest projection present wins, so D is not spelled out when P is present. The one-slot restriction must be both language-specific and function-specific.

Languages do exist where two slots are available. Lezgian, for example, allows case stacking for direction and location, as illustrated in (16).

- (16) Lezgian case stacking: 2 slots (van Riemsdijk 1998)
- |  |   |
|--|---|
| a.        sew-re- <b>qh-aj</b><br>bear-OBL- <b>behind-from</b><br>‘from behind the bear’ | b.        sew-re- <b>k-di</b><br>bear-OBL- <b>under-to</b><br>‘to under the bear’ |
|--|---|

This makes it clear that the one-slot restriction must be language-specific.

It is in fact not the case that Finnish nouns are restricted to one suffix altogether. They can be inflected with possessive agreement suffixes as well as ‘case’ suffixes (17), so more than one slot is available in total. This suggests a qualitative difference between agreement suffixes and  $\phi$ /D/Q/P suffixes, perhaps relating to syntactic position, with agreement relating to the *specifier*, contrasting with the other markings discussed, which relate to *heads* in the extended projection).

- (17) Finnish case and agreement  
 (min-un)talo-**ssa-ni**  
 1SG-GENhouse-INESS-1SG  
 ‘in my house’

This might be further related to the inflection/derivation distinction (18) (cf. Kiefer (1987) on the derivational status of several Hungarian nominal suffixes previously analysed as cases).

- (18) a. Inflection (specifier)                      b. Derivation (head)

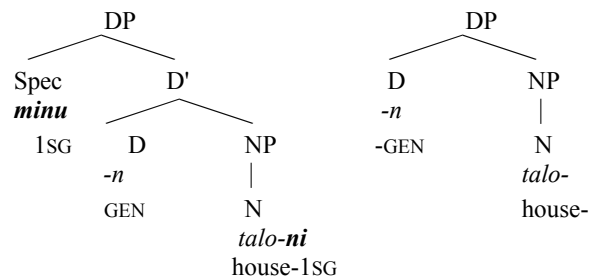

Thus the one-slot restriction is also function-specific.

## 4 Theoretical Implications

The proposal has consequences for the notion of case paradigms and hierarchies, as well as for the inventory of syntactic categories. These consequences are discussed in the following sections.

### 4.1 Case paradigms

If difference case-marked nouns spell out different levels of syntactic structure, then case paradigms exist at the morphological level (listing minimal changes to

words) but not at the syntactic level (since they involve qualitatively different syntactic structures). This appears to be a desirable result, as case paradigms are clearly distinct from paradigms such as person/number agreement on verbs, as compared in (19).

(19) Nominal vs. verbal paradigms in Finnish

Nominal paradigm		Verbal Paradigm	
Form	Gloss	Form	Gloss
talo	house-NOM	sano-n	say-1SG
talo, talo-n	house-ACC	sano-t	say-2SG
talo-n	house-GEN	sano-o	say-3SG
talo-a	house-PART	sano-mme	say-1PL
talo-ssa	house-INESS	sano-tte	say-2PL
talo-sta	house-ELAT	sano-vat	say-3PL
talo-on	house-ILLAT		
talo-lla	house-ADESS		
talo-lta	house-ABL		
talo-lle	house-ALL		

Note the difficulty of finding acceptable minimal sentence pairs when changing case, as compared to changing items of the verbal paradigm (20).

(20) Minimal pairs based on the paradigms in (19)

- a. (Minä) osta-**n** auto-n. / (Sinä) osta-**t** auto-n.  
 1SG buy-1SG car-GEN / 2SG buy.2SG car-GEN  
 'I buy the car.' / 'You buy the car.'
- b. En *pidä* auto-**sta**. / *Aja-n* auto-**n** autotalli-**in**.  
 NEG.1SG like car-ELAT / drive-1SG car-GEN garage-ILL  
 'I don't like the car.' / 'I drive the car into the garage.'

Changing members of the verbal paradigm results in a minimal sentence change, whereas changing the case can necessitate a complete change of predicate.

#### 4.2 Case hierarchies

The proposal requires a revision of previously outlined case-hierarchies, such as that in (21). Such hierarchies are designed to determine the likelihood that a language has a particular case. For example, if it has instrumental case, it will have at least all those preceding it on the hierarchy.

(21) Schematic implicational hierarchy of cases (Blake 1994)

NOMINATIVE > ACCUSATIVE / ERGATIVE > GENITIVE > DATIVE >  
 LOCATIVE > ABLATIVE / INSTRUMENTAL > others

There are several problems with this. Firstly the position of genitive in (21) cannot be correct, since Hungarian has dative and others, but no genitive. Moving genitive

down the hierarchy does not help because German and Greek have nominative, accusative, genitive, and dative, but no others.

Under the present proposal the hierarchy determines the likelihood of spell-out as an independent word or as an affix (cf. van Riemsdijk 1981). Nominative, accusative and genitive need not fit into the hierarchy because they do not form a natural class with those lower in the list (P).

### 4.3 Syntactic categories

The reanalysis of some cases as D-inflection makes it possible to give a more semantically consistent characterisation of the category P (location/direction and semantic roles), without expanding significantly the semantic coverage of the categories D and Q. We can dispense with the notion of Case and K-projections, as apparent ‘structural’ cases are distinguished by their D/Q-status, without reference to a separate category K or case features. This has the advantage of reducing the inventory of categorial primitives.

Spencer (2006) presents several different possible notions of case, including the following.

Type 1. Cumulated case:

Morphological feature [Case] required to generalise over declension classes or cumulation with other features (num, def, poss, etc.).

Type 2. Syntactic case:

Syntactic feature [CASE] needed to generalise over any kind of ‘agreement’, etc.

Under the standard view, Type 1 could be applied to Finnish accusative on pronouns (-t) and full nouns (-n) in direct object position. However, here this is analysed as relating to different requirements of full nouns and pronouns, so this notion of case is no longer necessary to account for Finnish. Type 2 might also apply to Finnish, since adjectives agree with the noun in case (22).

- (22) Finnish adjective agreement
- |                      |                  |
|----------------------|------------------|
| iso- <b>ssa</b>      | talo- <b>ssa</b> |
| big-INESS            | house-INESS      |
| ‘in the/a big house’ |                  |

However, an alternative analysis of agreement of the adjective with functional projections of the noun is necessary for independent reasons. Hungarian demonstratives, for example, agree with both cases and postpositions (23), where it is standard to analyse at least the postposition as a head, and the same could be argued for the case suffix on the basis of similarities in behaviour with the postposition (cf. Asbury to appear).

- (23) Hungarian demonstrative agreement
- |    |                 |     |                 |
|----|-----------------|-----|-----------------|
| a. | en- <b>nél</b>  | a   | ház- <b>nál</b> |
|    | this-ADESS      | the | house-ADESS     |
|    | ‘at this house’ |     |                 |

- b.      az      **alatt**    a      fa      **alatt**  
           that    under    the    tree    under  
           ‘under that tree’

Furthermore, adjectives agree for definiteness in some languages (24), where it is well established that definiteness relates to a D projection.

- (24)    Determiner agreement on the adjective, Swedish (Kester 1996)  
           den      stor-**a**    bil-**en**  
           the      big-DEF car-DEF  
           ‘the big car’

Although I cannot offer an analysis of such phenomena here, it seems clear that a mechanism must be allowed for, whereby adjectives and demonstratives agree with *functional projections* in the noun phrase, not only with *features* of the noun. Spencer mentions some other possible notions which could be termed case, such as semantic role, but claims that a language need only be analysed as having a case system if it has one or other of the types mentioned above. Since I have argued that apparent instantiations of both type 1 and type 2 in Finnish can be related to independent factors, it seems possible to argue that Finnish does not require case-specific notions.

## 5 Conclusion

I have argued that Finnish morphological cases spell out different extended projections of the noun: P (spatial cases), Q (partitive *-a*), D (genitive *-n*),  $\phi$  (accusative *-t*), N (nominative  $-\emptyset$ ). Case specific features and projections are unnecessary, since cases can be attached to projections already independently required in the syntax. Case paradigms exist at the morphophonological level, not the syntactic level. Spell-out of functional heads on the noun is determined by competition, with the number of slots being determined language-specifically. Agreement slots and functional projection slots are qualitatively different, and as such do not come into competition with one another for spell-out.

- (25)    Breakdown of the Finnish case paradigm

case	‘bear’	underlying syntax
Nominative	<i>karhu</i>	NP
Accusative	<i>(hän-et ‘him’)</i>	$\phi$ P
Genitive	<i>karhu-n</i>	DP
Partitive	<i>karhu-a</i>	QP
Inessive	<i>karhu-ssa</i>	PP
Elicative	<i>karhu-sta</i>	
Illative	<i>karhu-un</i>	
Adessive	<i>karhu-lla</i>	
Ablative	<i>karhu-lta</i>	
Allative	<i>karhu-lle</i>	

## Notes

<sup>1</sup> Many thanks to Norbert Corver, Jan Don, Martin Everaert, Marijana Marelj, Maaïke Schoorlemmer, Peter Svenonius and Joost Zwarts for their comments on previous drafts of this paper and discussion of the issues involved.

<sup>2</sup> Parentheses indicate that the enclosed categorial projection may not be present in every noun phrase.

<sup>3</sup> For the purposes of discussion of the partitive, I use the term ‘accusative’ for the alternate case on objects, in accordance with much literature on the topic (Kiparsky 1998, Karlsson 1999). In Section 3 I propose a different analysis of the *-n* suffix, here glossed as accusative.

<sup>4</sup> Full noun objects can also be zero-marked in certain contexts, when they are objects of first or second person imperatives. I will not attempt to account for this here.

<sup>5</sup> Equating partitive and genitive with quantity and definiteness oversimplifies matters somewhat. Kiparsky (1998), Kratzer (2004) and others show that partitive, genitive and accusative have effects on the aspect of the verb in some contexts, where the interpretation of the noun as definite or indefinite is ambiguous.

## References

- Abney, Stephen. 1987. *The English Noun Phrase in its Sentential Aspect*. MIT: doctoral dissertation.
- Asbury, Anna. to appear. ‘Marking of Semantic Roles in Hungarian Morphosyntax’, *Approaches to Hungarian*, 10. Chris Piñón (ed.).
- Beard, Robert. 1995. *Lexeme-Morpheme Base Morphology*. Albany: State University of New York Press.
- Belletti, Adriana. 1988. ‘The Case of Unaccusatives’, *Linguistic Inquiry*, 19:1-34.
- Bittner, Maria and Hale, Kenneth 1996. ‘The Structural Determination of Case and Agreement’. *Linguistic Inquiry*, 27:1-68.
- Blake, Barry. 1994. *Case*. Cambridge: CUP.
- Chomsky, Noam. 1981. *Lectures on government and binding: the Pisa lectures*. Dordrecht: Foris.
- Chomsky, Noam. 1995. *The Minimalist Program*. Cambridge, MA: MIT Press.
- Déchainé, Rose-Marie, and Wiltschko, Martina. 2002. ‘Decomposing Pronouns’, *Linguistic Inquiry*, 33:409-42.
- Emonds, Joseph. 1985. *A unified theory of syntactic categories*. Dordrecht: Foris.
- Fillmore, Charles. 1968. ‘The Case for Case’, *Universals in Linguistic Theory*, E. Bach and R. T. Harms (eds.), New York: Holt, Rinehart and Winston.
- Fong, Vivienne. 2001. ‘“Into doing something”: Where is the Path in event predicates?’, Ms. National University of Singapore.
- Giusti, Giuliana. 1995. ‘A unified structural representation of (abstract) case and article: evidence from Germanic’, *Studies in Comparative Germanic Syntax*, H. Haider, S. Olsen and S. Vikner (eds.), 77-93. Dordrecht: Kluwer.
- Grimshaw, Jane. 2000. ‘Extended Projections and Locality’, *Lexical Specification and Insertion*, Peter Coopmans, Martin Everaert and Jane Grimshaw (eds.), 115-33. Amsterdam/Philadelphia: John Benjamins.
- Karlsson, Fred. 1999. *Finnish: an Essential Grammar* London: Routledge.
- Kester, Ellen-Petra. 1996. *The Nature of Adjectival Inflection*. Utrecht Institute of Linguistics OTS, Utrecht University: doctoral dissertation.
- Kiefer, Ferenc. 1987. ‘The Cases of Hungarian Nouns’, *Acta Linguistica Academiae Scientiarum Hungaricae* 37:93-101.
- Kiparsky, Paul. 1998. ‘Partitive Case and Aspect’, *The Projection of Arguments*, Miriam Butt and Wilhelm Geuder (eds.), Stanford: CSLI Publications.



- Kratzer, Angelika. 2004. 'Telicity and the Meaning of Objective Case', *The Syntax of Time*, Jacqueline Guéron and Jacqueline Lecarme (eds.), 389-423. Cambridge, MA: MIT Press.
- Nikanne, Urpo. 1991. *Zones and Tiers: A Study of Thematic Structure*. University of Helsinki: doctoral dissertation.
- Riemsdijk, H. van. 1981. 'The Case of German Adjectives', *University of Massachusetts Occasional Papers in Linguistics 6: Markedness and learnability*. J. Pustejovsky and V. Burke (eds.), 148-72. Amherst: GLSA University of Massachusetts.
- Riemsdijk, Henk van. 1998. 'Categorial feature magnetism: The endocentricity and distribution of projections', *Journal of Comparative Germanic Linguistics* 1-48.
- Riemsdijk, Henk van, and Huybregts, Rini. 2001. 'Location and Locality', *Progress in Grammar*, M. van Oostendorp and E. Anagnostopoulou (eds.), 1-23. Utrecht and Meertens Institute Amsterdam: Roccade.
- Spencer, Andrew. 2006. 'Does Hungarian have a case system?' Paper presented at the Annual Meeting of the Linguistics Association of Great Britain, University of Newcastle, 30<sup>th</sup> August-2<sup>nd</sup> September 2006.
- Vainikka, A. 1993. 'Three Structural Cases in Finnish', *Case and other Topics in Finnish Syntax*, A. Holmberg and U. Nikanne (eds.), 129-59. Dordrecht: Kluwer.

Anna Asbury  
 Utrecht Institute of Linguistics OTS  
 Utrecht University  
 Janskerkhof 13  
 3572AD Utrecht  
 The Netherlands  
 Anna.Asbury@let.uu.nl

# One size fits all: prefixes, particles, adpositions and cases as members of the category P

Anna Asbury, Berit Gehrke and Veronika Hegedűs  
Utrecht Institute of Linguistics OTS and Tilburg University<sup>1</sup>

## 1 Introduction

Recent research on adpositions (Van Riemsdijk 1990, Koopman 1997, Van Riemsdijk and Huybregts 2001, Helmantel 2002, Den Dikken 2003, Svenonius 2004) focuses on the division of labour between direction and location heads in the extended projection of PP. Give or take functional structure and with varying labels there is a general consensus on the structure in (1).

- (1) [PathP [PlaceP [DP ]]]

The aim of this paper is to defend the view that particles, prefixes, adpositions and cases belong to the category P and to provide an analysis that integrates prefixes/particles and cases into the structures found in research on adpositions. We will thus provide new evidence in support of work uniting prefixes/particles and prepositions (Jackendoff 1973, Emonds 1976, Van Riemsdijk 1978, Den Dikken 1995, Zeller 2001, Matushansky 2002) and uniting prepositions and cases (Fillmore 1968, Emonds 1985).

Several arguments have been brought forward for drawing a categorial distinction between the items subsumed here under the category P. Firstly, prepositions are traditionally regarded as case *assigners* in view of the following type of data from German (2).<sup>2</sup>

- (2)     **aus**     **dem**     Haus  
          out     the.DAT house  
          ‘out of the house’

If prepositions are case *assigners*, they cannot be of the same category as cases.

However, not all prepositions visibly combine with cases on the noun, and those that do could be seen as analogous to combinations of Ps and combinations of cases. For example, there are languages such as Lezgian that employ case suffixes

to express the spatial meanings primarily associated with English prepositions (3) (see also Kracht 2002 for discussion).

- (3) a.      **sewre-*qh-aj***                      b.      **sewre-*qh-di***  
          bear-POSTESS-ELAT                      bear-POSTESS-DIR  
          ‘**from behind** the bear’                      ‘**to behind** the bear’  
          (from Van Riemsdijk and Huybregts 2001)

Furthermore, it has been proposed for Hungarian that there is a split between true Ps, which are inflecting postpositions and case suffixes, and adverbs, which are non-inflecting postpositions (É. Kiss 2002). We do not adopt this approach, but rather adhere to the view commonly held in the Principles and Parameters framework that adverbs are not a separate category, but rather a function. The category P may play a fundamental part in giving other categories an adverbial function in many contexts.

A more serious problem for a unified treatment of particles/prefixes, adpositions and cases under one category P is the fact that not all these elements can appear in all P-positions. Furthermore, some elements subsumed here under P interact with aspect whilst others do not. We will provide a structural analysis that can account for the different orders and meanings while still maintaining the claim of the categorial identity of P. The differences, then, boil down to mere morphological ones, which can be accounted for in the spell-out of the different items.

Since we focus primarily on P elements with spatial meaning, we do not discuss structural cases (nominative and accusative), Germanic inseparable prefixes (e.g. German *ver-*, *ent-* or other non-spatial items with a distribution overlapping that of the items discussed here (e.g. Hungarian particles *meg*, *el*). The paper is organised as follows. Section 2 provides evidence from different languages that prefixes/particles, adpositions and cases belong to one category on the basis of their similar forms and meanings. Section 3 proposes a structure to account for differences in word order, morphological status and meaning. Section 4 discusses the issue of limiting the category P. Finally, section 5 concludes.

## 2 Evidence

### 2.1 Prefixes/Particles and Adpositions

Prefixes/particles and prepositions/postpositions often have similar forms and interpretations. For example, Dutch *in* ‘in’ can appear as a prefix/particle, a postposition or a preposition (4).

- (4) a.      Zij      wou      het meer **in-zwemmen**.      (prefix/particle)  
          she      wanted      the lake in-swim  
          ‘She wanted to swim **into** the lake.’  
       b.      Zij      zwom      het meer **in**.      (postposition)  
          she      swam      the lake in  
          ‘She swam **into** the lake.’

- c. Zij zwom **in** het meer. (preposition)  
 she swam in the lake  
 ‘She swam **in** the lake.’

(4a-b) illustrate that the meaning of Dutch *in* as prefix/particle or as postposition are identical. (4b) and (4c) show that Dutch makes a locative/directional distinction (English *in* vs. *into*) by using this adposition as a pre- or postposition.

German also has forms such as *auf* ‘on’ that have the same meaning as a prefix, preposition or postposition.<sup>3</sup>

- (5) a. Sie wollte **auf** den Berg hin-**auf**-laufen.  
 she wanted on the.ACC mountain there-on-run  
 ‘She wanted to run up the mountain.’  
 b. Sie lief **auf** den Berg hin-**auf**.  
 she ran on the.ACC mountain there-on  
 ‘She ran up the mountain.’

Similar examples are found in Latin, Slavic languages, Ancient and Modern Greek.

We now take a closer look at Russian and Czech prefixes and prepositions that are used to express sources and goals. The following tables provide an overview of the inventory in Russian and Czech.

meaning	prepositions	verbal prefixes
to	<i>do</i> (+ GEN), <i>k</i> (+ DAT)	<i>do-</i> , <i>pri-</i>
towards	<i>k</i> (+ DAT)	–
in / into	<i>v</i> (+ ACC) / (+ PREP)	<i>v-</i> , <i>za-</i>
on / onto	<i>na</i> (+ ACC) / (+ PREP)	( <i>na-</i> )
(away) from	<i>ot</i> (+ GEN)	<i>ot-</i> , <i>u-</i>
out of	<i>iz</i> (+ GEN)	<i>iz-</i> , <i>vy-</i>

Table 1. Russian goal and source prepositions and prefixes

meaning	prepositions	verbal prefixes
to	<i>do</i> (+ GEN), <i>k</i> (+ DAT)	<i>do-</i> , <i>při-</i>
towards	<i>k</i> (+ DAT), <i>vůči</i> (+ DAT)	–
(in)to	<i>do</i> (+ GEN)	<i>do-</i>
on / onto	<i>na</i> (+ ACC) / (+ PREP)	( <i>na-</i> )
(away) from	<i>od</i> (+ GEN)	<i>od-</i> , <i>u-</i>
out of	<i>z</i> (+ GEN)	<i>vy-</i>

Table 2. Czech goal and source prepositions and prefixes

An apparent difference between Russian and Czech is that only Czech has a preposition like *towards* distinct from *to*, namely *vůči*. In addition, Czech does not lexically distinguish *into* from *to* but uses the preposition *do* in both cases.

At first sight, the gaps in the preposition-prefix correlation (marked in bold-faced letters) seemingly pose a problem for our claim that they belong to the same category. There are direct prefixal counterparts to all locative prepositions but not to the purely directional ones *k* ‘to(wards)’ and *vůči* ‘towards’. On the other hand,

there are cases where the prefixes used to refer to goals or sources do not have prepositional counterparts with the same meaning. These prefixes are in fact often preferred over the direct counterparts to render the particular meanings of goal and source. We can show, however, that prefixes on Slavic motion verbs convey locative rather than directional meanings and thus account for the gap and maintain a unified treatment of prefixes and prepositions under the category P.

Apart from Czech *vůči* ‘towards’, Russian *v* (+ ACC) ‘into’, and Russian and Czech *k* ‘to(wards)’ and *na* (+ ACC) ‘on’, all goal and source prepositions can appear in both directional and locative contexts. Moreover, *na* and *v* convey the locative meanings of ‘on’ and ‘in’, respectively, when they select prepositional case<sup>4</sup>, as the examples from Russian in (6) show (Czech *na* ‘on’ behaves the same).

- (6) a. Ona položila knihu        na stol                / v sumku.  
 she put.PAST book.ACC    on table.ACC        / in bag.ACC  
 ‘She put the book onto the table / into the bag.’ (directional)
- b. Kniga                        byla        na stole                / v sumke.  
 book.NOM                was        on table.PREP        / in bag.PREP  
 ‘The book was on the table / in the bag.’ (locative)

Hence, these prepositions also occur in locative contexts. The only prepositions that can never appear in a locative context are therefore Russian and Czech *k* ‘to(wards)’ and Czech *vůči* ‘towards’, which are exactly those prepositions that do not have prefixal counterparts.

The prepositional counterparts of the additional prefixes that are in some cases preferred over the direct counterparts to render the particular meanings of goal and source, partially convey different meanings (7).

- (7) Prepositional counterparts to additional prefixes:
- a. *pri* / *při* (+ PREP) ‘at, by’
- b. *u* (+ GEN) ‘at’
- c. *za* (+ ACC / INSTR) ‘within; behind, at, with, ...’
- d. Old Slav. *vbъn* (+ GEN) > Russ./Czech *von/ven* ‘outside’

The most common prefixes used for a motion involving arrival or leaving have the prepositional counterparts in (7a-b). As prepositions, these elements convey the purely locative meaning ‘at’. Furthermore, the prefix *za-* ‘in’ has the prepositional counterpart *za* ‘within; behind’, which is used directionally to mean ‘behind’ (then selecting ACC). As a prefix, however, it denotes ‘in’, so only the locative meaning is available. Finally, the prefix *vy-* ‘out’, which no longer has a prepositional counterpart, is historically related to the Old Slavonic preposition *v"n*. Reflexes of this preposition are the modern Russian and Czech adverbials *von* / *ven* ‘outside’, so that we can assume that this element is not directional either.

We therefore conclude that prefixes on Russian and Czech motion verbs in goal and source contexts are locative and have direct counterparts among the prepositions (see also Matushansky 2002 for morphophonological evidence that Russian prefixes and prepositions have the same status).<sup>5</sup> Overall, prefixes and particles are closer to the verb, whereas adpositions are closer to the noun and this

important difference between these two kinds of elements should not be blurred. Nevertheless, we take the general identity of form and meaning between prepositions/postpositions and prefixes/particles in different languages as evidence that they belong to the same category.

## 2.2 Tying in Cases

This section looks at semantic and morphological evidence that bound morphemes with spatial interpretations commonly termed ‘case’ in many languages belong to the category P. This represents a departure both from traditional approaches to grammar, where a bound morpheme would be treated as case and a separate word as an adposition, as well as from the mainstream approach in the Principles and Parameters framework (Chomsky 1995), which treats case as an uninterpretable feature and P as a lexical category. Whilst case has been connected with adpositions in the generative literature (see for English Fillmore 1968, Emonds 1985, for German Vogel and Steinbach 1998, Bayer *et al* 2001, for Finnish Nikanne 1991, Kracht 2002, for Lezgian Van Riemsdijk and Huybregts 2001), our approach, in addition to providing new evidence for this unification, extends it to include verbal particles.

(8) shows that where English uses only adpositions in spatial expressions, German case makes a contribution to spatial interpretation, and is not merely an uninterpretable feature assigned by the adposition (see Gehrke 2006 for discussion).

- (8) a. auf den Berg  
on the.ACC mountain  
‘onto the mountain’ (directional)
- b. auf dem Berg  
on the.DAT mountain  
‘on the mountain’ (locative)

In (8) the morphological distinction between cases (affixes) and adpositions (full words) is clear. Hungarian, however, constitutes a challenge to a theory that draws the line between cases and adpositions based on their morphological status (see Asbury 2005, Asbury to appear for a more detailed examination of the Hungarian data). Data here is adapted from Marác 1989 and É. Kiss 2002.

Hungarian cases form suffixes when they combine with full nouns, but appear to form the head of the word with pronouns, as shown in (9).

- (9) a. a ház-**ban** b. (én) **benn-em**  
the house-INESS (I) INESS-1SG  
‘in the house’ ‘in me’

In exhibiting this agreement pattern, case is similar to the majority of the Hungarian postpositions (10).

- (10) a. (én) **benn-em**                      b. (én) **mögött-em**  
 (I) INESS-1SG                              (I) behind-1SG  
 ‘in me’    ‘behind me’

The main distinguishing factor between the postpositions which inflect in this way (10b) and the morphemes termed ‘cases’ is vowel harmony, exhibited by the cases but not the adpositions (11).

- (11) a. a ház-ba/\*-be                      / a zsebé-be/\*-ba  
 the house-ILL                              / the pocket-ILL  
 ‘into the house’                              / ‘into the pocket’  
 b. a ház mellett/\*mallatt              / a zseb mellett/\*mallatt  
 the house near                              / the pocket near  
 ‘near the house’                              / ‘near the pocket’

It could be argued, however, that this is a morphological process, calculated after the syntax on the basis of the quantity of phonological material inserted. Note that nearly all postpositions are polysyllabic, the few exceptions containing a vowel which does not undergo harmony due to the quality of the vowel itself, whereas most putative cases are monosyllabic. Thus it may be that those items which undergo vowel harmony do so because they are too light to be phonologically independent, rather than because of an underlying syntactic difference.

The inflection-word distinction is sometimes applied to cases and adpositions on the basis that agreement can be seen with inflectional categories (e.g. Latin adjectives have case suffixes agreeing with the noun), whereas independent words do not agree. Again, Hungarian blurs this distinction, since only the demonstrative appears to agree, both in number and ‘case’. However, it is not only the putative case suffixes but also the majority of postpositions (those that inflect when combined with pronouns) which require agreement after the demonstrative (12).

- (12) a. en-**nél**                      a ház-**nál**  
 this-ADESS                      the house-ADESS  
 ‘at this house’  
 b. az **alatt**                      a fá **alatt**  
 that under the tree under  
 ‘under that tree’

The same postpositions exhibit ordering restrictions which make them appear rather like case suffixes. Modifiers such as *majdnem* (‘almost’), for example, cannot intervene between noun and postposition (13).

- (13) a. majdnem az utcá-**ban**  
 almost the street-INESS  
 ‘almost in the street’  
 b. (majdnem) a ház (\*majdnem) **mellett**  
 (almost) the house (\*almost) near  
 ‘almost by the house’

A significant minority of postpositions exhibits fewer similarities to the case suffixes by not agreeing with pronouns and permitting intervention of the modifier (13). However, it is difficult to draw a line between the two types of postposition, since there are items which exhibit mixed behaviour. For instance, the postposition *kívül* ('outside') behaves variably with respect to pronominal inflection (14).

- (14)    *kívül-em*            /            *rajt-am kívül*  
           outside-1SG        /            SUP-1SG outside  
           'outside me'

Thus the adposition-case distinction seems not to exist in Hungarian, even on the basis of morphosyntactic diagnostics.

Finally, Hungarian allows us to make the link with the other categories we subsume here under P. It appears that in Hungarian not only the postpositions (15b), but even the cases (15a) can surface as verbal prefixes/particles.

- (15)    a.            *János rá-lépett*            a            *láb-am-ra*.  
           János    SUB-stepped        the            foot-1SG-SUB  
           'János stepped on my foot.'  
           b.            ***Körül-néztünk***    az üzlet-ben.            az üzlet ***körül / körülött-em***  
           round-looked    the shop-INESS        the shop round / round-1SG  
           'We looked around the shop.'            'round the shop' / 'round me'

To conclude, Hungarian provides evidence against a strict categorial distinction between case and postpositions on the basis of morphosyntactic characteristics. Even in languages where the morphosyntactic distinction is clear-cut, we view the semantic overlap as evidence in favour of treating them as one category.

### 3 Structural Analysis

Building on insights from recent research on the structure of adpositions and the projections associated with these (Van Riemsdijk 1990, Koopman 1997, Helmantel 2002, Den Dikken 2003, Svenonius 2004), we propose to account for the different distributions of the items subsumed here under the category P with the skeleton structure in (16).

- (16)     $[_{IP} I [_{PredP} Pred [_{VP} V [_{VP} V [_{PathP} Path [_{PlaceP} Place [_{DP} \dots ]]]]]]]]$

In a nutshell, each individual lexical item has its own core semantics (locative or directional). On the basis of this, a particular P is merged in the extended projection of the noun phrase as either Place or Path, where the heads can head a small clause with the verb-internal argument as its subject. The final position with respect to noun and verb is determined by syntactic movement. Furthermore, the core semantics of particular Ps can make them incompatible with certain positions, for



example preventing them from becoming particles/prefixes, or from licensing/identifying (directional) Path structure.

Let us run through some examples to illustrate the main idea of our proposal. Locative Ps such as *under*, *behind*, *in*, *on*, and *at* are associated with Place (17).

(17) [PlaceP [Place *behind* [DP *the house* ]]]

Simple directional Ps such as *to* and *from*, as well as complex directional PPs such as *into*, *onto*, and *from under*, license a PathP which embeds a PlaceP. The Place head is either empty (with simple directional Ps) or filled with a locative P element which is part of the complex PP (18).

(18) [PathP [Path *from* [PlaceP [Place *behind* [DP *the house* ]]]]]

The difference between prepositions and postpositions can be accounted for in the following way. Assuming a universal Spec-Head-Comp ordering, with P preceding DP in its initial position, postpositions in Hungarian and Dutch, for instance, are the result of DP-raising to Spec-Path/Place as appropriate.

Dutch postpositional phrases, which are always directional, are the result of the DP-complement of a Place head moving to Spec-PathP, thereby licensing or identifying the additional Path structure (19).

(19) *het meer in*  
*the lake in*  
'into the lake'

Hungarian postpositional phrases can be either locative or directional. For the locative cases we propose that the DP-complement of PlaceP moves only as far as Spec-PlaceP (20). Thus Path structure is not licensed by the movement, as it is in Dutch.

(20) *a ház mögött*  
*the house behind*  
'behind the house'

Hungarian directional postpositions are the result of DP-movement to the Specifier of a directional P element. In a PathP with both directional and locative semantics, either the head of the Place projection is empty as illustrated in (21), or the locative Place head moves to incorporate into the Path head. Both options are compatible with our proposal.

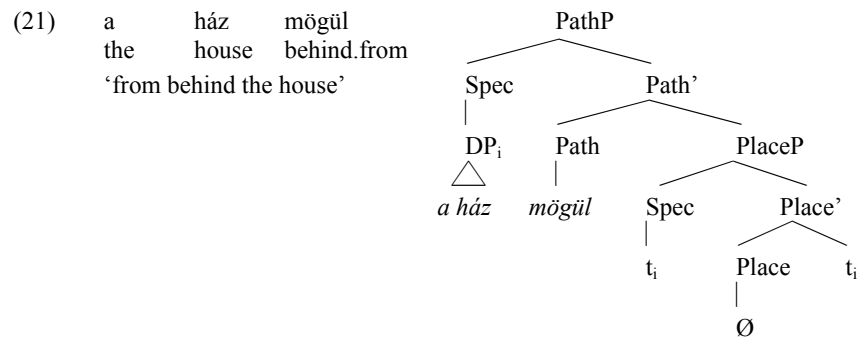

The difference between case suffixes and postpositions in Hungarian results from phonological processes after Spell-Out, at PF, with morphological merger between DP and P after movement.<sup>6</sup> Hence, the structure itself remains the same.

Most Germanic, Slavic and Hungarian particles/prefixes with spatial semantics seem to function as a kind of glue between the verbal and the nominal domain. In particular, they seem to participate in structuring the event expressed by the VP and the DPs/PPs contained therein. We take this effect to be due to subsequent movement of the P element from the extended PP to a position above VP (and vP where present), which we assume to be PredP (following Baker 2003 and others). In Hungarian, such elements move to PredP in the default case (22) (see Hegedűs 2005 for discussion on Hungarian PPs). (23) provides an example from German with the entire PathP moved up to Spec-PredP.

- (22) Mari fel-mászott a hegy-re.  
Mari up-climbed the hill-SUB  
'Mary climbed up the hill.'

- (23) Sie ist auf den Berg hin-auf-gelaufen.  
she is on the.ACC mountain there-on-run  
'She ran up the mountain.'

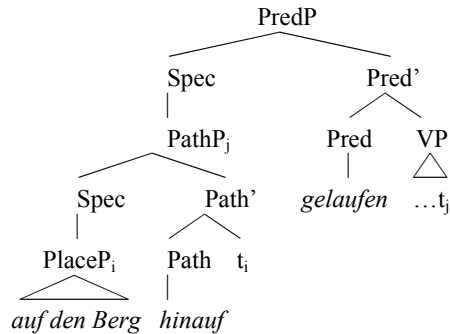

Hence, the problem of the uneven distribution of different P elements, usually taken as evidence for treating them as categories in their own right, can be accounted for by assuming that the core lexical semantics of a particular P determines the position in which it is merged. Adpositions, prefixes/particles and cases alike can appear in Path, Place or PredP, and at the same time, there are adpositions, prefixes/particles and cases that are banned from certain positions. Thus, the distinction between these elements turns out to be merely a morphological one, where the precise morphological analysis must remain for future research.

#### 4 Limiting the category P

If we extend the category P to elements beyond adpositions, such as cases and prefixes/particles, the question arises how this category is limited.<sup>7</sup> It goes beyond the scope of this paper to give a full definition of the category P. A distinction, however, should be drawn between derivational processes which relate semantically and formally similar words and the types of semantic and formal similarity we point out here with respect to the category P. Examples of the former type are English *run*, which can be a noun or a verb, and pairs such as *high* and *height*. In these instances there is a clear categorial difference, also resulting in a clear semantic difference, in spite of the similarity (24).

- (24) a. He has run a long way today. (V)  
 b. He went on a long run today. (N)

*Run* (V) denotes the activity of running, whereas *run* (N) denotes an event in which someone engages in the activity of running. A word such as *up*, however, does not undergo such a change of meaning in the transition from being a preposition (*up the hill*) to being a particle (*went up*). Instead, the difference is the way in which *up* relates to the rest of the sentence, the preposition denoting the path with respect to a specific place, *on the hill*, and the particle denoting the path which specifies the action. Thus the difference is contributed by the other parts of the sentence, not by a derivational difference in *up* itself.

Even under the view that roots are inserted without categorial labels and that all derivational processes (like *run* V/N, *high/height*) take place in syntax (cf. Halle and Marantz 1993, Marantz 1997), the relation between particles and adpositions can still be viewed as distinct under the present proposal. The zero derivation process from *run* (V) to *run* (N), for example, would require addition of nominal structure to form a noun and verbal structure to form a verb. Under our proposal an adposition would be formed on insertion with the requisite syntactic structure, and a particle would be formed by movement of this item within the sentence structure. Thus the formation of a particle from a preposition, we argue, does not require additional or different structure, but rather movement of the P head within the structure already present. This might rather be compared to the change in function of a direct object under topicalisation (25).

(25) *This book*<sub>i</sub>, I've read many times t<sub>i</sub>.

We view *particle* as a functional description, rather than a categorial one. Like adverbs, several different categories can be used as particles, often having the effect of making the event resultative or telic (26). *Flat*, in interacting with aspect in this way, is no less an adjective than when it is used predicatively or attributively (27).

(26) a. He hammered the metal *flat*.  
b. He handed the article *in*.

(27) a. The metal was flat.  
b. flat metal

In the same way, we argue that particles derived from adpositions are no less members of the category P (cf. Baker 2003 for a deeper discussion and analysis of similarities between the categories A and P).

As mentioned in the introduction, there are also elements we do not discuss, which have a distribution overlapping with the Ps discussed here. The category P can be informally characterised as expressing spatial relations and thematic roles. In this paper we have focused on words and affixes expressing spatial expressions. We expect the same analysis to carry over to words and affixes expressing thematic roles, particularly in view of the fact that certain elements sharing the distribution of Ps discussed above can express both spatial meaning and also meaning associated with thematic role, as illustrated with Hungarian dative case in (28).

(28) a. Csillá-**nak**      adtam      egy      könyv-et.  
Csilla-DAT      gave.1SG      a      book-ACC  
'I gave Csilla a book.' (recipient role)

b. **Nek-i**-mentem      a      fal-**nak**.  
DAT-3SG-went      the      wall-DAT  
'I bumped into the wall.' (path)

However, this connection remains to be shown in detail in future research, with some doubt as to whether there is a correlate of the path-place distinction from spatial expressions amongst their non-spatial counterparts.

Whether the proposal could be further extended to other particles and prefixes with non-spatial meanings (e.g. German *ver-* and *ent-*, Hungarian *meg-*) seems less certain. Whilst these elements do not appear to be related to the category A, the evidence for relating them to the category P is also not clear. The type of formal and semantic similarities we have used as evidence above clearly would not carry over to this class of prefixes and particles. Applicative markers, which can also be used in both spatial and thematic expressions, are another area where it would be interesting to attempt to extend the proposal, but where further work would be required. Finally, we rule out the possibility of extending the proposal to nominative and accusative case, following the mainstream Principles and Parameters view that these are purely uninterpretable features.

The proposal in this paper thus contributes to the delineation of the category P, allowing us to subsume certain elements under this categorial label but also to rule out a connection with other elements whose distribution sometimes overlaps with that of P.

## 5 Conclusion

In this paper, we have presented semantic and morphological evidence that prefixes/particles, adpositions and cases belong to one category, P. We explained apparent counterevidence with a structural analysis whereby movements within the extended projection above the noun derive different adposition-noun ordering and combination phenomena, and prefixes/particles are formed by movement to PredP.

Possible extensions of the current account could examine Ps with non-spatial meaning, Ps selected by specific verbs (e.g. *believe in*, *phone up*), where the P would normally have a spatial meaning but does not in specific P-verb combinations, metaphorical extensions from spatial Ps (e.g. temporal *at*, *up to*; general metaphorical use, *prices go up*), and more speculatively, applicatives. Finally, a full account should also address Ps such as *with*, *without*, *as*, comitatives, and instrumentals, which seem never to express spatial meaning.

## Notes

<sup>1</sup> We would like to thank Joost Zwarts, Henriëtte de Swart, Henk van Riemsdijk, Jakub Dotlačil, Hans Broekhuis, Seiki Ayano, and an anonymous reviewer for comments on earlier drafts.

<sup>2</sup> The following abbreviations are used in the example glosses: ABL = ablative, ACC = accusative, ADESS = adessive, ADJ = adjective, AGR<sub>o</sub> = object agreement, AGR<sub>s</sub> = subject agreement, APPL = applicative, CL = clitic, DAT = dative, DEL = delative, DIR = directional, ELAT = elative, ESS = essive, FEM = feminine, FUT = future, GEN = genitive, ILL = illative, INESS = inessive, INSTR = instrumental, PERF = perfect, PFX = prefix, PL = plural, POSTESS = postessive, PREP = prepositional case, SG = singular, SUB = sublative, SUP = superessive, T/A = tense/aspect, TERM = terminative.

<sup>3</sup> In contrast to Dutch, German marks the locative/directional distinction by means of case on the DP-complement of the preposition (see Gehrke 2006 for discussion).

<sup>4</sup> The prepositional case in Slavic languages is sometimes also called locative case. We chose this term to avoid confusion with the term *locative* which we reserve for the spatial meaning of places/locations in contrast to *directional*, which relates to paths.

<sup>5</sup> Gehrke to appear provides arguments for treating Slavic prefixes as state morphemes expressing a result state in a complex event structure expressed by the VP and the DPs/PPs therein.

<sup>6</sup> Hungarian spatial case suffixes developed diachronically from postpositions.

<sup>7</sup> Our thanks to Joost Zwarts, Jakub Dotlačil and an anonymous reviewer for emphasising the importance of this question and pointing out some of the issues raised below.

## References

- Asbury, Anna. 2005. 'Adpositions as Case Realisations: Structures and Consequences', *Leiden Working Papers in Linguistics* 2:69-92.
- Asbury, Anna. forthcoming. 'Marking of Semantic Roles in Hungarian Morphosyntax', ed. C. Piñón *Approaches to Hungarian* 10.
- Baker, Mark. 2003. *Lexical Categories: Verbs, Nouns, and Adjectives*. Cambridge: CUP.
- Bayer, Joseph, Bader, Markus, and Meng, Michael. 2001. 'Morphological underspecification meets oblique case: Syntactic and processing effects in German', *Lingua* 111:465-514.
- Chomsky, Noam. 1995. *The Minimalist Program*. Cambridge, MA: MIT Press.
- Den Dikken, Marcel. 1995. *Particles: On the syntax of verb-particle, triadic, and causative constructions*. New York: Oxford University Press.
- Den Dikken, Marcel. 2003. 'On the syntax of locative and directional adpositional phrases', Ms. City University of New York.
- É. Kiss, Katalin. 2002. *The Syntax of Hungarian*. Cambridge: CUP.
- Emonds, Joseph. 1976. *A Transformational Approach to English Syntax*. New York: Academic Press.
- Emonds, Joseph. 1985. *A unified theory of syntactic categories*. Dordrecht: Foris.
- Fillmore, Charles. 1968. 'The Case for Case'. *Universals in Linguistic Theory*. eds. Emmon Bach and Robert T. Harms. New York: Holt, Rinehart and Winston.
- Gehrke, Berit. 2006. 'On directional readings of locative prepositions', *Proceedings of ConSOLE XIV*.
- Gehrke, Berit. to appear. 'Goals and sources are aspectually equal: Evidence from Czech and Russian prefixes', *Lingua*.
- Halle, Morris, and Marantz, Alec. 1993. 'Distributed Morphology and the Pieces of Inflection', *The view from building 20*. eds. Kenneth Hale and Samuel Jay Keyser. Cambridge, MA: MIT Press.
- Hegedűs, Veronika. 2005. 'Extended Projections - extended analogues: a note on Hungarian PPs', *Organizing Grammar: Linguistic Studies in Honor of Henk van Riemsdijk*. eds. Hans Broekhuis, Norbert Corver, Riny Huybregts, Ursula Kleinheinz and Jan Koster, 197-205. Berlin: Mouton de Gruyter.
- Helmantel, Marjon. 2002. *Interactions in the Dutch adpositional domain*. LOT Dissertation Series.
- Jackendoff, Ray. 1973. 'The Base Rules for Prepositional Phrases', *A Festschrift for Morris Halle*. eds. S. Anderson and Paul Kiparsky, 345-356. New York: Holt, Rinehart and Winston.
- Koopman, Hilda. 2000. 'Prepositions, Postpositions, Circumpositions and Particles' *The Syntax of Specifiers and Heads*. ed. Hilda Koopman, 204-60. London: Routledge.
- Kracht, Marcus. 2002. 'On the semantics of locatives', *Linguistics and Philosophy* 25:157-232.
- Marác, László. 1989. *Asymmetries in Hungarian*. Doctoral Dissertation Rijksuniversiteit Groningen.

- Marantz, Alec. 1997. 'No Escape From Syntax: Don't Try Morphological Analysis in the Privacy of Your Own Lexicon', *Proceedings of the 21st Penn Linguistics Colloquium*.
- Matushansky, Ora. 2002. 'On Formal Identity of Russian Prefixes and Prepositions', *MIT Working Papers in Linguistics* 42:217-53.
- Nikanne, Urpo. 1991. *Zones and Tiers: A Study of Thematic Structure*. Doctoral Dissertation, University of Helsinki.
- Riemsdijk, Henk van. 1978. *A case study in syntactic markedness: the binding nature of prepositional phrases*. Doctoral Dissertation.
- Riemsdijk, Henk van. 1990. 'Functional Prepositions', *Unity in Diversity: Papers Presented to Simon C Dik on his 50th Birthday*. eds. Harm Pinkster and Inge Genee. Dordrecht: Foris.
- Riemsdijk, Henk van, and Huybregts, Riny. 2001. 'Location and Locality', *Progress in Grammar*. eds. Marc van Oostendorp and Elena Anagnostopoulou, 1-23. Utrecht and Meertens Institute Amsterdam: Roccade.
- Svenonius, Peter. 2004. 'Spatial P in English', Ms. Tromsø University.
- Vogel, Ralf, and Steinbach, Markus. 1998. 'The Dative - an Oblique Case', *Linguistische Berichte* 173:65-90.
- Zeller, Jochen. 2001. 'Lexical particles, semi-lexical postpositions' *Semi-Lexical Categories*. eds. Norbert Corver and Henk van Riemsdijk, 505-49. Berlin: Mouton.

# Prosodically-conditioned Sibilant Voicing in Balkan Judeo-Spanish\*

Travis G. Bradley  
UC Davis

## 1. Introduction

Much work in the recent phonetics-phonology interface literature argues that the low-level phonetic realization of words is influenced by higher-order prosodic structure. For instance, articulatory gestures located at prosodic boundaries “get longer, larger, and farther apart” (Byrd and Saltzman 2003: 159, *inter alia*). The degree of edge-adjacent effects correlates with the strength of the prosodic boundary. Researchers have also argued that *phonetic underspecification* provides a descriptively adequate approach to patterns of obstruent voicing neutralization (Ernestus 2003, Hsu 1996, Steriade 1999). In this approach, non-contrastive obstruents are marked by the phonology as neutral, or [0voice], and remain that way into the phonetics, where they are subject to gradient and variable voicing as a function of prosodic context.

In this paper, I show that phonetic underspecification provides a natural account of prosodically-conditioned sibilant voicing in Balkan dialects of Judeo-Spanish (henceforth, JS). A quantitative analysis of corpus data from Crews (1935) indicates that word-final prevocalic sibilant voicing varies across different prosodic contexts, with lower rates of voicing observed before stronger boundaries. I develop an account in Optimality Theory (Prince and Smolensky 1993/2004) of the phonological distribution of sibilant voicing categories. The phonetic implementation of word-final [0voice] sibilants is modeled in Articulatory Phonology using prosodic, or  $\pi$ -gestures, which produce greater slowing of oral constriction gestures across stronger prosodic boundaries (Byrd and Saltzman 2003). Longer sibilant duration favors aerodynamically driven devoicing, which explains the negative correlation between voicing rates and boundary strength.

This paper is organized as follows. Section 2 describes sibilant voicing patterns in JS. Section 3 presents a study of word-final prevocalic sibilant voicing based on Crews (1935). Section 4 develops a phonological and phonetic account of the observed patterns. Section 5 summarizes and concludes.



## 2. Sibilant Voicing Contrast and Neutralization in JS

Modern JS exhibits a phonological contrast between voiceless and voiced sibilants in word-medial intervocalic position, but neutralizes the contrast elsewhere (Penny 1992, 1993: 80-81, 2000: 181-182, 185-186, Sala 1971). The following data exemplify the pattern on the basis of dental sibilants.<sup>1</sup>

- |     |    |             |           |                |             |
|-----|----|-------------|-----------|----------------|-------------|
| (1) |    | aβrasar     | ‘to hug’  | aβrazar        | ‘to scorch’ |
|     |    | pasar       | ‘to pass’ | pazar          | ‘bazaar’    |
| (2) | a. | sapatu      | *zapatu   | ‘shoe’         |             |
|     |    | sodru       | *zodru    | ‘deaf’         |             |
|     | b. | alsar       | *alzar    | ‘to raise’     |             |
|     |    | kansar      | *kanzar   | ‘to fatigue’   |             |
| (3) |    | maz o menos |           | ‘more or less’ |             |
|     |    | doz o tres  |           | ‘two or three’ |             |

In syllable-initial position, both word-initially (2a) and after a heterosyllabic consonant (2b), only the voiceless [s] appears. Sala (1971: 142-143) observes that in Bucharest JS, [z] is limited to intervocalic position in words inherited from Spanish, while [z] appears in initial position only in words borrowed from Hebrew or Turkish. In word-final position, /s/ and /z/ are neutralized to [z] before a following vowel-initial word and to [s] before pause, as shown in (3). (Regressive voicing assimilation applies in preconsonantal contexts, not discussed here.) Penny (1992, 1993: 80-81, 2000: 182) views word-final prevocalic voicing as a similarity that JS shares with modern varieties of Catalan, Portuguese, and by extension, Old Spanish.

Bradley and Delforge (2006a) examine patterns of sibilant voicing in modern JS based on experimental data elicited from a multilingual, elderly female speaker residing in Istanbul. Results indicate that the contrast between voiced and voiceless sibilants is maintained word-internally but that voicing in word-final prevocalic position is more variable than has been indicated in previous descriptions of JS. Acoustic analysis of data from a text reading task shows that 73% of word-final prevocalic sibilants show some degree of phonetic voicing, which generally supports the descriptive observations of Penny (1992, 1993). However, the results also suggest that voicing in this context should be described as a variable process rather than as a categorical phenomenon. Evidence of variability comes from a sentence reading task in which carrier phrases present word-final prevocalic sibilants in different syntactic contexts, as in (4). (Note that word-final sibilants are represented as orthographic <s> regardless of their phonetic realization.)

- (4)
- |    |                    |                            |                     |
|----|--------------------|----------------------------|---------------------|
|    |                    | <i>Diga ___ por favor.</i> | ‘Say ___ please.’   |
| a. | Determiner + Noun  | <i>las amigas</i>          | ‘the friends’       |
| b. | Noun + Adjective   | <i>flores hermosas</i>     | ‘beautiful flowers’ |
| c. | Verb + Adverb      | <i>estamos aki</i>         | ‘we are here’       |
| d. | Noun + Conj + Noun | <i>diyas i semanas</i>     | ‘days and weeks’    |

As shown in Table 1, rates of sibilant voicing differ across syntactic boundary types, following the hierarchy Det + N > N + Adj > V + Adv > N + Conj + N. Fully voiced realizations are favored in the Det + N context (54.8%), and voiceless realizations are most frequent in the N + Conj + N context (84.6%).

	Det + N	N + Adj	V + Adv	N + Conj + N
Voiceless	15 (35.7%)	17 (42.5%)	22 (52.4%)	33 (84.6%)
Partially voiced	4 (9.5%)	9 (22.5%)	9 (21.4%)	1 (2.6%)
Fully voiced	23 (54.8%)	14 (35%)	11 (26.2%)	5 (12.8%)
TOTALS	42 (100%)	40 (100%)	42 (100%)	39 (100%)

Table 1: Word-final prevocalic sibilants by syntactic context:

$$\chi^2 \text{ (df 6, n 163) = 30.02, } p < 0.005$$

### 3. A Corpus-based Study of Sibilant Voicing in Balkan JS

#### 3.1 Hypothesis, method, and data collection

An alternative hypothesis is that word-final prevocalic sibilant voicing is dependent not on syntactic structure but on prosodic boundaries. It is generally agreed that syntax has a non-isomorphic relationship to prosodic structure (Nespor and Vogel 1986, Selkirk 1984, 1996, Zec and Inkelas 1990). Syntactic structure determines prosodic structure, but the two are not identical. I assume that prosodic structure above the foot level is constructed in accordance with the Prosodic Hierarchy in (5).

- (5)
- |                          |  |
|--------------------------|--|
| Utterance (U)            |  |
| Intonational Phrase (IP) |  |
| Phonological Phrase (PP) |  |
| Prosodic Word (PW)       |  |

Languages build prosodic structure in systematic ways, and phonological processes are often restricted to apply within a particular prosodic domain or at the juncture between domains. Recent studies have shown that the low-level

phonetic realization of words is influenced by higher-order prosodic structure, such as the presence of phrase boundaries. In particular, articulatory gestures are known to increase in both duration and magnitude according to the strength of an adjacent prosodic boundary (Beckman et al. 1992, Byrd 2000, Byrd and Saltzman 1998, 2003, *inter alia*). Since longer constriction duration favors sibilant devoicing (Kirchner 1998, Widdison 1997), it is plausible that the distribution of voiced and voiceless sibilants in word-final prevocalic contexts might vary according to prosodic boundary strength. The present study explores the following hypothesis:

- (6) Hypothesis: The rate of word-final prevocalic sibilant voicing decreases as the strength of the intervening prosodic boundary increases.

In order to test this hypothesis on a larger data set, tokens were drawn from Crews's (1935) corpus of phonetically transcribed oral narratives produced in the early 1900s by 11 native speakers of JS residing in Bucharest, Romania and in Bitola and Skopje of what is now the Former Yugoslav Republic of Macedonia. The speakers included three males and eight females, ranging from 13 to 75 years in age. The advantage of using Crews's transcriptions is that they constitute a speech sample of JS prior to its classification as a dying language, at a time when proficient speakers were greater in number. (See Crews 1935: 9-14 for specific details about the informants.)

All tokens of word-final prevocalic sibilants were identified in the corpus and classified according to four prosodic contexts, illustrated by the examples in (7) and (8). Crews's segmental transcriptions are adapted here to standard IPA.

- (7) a. i luz intʃo lus kantarikus  
'and she filled up the little jugs'  
b. porke ti βaz a jir?  
'why are you going to go?'  
c. i li stan kajendu las karnis a piðasus  
'and pieces of his skin are falling off'  
d. «im pas ki tornis.» i se fwe.  
'«May you return in peace.» And she left.'
- (8) a. (luz (intʃo))<sub>PW</sub> PW-internal  
b. (ti (βaz))<sub>PW</sub> (a (jir))<sub>PW</sub> Inflected verb + a + infinitive  
c. (las (karnis))<sub>PW</sub> (a (piðasus))<sub>PW</sub> Across PW boundary  
d. (im pas ki tornis)<sub>MajP</sub> (i se fwe)<sub>MajP</sub> Across a MajP boundary

An unstressed function word was analyzed as a proclitic that adjoins to the following PW to form an outer PW. Such proclitics included determiners,

pronouns, and prepositions, as seen in (8a-c).<sup>2</sup> In (8a), the sibilant-vowel sequence is internal to the outer PW domain. In both (8b,c), the sequence spans across two distinct PWs, where the word containing the sibilant is stressable, but the following vowel-initial word need not be. Based on previous informal observations of frequent sibilant voicing in periphrastic future forms, (8b) was treated as a category separate from (8c). In (8d), ‘Major Phrase’ is a cover term subsuming Phonological Phrase, Intonation Phrase, and Utterance.<sup>3</sup>

### 3.2 Results

The corpus provided a total of 1427 tokens of word-final prevocalic sibilants. Tokens were categorized as either voiced or voiceless, and the rate of voicing was calculated for each of the four prosodic contexts. Table 2 gives frequency counts by geographic region. According to the totals for all 11 subjects combined, [z] appears most often within the PW and in periphrastic future forms, with a combined frequency of 98.6%. In contrast, [s] appears most often across major prosodic boundaries at a rate of 96%. Sibilant voicing is more variable across PW boundaries, with [z] appearing more often than [s] (62% versus 38%). In the texts representing Bitola and Skopje, voiced sibilants are more than two times as frequent as voiceless ones in the PW boundary context, while the difference is negligible for Bucharest.

		PW-internal		V + a + Inf		Across PW		Across MajP	
Bucharest	[s]	6%	4/64	4%	1/25	53%	72/135	96%	66/69
	[z]	94%	60/64	96%	24/25	47%	63/135	4%	3/69
Bitola	[s]	3%	2/59	0%	0/99	36%	91/250	95%	151/159
	[z]	97%	57/59	100%	99/99	64%	159/250	5%	8/159
Skopje	[s]	0%	0/58	0%	0/115	31%	84/267	97%	122/126
	[z]	100%	58/58	100%	115/115	69%	183/267	3%	4/126
TOTALS	[s]	3%	5/181	0%	1/240	38%	247/652	96%	339/354
	[z]	97%	176/181	100%	239/240	62%	405/652	4%	15/354

Table 2: Distribution of word-final prevocalic sibilant allophones (n=1427)

The prosodic structures in (8b,c) predict similar voicing rates for the periphrastic future and the PW boundary contexts. The fact that periphrastic future forms pattern instead with PW-internal contexts suggests that forms like (8b) may have been prosodically restructured: ((ti (βaz)) a)<sub>PW</sub> (jir)<sub>PW</sub>. If the preposition *a* of the periphrastic future patterns as an enclitic to the preceding inflected verb, then the following generalization can be maintained: word-final

prevocalic sibilant voicing is bound to the PW domain. In contrast, voicing is more variable across PW boundaries and virtually absent across major boundaries. These results confirm the hypothesis in (6): sibilant voicing rates decrease as the strength of the intervening prosodic boundary increases.

## 4. Formal Analysis

### 4.1 Sibilant voicing contrast and neutralization

In approaches to obstruent voicing neutralization that assume phonetic underspecification, a distinction is posited between obstruents that are specified as either [+voice] or [-voice] in the input and output of the phonological component and others that are completely unspecified, or neutral, with regard to voicing, represented as [0voice] (Bradley 2005, Bradley and Delforge 2006a,b, Ernestus 2003, Hsu 1996, Steriade 1999). Phonologically voiced or voiceless obstruents require specific articulatory gestures designed to ensure that they will be perceived in accordance with their underlying voicing specification. The production of voiced obstruents always involves a reasonable degree of articulatory effort, and the realization of voiceless obstruents also necessitates specific glottal adjustments when these sounds are adjacent to sonorants. Neutral obstruents, conversely, do not have perceptual targets and do not entail any specific articulatory gestures. They are marked as [0voice] by the grammar and remain unspecified into the phonetic implementation component (hence the term *phonetic underspecification*). Such sounds adopt the laryngeal configurations of contiguous sounds and can therefore be expected to exhibit gradient and variable voicing as a result of the interpolation of contextual glottal activity.

Patterns of sibilant voicing neutralization can be analyzed as the interaction of faithfulness and markedness constraints within Optimality Theory (henceforth, OT; Prince and Smolensky 1993/2004). I assume the constraints shown in (9). (For other work on Ibero-Romance sibilant voicing in OT, see Bermúdez-Otero 2001, Bradley 2005, Bradley and Delforge 2006b, Colina 2006.)

- (9)
- a. MAXSIB(voi/V\_V) Let SIB be an intervocalic output sibilant. A [voice] feature in the input correspondent of SIB has an output correspondent in SIB.
  - b. MAXSIB(voi) Let SIB be an output sibilant. A [voice] feature in the input correspondent of SIB has an output correspondent in SIB.
  - c.  $\sigma$ [s A sibilant in syllable-initial position is [-voice].
  - d. \* $[\alpha$ voi No obstruent has a [voice] feature.
  - e. MAXSIB(voi/V\_V) »  $\sigma$ [s » \* $[\alpha$ voi » MAXSIB(voi)

The MAXSIB(voi) constraints in (9a,b) ensure that sibilant voicing specifications in the input are realized faithfully in the output. (9a) is relativized to intervocalic position, while (9b) is a context-free constraint. The positional markedness constraint in (9c) requires sibilants in syllable-initial position to be voiceless. Context-free (9d) assigns one violation per positive or negative voicing specification, thereby favoring [0voice] sibilants in the output. The ranking in (9e) accounts for sibilant voicing patterns in Balkan JS. Generally speaking, output sibilants are phonetically underspecified for voicing with two exceptions: (i) [s] occurs in syllable-initial position, and (ii) [z] contrasts with [s] in syllable-initial position between vowels.

The analysis of word-medial intervocalic sibilants is shown in tableau (10). In output candidates, periods indicate syllable boundaries, with syllabification determined by constraints not shown here. Uppercase [S] in (c,f) denotes a sibilant that is neutral in [voice]. High-ranking MAXSIB(voi/V\_V) maintains input voicing specifications when sibilants appear between vowels in the output. The optimal candidates (a) and (d) correspond to examples such as the minimal pairs shown in (1).

(10) Maintenance of sibilant [voice] contrast word-medially between vowels<sup>4</sup>

	MAXSIB(voi/V_V)	$\sigma$ [s]	*[ $\alpha$ voi]	MAXSIB(voi)
☞ a. /VsV/ V.sV			*	
b. V.zV	*!	*	*	*
c. V.SV	*!	*		*
☞ d. /VzV/ V.zV		*	*	
e. V.sV	*!		*	*
f. V.SV	*!	*		*

The same ranking produces neutralization to [s] in word-initial and syllable-initial postconsonantal contexts. Since MAXSIB(voi/V\_V) is irrelevant in non-intervocalic position, the next lowest constraint  $\sigma$ [s] would map potential inputs such as /sapatu/ and hypothetical /zapatu/ to [sapatu] ‘shoe’ (2).

In syllable-final position, both MAXSIB(voi/V\_V) and  $\sigma$ [s] are irrelevant. In tableau (11), lower-ranked \*[ $\alpha$ voi] eliminates candidates (a,b) and (d,e) because they have sibilants that are phonologically specified for [voice]. The result is neutralization to [0voice] in (c) and (f).

## (11) Neutralization to [0voice] in syllable codas

	MAXSIB(voi/V_V)	$\sigma$ [s]	*[ $\alpha$ voi]	MAXSIB(voi)
a. /Vs/ Vs.			*!	
b. Vz.			*!	*
☞ c. VS.				*
d. /Vz/ Vz.			*!	
e. Vs.			*!	*
☞ f. VS.				*

In analyzing the phrasal behavior of word-final sibilants, I assume a distinction between lexical and postlexical rankings in OT (Itô and Mester 2001, Kiparsky 1998, and McCarthy and Prince 1993, *inter alia*). While Richness of The Base holds of inputs to the lexical phonology, the input to the postlexical phonology is necessarily the output of the lexical phonology. Candidates (11c,f) show that word-final sibilants are [0voice] in lexical outputs: [VS]. Let us assume /VS#V/ as the postlexical input representing the context of a word-final prevocalic sibilant. Since input /S/ has no [voice] specification, the MAXSIB(voi) constraints are irrelevant.  $\sigma$ [s] incorrectly generates a [-voice] sibilant in this context—contrary to the variation observed in Table 2. Following Colina (2006) and Ernestus (2003), I solve this problem with the constraint in (12), which forbids the insertion of [voice] features in the output.<sup>5</sup>

## (12) DEPSIB(voi)

Let SIB be an input sibilant. A [voice] feature in the output correspondent of SIB has an input correspondent in SIB.

When added above  $\sigma$ [s] in the postlexical ranking, DEPSIB(voi) correctly maintains the neutral word-final sibilant when it becomes prevocalic at the phrase level:

## (13) Neutral sibilant maintained word-finally before vowels

/VS#V/	DEPSIB(voi)	MAXSIB (voi/V_V)	$\sigma$ [s]	*[ $\alpha$ voi]	MAXSIB(voi)
☞ a. V.SV			*		
b. V.sV	*!			*	
c. V.zV	*!		*	*	

## 4.2 Phonetic implementation

Figure 1 compares the phonetic implementation of sibilant voicing in three scenarios: a neutral sibilant of relatively short duration (a), a neutral sibilant of

longer duration (b), and a sibilant that is phonologically specified as [-voice] (c). Solid horizontal lines denote glottal targets corresponding to phonologically specified [voice] features, and dotted lines show interpolation between targets. Since the [0voice] sibilants have no specified target, glottal vibration is determined by gradient interpolation from the surrounding vowels. Sibilants whose constriction duration extends beyond certain thresholds tend to passively devoice for aerodynamic reasons, and voiceless fricatives are typically longer than voiced ones (Kirchner 1998: 163, 236, Widdison 1997). Shorter constriction durations in (a) increase the probability of complete voicing throughout neutral [S], whereas longer durations in (b) favor gradient degrees of voicelessness. In contrast, the intervocalic [s] in (c) has a phonologically specified [-voice] target. Interpolation from the first vowel to the sibilant and from the sibilant to the second vowel produces only transitional glottal vibration at the margins of the sibilant constriction.

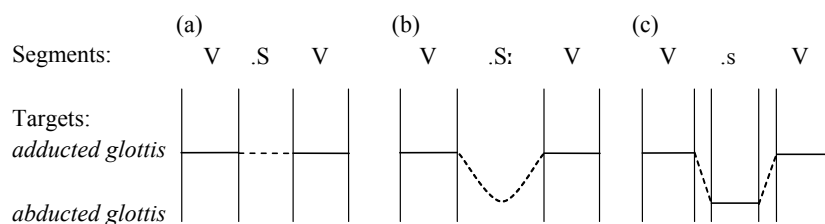

Figure 1: Sibilant voicing as interpolation between phonetic targets

In Articulatory Phonology, gestures are dynamically, spatio-temporally defined articulatory movements that produce a constriction in the vocal tract (Browman and Goldstein 1989, 1990, 1991, 1992). Articulatory gestures are known to increase in both duration and magnitude according to the strength of an adjacent prosodic boundary (Beckman et al. 1992, Byrd 2000, Byrd and Saltzman 1998, 2003, inter alia). Byrd and Saltzman (2003) propose to model boundary-adjacent lengthening and strengthening effects by way of prosodic, or  $\pi$ -gestures, which slow the timeflow of oral constriction gestures at phrasal junctures. The magnitude of the  $\pi$ -gesture correlates with prosodic boundary strength, such that stronger boundaries favor longer sibilant constriction gestures and, therefore, lower rates of sibilant voicing.

The PW-internal context is illustrated by the gestural score in Figure 2. Higher-order prosodic structure is indicated on the first tier. Prosodic and oral gestures are shown on the second and third tiers, respectively. On the oral tier, the broken lines represent the tongue body gestures of the surrounding vowels, and the solid line represents the tongue tip gesture of [S]. The fourth and final tier shows the state of the vocal folds, where the jagged line represents vibration. On the assumption that no  $\pi$ -gestures are present within the PW domain, the sibilant



constriction does not undergo boundary-adjacent lengthening. The lack of a glottal target allows continuous vocal fold vibration throughout the shorter sibilant. This accounts for the categorical nature of sibilant voicing within PWs.

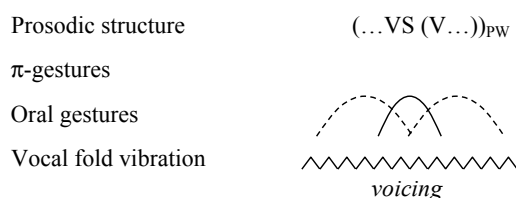

Figure 2: Lack of  $\pi$ -gesture within the PW favors sibilant voicing

Figure 3 compares word-final prevocalic [S] in the PW and major prosodic boundary contexts. Centered, by hypothesis, on the intersection of gestures for [S] and the following vowel, the  $\pi$ -gesture has the effect of slowing down the sibilant and vowel gestures with which it overlaps. Slower movement of the articulators lengthens the sibilant-vowel sequence, which favors greater degrees of aerodynamically driven sibilant devoicing. In the PW boundary context (a), the broken, jagged line on the final tier represents the greater susceptibility of vocal fold vibration to cease at some point during the longer sibilant constriction. The increased magnitude of the  $\pi$ -gesture appearing in the major boundary context further lengthens the sibilant constriction. Passive devoicing is even more likely, as indicated by the broken, straight line on the final tier.

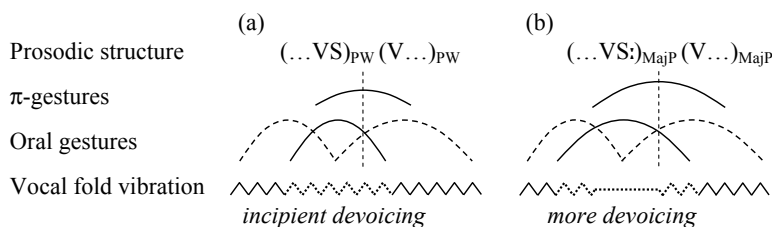

Figure 3: Variation in  $\pi$ -gesture strength produces longer sibilant duration and greater degrees of devoicing across higher prosodic boundaries

## 5. Conclusion

In the Balkan JS corpus data examined here, word-final prevocalic sibilants are less likely to be realized as voiced across stronger prosodic boundaries. By making explicit the relationship between prosodic structure and low-level phonetic implementation, the proposed analysis offers an integrated account of

variability in JS sibilant voicing. Based on modern Catalan, Portuguese, and JS, Penny (1993: 80-81) hypothesizes that word-final prevocalic sibilant voicing also existed in medieval Castilian Spanish. If future research on Catalan and Portuguese were to corroborate the results of the present study, then it seems reasonable to assume that speakers of medieval Castilian would have shown similar patterns of variability in the realization of word-final sibilants.

## Notes

\* For comments on an oral presentation of this work, I acknowledge the audience members of the 2006 Western Conference on Linguistics, held at the California State University, Fresno in October 2006. Thanks to Ann Marie Delforge for assistance with the corpus frequency data. This research was partially supported by funding from a Small Grant in Aid of Research, “Variation and Change in the Sound System of Judeo-Spanish” (Academic Senate, UC Davis).

<sup>1</sup> Here I examine only the dentals /s/ and /z/. JS also has voiced and voiceless prepalatal fricatives, /ʃ/ and /ʒ/, which do not appear word-finally except in borrowings from Hebrew, Turkish, and French (Sala 1971: 144-146).

<sup>2</sup> Alternatively, unstressed function words can be included directly in the prosodic word domain of a following word, without the recursive structure (see Hualde, to appear). See Quilis (1988: 314-318) for a complete list of stressable and unstressable words in Spanish.

<sup>3</sup> Since intonation and durational cues are not recoverable from Crews’s phonetic transcriptions, it is not possible to know for sure how subjects prosodified a given utterance. Here, ‘Major Phrase’ included word-final prevocalic sibilants followed either by some punctuation mark, as in (8d), or by the coordinating conjunctions *i* ‘and’ and *o* ‘or’ without intervening punctuation.

<sup>4</sup> MAXSIB(voi/V\_V) overgenerates a three-way surface contrast by mapping the potential input /VSV/ faithfully to the output [V.SV]. Overgeneration is not a problem in frameworks that assume constraints governing the perceptual distinctiveness of surface contrasts. In the intervocalic context, the interpolation of voicing from the surrounding vowels would produce a form that is perceptually too similar to a [+voice] sibilant between vowels. Inviolable contrast constraints effectively rule out such a contrast (see Bradley 2005 and Bradley and Delforge 2006b for further discussion).

<sup>5</sup> For an alternative account based on postlexical contrast preservation in Dispersion Theory, see Bradley (2005) and Bradley and Delforge (2006b). For a critique of this approach, see Colina (2006).

## References

- Beckman, Mary E., Jan Edwards and Janet Fletcher. 1992. “Prosodic Structure and Tempo in a Sonority Model of Articulatory Dynamics”, *Papers in Laboratory Phonology II: Gesture, Segment, Prosody*, Gerard J. Docherty and D. Robert Ladd (eds.), 68-86. Cambridge: Cambridge University.
- Bermúdez Otero, Ricardo. 2001. “Voicing and Continuancy in Catalan: a nonvacuous Duke-of-York Gambit and a Richness-of-the-Base Paradox”, Ms., University of Manchester.
- Bradley, Travis G. 2005. “Sibilant Voicing in Highland Ecuadorian Spanish”, *Lingua(gem)*, 2.2: 9-42.

- Bradley, Travis G., and Ann Marie Delforge. 2006a. "Phonological Retention and Innovation in the Judeo-Spanish of Istanbul", *Selected Proceedings of the 8th Hispanic Linguistics Symposium*, Timothy L. Face and Carol A. Klee (eds.), 73-88. Somerville, MA: Cascadilla Proceedings Project.
- Bradley, Travis G., and Ann Marie Delforge. 2006b. "Systemic Contrast and the Diachrony of Spanish Sibilant Voicing", *Historical Romance Linguistics: Retrospective and Perspectives*, Randall Gess and Deborah Arteaga (eds.), 19-52. Amsterdam: John Benjamins.
- Browman, Catherine and Louis Goldstein. 1989. "Articulatory Gestures as Phonological Units", *Phonology*, **6**: 201-252.
- Browman, Catherine and Louis Goldstein. 1990. "Gestural Specification Using Dynamically Defined Articulatory Structures", *Journal of Phonetics*, **18**: 299-320.
- Browman, Catherine and Louis Goldstein. 1991. "Gestural Structures: Distinctiveness, Phonological Processes, and Historical change", *Modularity and the Motor Theory of Speech Perception*, Ignatius G. Mattingly and Michael Studdert-Kennedy (eds.), 313-338. Hillsdale, NJ: Lawrence Erlbaum.
- Browman, Catherine and Louis Goldstein. 1992. "Articulatory Phonology: An Overview", *Phonetica*, **49**: 155-180.
- Byrd, Dani. 2000. "Articulatory Vowel Lengthening and Coordination at Phrasal Junctures", *Phonetica*, **57**.1: 3-16.
- Byrd, Dani and Elliot Saltzman. 1998. "Intragestural Dynamics of Multiple Phrasal Boundaries", *Journal of Phonetics*, **26**: 173-199.
- Byrd, Dani and Elliot Saltzman. 2003. "The Elastic Phrase: Modeling the Dynamics of Boundary-adjacent Lengthening", *Journal of Phonetics*, **31**: 149-180.
- Colina, Sonia. 2006. "Voicing Assimilation in Ecuadoran Spanish: Evidence for Stratal OT", Paper presented at the *XXXVI Linguistic Symposium on Romance Languages*, Rutgers University, NJ.
- Crews, Cynthia. 1935. *Recherches sur le judéo-espagnol dans les pays balkaniques*. Paris: Droz.
- Ernestus, Mirjam. 2003. "The Role of Phonology and Phonetics in Dutch Voice Assimilation", *The Phonological Spectrum, Volume I: Segmental Structure*, J. van de Weijer, V. J. van Heuven, and H. van der Hulst (eds.), 119-144. Amsterdam: John Benjamins.
- Harris, James. 1983. *Syllable Structure and Stress in Spanish: A Nonlinear Analysis*. Cambridge, MA: MIT Press.
- Hualde, José Ignacio. To appear. "Stress Addition and Stress Removal in Spanish", *Journal of Portuguese Linguistics (special issue on Prosody of Iberian Languages, ed. by G. Elordieta and M. Vigário)*.
- Hsu, Chai-Shune. 1999. "Voicing Underspecification in Taiwanese Word-Final Consonants", *UCLA Working Papers in Linguistics, No. 2: Papers in Phonology 3*, Matthew K. Gordon (ed.), 1-24. Los Angeles, CA: UCLA Department of Linguistics.
- Itô, Junko, and Armin Mester. 2001. "Structure Preservation and Stratal Opacity in German", *Segmental Phonology in Optimality Theory: Constraints and representations*, Linda Lombardi (ed.), 261-295. Cambridge: Cambridge University Press.
- Kiparsky, Paul. 1998. "Paradigm Effects and Opacity", Ms., Stanford University.

- Kirchner, Robert. 1998. *An Effort-based Approach to Consonant Lenition*, Ph.D. dissertation, University of California, Los Angeles.
- McCarthy, John J., and Alan Prince. 1993. "Prosodic Morphology I: Constraint Interaction and Satisfaction", Ms., University of Massachusetts, Amherst, and Rutgers University, New Brunswick, NJ.
- Nespor, Marina and Irene Vogel. 1986. *Prosodic Phonology*. Dordrecht: Foris.
- Penny, Ralph. 1992. "Dialect Contact and Social Networks in Judeo-Spanish", *Romance Philology*, **46.2**: 125-140.
- Penny, Ralph. 1993. "Neutralization of Voice in Spanish and the Outcome of the Old Spanish Sibilants: A Case of Phonological Change Rooted in Morphology", *Hispanic Linguistic Studies in Honour of F. W. Hodcroft*, David Mackenzie and Ian Michael (eds.), 75-88. Oxford: Dolphin.
- Penny, Ralph. 2000. *Variation and Change in Spanish*. Cambridge: Cambridge University, 2000.
- Prince, Alan, and Paul Smolensky. 1993/2004. *Optimality Theory: Constraint interaction in generative grammar*, Technical Report, Rutgers University and University of Colorado at Boulder, 1993. Revised version published by Blackwell, 2004.
- Quilis, Antonio. 1988. *Fonética acústica de la lengua española*. Madrid: Editorial Gredos.
- Sala, Marius. 1971. *Phonétique et phonologie du judéo-espagnol de Bucarest*. The Hague: Mouton.
- Selkirk, Elizabeth. 1984. *Phonology and Syntax: The Relation between Sound and Structure*. Cambridge, MA: MIT Press.
- Selkirk, Elizabeth. 1996. "Sentence Prosody: Intonation, Stress, and Phrasing", *Handbook of Phonological Theory*, John A. Goldsmith (ed.), 550-569. London: Blackwell.
- Steriade, Donca. 1999. "Phonetics in Phonology: The Case of Laryngeal Neutralization", *UCLA Working Papers in Linguistics, No. 2: Papers in Phonology 3*, Matthew Gordon (ed.), 25-146. Los Angeles, CA: UCLA Department of Linguistics.
- Widdison, Kirk. 1997. "Phonetic Explanations for Sibilant Patterns in Spanish", *Lingua* **102**: 253-264.
- Zec, Draga and Sharon Inkelas. 1990. "Prosodically Constrained Syntax", *The Phonology Syntax Connection*, Sharon Inkelas and Draga Zec (eds.), 365-378. Chicago: University of Chicago Press.

Travis G. Bradley  
 Department of Spanish and Classics  
 University of California, Davis  
 One Shields Ave.  
 Davis, CA 95616  
 tgbradley@ucdavis.edu

# The Perfect and the Implication of Counterfactuality: the Case of Rukai<sup>1</sup>

**Cheng-Fu Chen**

University of Texas at Austin

## 1 Introduction

It has been proposed by Iatridou (2000) that morphology is responsible for an interpretation of counterfactuality, which is realized by the past tense in a variety of typologically different languages. Specifically, the past tense is associated with the Exclusion Feature. A relation of exclusion is encoded in the domain of time such that the utterance time, or speech time, is excluded from the topic time, or reference time; in terms of the domain of worlds, the actual world is excluded from the topic worlds. By building on Iatridou's (2000) analysis, this paper discusses the case of Rukai. An examination of the semantic and morphosyntactic levels suggests that, as Rukai does not have a genuine past tense, the perfect morpheme is used to convey the meanings of past and counterfactuality.

## 2 Preliminaries and the Data

Rukai is a Formosan (Austronesian) language spoken in the southern and southeastern parts of Taiwan. It exhibits a great deal of variation in phonology, morphology and syntax among its six dialects, Budai, Tanan, Labuan, Mantauran, Maga and Tona (Li 1996, 1997). In this paper I investigate Budai Rukai and follow Zeitoun et al. (1996) (cf. Li 1973) to treat Nonfuture and Future as two morphologically realized tenses in this language, although I have different assumptions with regard to how they are realized.<sup>2</sup>

In a Rukai simple finite sentence, the verb is required to bear tense morphology, either the Nonfuture tense (*wa-*, *ma-*, *-a-*, and  $\emptyset$  (zero morpheme)), or the Future tense (*(lr)i-*). The alternation of the two sets of morphemes allows a situation to be located in a proper time frame in the past or present, or in the future. Consider (1a-b).

- (1) a. **Wa**-pacas-aku.  
 NFUT-write-1S.N<sup>3</sup>  
 ‘I wrote/write/am writing.’  
 b. **(Lr)i**-pacase-(a)ku.  
 FUT-write-1S.N  
 ‘I will write.’

A simple sentence marked with the Nonfuture tense such as (1a) is associated with Neutral aspect (Smith 1997), which allows a past, present (including a habitual or generic interpretation), or ongoing reading, depending on the situation types and intrinsic bounds that are involved.<sup>4</sup> The examples in (2) show that sentences with different situation types can be interpreted accordingly: States have either a past or present reading in (2a); Activities convey a past, present or ongoing situation in (2b); Accomplishments in (2c), Achievements in (2d) and Semelfactives in (2e) basically convey a past situation. It can be seen that the Rukai Nonfuture tense is underspecified for past or present; the temporal interpretation of a simple sentence in Nonfuture can depend largely on the situation type.

- (2) a. **Ma**-duli ka bengelai. (State)  
 NFUT-red NOM flower  
 ‘The flower was/is red.’  
 b. **Wa**-tamaku kai agi-li. (Activity)  
 NFUT-smoke DEM brother-1S.G  
 ‘My brother smoked/smokes/is smoking.’  
 c. **Wa**-pacas ku hung kudra Baleng. (Accomplishment)  
 NFUT-write ACC book DEM Baleng  
 ‘Baleng wrote a book.’  
 d. **Wa**-mua-ku Vudai. (Achievement)  
 NFUT-go-1S.N Vudai  
 ‘I went to Vudai.’  
 e. Pa-Ø-rulu kudra lasu. (Semelfactive)  
 -NFUT-cough DEM guy  
 ‘That guy coughed.’

### 3 Temporal and Aspectual Interpretations of the Perfect

The morpheme *na-* participates in temporal and aspectual interpretations of sentences. In this section I will discuss these interpretations by assuming that *na-* is a Perfect morpheme as a working hypothesis.

Perfect *na-* applies to states and events. As we have seen that States and Activities in the Nonfuture allow a past or present interpretation, only the past

reading survives when they are additionally marked by *na-*. Contrast (3a-b).

- (3) a. **Ma**-barenger-ako ki na.  
 NFUT-miss-1S.N OBL mom  
 ‘I missed/miss mom.’  
 b. **Na**-ma-barenger-ako ki ina.  
 PFT-NFUT-miss-1S.N OBL mom  
 (i) ‘I (had) missed mom.’  
 (ii) ≠ ‘I miss mom.’

*Na-* co-occurs with Future (*lr*)-, but the sentence conveys counterfactuality in (4a), an issue that will be discussed in section 4. A reading like English Future Perfect ‘will have’ is conveyed in Rukai by Future and the Perfective suffixal morpheme *-nga* in (4b).

- (4) a. **Na-i**-pacas-aku.  
 PFT-FUT-write-1S.N  
 ‘I would have written (it).’  
 b. **(Lr)i**-pacase-**nga**-(a)ku.  
 FUT-write-PFV-1S.N  
 ‘I will have written (it).’

*Na* is also found to be used as a determiner in DPs, where it attributes a state, property or relation that holds at a past time to an individual. Consider (5a-b) and (6a-b). It seems that *na* can be used like English *ex-*, or *former*, but we will not discuss this use in this paper.

- (5) topic-comment  
 a. [Kai Asiane], [ka labaibai-li]  
 DEM NOM wife-1S.G  
 ‘Asiane, she is my wife.’  
 b. [Kai e], [**na** nakuane].  
 DEM DET(PFT) 1S.O  
 ‘That (thing) was mine.’  
 (6) predicate-subject  
 a. [Ka labaibai-li] [ka Asiane]  
 DET wife-1S.G NOM  
 ‘Asiane is my wife.’  
 b. [**Na** labaibai-li] [ka Asiane].  
 DET(PFT) wife-1S.G NOM  
 ‘Asiane was my wife/is my ex-wife.’

### 3.1 The past meaning and the perfective aspect

The Nonfuture and Nonfuture Perfect both select temporal adverbials that are past-oriented, such as ‘yesterday’ or ‘three days ago’, as in (7a-b).

- (7) a. *Wa-mua-ako Vudai {ku iya/ sa maka-dulrulru}*.  
 NFUT-go-1S.N Vudai DET day/ when MAKA-three/RED  
 ‘I went to Vudai {yesterday/three days ago}.’
- b. *Na-wa-mua-ako Vudai {ku iya/ sa maka-dulrulru}*.  
 PFT-NFUT-go-1S.N Vudai DET day/ when MAKA-three/RED  
 ‘Lit. I had been to Vudai {yesterday/three days ago}.’

The Nonfuture Perfect co-occurs with a temporal adverb that has relevance to *today*, only when it denotes a past time relative to the Speech Time (SpT).

- (8) *Ko ina, na-i-a-kai koingi aungu kai miyalrealre.*  
 DET mom PFT-be-NFUT-there park whole DEM morning  
 ‘Mom was/had been in the park the whole morning today.’

Only the Nonfuture is compatible with adverbials that are related to the SpT, such as ‘now’ in (9a). By contrast, the Nonfuture Perfect cannot co-occur with present adverbs, as seen in (9b).

- (9) a. *Wa-mua-ako Vudai kai asasane.*  
 NFUT-go-1S.N Vudai DEM now  
 ‘I am going to Vudai now.’
- b. *\*Na-wa-mua-ako Vudai kai asasane.*  
 PFT-NFUT-go-1S.N Vudai DEM now  
 ‘\*I had been to Vudai now.’

The Nonfuture Perfect is incompatible with a time span which includes the SpT, as shown in (10).

- (10) *Tualai ko icaili pakela {\*kai asasane/ ko mialrealre}, na-i-a-kai-ako Vudai.*  
 from DET year to DEM now DET morning PFT-be-NFUT-there-1S.N Vudai  
 ‘Since last year till {now, this morning} I have been in Vudai.’

The Nonfuture Perfect does not inherit the same temporal underspecification of the Nonfuture tense but specifies a past interpretation in not admitting a current relevance reading like the English Present Perfect (McCoard 1978, Dowty 1979).

In complement clauses introduced by connective *sa* ‘when’, the Perfect expresses eventualities that occurred prior to a contextually established Reference Time (RT) (Reichenbach 1947). As shown in (11), the two events involved in the



two clauses cannot occur concurrently. His brother's singing must have occurred and terminated at some time earlier than the time of Takanau's reading.

- (11) Sa **na**-senai ka agi-(i)ni, wa-bikiu kai hong ka Takanau.  
 when PFT-sing NOM brother-3S.G NFUT-read DEM book NOM Takanau  
 'Lit. After/when his brother had sung, Takanau read this book.'

The viewpoint aspect introduced by *na*- is perfective. Situations are presented as closed and do not continue to the SpT (Lyons 1977, Smith 1997). Contrast (12a-b).

- (12) a. **Na**-ma-duli ka bengelai. (State)  
 PFT-NFUT-red NOM flower  
 'The flower had been red.'  
 b. **Na**-wa-tamaku kai agi-li. (Activity)  
 PFT-NFUT-smoke DEM brother-1S.G  
 'My brother had smoked.'

We can see that the semantics of *na*- involves two components, one about the past and the other the perfective .

### 3.2 The analysis

This paper assumes the TP structural schema of Pancheva and von Stechow (2004) in (13), in which the Perfect is projected above the AspP and below the TP. The assumption is based on that the Perfect has an explicit effect on the event structure (Aktionsart), and syntactically it behaves like an aspectual morpheme rather than a tense marker, as will be discussed in the following subsection.

- (13) [<sub>TP</sub> Tense [<sub>PerfP</sub> Perfect [<sub>AspP</sub> Viewpoint-Aspect [<sub>vP</sub> Aktionsart ]]]]

Based on its temporal and aspectual interpretations, I provide an analysis for the Nonfuture Perfect in (14) and (15).

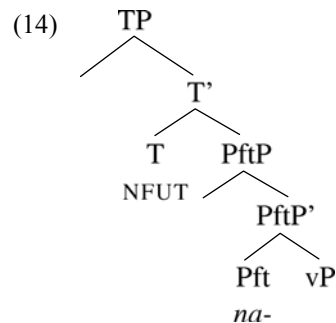

- (15) a. TP:  $\exists t \exists e (E(e) \wedge TERM(e) < t \wedge t \leq SpT)$   
 b. T(NFUT):  $\lambda P \exists t (P(t) \wedge t \leq SpT)$   
 c. PftP:  $\lambda t \exists e (E(e) \wedge TERM(e) < t)$   
 d. **Pft**:  $\lambda P \lambda t \exists e (P(e) \wedge TERM(e) < t)$   
 e. vP:  $\lambda E.E$

By assuming that the Situation Time (SitT) is not directly introduced at the vP level (following Ramchand 2006, cf. Davidson 1967, Parsons 1990, Giorgi and Pianesi 1997), SitT is considered to be implicated in the semantics of the Perfect. *TERM* is a function of coercion operation that maps an eventuality to its termination or completion as an interval, which is in turn located in time (Beaver and Condoravdi 2003). The temporal anterior relation of  $TERM(e) < t$  (similar to *before*, in terms of successive relations) would predict that SitT always precedes RT in simple Nonfuture Perfect sentences. Under this approach, the Nonfuture tense does not specify a past meaning but introduces an existential closure.

Perfects often present result states, such as in ‘He has gone to Hong Kong’. In the case of Rukai, the Perfect always conveys that an eventuality (and the result/consequent state of a telic event) does not obtain at the SpT, as implicated by  $TERM(e) < t$  in (15d). Thus, the Rukai Perfect is very similar to the marker *guo* in Mandarin Chinese (Carlota Smith, p.c.).

The analysis of Rukai Perfect *na-* also explains certain semantic inferences that are involved in discourse. For example, in (16), which asserts that there is a past time at which the state of Takanau’s liking you held, the very same state does not hold at the SpT.

- (16) **Na**-ma-dalame musuane ka Takanau.  
 PFT-NFUT-like 2S.O NOM Takanau  
 Ai kai asasane ma-seleme musuane.  
 but DEM now NFUT-be disappointed-1S.N 2S.O  
 ‘Takanau had liked you. But now he is disappointed at you.’

Example such as (17) can also illustrate the meanings of termination and temporal anteriority that are associated with Perfect *na-*.

- (17) #**Na**-wa-pacai ka Kecelre, ai wa-pacai-ana.  
 PFT-NFUT-die NOM Kecelre but NFUT-die-IMPV  
 ‘Lit. Kecelre had died, but he is still dead.’

The first clause asserts that at a past time Kecelre was in the state of being dead, with the inference that this state does not hold at the SpT; in other words, he was resurrected. The second clause, however, asserts that the state of Kecelre’s being dead still holds at the SpT. These two assertions are contradictory and thus result

in the infelicitous interpretation of this sentence.

Iatridou (2000) offers a cross-linguistic observation and proposes that the past tense morpheme is associated with an Exclusion Feature (ExclF), whose meaning depends on the environment where it is interpreted, either the domain of time or worlds. Iatridou (2000) analyzes ExclF to have the form in (18).

(18)  $T(x)$  excludes  $C(x)$ .

In the domain of time,  $T(x)$ , the topic time, excludes  $C(x)$ , the utterance time, in which  $x$  ranges over times (cf. Klein 1994). Developing on Iatridou (2000), I propose that the exclusion interpretation is associated with *na-* in Rukai, implicated by  $TERM(e) < t$  in its semantics.

### 3.3 Is *na-* Perfect, or Past?

One particular interpretation of the Rukai *na-* morpheme is that when it occurs with a past adverb, this adverb seems to only serve as the SitT (cf. (7b)). Descriptively speaking, the situation under discussion occurs within the provided time span, that is,  $SitT \subseteq RT$ . The same reading is obtained even when the adverb is shifted to other positions. This differs from the English Perfect. Consider the English examples in (19). When an adverb appears in the final position, as in (19a), its interpretation is ambiguous, referring to either RT or SitT. By contrast, an adverb located in the initial position can only denote RT, but not SitT, as exemplified by (19b-c). When the adverb, last Friday, refers to RT, the situation in discussion occurred at some time earlier than last Friday, that is,  $SitT < RT$ .

- (19) a. John had left last Friday (last Friday = RT or SitT)  
 b. Last Friday, John had left (SitT < RT = last Friday)  
 c. Last Friday, John had left 3 days earlier. (SitT < RT = last Friday; SitT = three days earlier than last Friday)

As we have seen that *na-* is associated with the past, and termination or completion in its semantics, we might argue as well that *na-* is actually a past tense, because it simply does not push back the time at which a situation holds relative to the time denoted by a temporal adverb.

The reason for favoring an analysis of *na-* as Perfect instead of Past is syntactic. *Na-* is peculiar in not forming a finite sentence by itself, as seen in (20a); it requires the co-occurrence of the Nonfuture tense in a simple finite sentence, as shown in (20b).

- (20) a. \***Na**-pacas-aku.  
 PFT-write-1S.N

- b. **Na-wa-pacas-aku.**  
 PFT-NFUT-write-1S.N  
 ‘I wrote/had written.’

Besides, *na-* occurs in nonfinite clauses, such as in the complement clauses of the connective *sa* ‘when’, as in (11). The Nonfuture tense is regularly excluded in constructions of this sort.

However, a syntactic property of the structural projection of the tense morphology in negation seems to suggest a different picture for *na-*. In a negative sentence, the negation morpheme is the primary predicate which is generally located in the initial position. *Na-* and the Future morpheme can be exceptionally positioned in front of negation (or after negation), as shown in (21a-b). The Nonfuture morpheme never precedes negation, (21c).<sup>5</sup>

- (21) a. **Na-kai wa-edale.**  
 PFT-NEG NFUT-rain  
 ‘It didn’t rain.’  
 b. **Lri-kai edale.**  
 FUT-NEG rain  
 ‘It won’t rain.’  
 c. **Kai wa-edale. (\*Wa-kai edale.)**  
 NEG NFUT-rain  
 ‘It didn’t rain/it’s not raining.’

Semantically, *na-* is full-fledged in conveying past like a tense, but it does not seem to be a canonical past tense in terms of syntax. In the ongoing research, it serves as a working hypothesis that *na-* is considered as a Perfect morpheme which denotes a semantic past, and in the domain of tense, it is treated as a semantic rather than a syntactic past tense.

In the following section I will discuss *na-* and the meaning of counterfactuality.

## 4 Perfect and the Meaning of Counterfactuality

Perfect *na-* participates in the construction of conditionals in Rukai, both morphologically and semantically, as discussed below.

### 4.1 Future Perfect and implicit conditionals

As we have seen previously, when the Nonfuture co-occurs with the Perfect, the sentences only convey a past interpretation. However, when the Future occurs with the Perfect, it constructs implicit conditionals, which describe a situation that

is counterfactual or unknown to the speaker (cf. Anderson 1951, Karttunen and Peters 1979, and Smith, Perkins and Fernald (In press, to appear 2007)). For example, in (22a-b), the speaker thinks that if certain conditions had been met, it would be probable that Kecelre would have been dead, and the flower would have been red.

- (22) a. **Na-i-pacai** ka Kecelre.  
 PFT-FUT-die NOM Kecelre  
 ‘Kecelre would have died.’  
 b. **Na-i-kaduliduli** ka bengelrai, ai a-icecele.  
 PFT-FUT-red NOM flower but NFUT-black  
 ‘The flower should have been red, but it turned black.’

The inferences for (22a-b) are that, given all the accessible information, Kecelre was not dead, and the flower was never red.

#### 4.2 The Perfect morpheme and conditionals

A set of Rukai conditionals is constructed in form of ‘*If* P, Q’, whose schema of formation is shown in (23).

- (23) a. Present Counterfactual: [*Alaiyasi* VP], [(PFV-)FUT-VP]  
 b. Past Counterfactual: [*Anaiyasi* VP], [(PFV-)FUT-VP]

*Alaiyasi* is used in present counterfactuals, and *anaiyasi* in past counterfactuals.<sup>6</sup> In the current research, it is hypothesized that they are composed by a common root *asi* ‘if’, and *ala* or *ana*, each of which serves as the modal basis of an *if*-clause. VPs in the antecedent clauses are nonfinite, whereas those in the consequent bear tense morphology, *na-i*-(Perfect-Future) or simply Future. Consequent clauses that are marked with the Future Perfect have the same structure as implicit conditionals like (22).

First, let us look at how modal morphemes can be used. Syntactically, *ala* and *ana* both introduce complement clauses that are headed by a determiner: While *ala* conveys indicative, *ana* conveys subjunctive. *Ala* is used with factive verbs like ‘know’ to form ‘factual’ construals from a speaker’s point of view, as in (24a-b).

- (24) a. **Wa-thingal-aku ala** ka ma-drarangerange ka ladadre.  
 NFUT-know-1S.N ALA DET NFUT-hot/RED DET outside  
 ‘I know it’s pretty hot outside.’

- b. Wa-thingal-ako iniane **ala** ka ma-ligili.  
 NFUT-know-1S.N 3S.O ALA DET NFUT-smart  
 ‘I know he is smart.’

On the other hand, *ana*, which consists of the Perfect *na*, can only be used to convey counterfactual situations.

- (25) a. Ku aku, {**ana**/ #ala} ka a-mani-su, na-i-tarumar-aku.  
 DET 1S.N ANA/ ALA DET NFUT-be-2S.N PFT-FUT-accept-1S.N  
 ‘For me, if I were you, I would have accepted it (e.g. an option, a gift, etc.).’  
 b. **Ana** ka drarangerange ka ladadre amiyamiya kai Lrailrai.  
 ANA DET hot/RED DET outside say/PROG DEM Lrailrai  
 ‘Lrailrai was saying so (to hope) that it would be hot outside.’

In (25a), the speaker thought that it was not the case that the situation ‘I am you’ could be actually realized. It is infelicitous to use *ala* in this case. In (25b), *Lrailrai* was not sure whether ‘It is hot outside’ actually holds or not, but it tends to be the case that he thought that it was not hot outside.

Now let us turn to *If P, Q* conditionals. An example of past counterfactuals is like (26), in which the *if*-word contains Perfect *na*-. The speaker who utters (26) thinks that, with the accessible information and world knowledge given, it is actually not probable to snow on the plain. And if under that circumstance that it did snow, he would feel happy about that.

- (26) Past counterfactuals  
**Anaiyasi** pasabo kai datane, (**na**)-i-kiragadh-ako.  
 if/PFT snow DEM plain PFT-FUT-be happy-1S.N  
 ‘If it had snowed on the plain, I would have been happy.’

According to Iatridou (2000), ExclF is associated with the past morphology in the domain of worlds and is defined such that  $T(x)$  excludes  $C(x)$ , where  $x$  ranges over worlds. The topic worlds exclude the actual world, and this brings in the meaning of counterfactuality. Describing (26) in terms of ExclF, it follows that in the topic worlds where the meteorological conditions are met on the plain, it snows; and if it does, the speaker is happy. However, since the actual world is not among the topic worlds, the conditions are not met in it, and it does not snow on the plain.

In contrast, a conditional formed by *alaiyasi* implicates high probability of realization of a situation.<sup>7</sup> For example, sentence (27) implicates that the speaker thinks that for it to snow on the plain is possible and quite probable in the topic worlds, and thus the topic worlds may include the actual world.

## (27) Future-less-vivid conditionals/Present counterfactuals

Alaiyasi pasabo kai datane, (**na-**)i-kiragadh-ako.  
 if snow DEM plain PFT-FUT-be happy-1S.N  
 'If it snows on the plain, I will be happy.'

However, the alternation of Future vs. Future Perfect in a consequent clause of the various kinds of counterfactuals in Rukai, as in examples (26) and (27), does not seem to have an effect with respect to counterfactuality.

## 5 Conclusion

This paper shows that in Rukai the Perfect morpheme *na-* is responsible for a temporally past meaning, and also, it is used to convey counterfactuality as a morphological device. The temporal interpretation is attributed to the two components that are associated with the Perfect: the perfective viewpoint aspect and the semantic past. The analysis suggests that in languages that do not have a genuine past tense, the meaning of past and counterfactuality can be conveyed by the perfect morpheme. This may bear on the question of whether there is a uniform way to distinguish tense and aspect for a language like Rukai. Further research should deal with the remaining problem in this study that, when interacting with Perfect, the temporal adverbs apparently contribute in a different way from tensed sentences that provide a reference time. This makes the Rukai Perfect seem unusual when compared with other languages. While the semantics of Perfect *na-* has been provided in the domain of time, the generalization in the domain of worlds is left for further research.

## Notes

<sup>1</sup>This paper benefits from comments and suggestions from Lisa Green, Carlota Smith, Bernhard Schwarz and David Beaver. I want to thank my Rukai consultants, especially Muni (Ju-Hua Ke) and Salrabo (Chi-Chuan Ke) for their patience and kindness. Thanks also go to Elaine Chun for her proofreading this paper. All mistakes are my own responsibility.

<sup>2</sup>Also, the morphological realization of nonfuture and future tenses does not reflect the fact that Rukai distinguishes more than two temporal relations. Viewpoint aspects and situation types are also involved in temporal interpretations, such as the past.

<sup>3</sup>The abbreviations are: 1, first person; 2, second person; ACC, accusative; DEM, demonstrative; DET, determiner; FUT, future; GEN/G, genitive; IMPFV, imperfective; NEG, negative; NOM/N, nominative; NFUT, nonfuture; PFV, perfective; PROG, progressive. Orthography: lr, [l]; dr, [d]; dh, [ð]; th, [θ].

<sup>4</sup>The context is also responsible for possible inferences.

<sup>5</sup>This syntactic symmetry of Perfect *na-* and Future (*lr*)- suggests that both may be projected as a functional head before negation. A potential category of this projection can be mood or modality (Cinque 1999; Palmer 1986).

<sup>6</sup>The types of counterfactuals and conditionals discussed in Iatridou (2000) are: Counterfactual wishes, e.g. ‘I wish I had met you’; Present counterfactual (PresCF), ‘If he were smart, he would be rich’; Past counterfactual (PastCF), ‘If he had been smart, he would have been rich’; Future less vivid (FLV), ‘If I met you, I would tell you the truth’ (p.231-234).

<sup>7</sup>It remains unclear how the distinction between FLV and PresCF, if any, is made in Rukai.

## References

- Anderson, Alan R. 1951. “A note on subjunctive and counterfactual conditionals”, *Analysis*, 12:35–38.
- Beaver, David and Cleo Condoravdi. 2003. “A Uniform Analysis of Before and After”, in *Proceedings of SALT XIII*, ed. Rob Young and Yuping Zhou. Cornell: CLC Publications pp. 37–54.
- Cinque, Guglielmo. 1999. *Adverbs and Functional Heads: A Cross-Linguistic Perspective*. New York: Oxford University Press.
- Davidson, Donald. 1967. “The logical form of action sentences”, in *The Logic of Decision and Action*, ed. Nicholas Rescher. Pittsburgh: University of Pittsburgh Press.
- Dowty, David R. 1979. *Word Meaning and Montague Grammar: The Semantics of Verbs and Times in Generative Semantics and in Montague’s PTQ*. Dordrecht: D. Reidel Publishing Company.
- Giorgi, Alessandra and Fabio Pianesi. 1997. *Tense and Aspect: from Semantics to Morphosyntax*. (Oxford Studies in Comparative Syntax) New York and Oxford: Oxford University Press.
- Iatridou, Sabine. 2000. “The Grammatical Ingredients of Counterfactuality.” *Linguistic Inquiry*, 31. 2:231–270.
- Karttunen, Lauri and Stanley Peters. 1979. “Conventional Implicature”, in *Syntax and Semantics 11: Presupposition*, ed. Ch. K. Oh and P. A. Dinneen. New York: Academic Press pp. 1–56.
- Klein, Wolfgang. 1994. *Time in Language*. London: Routledge.
- Li, Paul Jen-kuei. 1973. *Rukai Structure*. Taipei: Institute of History and Philology, Academia Sinica.
- Li, Paul Jen-kuei. 1996. “The Pronominal Systems in Rukai”, in *Reconstruction, Classification, Description: Festschrift in Honour of Professor Isidore Dyen*, ed. Bernd Nothofer. Hamburg: Abera Verlag pp. 209–230.
- Li, Paul Jen-kuei (ed.). 1997. *The Formosan Languages in Kaohsiung*. Kaohsiung: Kaohsiung Prefecture Government.
- Lyons, John. 1977. *Semantics, vol. 2*. Cambridge: Cambridge University Press.
- McCoard, Robert W. 1978. *The English Perfect: Tense Choice and Pragmatic Inferences*. Amsterdam: North-Holland Press.
- Palmer, Frank Robert. 1986. *Mood and Modality*. Cambridge; New York: Cambridge University Press.
- Pancheva, Roumyana and Arnim von Stechow. 2004. “On the Present Perfect Puzzle”, in *Proceedings of NELS 34*, ed. K. Moulton and M. Wolf.
- Parsons, Terence. 1990. *Events in the Semantics of English*. Cambridge MA: MIT



- University Press.
- Ramchand, Gillian. 2006. *Verb Meaning and the Lexicon: A First Phase Syntax*. Manuscript.
- Reichenbach, Hans. 1947. *Elements of Symbolic Logic*. New York: The Free Press.
- Smith, Carlota S. 1997. *The Parameter of Aspect (Second Edition)*. Kluwer Academic Press.
- Smith, Carlota S., Ellavina Perkins and Ted Fernald. (In press, to appear 2007). "Time in Navajo: Direct and Indirect Interpretation", *International Journal of American Linguistics*.
- Zeitoun, Elizabeth, L. Huang, M. Yeh, A. Chang and J. Wu. 1996. "Tense, Aspect and Modality in Formosan Languages: a Typological Perspective", *Oceanic Linguistics*, 35.1:21–56.

Cheng-Fu Chen  
Department of Linguistics, University of Texas at Austin  
4400 Ave B APT 218, Austin TX 78751  
cfchen@mail.utexas.edu

# Rethinking Mass

Lindsey N. Chen

USC

## 1. Introduction

The semantics of mass terms is one of the familiar topics in philosophy and linguistics (cf. Pelletier 1979). Typical examples of mass terms are 'water', 'gold', 'snow', 'furniture', and 'clothing'. They differ from count nouns like 'cat', 'student' and 'apple' in that they cannot occur with indefinite articles, cardinal numerals and plural morphology. Also, mass nouns can be modified by 'much' and 'little' whereas count nouns can only be modified by quantifiers like 'many' and 'few'.

Now, an observation about mass terms in Spanish, and one not often discussed, is that they seem to come in two kinds- prototypical mass terms and collective mass terms. Examples of prototypical mass would be terms like *agua* 'water' and examples of collective mass would be terms like *mueble* 'furniture'. Within this paper, it is proposed that the two kinds of mass terms in Spanish have different extensions and operate on wholly different ontological level. Whereas prototypical mass terms denote quantities of substance, collective mass terms denote sets of individuals. By adopting this dual-view of mass terms, we will have avoided the confusion that results in lumping different "mass" terms together in some of the previous accounts (cf. Chierchia 1996). The proposed distinction is also of philosophical significance. What ontological labels attached to these terms is of importance because these labels reflect the most fundamental features of reality as presented to us. As the philosopher Brian Carr remarked: "Its subject matter is the most fundamental aspects of the way we think and talk about reality" (Carr 1987: 2).

## 2. The Data

In Spanish, terms like *agua* 'water' and *mueble* 'furniture' differ from each other in a number of respects. First, whereas *mueble* 'furniture' can appear in the plural form, *agua* 'water' cannot.

(1) El camión llevaba muebles  
 the truck carry-past-3-sg furniture-pl  
 “The truck carried furniture”

(2) Tome agua/\*aguas  
 drink-past-1-sg water  
 “I drank water”

Second, while *mueble* can be directly counted, *agua* cannot directly combine with a cardinal; compare (3) and (4).

(3) Compre dos muebles  
 buy-past-1-sg two furniture-pl  
 “I bought two pieces of furniture”

(4) \*Tome dos agua  
 drink-past-1-sg two water

For individuation of reference in (4) to be possible, a measure phrase or classifier phrase is obligatory, just like English.

(5) Tome dos litros/botellas de agua  
 drank-1-sg two liter-pl/bottle-pl of water  
 “I drank two liters/bottles of water”

Since the use of plural marker is not available with nouns like *agua*, it is expected that they would also differ from nouns like *mueble* in terms of their distribution with quantifiers of different number feature. This is true in Spanish. Whereas *mueble* can associate with quantifiers of plural form (*muchas/muchos*, *pocas/os*), *agua* cannot; the latter can only associate with quantifiers of singular form (*mucha/mucho*, *poca/o*); compare (6) and (7).

(6) La piscina tiene mucha agua/\*muchas aguas  
 the pool has much water  
 “The pool has a lot of water in it”

(7) El almacén vende muchos muebles  
 the store sell-pres-3-sg much furniture-pl  
 “The store sells a lot of furniture”

Further difference is exhibited through different verb number agreement. In (8), *nieve* ‘snow’ agrees with verb in the singular form but not verb in the plural

form. On the other hand, in (9), *mueble* ‘furniture’ can agree with verb in the plural form.

(8) La nieve se ha/\*han derretido  
 the snow 3-refl has/\*have melt-part  
 “The snow has/\*have melted”

(9) Los muebles han llegado  
 the-pl furniture-pl have-3-pl arrive-part  
 “The furniture have arrived”

Finally in Spanish, while the plural anaphoric pronoun cannot refer back to *agua* in (10), it can be used to refer back to *mueble*, as shown in (11).

(10) Kim encontró oro en Australia, pero es/\*son falso\*(s)  
 Kim find-past-1-sg gold in Australia but is/\*are fake  
 “Kim found gold in Australia but it is/\*they are fake”

(11) Kim compró muebles en AllAmerican, pero estaban hechos/  
 \*estaba hecho en China  
 Kim buy-past-1-sg furniture in AllAmerican but were made /  
 \*was made in China  
 “Kim bought furniture at AllAmerican but they were made in China”

### 3. A Dual-View of Mass Terms

Spanish, then, invites us to probe the connection between language and reality. Indeed, the language appears to be more explicit in regard to the metaphysical distinction within the mass category. In this paper, I propose that there are two kinds of mass terms in Spanish- prototypical mass and collective mass- and moreover, these two kinds of mass terms operate on wholly different ontological levels. Whereas terms like *agua* denote quantities of substance, terms like *mueble* denote sets of individuals. In a nutshell, the difference between prototypical mass and collective mass is essentially one between mereology versus sets. On the one hand, we have prototypical mass terms fitting the traditional stuff-fusion view of mass terms. On the other hand, we have collective mass terms fitting the plurality of individuals view. The following elaborates on these two conflicting views and argues why strictly adopting one would fail to accurately characterize the “mass” data observed in Spanish.

### 3.1. Of fusion and quantity

The relation between material objects and the matter of which they are composed has long been an interest to philosophers. In discussing such relation with respect to semantics, it is inevitable to bring up the topic of mass terms and in particular, what a mass term denotes. A well-known account is that of Cartwright (1970), which subscribes to the idea that occurrences of a mass term  $X$  are to be understood by the phrase ‘quantity of  $X$ ’. This concept of quantity and its associated notion ‘amount’ are further refined in ‘Amounts and Measures of Amount’ (1979), in which Cartwright elaborated on the properties of measurement of quantities. In her formalization of quantity, Cartwright invokes the notion of fusion. She defined the fusion of a set  $Q$  as “the object included in all and only those things which include every element of  $Q$ ” (Cartwright 1979: 184). Aware of the potential confusion over the use of ‘set’ and ‘element’, she emphasized that the inclusion relation in terms of which the fusion of a set is to be defined is not set-theoretic but mereological. The following illustrates the idea: Suppose  $Q$  = bucket of water. If  $Q$  is empty, its fusion has no subquantity which is a quantity of water. If  $Q$  is nonempty, then its fusion  $\mathbf{Fu}\{\}$  is the mereological union of its set of its subquantities. The measure of the quantity of water can then be obtained simply by applying a measure function  $\mathbf{m}$  to a set of subquantities:

$$(12) \mathbf{m}(\mathbf{Fu}\{x, y, z, \dots\}) = \mathbf{m}(x) + \mathbf{m}(y) + \mathbf{m}(z) + \dots \quad (\text{Cartwright 1979: 184})$$

Thus,  $\mathbf{m}$  is additive, reiterating the cumulative property of mass terms like ‘water’. Also, according to Cartwright, “we can preserve the fact that  $\mathbf{m}(x) > \mathbf{m}(y)$  if and only if  $x$  is as much water as  $y$  for every pair of elements in the domain of  $\mathbf{m}$ , by saying that wherever  $x$  is not a subquantity of  $y$ , there’s an element in the domain which a subquantity of  $x$  exclusively.” (Cartwright 1979:190) Though she did not use the term distributive property, the remark is a reference to such property, which mainly states that any part of something that is  $W$  is also  $W$ . (Cheng 1973).

Cartwright’s account of mass terms in terms of quantity and its associated notion amount are insightful and at the same time, intuitively appealing. Essentially, under her account, mass nouns amount to measuring stuff. Measurement is a kind of number assignment and in this kind of number assignment, the number tells something about the extensive property (e.g. volume), as denoted by the measure unit, of the empirical objects, not the cardinality of the empirical object. Thus, we do not enumerate ‘\*one water, two water, etc’ (or *\*un agua, dos agua...*). There just is no determinate principle for counting the number of quantities of, say, water in a single cup. Moreover, the notion of ‘quantity’ does not have clear boundaries to provide a criterion for counting. Normally, counting requires that the concept draw precise boundaries

around each object in its extension. Quantity, however, does not have clear boundaries and thus for any kind of “counting” in (5) to make any sense, we need to know specifically whether we are talking about *litros* ‘liters’ or *botella* ‘bottles’. It is these specific reference-dividers that do the work in singling out individual portions of *agua*. This contrast with terms like *mueble*, in which direct counting is possible, as seen in (3). The conceptual difference is this: the referent of the term *mueble* ‘(piece of) furniture’ possesses precise, identifiable boundaries around the object to provide a criterion for counting. As further illustration of this distinction- that the reference of prototypical mass lacks what philosophers call “criteria of identification” (cf. Laycock 1975) whereas collective mass do not- consider the following thought experiment:

Mrs. Gonzalez is the manager of a new furniture store. Bill, a high school student studying for the Advanced Placement Spanish Exam, asks Mrs. Gonzalez to be his conversation partner in exchange for his help with the inventories. One day, Bill saw some furniture in the display room that he thought should not be there so he moved ‘un mueble’ in stockroom A and the other in stockroom B. When Bill left and Mrs. Gonzalez came in to the display room, she realized the missing furniture. Now, even though Mrs. Gonzalez is not able to identify which ‘mueble’ is in A and which is in B, the fact is, she is certainly ABLE to identify it. Why? Because ‘los muebles’ along with other material objects have a built-in structure so that one is able to pick out and distinguish some of it from some other. There is a unique and specifiable procedure for dividing up ‘los muebles’ into discrete parts such that one of these will in fact be the “un mueble” that ends up in A and the other in B though supposedly Mrs. Gonzalez does not know which is which. Now, this is not so with matter. Suppose there’s a tank containing ‘agua’ and Bill pours it into two glasses- A and B. It’s plain that Mrs. Gonzalez cannot identify the ‘agua’ that will be in A or B. She is unable to identify that water at all because there’s no specifiable procedure whereby the water in the tank can be divided into discrete parts per se such that one of these parts will consist of the water that ends up in A and the other in B.

Indeed, cases like ‘furniture’ (or *mueble*) would be problematic for quantity-based account of mass terms. According to Cartwright, “Part of what is meant by saying something is a quantity of water is that it has subquantity of water which is a quantity of water.” (Cartwright 1979: 190). For collective mass terms, such account does not seem to be apt, for what does it mean to be a quantity of furniture, to have part of it which is also a subquantity of furniture, if there is such a thing? Are there really quantities of stuff like furniture? In the following section, the plurality view is applied to collective mass instead.

### 3.2. A plurality of individuals

In the later semantics literature, the view shifted to mass terms as denoting a plurality of things. The first to formally put forth this proposal was Link (1983).

As noted by Link, there appears to be a striking similarity between collective predication and predication involving mass nouns:

(13) The children gather around their teacher

(14) The water gathers in big pools

A characteristic feature of mass terms noted earlier by Quine (1968)- the cumulative property - was also noted by Link as a feature of plurals.

(15) If  $a$  is water and  $b$  is water then the sum of  $a$  and  $b$  is water

(16) If the animals in this camp are horses, and the animals in that camp are horses, then the animals in both camps are horses

A basic question then arises: what do mass terms and plural expressions denote? Unlike his predecessors from the philosophical school, Link (1983) and subsequently (Gillon 1992) and (Chierchia 1996) do not treat mass terms as denoting quantity or some kind of fusion-whole. Rather, they propose that mass terms denote a plurality of individuals and properties like cumulative reference can be accounted for by employing a set-theoretic metalanguage. Crucially, their formalization assumes a domain of entities constituting a complete free atomic join semi-lattice containing both singular entities (atoms) and their sums (pluralities).

(17)    “cats” = [        {f, b, s}        ]  
                   [ {f,b}   {b,s}   {f,s} ]  
          “cat”    [ f, b, s ]            =  $At$

A singular count noun is taken to denote a class of objects or individuals. It constitutes the reference of singular definite DPs like ‘Jack’, ‘that cat’. The individuals in bracket are the plural ones and constitute the reference of plural definite DPs like ‘Jack and Jill’, ‘those cats’. Here, the domain is ordered by a relation  $\leq$ , which can be thought of as a subgroup or ‘part-of’ relation. In terms of  $\leq$ , a join operator  $U$  can be defined in the usual manner. Adopting the lattice model, Chierchia (1996), for example, proposes that mass noun simply denotes a set of ordinary individuals plus all the pluralities of such individuals. In the case of Spanish, then, *mueble* would denote the set of those singular pieces and *muebles* the sets including the combination of those pieces. For the referent of collective mass terms, the model is indeed apt. The “atoms” as primitives are a way of considering entities as something that can be counted.

(18)    *muebles* “pieces of furniture” = [        {f, b, s}        ]

$$\begin{array}{l}
 \text{mueble "piece of furniture"} \quad [ \{f,b\} \quad \{b,s\} \quad \{f,s\} ] \\
 \quad \quad \quad \quad \quad \quad [ f, b, s ] \quad \quad \quad = At
 \end{array}$$

Granting the plurality view for terms like *mueble*, we can account for the selectional restriction observed in the following:

- (19) Kim *recolocó/ separó* los sellos/ \*el sello  
 Kim rearrange/separate-past-3-sg the-pl stamp-pl/the-sg stamp  
 “Kim rearranged (or separated) the stamps/\*stamp”
- (20) Kim *recolocó/ separó* los muebles/\*el mueble  
 Kim rearrange/separate-past-3-sg the-pl furniture/\*the-sg furniture  
 “Kim rearranged (or separated) the furniture”  
 But not: “Kim rearranged (or separated) a piece of furniture”
- (21)??Kim *recolocó* agua  
 Kim rearrange-past-3-sg water  
 “Kim rearranged water”

Here, certain verbs take particular nouns as arguments- namely nouns denoting a plurality of things. For example, the act of separating normally requires that there must be at least two or more concrete objects for which any separation is to be possible. In (19) and (20), *separó los sellos* and *separó los muebles* - ‘separated the stamps’ and ‘separated the furniture’ respectively - are acceptable because in both cases, the argument denotes a plurality of individuals. However, this is not so with the singular counterpart *sello/mueble* as well as *agua* in (21). The upshot is that interpretability of these examples is dependent on whether the referent of the argument NP is a collection of things or not.

Indeed, it’s somewhat implausible to say that prototypical mass terms such as ‘water’ refer to a plurality of discrete individuals. The pluralists would like to propose so, though not without running into the risk of contradicting themselves at times. For instance, at the inception, Chierchia (1996) states: “We are committed to claiming that for each mass noun there are minimal objects of that kind, just like for count nouns...” (p. 55). Under this picture, the view of mass nouns is an atomistic one. Where problems arise is when mass examples like ‘water’ are to be accounted for. Non-solid substances as referred to by ‘water’, he explains, are “undoable to isolate a suitable set of singularities” (Chierchia 1996: 83). That is to say, the referent of mass nouns has no minimal component in which we can isolate. Yet this is opposite of what Chierchia’s central thesis suggests at the beginning.

Consider also the impossibility of combining numerals with mass nouns. Chierchia (1996) explains that to count, one needs a suitable level at which the objects to be counted can be individuated. The term ‘tables’ provides a counting



criterion but mass nouns, on the other hand, do not provide us with good useful level at which to count. The distinction, then, is basically one of atomic versus nonatomic. In all count nouns, the lexical entry singles out a set of atoms. With regard to count nouns and mass nouns, Chierchia remarks that in the former “the atomic granularity is presupposed” but in the latter, they are “too vague for direct counting” (Chierchia 1996). To check the status of a noun, Chierchia employs what he calls the singular (SG) checking function, which in turn acts as a domain regulator for the numerical function. The idea is that since a set with no “atomic texture” will come out of the SG function undefined and the denotation of numerals utilizes SG to get at the proper restriction, the numerical function would also be undefined. Therefore, numerals cannot combine with mass nouns.

For count nouns, an atomistic-based characterization makes intuitive sense. Yet, having said that mass terms do not provide a useful level to count, why propose that mass nouns denote a set of individuals plus all the pluralities of such individuals, thus contradicting the aforementioned explanation regarding the impossibility of associating cardinals with mass nouns? In addition, the question-begging SG checking function is a problem rather than a solution. Supposedly, if we throw in ‘water’ into the checking function, we will get an undefined value because these stuffs have no “atomic granularity”. And the reason? Because the output of SG function is undefined. The statement below says that SG provides a defined value if A has “an atomic granularity”. But whether or not the set has “an atomic granularity” is exactly what the function is supposed to tell us!

This checking can be done by a function SG which applied to any property extension A returns it if A has an atomic granularity and otherwise undefined  
(Chierchia 1996: 71)

Chierchia’s stance on the nature of mass nouns is, in fact, non-committal and at times, confusing. As a result, we are back to square one in considering mass as some “substance whose minimal components are somehow elusive” (Chierchia 1996:54).

Yet, the reference of mass terms need not be an elusive notion if we adopt the proposed dual-view of mass terms. The plurality view would be appropriate for collective mass terms but not prototypical mass terms. With respect to the Spanish data, the reference of *muebles* can be said to divide into discrete objects and because of this possibility we can pick out an individual object and count how many there are (*Quantos muebles?*) in a given space. Prototypical mass terms like *agua* on the other hand, do not divide their reference into discrete individuals and as such we cannot ask how many of it there are. Rather, we ask how much there are for the concern of a quantity-based proposal is on the measure of amount, not countability of discrete spatial entities.

#### 4. Conclusion

Within this paper, it is proposed that there are two kinds of mass terms in Spanish- prototypical mass terms and collective mass terms- and each operates on a different ontological level. Whereas prototypical mass terms have quantities of substance in their extension, collective mass terms have sets of individuals in their extension. By adopting this dual-view of mass terms, we not only avoid the confusion that results in lumping different “mass” terms together in the previous accounts but also achieved a more faithful picture of reality about things and objects.

#### 5. Reference

- Carr, Brian. 1987. *Metaphysics: An Introduction*. New Jersey: Humanities Press International.
- Cartwright, Helen. 1970. ‘Quantities’, *Philosophical Review*, 79:25-42.
- Cartwright, Helen. 1975. ‘Amounts and Measures of Amounts’, *Nous* 9:143-164.
- Cheng, CY. 1973. ‘Response to Moravcsik’. J. Hintikka et al (eds.), *Approaches to Natural Language*, Dordrecht: D. Reidel Publishing Company. 286-288.
- Chierchia, Gennaro. 1996. ‘Plurality of Mass Nouns: On the Notion of ‘Semantic Parameter’. Ms, University of Milan.
- Gillon, Brendon. 1992. ‘Towards a Common Semantics for English Count and Mass Nouns’, *Linguistics and Philosophy* 15: 597-639.
- Laycock, Henry. 1975. ‘Theories of Matter’, *Synthese* 31: 411-442.
- Link, Godehard. 1983. ‘The Logical Analysis of Plurals and Mass Terms: A Lattice Theoretical Approach’, R. Bauerle, C. Schwarze and A von Stechow (eds), *Meaning, Use and Interpretation of Language*. Berlin: De Gruyter. 302-323.
- Quine, Willard V.O. 1960. *Word and Object*. Cambridge: The MIT Press.
- Pelletier, Francis. 1979. *Mass Terms: Some Philosophical Problems*, Dordrecht: D. Reidel Publishing Company.
- Vendler, Zeno. 1967. *Linguistics in Philosophy*. Ithaca: Cornell University Press.

*Lindsey N. Chen*  
*University of Southern California*  
*chenlindsey@yahoo.com*

# Left-to-Right Incrementality and Scrambling in Korean/Japanese

Youngju Choi

University of Illinois at Urbana-Champaign

## 1. Introduction

Languages differ in the word order and the flexibility of the order. Do they have the same order and the same configuration in the deep level, as the generative tradition believes? Or do they adopt a different mechanism in expressing the relation between forms and meanings (Baker 1996, 2001, Bouchard 1997, 2001)? For K(orean)/J(apanese) scrambling, most of the approaches have been proposed under the former assumption where scrambling should be an instance of movement, obligatory or optional (Miyakawa 1997, 2003, Saito 1989, 1992, 2003, Y-S Lee 1993) to keep the same configuration with English-type languages in the deep level.

The purpose of the paper is to show that scrambling of K/J is not an instance of movement but a result of **left-to-right incremental structure building (LRI** : Phillips 2003), derived by **dependent markers**. To implement the idea, categorial unification grammar will be adopted (Karttunen 1989, Uszkoreit 1986) and the dependent markers are specified as having combinatoric information in the lexicon. The dependent markers change NPs into functors which seek their predicate as their argument. Case marked NPs combine with each other, forming a big functor, expecting an appropriate predicate. The same set of predicates will be chosen regardless of the order between NPs since when NPs are combined in any order, the argument values of them will be unified into the same set, resulting in **local scrambling**. In **long scrambling** where a scrambled NP is out of its clause, the content value of the scrambled NP becomes relocated in its own clause by the lexical information of the complementizer *-ko*.

## 2. A Proposal

As is assumed in Karttunen (1989) for Finnish, K/J verbs are assumed to be of simple category V instead of being a functor, as shown in (1). Verbs have slots for a subject and/or an object for unification.

(1) manna- ‘meet’  $\left( \begin{array}{l} \text{category V} \\ \text{syntax} \left( \begin{array}{l} \text{subject [ ]} \\ \text{object [ ]} \end{array} \right) \end{array} \right)$

As shown in (2a) and (2b), case markers are treated as a separate word in the lexicon. When they are combined with bare NPs, the result will be of category V/V which requires a verb as its argument. The argument value of the result for a nominative marker is V[Subj] (a verb with a subject slot), V[Subj, Obj] (a verb with a subject and an object slots), or V[Subj, IObj, DObj] (a verb with a subject slot, an indirect object slot and a direct object slot). The argument value of the result for an accusative marker is more restricted to V[Subj, Obj], or V[Subj, IObj, DObj]. Thus, an accusative-marked NP is not compatible with a verb with a subject slot, namely an intransitive verb.

(2) a. *-ka/i* ‘nom’

$$\left( \begin{array}{l} \text{result cat: V/V} \\ \text{syntax: subj} \left( \begin{array}{l} \text{semantics:[1]} \\ \text{morphology: case: nom} \end{array} \right) \\ \text{dir:right} \\ \text{arg: V[Subj] } \vee \text{ V[Subj, Obj] } \vee \text{ V[S, IO, DO]} \\ \text{dir: left} \\ \text{arg: semantics [1]} \end{array} \right)$$

b. *-(l)ul* ‘acc’

$$\left( \begin{array}{l} \text{result cat: V/V} \\ \text{syntax:object} \left( \begin{array}{l} \text{semantics:[1]} \\ \text{morphology: case: acc} \end{array} \right) \\ \text{dir:right} \\ \text{arg: V[Subj, Obj] } \vee \text{ V[S, IO, DO]} \\ \text{dir: left} \\ \text{arg: semantics [1]} \end{array} \right)$$

To show how the information of the case markers derives structure building, I am going to show the derivation of a simple transitive sentence, (3).

- (3) *Yenghi-ka Cheli-lul manna-ss-ta*  
 Y-Nom C-Acc meet-Pst-Dcl  
 ‘Yenghi met Cheli’ (Korean)

When the nominative marker *-ka* is combined with *Yenghi*, and the accusative marker *-lul* is combined with *Cheli*, (4a) and (4b) are resulted, respectively, as are expected in the result values of case markers.

- (4) a. *Yenghi-ka*
- $$\left( \begin{array}{l} \text{cat: V/V} \\ \text{result} \left( \begin{array}{l} \text{cat:V} \\ \text{syntax: subject} \left( \begin{array}{l} \text{semantics:Yenghi} \\ \text{morphology:case:nom} \end{array} \right) \end{array} \right) \\ \text{dir: right} \\ \text{arg: V[Subj] } \vee \text{ V[Subj, Obj] } \vee \text{ V[S, IO, DO]} \end{array} \right)$$
- b. *Cheli-lul* ‘Cheli-Acc’
- $$\left( \begin{array}{l} \text{cat: V/V} \\ \text{result} \left( \begin{array}{l} \text{cat:V} \\ \text{syntax: object} \left( \begin{array}{l} \text{semantics:Cheli} \\ \text{morphology:case:acc} \end{array} \right) \end{array} \right) \\ \text{dir: right} \\ \text{arg: V[Subj, Obj] } \vee \text{ V[S, IO, DO]} \end{array} \right)$$

When two case-marked NPs are combined, the information from each are unified as in (5). The argument values are unified into the least sum (disjunctive value unification).

- (5) a. *Yenghi-ka Cheli-lul* ‘Yenghi-Nom Cheli-Acc’
- $$\left( \begin{array}{l} \text{result} \left( \begin{array}{l} \text{cat:V} \\ \text{syntax} \left( \begin{array}{l} \text{subject} \left( \begin{array}{l} \text{semantics:Yenghi} \\ \text{morphology:case:nom} \end{array} \right) \\ \text{object} \left( \begin{array}{l} \text{semantics:Cheli} \\ \text{morphology:case:acc} \end{array} \right) \end{array} \right) \end{array} \right) \\ \text{dir: right} \\ \text{arg: V[Subj, Obj] } \vee \text{ V[S,IO, DO]} \end{array} \right)$$

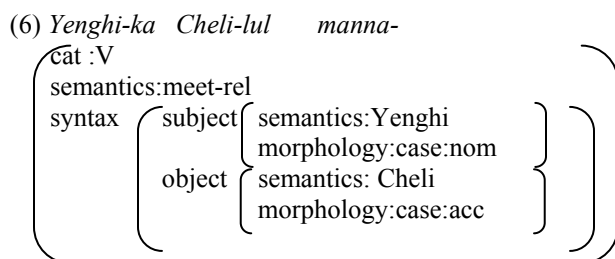

The result of the derivation will be as follows.

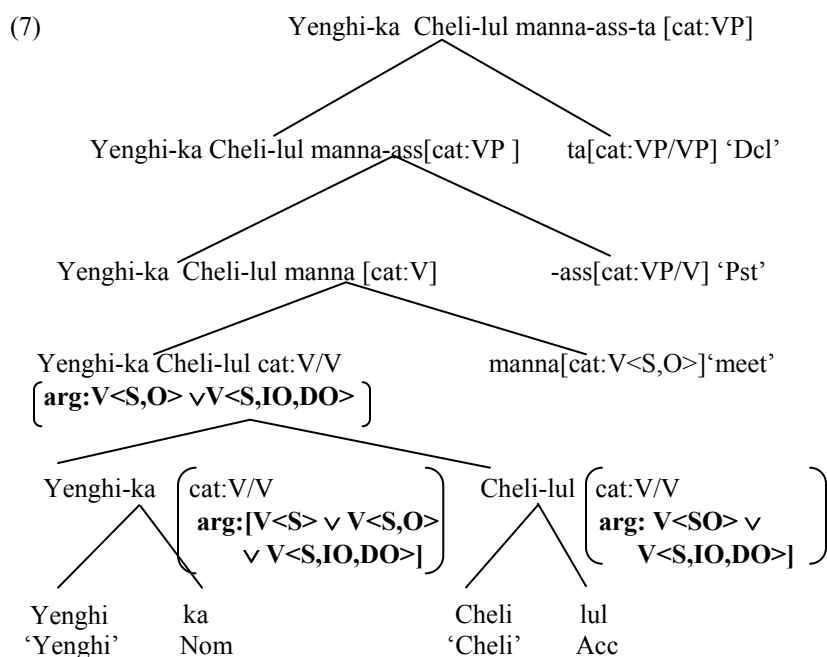

### 3. Local and Long Scrambling

As was introduced, local scrambling is easily explained in the proposed system. In (8), an accusative NP comes first instead of a nominative NP. If an NP is marked with an accusative, its syntactic value is fixed as an object and if an NP is marked with a nominative, its syntactic value is fixed as a subject. Thus, regardless of the order, their grammatical function is fixed by the case markers they combine with. When two NPs are combined together, the result of unification is exactly same as the unscrambled sentence, as shown in (9e). Argument values are not affected by the temporal order, either.

- (8) Cheli-lul Yenghi-ka manna-ss-ta  
 C-Acc Y-Nom meet-Pst-Dcl  
 ‘Yenghi met Cheli’ (Korean)

(9) a. [<Cheli> ]

→b. [<Cheli-lul(Acc)><sub>V/V</sub> ]

→c. [<Cheli-lul(Acc)><sub>V/V</sub> <Yenghi> ]

→d. [<Cheli-lul(Acc)><sub>V/V</sub> <Yenghi-ka(Nom)><sub>V/V</sub>]

→e. [[<Cheli-lul(Acc)> <Yenghi-ka(Nom)>]<sub>V/V</sub>]

e. *Cheli-lul Yenghi-ka* ‘Cheli-Acc Yenghi-Nom’

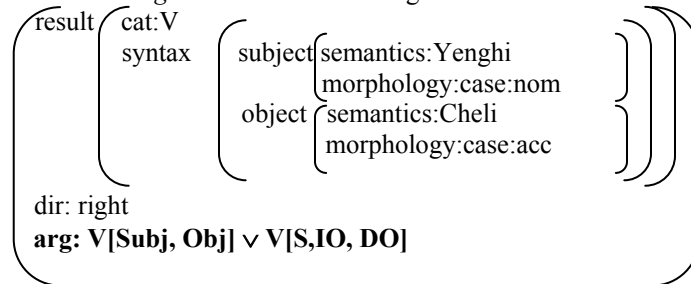

→f. [[<Cheli-lul(Acc)> <Yenghi-ka(Nom)>]<sub>V/V</sub> <manna-><sub>V</sub>]

→g. [[<Cheli-lul(Acc)> <Yenghi-ka(Nom)>> <manna->]<sub>V</sub>]

The same explanation is applied to ditransitive constructions. When three case-marked NPs combine with each other, regardless of the order of (10), they have the same result as in (11). When a dative NP is added, the least sum of argument values are further restricted to exclude verbs with a subject slot and verbs with a subject and an object slots. Only verbs with three slots are allowed.

- (10) a. Yenghi-ka Cheli-lul Tongswu-eykey sokayhay-ss-ta<sup>1</sup>  
 Y-Nom C-Acc T-Dat introduce-Pst-Dcl  
 b. Cheli-lul Yenghi-ka Tongswu-eykey sokayhay-ss-ta  
 C-Acc Y-Nom T-Dat introduce-Pst-Dcl  
 c. Tongswu-eykey Yenghi-ka Cheli-lul sokayhay-ss-ta  
 T-Dat Y-Nom C-Acc introduce-Pst-Dcl  
 ‘Yenghi introduced Cheli to Tongswu’ (Korean)

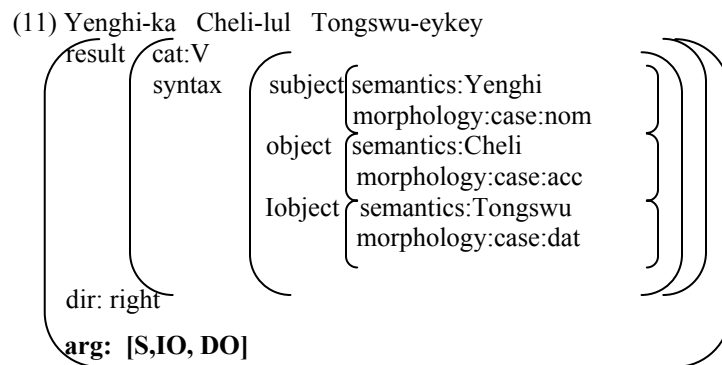

Example in (12b) is scrambled counterpart of (12a). The scrambled NP *Cheli-lul* is outside of the original clause, resulting in long scrambling.

- (12)a. Yenghi-ka [ Swunhi-ka Cheli-lul manna-ss-ta-ko ] sayngkakhay-ess-ta  
 Y-Nom S-Nom C-Acc meet-Pst-Dcl-Comp think-Pst-Dcl  
 b. Cheli-lul [Yenghi-ka [Swunhi-ka manna-ss-ta-ko] sayngkakhay-ess-ta]  
 C-Acc Y-Nom S-Nom meet-Pst-Dcl-Comp think-Pst-Dcl  
 ‘Yenghi thought that Swunghi met Cheli’ (Korean)

Since the derivation is assumed to be left-to-right, the scrambled NP *Cheli-lul* is combined with the subject of the main clause as in (13b). However, since the next NP is again a nominative NP, unification fails, as in (13d). Both *Yenghi* and *Swunhi* will be marked as subject because they have the same nominative markers. Two different semantic values cannot be unified into a single slot. Thus, the previous combination is destroyed, as in (13e) where every case marked NP gained its category, V/V, again.

- (13) a. [<Cheli-lul><sub>V/V</sub> ]  
 b. [<Cheli-lul><sub>V/V</sub> <Yenghi-ka><sub>V/V</sub>]  
 c. [[<Cheli-lul> <Yenghi-ka>]<sub>V/V</sub>]  
 d. [[<Cheli-lul> <Yenghi-ka> <Swunhi-ka>]<sub>V/V</sub>] **unification failure**  
 e. [<Cheli-lul><sub>V/V</sub> <Yenghi-ka><sub>V/V</sub> [[[<Swunhi-ka> <manna>-ass-ta]-ko]<sub>V/V</sub>]

Here, the role of the complementizer is important. The lexical specification of it is shown in (14). When it takes its VP argument, if it finds that an object value and/or an indirect object value of the VP is not filled and if it finds any NPs with



the object value and the indirect object value in its left, it fills the values for the VP using the values of the NPs. Thus, the effect of the lexical specification of the complementizer is to lower scrambled element to the original position.<sup>2</sup>

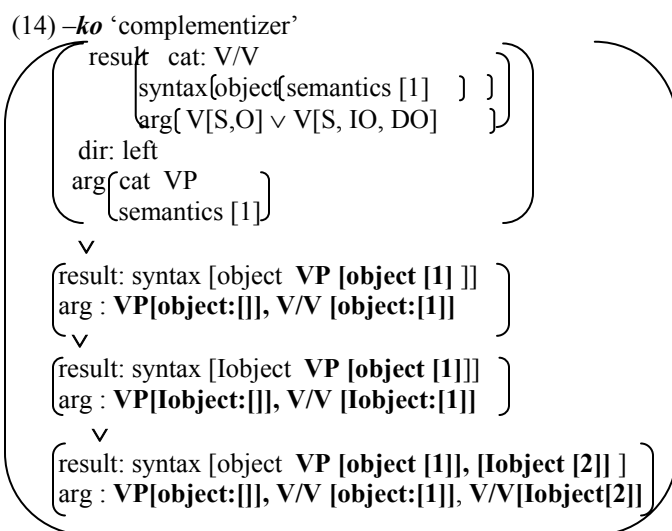

#### 4. More facts on Scrambling

As has been observed in Saito (1989, 1992, 2003), Saito and Fukui (1998) and many others, scrambling shows radical reconstruction effect. While sentence (15b) where the *wh* word are out of scope of Q marker is ungrammatical, sentence (16b) where scrambled *wh*-word appears outside of Q marker is grammatical. It means scrambled *wh*-word has to be interpreted in its original position.

- (15)a. [<sub>TP</sub>John-ga [<sub>CP</sub>[<sub>TP</sub>dare-ga sono hon-o katta] ka] siritagatteiru] (koto)  
 J-Nom who-Nom that book-Acc bought Q want-to-know fact  
 ‘[John wants to know [Q[who bought that book]]]’
- b. \* [<sub>TP</sub>Dare-ga [<sub>CP</sub>[<sub>TP</sub>John-ga sono hon-o katta] ka] siritagatteiru] (koto)  
 who-Nom J-Nom that book-Acc bought Q want-to-know fact  
 ‘[Who wants to know [Q[John bought that book]]]’ (Saito 2003:483, (4))
- (16) a. [<sub>TP</sub>John-ga [<sub>CP</sub>[<sub>TP</sub>Mary-ga dono hon-o yonda]ka]siritagatteiru] (koto)  
 J-Nom M-Nom which book-Acc read Q want-to-know fact  
 ‘[John wants to know [Q[Mary read which book]]]’

- b. [<sub>TP</sub>**dono hon-o**<sub>i</sub> [John-ga]<sub>CP</sub>[<sub>TP</sub>Mary-ga *t<sub>i</sub>* yonda]ka] siritagatteiru] (koto)  
 which book-Acc J-Nom M-Nom read Q want-to-know fact  
 ‘[Which book<sub>i</sub> John wants to know [Q[Mary read *t<sub>i</sub>]]]’ (Saito 2003:483, (6))*

The Q marker is very similar to the complementizer in the sense that when it takes its argument VP (which is a TP in the given example), it fills the object and/or the indirect values for the VP using the values of any remnant case-marked NPs. Thus, in (16b), *Mary-ga yonda ka* has the following specification after the Q marker fills the object value of *Mary-ga yonda* using the object value of *dono hon-o*. Thus, *dono hon-o*, in effect, goes down to be under the scope of the Q-marker. On the other hand, in (15b), the problematic *dare-ga* cannot be saved by the active role of Q-marker since it, as a subject with the nominative marker, is not qualified to be lowered.

Scrambling is subject to the proper binding condition (Saito 2003). If movement is assumed, it seems that the ungrammaticality of (17a) can be easily explained. The trace *t<sub>j</sub>* is not properly governed.

- (17)a. \* [<sub>TP</sub> [Hanako-ga *t<sub>i</sub>* iru to]<sub>j</sub> [Sooru-ni<sub>i</sub> [Taroo-ga *t<sub>i</sub>* omotteiru]]] (koto)  
 H-Nom be that Seoul-in T-Nom think fact  
 ‘[That Hanako lives *t<sub>i</sub>*], in Seoul<sub>i</sub> [Taroo thinks *t<sub>j</sub>*]’ (Saito 2003: 498, (49))  
 b. [<sub>TP</sub> [Taroo-ga [Hanako-ga Sooru-ni iru to] omotteiru]]] (koto)  
 T-Nom H-Nom Seoul-in be that think fact  
 c. [Hanako-ga Sooru-ni iru to]<sub>j</sub> [<sub>TP</sub> [Taroo-ga *t<sub>j</sub>* omotteiru]]] (koto)  
 H-Nom Seoul-in be that T-Nom think fact  
 d. Sooru-ni<sub>i</sub> [Hanako-ga *t<sub>j</sub>* iru to] [<sub>TP</sub> [Taroo-ga omotteiru]]] (koto)  
 Seoul-in H-Nom be that T-Nom think fact  
 e. \*[Hanako-ga *t<sub>i</sub>* iru to] Sooru-ni<sub>i</sub> [<sub>TP</sub> [Taroo-ga omotteiru]]] (koto)  
 H-Nom be that Seoul-in T-Nom think fact

However, the ungrammaticality is explained with assuming movement. When *Hanako-ga* ‘Hanako-Nom’ hit the predicate *iru* ‘be’, the predicate requirement of the functor *Hanako-ga* is resolved. *Sooru-ni* ‘Seoul-in’ is combined with *Taroo-ga* ‘Taroo-Nom’ and when the combination hits the predicate *omotteiru* ‘think’, derivation ends with the interpretation of ‘Taroo think in Seoul that Hanako lives’

K/J allows multiple scrambling as in (18). (18b) is a scrambled counterpart of (18a).

- (18) a. Cheli-ka Tongswu-ka **chayk-ul** **Yenghi-eykey**  
 C-Nom T-Nom book-Acc Y-Dat  
 cwu-ess-ta-ko sayngkakhay-ess-ta  
 give-Pst-Dcl-Comp think-Pst-Dcl

- b. **chayk-ul Yenghi-eykey** Cheli-ka  
 book-Acc Y-Dat C-Nom  
 Tongswu-ka cwu-ess-ta-ko sayngkakhay-ess-ta  
 T-Nom give-Pst-Dcl-Comp think-Pst-Dcl  
 ‘Cheli thought that Tongswu gave the book to Yenghi’

However, when two scrambled NPs are from two different clauses as in (19b), ungrammaticality is resulted. The scrambled NPs are combined together, and when they are lowered to the embedded clause, they have to be lowered at the same time. However, the embedded clause in (19b) does not have available slot for the indirect object unlike (18b).

- (19) a. Cheli-ka **Tongswu-eykey**  
 C-Nom T-Dat  
 Yenghi-ka **chayk-ul** ilk-ess-ta-ko malhay-ess-ta  
 Y-Nom book-Acc read-Pst-Dcl-Comp say-Pst-Dcl  
 b. ?\***Tongswu-eykey chayk-ul** Cheli-ka  
 T-Dat book-Acc C-Nom  
 Yenghi-ka ilk-ess-ta-ko malhay-ess-ta  
 Y-Nom read-Pst-Dcl-Comp say-Pst-Dcl  
 ‘Cheli said to Tongswu that Yenghi read the book’

## 5. Remaining Issues

### 5.1 canonical order vs. scrambled order

As has been shown, local scrambling should be free, why is there canonical order? It is because, in unifying valencies of case marked NPs, the system prefers reduction. A Nom-Acc string reduces the valencies. The first NP allows more options for its argument while the second NP has narrower choices. When the options are unified, due to the second NP, the least sum is reduced. However, in an Acc-Nom string, the second NP which is marked with a nominative does not contribute in reducing the valencies as shown in (20b).

- (20) a. **NOM-ACC string**[arg: V(S,O)∨ V(S,IO,DO)]
- 
- ```

graph TD
    A["NOM-ACC string [arg: V(S,O)∨ V(S,IO,DO)]"] --> B["Nom-marked NP [arg: V(S)∨ V(S,O)∨ V(S,IO,DO) ∨ ...]"]
    A --> C["Acc-marked NP [arg: V(S,O)∨ V(S,IO,DO)]"]
  
```

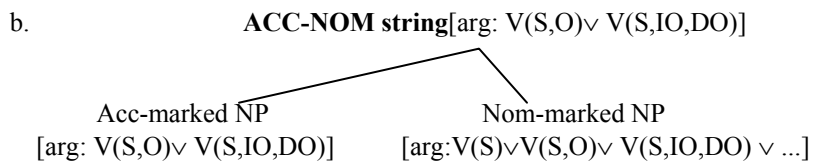

As shown in the hierarchy, whenever an accusative NP appears, a nominative NP is presupposed.

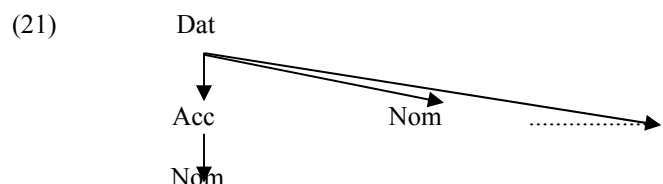

## 5.2 Word Order Freezing

When there is no case marker, word order should be kept. If the order is switched, the meaning is changed. In the proposed system, the relation between case marker drop and order freezing is well explained. Bare NPs are not functors any more since it is case markers that turn NPs into functors. Thus, the valency slots of verbs are filled by virtue of the relative position of NPs. In transitive constructions, the closer NP to verbs fills the object slot and the rest the subject slot. In (22a), *Cheli*, being closer to the verb *manna-*, fill the slot of object and in (22b), *Yenghi*, being closer to the verb, fill the slot of object.

- (22) a. Yenghi Cheli manna-ss-ta  
 Y C meet-Pst-Dcl  
 'Yenghi met Cheli'  
 b. Cheli Yenghi manna-ss-ta  
 C Y meet-Pst-Dcl  
 'Cheli met Yenghi'

The above explanation can be extended to partial drop data. When one NP does not bear a case marker among two NPs, only one option is not allowed among four different possibilities; when a nominative marker is dropped and an accusative NP is scrambled as in (23d). The unacceptability of the sentence is due to the fact that the bare NP which is closer to the verb should be identified as an object.

- (23) a. Cheli-ka Yenghi-Ø cohahan-ta  
 C-Nom Y like

- b. Cheli- $\emptyset$  Yenghi-**lul** cohahan-ta  
 C Y-Acc like-Dcl
- c. Yenghi- $\emptyset$  Cheli-**ka** cohahan-ta  
 Y C-Nom like-Dcl
- d. \*Yenghi-**lul** Cheli- $\emptyset$  cohahan-ta  
 Y-Acc C like-Dcl  
 ‘Cheli likes Yenghi’

## 6. Conclusion

As Bouchard (1997, 2001) points out, languages differ in the way the relation of arguments and predicates is encoded. Some languages mark arguments, some languages mark predicates, and some languages use rigid order. Korean/Japanese mark arguments using case markers. Fixed order is not necessary to encode the relation of the arguments and predicates. Kiparsky (1997) also demonstrated the view that an argument must be licensed either by position or by morphological case. In the lexicon, abstract case features of arguments of a predicate are connected with position features in one layer and with morphological case features in the other layer. If both of the layers do not match with abstract case layer, the predicate is ruled out. Though mechanisms are different, Bouchard (1997, 2001) and Kiparsky (1997) share the insight that some languages do not need rigid order due to morphological licenser/encoder.

I have claimed that NPs are turned into a functor, looking for an appropriate predicate when they are combined with case markers in K/J-type languages, along the line with Choi and Yoon (2006) and Yoon and Lee (2005). It has been shown that the idea can explain local and long scrambling, and well-known facts on scrambling in K/J.

## Notes

<sup>1</sup> When three NPs are involved, six different orders are possible. Other than three examples given in the main text, the following three examples are also possible.

- a. Yenghi-ka Tongswu-eykey Cheli-lul sokayhay-ss-ta  
 Y-Nom T-Dat C-Acc introduce-Pst-Dcl
- b. Cheli-lul Tongswu-eykey Yenghi-ka sokayhay-ss-ta  
 C-Acc T-Dat Y-Nom introduce-Pst-Dcl
- c. Tongswu-eykey Cheli-lul Yenghi-ka sokayhay-ss-ta  
 T-Dat C-Acc Y-Nom introduce-Pst-Dcl  
 ‘Yenghi introduced Cheli to Tongswu’

<sup>2</sup> In the remote sense, it is similar to the LF lowering of scrambled element which is claimed by Bošković and Takahashi (1998).

---

## References

- Baker, M. C. 1996. *The Polysynthesis Parameter*. Oxford Studies in Comparative Syntax: Oxford, New York.
- Bošković, Ž. and D. Takahashi. 1998. "Scrambling and last resort", *Linguistic Inquiry* **29**: 347-366.
- Bouchard, D. 1997. "Integral minimalism", In Alexandrova, Galima M. and Olga Arnaudova (eds.) *The Minimalist Parameter*, Amsterdam Studies in the Theory and History of Linguistic Science **192**: 3-32.
- Choi, Y. and J. Yoon. 2006. "Argument Cluster Coordination and Constituency Test (Non)-Conflicts", Paper presented at NELS 37.
- \_\_\_\_\_. 2001. "The concept of 'universal' and the case of Japanese", *Lingua* **111**: 247-277.
- Karttunen, Lauri. 1989. "Radical lexicalism" In Baltin, Mark R. and Anthony S. Kroch (eds.), *Alternative Conceptions of Phrase Structure*, 43-65, University of Chicago.
- Kempson, R. and Meyer-Viol, W., and Gabby, D. 2001. *Dynamic Syntax: The Flow of Language Understanding*. Oxford:Blackwell.
- Kiaer, J. and R. Kempson. 2005. "Pro-active parsing of Korean scrambling", *WCCFL* **24**: 209-217.
- Miyagawa, S. 1997. "Against optional scrambling", *Linguistic Inquiry* **28**: 1-25.
- \_\_\_\_\_. 2003. "A movement scrambling and options without optionality" In Karimi, S (ed.) *Word Order and Scrambling*: 177-200, Oxford:Blackwell.
- Phillips, C. 2003. "Linear order and constituency", *Linguistic Inquiry* **34**,1: 37-90.
- Saito, M. 1989. "Scrambling as semantically vacuous A'-movement", In Baltin, Mark R. and Anthony S. Kroch (eds.), *Alternative Conceptions of Phrase Structure*, 182-200. University of Chicago.
- \_\_\_\_\_. 1992. "Long distance scrambling in Japanese", *Journal of East Asian Linguistics* **1**: 69-118.
- \_\_\_\_\_. 1994. "Improper adjunction", *MIT Working Papers in Linguistics* **24**: 263-293.
- \_\_\_\_\_. 2003. "A derivational approach to the interpretation of scrambling chains", *Lingua* **113**: 481-518.
- Saito, M. and N. Fukui. 1998. "Order in phrase structure and movement", *Linguistic Inquiry* **29**: 439-474.
- Uszkoreit, Hans. 1986. "Categorial unification grammars", *Proceedings of Coling 86*, Bonn: Association for Computational Linguistics, 187-194.
- Yoon, James H-S. and Woo Seung Lee. 2005. "Conjunction reduction and its consequences for noun phrase morphosyntax in Korean", *Proceedings of the 24<sup>th</sup> West Coast Conference on Formal Linguistics*.

# Gestural Alignment Constraints and Unstressed Vowel Devoicing in Andean Spanish

**Ann Marie Delforge**  
University of California, Davis

## **1. Introduction**

This paper applies the gestural alignment constraint schema proposed by Gafos (2002) to unstressed vowel devoicing in Andean Spanish. I will argue that this approach successfully addresses several characteristics identified in novel data from Cusco, Peru that depart from cross-linguistic trends in vowel devoicing and cannot be readily explained in terms of more traditional Articulatory Phonology phasing terminology. The discussion is organized as follows: Section 2 provides a description of vowel devoicing patterns in Andean Spanish and compares them with the characteristics of vowel devoicing in other languages. Section 3 develops an account of the Andean data in terms of timing patterns expressed as inter-segmental and intra-segmental gestural alignment constraints while Section 4 concludes and summarizes.

## **2. The Unusual Characteristics of Vowel Devoicing in Andean Spanish**

### **2.1 Cross-linguistic characteristics of vowel devoicing**

Vowel devoicing has been documented in a number languages including Japanese (Kondo 1997, Tsuchida 1997 and Varden 1999, *inter alia*), Korean (Jun & Beckman 1993, Jun, Beckman & Lee 1998), Modern Greek (Dauer 1980), Montreal French (Cedergren 1986) and Turkish (Jannedy 1995). Gordon (1998) presents information about vowel devoicing patterns in many less well-studied languages. In the vast majority of these cases, vowel devoicing is described as a variable, gradient and non-contrastive phenomenon that primarily affects high vowels adjacent to voiceless consonants.<sup>1</sup> The process is typically attributed to two universal phonetic properties of high vowels: their limited duration and the relatively high tongue position involved in their production. Because high vowels are inherently shorter than low or mid vowels in all

languages (Lehiste 1970), there is a greater probability that the glottal abductions of adjacent voiceless consonants will prevent full realization of the glottal adductions required for their voicing. Also, the close oral constriction associated with the production of high vowels raises air pressure in the oral cavity which inhibits transglottal air flow and therefore makes them more susceptible to devoicing than those produced with lower tongue positions (Jaeger 1978). The relationship between duration and devoicing is underscored by the fact that, in languages with contrastive vowel length, only short high vowels are affected while in languages with stress accent high vowel devoicing is limited to unstressed syllables.

Duration and aerodynamics are also the basis for two other factors that condition vowel devoicing in many languages, prosodic position and speech rate. Gordon (1998) reports that the final position of large prosodic domains is particularly conducive to devoicing, presumably due to the drop in subglottal pressure that can be expected to occur over the course of an utterance. With the notable exception of Japanese, in which vowel devoicing appears to be relatively independent of speech rate (Kondo 1997, Varden 1999), the process occurs primarily in rapid speech. This effect is attributed to the temporal compression that occurs as speech rate increases and further reduces the already short duration of high vowels, thus making them even more likely to be overwhelmed by contiguous voiceless consonants.

## 2.2 Vowel devoicing in Andean Spanish

Based on conversational speech samples collected in Cusco Peru, vowel devoicing in Andean Spanish is also a gradient and variable effect that targets vowels in unstressed syllables adjacent to voiceless consonants.<sup>2</sup> As in most other languages, the partially and completely devoiced vowels produced by this process do not contrast with fully voiced vowels. However, in this dialect, the effect is not limited to the high vowels.

Word internally (1) and in sandhi (2), the front mid-vowel /e/ is devoiced in a proportion similar to that of the high vowels /i/ and /u/.<sup>3</sup> As /e/ is a vowel of intermediate duration and is not produced with a particularly close oral constriction, its tendency to devoice in these contexts cannot be attributed to the aerodynamic and durational factors thought to drive high vowel devoicing in other languages.

|     |     |                |                     |                       |
|-----|-----|----------------|---------------------|-----------------------|
| (1) | /u/ | [kʊskéña]      | <i>Cusqueña</i>     | ‘Cusqueña brand beer’ |
|     | /i/ | [partʃsípa]    | <i>participa</i>    | ‘participates’        |
|     | /e/ | [artɕsanía]    | <i>artesanía</i>    | ‘crafts’              |
| (2) | /i/ | [káʃi tóðo]    | <i>casi todo</i>    | ‘almost all’          |
|     | /e/ | [tráxɕ típiko] | <i>traje típico</i> | ‘typical costume’     |



Furthermore, in word-final syllables closed by an /s/ (3), the majority of which are plural morphemes, all five Spanish vowels are affected to an approximately equal degree including the low vowel /a/ which should be especially resistant to devoicing as a result of its longer duration and manner of production.

|     |     |                 |                       |                 |
|-----|-----|-----------------|-----------------------|-----------------|
| (3) | /u/ | [kórpʏs kɾisti] | <i>Corpus Crisiti</i> | ‘Corpus Cristi’ |
|     | /i/ | [arkoír̥is]     | <i>arcoiris</i>       | ‘rainbow’       |
|     | /e/ | [dosént̥es]     | <i>docentes</i>       | ‘teachers’      |
|     | /o/ | [mút̥ʝos]       | <i>muchos</i>         | ‘many’          |
|     | /a/ | [alpák̥as]      | <i>alpacas</i>        | ‘alpacas’       |

The prosodic patterns associated with word final unstressed vowel devoicing in Andean Spanish also differ somewhat from cross-linguistic trends. Firstly, as unstressed vowels in this context are placed in the final position of progressively larger prosodic domains, devoicing rates actually decrease in contradiction to the tendencies observed in other languages and to expectations based on aerodynamic factors. Secondly, the syllabic affiliation of a following /s/ has a significant effect on devoicing: vowels that precede a tautosyllabic /s/ are much more likely to devoice than those that are followed by an /s/ which forms the onset of the next syllable. This statistically significant difference ( $\chi^2$   $p < .05$ ) in devoicing rates occurs both word medially (4a) and word finally when a final /s/ may become the onset of a subsequent vowel initial word (4b).

(4a) /s/ in onset: devoicing may occur but is less likely (~12% devoicing rate)

|                            |                           |                      |
|----------------------------|---------------------------|----------------------|
| [pro.f̥e.sór]              | <i>profesor</i>           | ‘teacher’            |
| [kó.s̥a.sin.te.re.sán.tes] | <i>cosas interesantes</i> | ‘interesting things’ |

(4b) /s/ in coda: devoicing is more likely (~40% devoicing rate)

|                        |                         |                  |
|------------------------|-------------------------|------------------|
| [ek.s̥j̥s.tír]         | <i>existir</i>          | ‘to exist’       |
| [kwán.t̥as.pa.lá.bras] | <i>cuantas palabras</i> | ‘how many words’ |

Finally, as in the case of Japanese, Andean vowel devoicing does not exhibit a strong correlation with speech rate. Unstressed vowels are frequently devoiced in slow, careful speech and are even affected with some regularity in text reading tasks. An analysis of the relationship between speech rate measured in syllables per second and the percentage of unstressed vowels devoiced in 560 intonation phrases yielded a Pearson Product Moment correlation coefficient of  $-.078$ , indicating that speech velocity and the frequency of vowel devoicing do not covary to a significant degree in this dialect.

### 3. Explaining Unstressed Vowel Devoicing in Andean Spanish

#### 3.1 The gestural overlap approach

High vowel devoicing was initially described as the result of a feature changing, assimilatory process by which vocalic segments were transformed from [+voice] to [-voice] in order to agree with the voicing specifications of adjacent consonants (e.g. McCawley 1968 on Japanese). However, as this approach portrays vowel devoicing as a categorical effect and fails to reflect the fact that it is often partial in nature and occurs inconsistently, more recent studies (Beckman 1994, Jannedy 1995, Jun & Beckman 1993) have employed the theoretical framework of Articulatory Phonology (Browman & Goldstein 1989 *et seq*) and attributed the process to gestural overlap.

Articulatory Phonology takes gestures, or the formation and release of constrictions in the vocal tract, to be the basic units of phonology and emphasizes the importance of their relative phasing in the production of an array of seemingly diverse, intermittently occurring phenomena associated with fast speech and casual register. For example, Browman and Goldstein (1989) used x-ray pellet studies to demonstrate that the apparent deletion of word final /t/ as in ‘perfect memory’, schwa elision and assimilations such as ‘seve[m] plus’ all result from the overlap of some articulatory gestures by others rather than from the actual deletion of gestures. When vowel devoicing is also ascribed to a rate-based decrease in the distance between articulatory gestures that causes the glottal abductions of voiceless segments to impinge upon the adduction gestures of adjoining vowels, the gradience and variability of the process, as well as its association with fast speech and its tendency to affect high and therefore short vowels are all successfully accounted for.

Vowel devoicing in Andean Spanish is incompatible with the gestural overlap approach applied to prototypical devoicing patterns in several ways. As it is occurs in slow speech when, presumably, there is ample time to produce all requisite articulatory gestures and affects non-high and therefore not particularly short vowels, it cannot be ascribed to the interaction of a rate-based decrease in the temporal distance between gestures and the duration of affected vowels. In addition, the behavior of word-final syllables ending in /s/, including the influence of /s/’s syllabic affiliation on the probability of devoicing as well as the decrease in devoicing rates that occurs when these syllables are placed in the final position of progressively larger prosodic domains, cannot easily be explained in terms of the durational or aerodynamic factors thought to motivate vowel devoicing in other languages. However, as gradience and variability are essential features of Andean vowel devoicing, it nonetheless appears that this process would be most successfully addressed by an approach that makes explicit reference to the relative timing of adjacent articulatory gestures.

### 3.2 Gestural alignment constraints

While unspecified increases in gestural overlap based on the phonetic characteristics of high vowels fail to account for vowel devoicing patterns in Andean Spanish, the gestural alignment schema recently proposed by Gafos (2002) which translates the principles of Articulatory Phonology into Optimality Theoretic terms makes it possible to explain the process as a result of gestural phasing. Gafos expresses the temporal relationships between gestures with greater precision than previous AP representations through reference to a set of hypothetical “landmarks”, or points at which one gesture can be coordinated with another (5), and by formulating phasing as an alignment constraints of the type initially proposed by McCarthy and Prince (1993) as shown in (6). Based on phasing relationships previously discussed by Browman and Goldstein, Gafos indicates that coordination constraints also govern the relationship between vowels and consonants (CV COORD and VC COORD) and between vowels (VV COORD).

(5) Gafos’ Gestural Landmarks

(6) ALIGN ( $G^1$ , landmark<sup>1</sup>,  $G^2$ , landmark<sup>2</sup>):  
Align landmark<sup>1</sup> of  $G^1$  to landmark<sup>2</sup> of  $G^2$

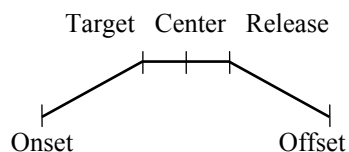

The greater specificity of constraints composed according to this schema permits the expression of fine-grained non-contrastive differences in gestural phasing between languages and dialects which, although minute, have significant acoustic consequences, being the type of distinctions that make “English sound like English and German sound like German” (Ladefoged 1980). And, of course, as no faithfulness constraints need be proposed in an analysis consisting of output oriented alignment constraints, it is possible to refer to a wide range of phonetic detail without predicting the existence of unattested contrasts (Kirchner 1997).

Gafos discusses cross-linguistic disparities in the relative timing of consonant clusters, developing different potential consonant to consonant coordination relationships, expressed as variants of CC COORD, which model the phasing of consonant clusters in languages that allow for close transitions without acoustic release and in those that require more open transitions with the first element in a cluster being released in order to maximize perceptibility. He reports that, in simulations carried out using the GEST computational model, these hypothetical relationships did indeed produce the expected acoustic results.

Evidence suggesting that VV configurations may be language specific comes from an x-ray pellet study conducted by Smith (1993) couched in more traditional AP phasing terminology. The results of this experiment revealed vowel to vowel coordination differences between Italian and Japanese

interpreted by the author as reflecting the difference between syllable-timed and mora-timed languages.

Given these precedents, I propose CV and VC COORD may also exhibit cross-linguistic variation and that unstressed vowel devoicing in Andean Spanish can be effectively modeled by assuming that the CV and VC COORD relationships present in this dialect allow for greater than typical overlap between adjacent consonant and vowel gestures. As it has been suggested that, unlike the majority of Spanish dialects which are described as syllable-timed, Andean varieties may be stressed-timed (Hundley 1986). It is possible that these more overlapped consonant-vowel phasing relationships are typical of the later speech rhythm type.

Of course, static coordination relationships cannot adequately represent the gradient nature of devoicing or the fact that unstressed vowels are most often produced as fully voiced in Andean Spanish. In order to accurately model the process, CV and VC COORD will be expressed in terms of phase windows (Byrd 1996) which allow a range of points within one gesture's cycle to be phased with another gesture. (7) illustrates the canonical CV and VC coordination relationships proposed by Browman and Goldstein represented in Gafos' formalism while (8) depicts hypothetical CV and VC COORD constraints for Andean Spanish expressed in terms of ranges associated with phase windows. The least overlapped relationships allowed by these windows correspond to the canonical phasing schemes in (7) and thus account for the occurrence of fully voiced unstressed vowels. (9) shows phasing relationships that would either violate or satisfy these hypothetical constraints, with the edges of the phase windows represented by bold vertical lines. (9a) and (9c) satisfy CV and VC COORD, respectively, and produce devoiced vowels. (9b) and (9d), on the other hand, both satisfy the relevant alignment constraints for Andean Spanish and represent the canonical configurations shown in (7), thus producing fully voiced vowels.

(7) Canonical CV, VC Coordination: (Browman & Goldstein 1990; Gafos 2002)

**CV COORD:** ALIGN (Center C, Onset V)

**VC COORD:** ALIGN (Release V, Target C)

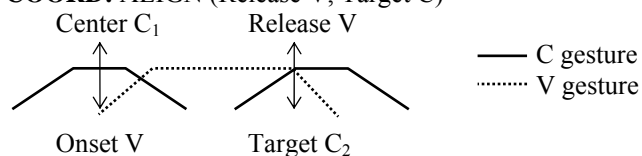

(8a) **CV COORD<sub>A</sub>:** ALIGN (Onset ~ Center C, Onset V)

V Onset may align with any point ranging from Onset to Center in C

(8b) **VC COORD<sub>A</sub>:** ALIGN (Target ~ Release V, Target C)

C Target may align with any point ranging from Target to Release in V

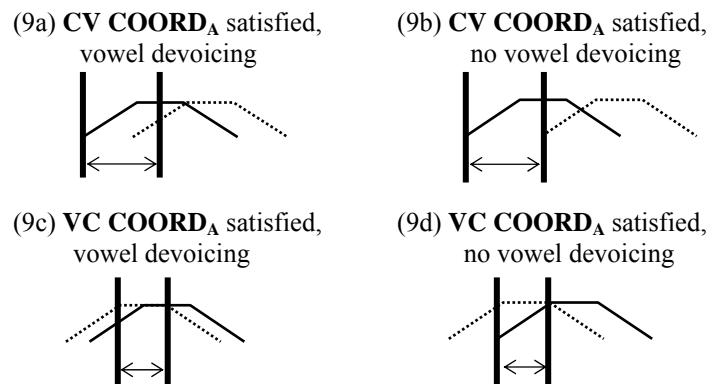

### 3.3 The devoicing of /e/: consonant-vowel homorganicity

As the reader will recall, only the high vowels /i/ and /u/ and the front mid-vowel /e/ are devoiced word internally and in sandhi. Given that the mean durations of the /e/ and the other mid-vowel /o/ are 58.82 and 58.95 milliseconds respectively (Marín Gálvez 1994), intrinsic length cannot account for the difference between the devoicing rates for these two vowels and some other factor must interact with CV and VC **COORD<sub>A</sub>** to produce this pattern.

Given that a study of phoneme frequency in conversational speech (Quilis & Esgueva 1980) indicates that the most commonly occurring voiceless consonants in Spanish are the coronals /s/ and /t/, the characteristic that sets /e/ apart from the other high vowels and underlies its tendency to devoice may be its anterior place of articulation. Clements and Hume's (1995) conclusion, based on consonant-vowel interactions in a variety of languages, that front vowels appear to form a natural class with coronal consonants and should therefore be considered [+coronal] supports the speculation that the high devoicing rate of /e/ is a result of this anterior vowel's interaction with voiceless consonants articulated in the same general region of the oral cavity. Furthermore, Lipski's (1990) feature geometry account of unstressed vowel reduction in Andean Spanish specifically attributes the frequent devoicing of /e/ to its [+coronal] status and consequent articulatory similarity to /s/.

The idea that the degree of similarity between adjacent segments may influence their relative phasing is quite compatible with Gafos' model. In his (2002) analysis of Colloquial Moroccan Arabic, he notes that the same CC **COORD** relationships produce different acoustic outcomes when the two consonants involved are homorganic rather than heterorganic. In her study of svarabhakti phenomena conducted within Gafos' gestural alignment framework, Hall (2004) proposes that, since consonant-vowel homorganicity affects the occurrence of vowel fragments in some languages and influences the probability of metathesis in others, gestural overlap is more limited in heterorganic consonant-vowel

combinations than in homorganic pairs. Following this line of reasoning, I propose that /e/ is more frequently devoiced than /o/ as a result of the greater degree of overlap permitted between this front vowel and homorganic (coronal) voiceless consonants. This hypothesis is expressed in the constraint  $*\text{OVERLAP V//C}_{\text{HET}}$  shown in (10). As shown in (10a), this constraint allows coronal consonants to overlap the front vowel /e/ sufficiently to cause devoicing. However, the same degree of overlap between coronal consonants and the back vowel /o/ (10c) results in a violation of  $*\text{OVERLAP V//C}_{\text{HET}}$ .

(10)  $*\text{OVERLAP V//C}_{\text{HET}}$ : The plateau of a consonant may not overlap the plateau of an adjacent heterorganic vowel.

(10a)  $*\text{OVERLAP}_{\text{HET}}$  satisfied

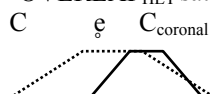

(10b)  $*\text{OVERLAP}_{\text{HET}}$  satisfied:

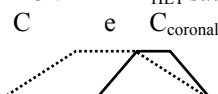

(10c)  $*\text{OVERLAP}_{\text{HET}}$  violated

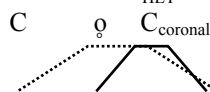

(10d)  $*\text{OVERLAP}_{\text{HET}}$  satisfied

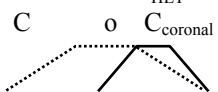

Tableaux 1 through 3 illustrate the interaction of  $*\text{OVERLAP V//C}_{\text{HET}}$  with CV and VC  $\text{COORD}_A$ . In the first tableau, we see that many different degrees of overlap permitted by CV and VC  $\text{COORD}_A$ , illustrated by candidates (a), (b) and (c) fail to violate  $*\text{OVERLAP V//C}_{\text{HET}}$  since /e/ and the surrounding consonants are homorganic. Only Candidate (d) is ruled out because its overlap is insufficient to satisfy CV  $\text{COORD}_A$  and VC  $\text{COORD}_A$ .

**Tableau 1. Overlap and the unstressed mid-vowel /e/**



| /sesánte/<br>'retired'                                                                              | $*\text{OVERLAP}_{\text{HET}}$<br>V//C | CV<br>$\text{COORD}_A$ | VC<br>$\text{COORD}_A$ |
|-----------------------------------------------------------------------------------------------------|----------------------------------------|------------------------|------------------------|
| a. <br>[sɛsánte] |                                        |                        |                        |
| b. <br>[sesánte] |                                        |                        |                        |
| c. <br>[sesánte] |                                        |                        |                        |
| d. <br>[sesánte] |                                        | *!                     | *                      |

Tableau 2, on the other hand, shows that the only candidate produced with a degree of overlap sufficient to produce devoicing, candidate (a), runs afoul of  $*\text{OVERLAP}_{\text{HET}} \text{V//C}$  because  $\text{C}_2$ 's plateau overlaps the vowel's plateau and the two sounds are heterorganic. Candidates (b) and (c) with voiced /o/ both satisfy all coordination constraints. Voiced Candidate (d), on the other hand, is ruled out by  $\text{CV COORD}_A$  and  $\text{VC COORD}_A$  due to insufficient overlap.

**Tableau 2. Overlap and the unstressed mid-vowel /o/**

| /esotériko/<br>'esoteric'                                                                            | $*\text{OVERLAP}_{\text{HET}} \text{V//C}$ | $\text{CV COORD}_A$ | $\text{VC COORD}_A$ |
|------------------------------------------------------------------------------------------------------|--------------------------------------------|---------------------|---------------------|
| a. <br>[esotériko]  | *!                                         |                     |                     |
| b. <br>[esotériko]  |                                            |                     |                     |
| c. <br>[esotériko]  |                                            |                     |                     |
| d. <br>[esotériko] |                                            | *!                  | *                   |

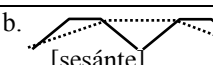
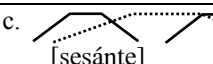
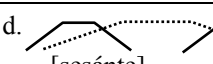
Finally, in Tableau 3, we see that the interaction between vowel duration and the CV, VC coordination constraints is sufficient to cause the devoicing of high vowels:

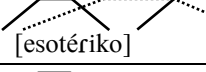
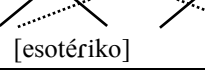
**Tableau 3. Overlap and the unstressed high vowels**

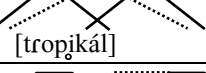
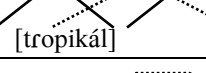
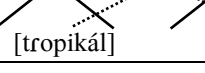
| /tropikál/<br>'tropical'                                                                             | $*\text{OVERLAP}_{\text{HET}} \text{V//C}$ | $\text{CV COORD}_A$ | $\text{VC COORD}_A$ |
|------------------------------------------------------------------------------------------------------|--------------------------------------------|---------------------|---------------------|
| a. <br>[tropikál] | *!                                         |                     |                     |
| b. <br>[tropikál] |                                            |                     |                     |
| c. <br>[tropikál] |                                            |                     |                     |
| d. <br>[tropikál] |                                            | *!                  | *                   |

Devoiced candidate (a) is ruled out by  $*\text{OVERLAP}_{\text{HET}} \text{V//C}$  because the front vowel /i/ is located between two non-coronal consonants in this example. However, due to the limited duration of /i/ a devoiced candidate (b) can be

produced by a lesser degree of overlap which does not violate \*OVERLAP. Voiced candidate (c) is also acceptable to all constraints but candidate (d) is eliminated because the overlap between the vowel and the adjacent consonants is insufficient to satisfy CV and VC COORD<sub>A</sub>. No tableau for the low vowel /a/ is provided due to space considerations. However, it is assumed that /a/ would pattern like /o/, with any candidate sufficiently overlapped to produce devoicing being eliminated due to violations of \*OVERLAP.

### 3.4 Intra-segmental coordination and the coda /s/ effect

The reader will recall that all vowels, including the back mid-vowel /o/ and the low vowel /a/, are frequently devoiced in word final syllables closed by /s/. Since, under the present analysis, \*OVERLAP<sub>HET</sub> V//C prevents coronal voiceless consonants from overlapping these non-front vowels to the extent that would cause devoicing, this pattern requires further explanation.

It seems plausible that the high devoicing rate in this context is due to the articulatory characteristics of coda /s/ rather than in the effects of word final position or morphological factors, despite the fact that the majority of word-final syllables ending in /s/ are plural desinences. Evidence supporting the role of coda /s/ in this devoicing pattern comes from the finding reported in Section 2.2 that unstressed vowels followed by an /s/ in coda rather than in the onset position of the following syllable are significantly more likely to be devoiced word internally as well as word finally.

The asymmetry between devoicing rates associated with coda /s/ and /s/ in onset can plausibly be attributed to the articulatory pattern known as the syllable position effect. Several studies on English nasals, stops and the lateral /l/ (reviewed in Krakow 1999) have shown that these consonants exhibit a different type of organization when in coda; the timing relationships between their component gestures becomes less stable and there is an overall tendency for secondary articulatory gestures, such as movements of the velum, tongue dorsum or changes in glottal aperture to occur earlier in relation to the sounds' primary oral gesture than when in onset position. As vocal fold abduction normally occurs simultaneously with /s/'s oral gesture (Silverman 1997), the syllable position effect might cause a regressive shift in the sound's glottal opening and thus devoice the preceding unstressed vowel, as in (11a).

Evidence in favor of this explanation comes from the decline in devoicing rates that occurs as word-final syllables ending in /s/ are placed in the final position of progressively larger prosodic domains. It seems reasonable to attribute this decrease in devoicing to phrase final lengthening, or the stretching out and pulling apart of articulatory gestures that has been observed at the boundaries of larger prosodic units (Beckman, Edwards & Fletcher 1992). Such a lengthening of gestures could counteract the syllable position effect by increasing the duration of vowels and moving them farther away from the glottal opening



associated with /s/, therefore preventing their devoicing at the ends of intonational phrases and utterances (11b).

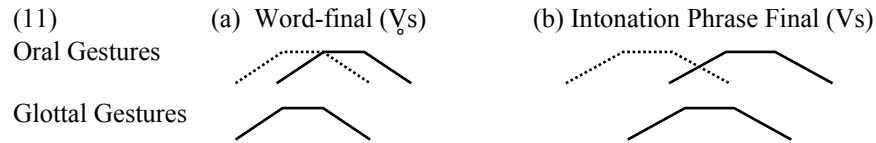

As the syllable position effect may not occur in all languages and its specific characteristics appear to exhibit cross-linguistic variation (Kochetov 2006), it is appropriately expressed in terms of coordination constraints. However, in this case, the constraints must refer to intra-segmental rather than inter-segmental gestural coordination. While Gafos does not propose any intra-segmental level constraints, he does lay the groundwork for them by noting that the primary oral gesture of a sound should be considered its ‘head’ gesture with which all other component gestures must be phased. Based on this proposal, HS COORD (12a) expresses the default coordination relationship between the head and secondary gestures associated with a segment. Presumably, in the case of /s/, this relationship would be one of simultaneity as shown in (13a). OG-COORD<sub>CODA</sub> (12b) represents a head-secondary gesture relationship that might be associated with the syllable position effect. In (13b), we see that this constraint is satisfied when the secondary, glottal opening gesture precedes the head gesture. As in the case the constraints expressing inter-segmental coordination, OG-COORD<sub>CODA</sub> is formulated in terms of a phase window in order to accurately represent the gradience and variability of the devoicing process. It is assumed that, in Andean Spanish, OG-COORD<sub>CODA</sub> outranks HS-COORD.

(12a) HS-COORD: Within a segment, align the onset of the head (oral) gesture with the onset of the secondary gesture (default scheme)

(12b) OG-COORD<sub>CODA</sub>: Within a segment associated with coda position, align the onset of the oral gesture with a point within the phase window {1τ before the target ~ center} of the glottal gesture (context-specific coordination scheme)<sup>4</sup>

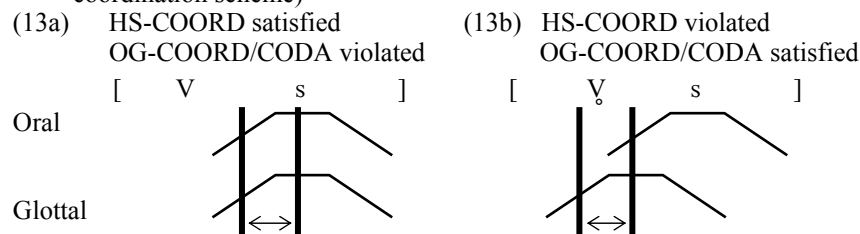

In Tableau 4, we see how OG-COORD<sub>CODA</sub> causes the devoicing of /o/ in a word final syllable. In candidates (a), (b) and (c), adjacent voiceless coronal

consonants overlap the vowel sufficiently to cause devoicing, rendering the intra-segmental coordination of the following /s/ irrelevant. However, as all three violate  $*OVERLAP_{HET}$ , they are ruled out. Voiced candidate (d) has acceptable inter-segmental relationships, but is eliminated as it violates  $OG-COORD_{CODA}$ . Candidates (e) and (f) are co-optimal, with (e) producing devoiced vowel due to the early glottal opening gesture of the following /s/ and (f) producing an acceptable voiced vowel. In the later case, /s/'s glottal gesture is within the phase window of  $OG-COORD_{CODA}$  but still far enough away from the vowel to allow glottal adduction to occur.

**Tableau 4. Devoicing of word-final /o/**

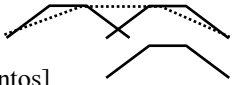
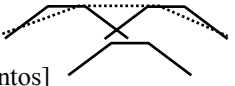
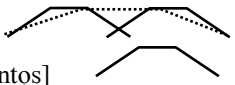
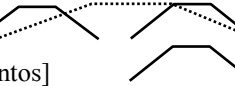
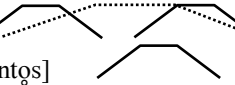
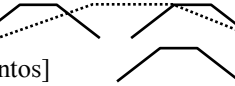
| /púntos/<br>'stitches'                                                                             | $*OVERLAP_{HET}$<br>V//C | CV<br>COORD <sub>A</sub> | VC<br>COORD <sub>A</sub> | OG<br>COORD <sub>COD<sub>A</sub></sub> | HS<br>COORD |
|----------------------------------------------------------------------------------------------------|--------------------------|--------------------------|--------------------------|----------------------------------------|-------------|
| a. <br>[púntos]  | *!                       |                          |                          | *                                      |             |
| b. <br>[púntos] | *!                       |                          |                          |                                        | *           |
| c. <br>[púntos] | *!                       |                          |                          |                                        | *           |
| d. <br>[púntos] |                          |                          |                          | *!                                     |             |
| e. <br>[púntos] |                          |                          |                          |                                        | *           |
| f. <br>[púntos] |                          |                          |                          |                                        | *           |

## 4. Conclusion

To summarize, Gafos' (2002) gestural alignment scheme successfully accounts for vowel devoicing patterns in Andean Spanish that are not explained by the interaction of rate-based decreases in the temporal distance between gestures and vowel duration. Constraints formulated in this manner seem well adapted to facilitate the explanation of acoustically salient but non-contrastive cross-linguistic differences within an OT framework.

## Notes

<sup>1</sup> According to Gordon (1998), voiceless and voiced vowels appear to contrast in Oromo, Woleaian and Hupa.

<sup>2</sup> For the present study, 16,581 unstressed vowels (1,648 devoiced) in ten minute samples of conversational speech selected from individual interviews with 16 residents of Cusco Peru (14 men, 2 women) ranging in age from 25 to 90 were examined via spectrographic analysis.

<sup>3</sup> In Spanish, /i/ and especially /u/ are very rarely found in absolute word final position. In this corpus, no occurrences of /u/, voiced or devoiced were encountered in sandhi.

<sup>4</sup> Gafos proposes  $\tau$ , the distance corresponding to half the plateau of a gesture, as "the minimal unit of temporal distance to be employed in the gradient evaluation of coordination constraints" (279).

## References

- Beckman, Mary, Jan Edwards & Jan Fletcher. 1992. "Prosodic structure and tempo in a sonority model of articulatory prominence", In G. Docherty & D. Ladd (eds.) *Papers in Laboratory Phonology II: Gesture, Segment, Prosody*. 68-86. Cambridge: Cambridge University Press.
- Browman, Catherine & Louis Goldstein. 1989. "Articulatory gestures as phonological units", *Phonology*, **6**:201-251.
- Byrd, Dani. 1996. "A phase window framework for articulatory timing", *Phonology*, **13**:139-169.
- Cedergren, Henrietta. 1986. "Metrical structure and vowel deletion in Montreal French", In David Sankoff, (ed.) *Diversity and Diachrony*. 293-300. Amsterdam: John Benjamins.
- Clements, G. N. & Elizabeth Hume. 1995. "The internal organization of speech sounds", In John Goldsmith, (ed.) *The Handbook of Phonological Theory*. 245-306. Cambridge MA, Blackwell.
- Dauer, Rebecca. 1980. "The reduction of unstressed high vowels in Modern Greek", *Journal of the International Phonetic Association* **10**:17-27.
- Gafos, Adamantios. 2002. "A grammar of gestural coordination", *Natural Language and Linguistic Theory*, **20**:269-33.
- Gordon, Matthew. 1998. "The phonetics and phonology of non-modal vowels: A cross-linguistic perspective", *Proceedings of the Berkeley Linguistic Society* **24**:93-105.
- Hall, Nancy. 2004. "Implications of vowel intrusion for a gestural grammar" Ms. University of Haifa.

- Hundley, James. 1986. "The effects of two phonological processes on syllabic structure in Peruvian Spanish", *Hispania*, **69**: 665-668.
- Jaeger, Jeri. 1978. "Speech aerodynamics and phonological universals", *Proceedings of the Berkeley Linguistic Society*, **4**:311-329.
- Jannedy, Stefanie. 1995. "Gestural phasing as an explanation for vowel devoicing in Turkish", *OSU Working Papers in Linguistics*, **45**:56-84.
- Jun, Sun-Ah & Mary Beckman. 1993. "A gestural-overlap analysis of vowel devoicing in Japanese and Korean", Paper presented at the 67<sup>th</sup> Annual Meeting of the Linguistic Society of America, Los Angeles, CA.
- Jun, Sun-Ah, Mary Beckman, and Lee, H. 1998. Fiberscopic evidence for the influence on vowel devoicing of the glottal configurations for Korean obstruents. *UCLA Working Papers in Phonetics*, **96**.
- Kirchner, Robert. 1997. "Contrastiveness and faithfulness", *Phonology*, **14**:83-111.
- Kondo, Mariko. 1997. *Mechanisms of Vowel Devoicing in Japanese*. PhD Dissertation, University of Edinburgh.
- Kochetov, Alexei. 2006. "Syllable position effects and gestural organization: Articulatory evidence from Russian", In Louis Goldstein, Douglas Whalen, & Catherine Best, (eds.) *Papers in Laboratory Phonology VIII*. 565-588. The Hague, Mouton de Gruyter.
- Krakow, Rena. 1999. "Physiological organization of syllables: A Review", *Journal of Phonetics*, **27**:23-54.
- Ladefoged, Peter. 1980. "What arevlinguistic sounds are made of?", *Language*, **56**:485-502.
- Lehiste, Ilse. 1970. *Suprasegmentals*. MIT Press, Cambridge, MA.
- Lipski, John. 1990. "Aspects of Ecuadorian vowel reduction", *Hispanic Linguistics*, **4**:1-19.
- Marín Gálvez, Rafael. 1994. "La duración vocálica en español", *E.L.U.A.*, **10**:213-226.
- McCarthy, John J. & Alan Prince. 1993. "Generalized alignment", In Geert Booij and Jan van Marle (eds.), *Yearbook of Morphology*. Kluwer, Dordrecht, 79-153.
- Quilis, Antonio and Manuel Esgueva. 1980. "Frecuencia de fonemas en el español hablado", *Lingüística Español Actual*, **2**:1-25.
- Silverman, Daniel. 1997. *Phrasing and Recoverability*. Garland Press, New York.
- Smith, Caroline. 1993. "Prosodic patterns in the coordination of consonant and vowel gestures", In Bruce A Connel & Amalia Arvaniti(eds.) *Papers in Laboratory Phonology IV: Phonology and Phonetic Evidence*. Cambridge, Cambridge University Press, 205-222.
- Tsuchida, Ayako. 1997. *The phonetics and phonology of Japanese vowel devoicing*. Ph.D. dissertation, Cornell University.
- Varden, John Kevin. 1999. *On high vowel devoicing in Standard Modern Japanese: implications for current phonological theory*. Ph.D. dissertation, University of Washington.

Ann Marie Delforge  
 Department of Spanish and Classics  
 University of California, Davis  
 One Shields Avenue  
 Davis, CA 95616, USA  
 amdelforge@ucdavis.edu

# The Syntax of Telicity in Vietnamese\*

**Shin Fukuda**

University of California, San Diego

## 1. Introduction

Vietnamese is an SVO language with isolating morphology, no morphological case marking, *wh*-in-situ, and a rich classifier system. As an SVO language, objects follow the verbs that subcategorize for them. While a verb and its object are normally adjacent, there is a group of particles that can intervene between them.

- (1) a. Lan    tìm    hai    quyển   sách<sup>1</sup>  
 Lan    search   two    CL        book  
 ‘Lan looked for two books.’
- b. Lan    tìm    **ra**    hai    quyển   sách  
 Lan    search   T-PART   two    CL        book  
 ‘Lan found two books.’
- (2) a. Tân    đọc    hai    quyển   sách  
 Tân    read   two    CL        book  
 ‘Tân read two books.’
- b. Tân    đọc    **xong/hết**    hai    quyển   sách  
 Tân    read   T-PART/T-PART   two    CL        book  
 ‘Tân has read two books.’

These particles are interesting for several reasons. Syntactically, they appear to form constituents with objects, as they can be coordinated.

- (3) Lan tìm [ra sách đó]    nhưng [không ra từ điển]  
 Lan search [T-PART book that]    but [NEG T-PART dictionary]  
 ‘Lan found the book but not the dictionary.’

There are also restrictions on the positions of these particles with respect to objects. Quantified NPs (i.e. NPs with a classifier phrase) and some bare NPs

can be either preceded or followed by these particles (4). With some other bare NPs, however, these particles must follow them (5).

- (4) a. Kim mở (ra) cửa (ra)  
 Kim open (T-PART) door (T-PART)  
 ‘Kim opened (the) door.’
- b. Lan bày (xong) hai trăm bức tranh (xong)  
 Lan display T-PART two hundred CL picture T-PART  
 ‘Lan finished displaying two hundred pictures.’
- (5) a. Lan bày (\*xong) tranh xong  
 Lan display T-PART picture T-PART  
 ‘Lan finished displaying pictures.’
- b. Lan cắt (\*ra) cỏ ra  
 Lan cut T-PART grass T-PART  
 ‘Lan cut grass.’

Semantically, the presence of these particles induce a telic interpretation of events, as seen in the contrast between the *a* examples and *b* examples in (1) and (2). In (1b), an atelic verb *tìm* ‘search’ denotes a telic event with an addition of the particle *ra*, creating an event whose appropriate English translation seems to be *find*. Thus, once the particle is present, a time interval adverbial ‘for X-time’ is ungrammatical (6). For this reason, I refer to these as *telic particles*.

- (6) Lan tìm ra hai quyển sách (\*trong một giờ)  
 Lan search T-PART two CL book (\*for one hour).  
 ‘Lan found two books (\*for one hour).’

Telic particles’ syntactic distribution and semantic effect have been reported in Duffield (1998, 1999), where he suggested two analyses. In one of the analyses, *the small clause analysis*, a telic particle forms a constituent with an object under the main verb (7a) (Duffield 1998).<sup>2</sup> In the other, *the functional projection analysis*, telic particles head a functional projection above VP, with the main verb raising to a position yet higher than telic particles (7b) (Duffield 1999).

- (7) a. [<sub>VP</sub> V [<sub>SC</sub> NP T-PART]]  
 b. [<sub>VP</sub> V<sub>I</sub>+Y [<sub>XP</sub> T-PART [<sub>VP</sub> V<sub>I</sub> NP]]]

In this paper, I present novel evidence for the functional projection analysis and argue that the projection of telic particles is best analyzed as an instance of *aspect phrase* located between *vP* and *VP*, where aspectual information about events are syntactically encoded (Travis 1991).<sup>3</sup>

## 2. The small clause analysis

### 2.1 Arguments for the small clause analysis

Under the small clause analysis, an object and a telic particle together form a small clause under the matrix verb.

(8) [VP V [sc NP T-PART]]

A clear conceptual advantage of the small clause analysis over the functional projection analysis is that the surface word order directly reflects the base-generated positions of the elements in the former. The empirical motivation for the small clause analysis comes from a causative construction in Vietnamese. One of the causative constructions in Vietnamese involves either the causative verb *làm* 'make' or a verb of physical contact, i.e. *đánh* 'hit', followed by an object and a verb predicated of the object (Kwon 2004). Interestingly, the word order of the object and the second verb can be altered (Duffield 1998).

- (9) a. Tân làm trà ngọt  
Tân make tea sweet
- b. Tân làm ngọt trà  
Tân make sweet tea  
'Tân made tea sweet.'

Duffield (1998) analyzes the object and the second verb to form a constituent under the main verb, and the word order alternations derive from the embedded verb incorporating into the main verb

(10) Tân làm+ngọt<sub>i</sub> [trà ngọt<sub>i</sub>]

The causative construction and the 'telic particle-object' complexes share certain similarities. Both the causative construction and the 'telic particle-object' complexes allow for the word order alternations. Also, they both create a telic interpretation of events. If the small clause analysis of the causative construction is extended to the 'telic particle-object' complexes, the '*verb-telic particle-object*' word order can be derived from the incorporation of a telic particle into the main verb.

(11) [VP V+ T-PART<sub>i</sub> [sc NP T-PART<sub>i</sub>]]

## 2.2 Arguments against the small clause analysis

Despite the initial plausibility of the small clause analysis of the ‘telic particle-object’ complexes, there are reasons to believe that the causative construction and the ‘telic particle-object’ complexes are very different, and the small clause analysis should not be extended to ‘telic particle-object’ complexes. First, while the word order alternations with telic particles and objects are limited to certain NPs ((4) and (5)), the grammaticality of the word order alternations with the causative construction depends on the embedded verbs. Only when the embedded verb denotes a result-state, the alternation is possible (Duffield 1998).

- (12) a. Tân làm Lan khóc  
 Tân make Lan cry
- b. \*Tân làm khóc Lan  
 Tân make cry Lan  
 ‘Tân made Lan cry.’

Second, even when the embedded verb in the causative construction denotes a result-state of the object, there still is an important difference between the ‘telic particle-object’ complexes and the causative construction. Unlike the embedded verb in the causative construction which denotes the object’s state, telic particles create telic events from atelic events. Thus, telic particles are not predicated of objects and tell us nothing about their states. The telic particle *ra* in (13) below, therefore, provides no information about the state of the object, the *job*.

- (13) Lan tìm ra việc  
 Lan search T-PART job  
 ‘Lan found a job.’

Third, for unknown reasons, the negative marker *không* cannot precede the causative construction, although it can appear inside of it (14). The negative marker can precede a telic particle-object complex (15).

- (14) a. \* Tân làm không [SC trà ngọt]/[SC ngọt trà]  
 Tân make NEG [SC tea sweet]/[SC sweet tea]
- b. Tân làm [SC trà không ngọt]  
 Tân make [SC tea NEG sweet]  
 ‘Tân made tea not sweet (intended).’
- (15) Dũng ăn không [hết quả táo]  
 Dũng eat NEG [T-PART CL apple]  
 ‘Dũng ate the apple without finishing it.’



These data suggest that the causative construction and the ‘telic particle-object’ complexes are different from each other both semantically and syntactically. Thus, they should not be analyzed to have the same structure.

### 3 The functional projection analysis

In the functional projection analysis, telic particles head a projection above VP, and the word order is derived via movement of the main verb to a functional projection yet higher than the projection of telic particles (Duffield 1999).

(16)  $[_{VP} \quad V_i + Y [_{XP} \quad T\text{-PART} [_{VP} \quad V_1 \quad NP]]]$

In this section, I first show that the semantic characteristics and syntactic distribution of telic particles are consistent with the structure proposed in the functional projection analysis. I then introduce an additional argument for the functional projection analysis from a construction that creates inchoatives from statives, which involves one of the telic particles, *ra*.

#### 3.1. Interpretation

Under the structure proposed in the functional projection analysis, telic particles dominate VP (16). This structural assumption is consistent with the interpretation of telic particles, that they add telicity to otherwise atelic events.

#### 3.2. Verb raising

In the functional projection analysis, the main verb rises to a position that is higher than telic particles, deriving ‘verb-telic particle-object’ word order. In Duffield (1998), this line of analysis was rejected based on an assumption that the verb raising cannot be motivated for Vietnamese (ibid: 104). On the contrary, there exists independent evidence for verb raising in Vietnamese. A manner adverb such as *nhanh chóng* ‘quickly’ can intervene between a verb and its object, suggesting that the main verbs in Vietnamese move out of VP.<sup>4,5</sup>

(17) 

|                                          |         |                    |      |      |     |         |
|------------------------------------------|---------|--------------------|------|------|-----|---------|
| Chúng nó                                 | bày     | <b>nhanh chóng</b> | năm  | mười | bức | tranh   |
| They                                     | display | quickly            | five | ten  | CL  | picture |
| ‘They quickly displayed fifty pictures.’ |         |                    |      |      |     |         |

Assuming verb raising takes place in Vietnamese, the functional projection analysis predicts that a manner adverb may also occur between a telic particle and an object, since a ‘stranded object’ alone may represent the remnant VP under the analysis. This prediction is borne out by (18).

- (18) Tân tìm<sub>i</sub> ra [VP' **nhanh chóng** [VP t<sub>i</sub> [các chương trình]]]  
 Tân search<sub>i</sub> T-PART [VP' quickly [VP t<sub>i</sub> [all program]]]  
 'Tân found quickly all the programs.'

Moreover, with a raised main verb, the constituency fact in (3) can be analyzed as an instance of across-the-board extraction of the main verb, as in (19).

- (19) Lan tìm<sub>i</sub> [t<sub>i</sub> ra sách đó] nhưng [không t<sub>i</sub> ra từ điển]  
 Lan search[ t<sub>i</sub> T-PART book that] but [NEG t<sub>i</sub> T-PART dictionary]  
 'Lan found the book but not the dictionary.'

Finally, the negation fact in (15) can also be accounted for, with the assumption that the negative marker *không* adjoins to the projection of telic particles.<sup>6</sup>

- (20) [VP Dững [Y' ăn<sub>i</sub> [**không** [XP hết [VP t<sub>i</sub> quả táo]]]]]  
 [VP Dững [Y' eat<sub>i</sub> [NEG [XP T-PART [VP t<sub>i</sub> CL apple]]]]]  
 'Dững ate the apple without finishing it.'

### 3.3. Stative-inchoative alternation: an additional argument

There is an additional set of data which provides further support for the functional projection analysis. In Vietnamese, stative predicates are simply concatenated with an NP (21a). Interestingly, when stative predicates are combined with the telic particle *ra*, the resulting sentence denotes an inchoative event. In this inchoative construction, *ra* must follow the stative predicate (21b).

- (21) a. Kim đẹp/béo/giàu  
 Kim pretty/fat/ rich  
 'Kim is pretty/fat/ rich.'
- b. Kim (\*ra) giàu ra  
 Kim (\*T-PART) rich T-PART  
 'Kim became rich'

Given a clear similarity between the inchoative construction and the instances of telic particles with transitive predicates — namely, telic particles create telic events from atelic events/situations in both — a unified account is desirable. Under the small clause analysis, (21b) would require a structure like (22), in which *giàu* 'rich' is the matrix predicate and *Kim* and *ra* form a small clause complement of *giàu*, with *Kim* raising to be the matrix subject.

- (22) Kim<sub>i</sub> giàu [sc ~~Kim~~<sub>i</sub> ra]

(22) is quite problematic, however, as the predicate denoting the result-state, *giàu* ‘rich’, dominates the predicate providing the inchoative meaning, *ra*. It is not clear how the appropriate interpretation can be derived from this structure, given the common assumption that an inchoative event derives from the inchoative component of the meaning operating on a state, not vice versa (i.e. Dowty 1979). Under the functional projection analysis of telic particles, on the other hand, *ra* would be the head of the functional projection above the projection of the stative predicate, with *Kim* as the embedded subject. The stative predicate would raise to the head position of a projection higher than that of *ra*, with the embedded subject *Kim* also raising to become the matrix subject.

(23) Kim<sub>i</sub> đep<sub>j</sub> [<sub>XP</sub> ra [<sub>VP/AP</sub> Kim<sub>i</sub> đep<sub>j</sub>]]

Thus, applying the functional projection analysis to the inchoative construction enables us to postulate a more plausible structure for the construction, in which the inchoative predicate dominates the result-state predicate. More importantly, the functional projection analysis enables us to account for the instances of telic particles with transitive verbs and the inchoative construction in a unified way.

Thus, unlike the small clause analysis, which is only consistent with some of the data, the functional projection analysis has been shown to be consistent with and supported by the original data as well as the additional data from the verb raising and inchoative construction. In the rest of the paper, therefore, I pursue the functional projection analysis of telic particles.

#### 4. *Aspect phrase in Vietnamese*

Thus far, our analysis of telic particles suggests that there are two functional projections above VP in a Vietnamese sentence: one that is headed by telic particles, and the other that is the landing site for the raising main verbs. In this section, I first argue that the landing site for the rising main verbs is *v*, based on the distribution of elements around the surface position of the main verb. Second, given this analysis, as well as the unique semantic effect of telic particles, I argue that the functional projection of telic particles is *aspect phrase*, where aspectual information of events are syntactically encoded (Travis 1991).

##### 4.1. *V-to-v movement in Vietnamese*

If Vietnamese main verbs move to a position that is higher than the projection of telic particles, an obvious question is where main verbs move to. Elements occurring in the vicinity of the main verb help us determine the main verb's position. First, there are several elements that must precede the main verb in a

Vietnamese sentence: (i) view-point aspect markers, such as *đã* ‘perfective’; (ii) modals, such as *phải* ‘must’; and (iii) the subject-oriented element, *tự* ‘self’.

- (24) Lan đã (phải) **tự** tìm (\*đã) (\*phải) (\*tự) ra việc  
 Lan PERF (must) self search (\*PERF) (\*must) (\*self) T-PART job  
 ‘Lan found the job by herself.’

For the purpose of this study, I assume that view-point aspect markers and the modals head their own projections. Under this assumption, the linear order in (24) shows that Vietnamese main verbs land in the position that is lower than the projections of view-point aspect and modals. Within the standard assumptions about phrase structure in the *Minimalist Program*, such an intermediate projection would be *vP* or *VoiceP* (Kratzer 1994, 1996, Chomsky 1995).

In fact, the distribution of the third element, *tự* ‘self’, suggests that *v* is indeed the landing site of Vietnamese main verbs. As can be seen in (25) below, *tự* is grammatical only when a sentence denotes an event. It is ungrammatical with locative verb *ở* ‘be’ or stative predicates such as *giàu* ‘rich’ (25a), unless the stative predicates become eventive in the inchoative construction (25b).

- (25) a. Dững (\***tự**) ở San Diego/giàu  
 Dững (\*self) be<sub>LOC</sub> San Diego/rich  
 ‘Dững is/lives in San Diego/is rich (\*by himself).’
- b. Kim **tự** đẹp/béo ra  
 Kim self pretty/fat T-PART  
 ‘Kim became pretty/fat by herself’

I take this distribution of *tự* to suggest that *tự* expresses an instigator or causer of an event. Assuming that states by themselves do not involve instigation or causation, they are incompatible with *tự*. On the other hand, caused event such as (24) and inchoative events such as (25b) can be instigated or caused, whether the responsible force is external or internal (Levin and Rappaport Hovav 1995). Thus, *tự* is grammatical with them. If this analysis of *tự* is on the right track, one may argue that *tự* can only be adjoined to the projection introducing instigation/causation, namely, *vP* (Ramchand 2001, Folli and Harley 2005). If *tự* is adjoined to *vP*, the most likely landing site for Vietnamese main verbs is *v*.<sup>7</sup>

- (26) Kim<sub>i</sub> [<sub>vP</sub> **tự** [<sub>vP</sub> t<sub>i</sub> [<sub>v</sub> đẹp/béo<sub>j</sub> [<sub>XP</sub> ra [<sub>VP</sub> t<sub>i</sub> t<sub>j</sub> ]]]]]  
 Kim<sub>i</sub> [<sub>vP</sub> self [<sub>vP</sub> t<sub>i</sub> [<sub>v</sub> pretty/fat<sub>j</sub> [<sub>XP</sub> T-PART [<sub>VP</sub> t<sub>i</sub> t<sub>j</sub> ]]]]]

#### 4.2. Telic particles head aspect phrase

According to the proposed analysis, *telic particles* head a projection above VP and the main verbs occupy the head position of a yet higher projection, *vP*. In

other words, the projection of *telic particles* comes between *vP* and *VP*. What would such a projection be? The idea that there is a functional projection between *vP* and *VP* is not new. Based on evidence from Tagalog, Travis (1991) argued that derived objects occupy the specifier position of a functional projection between *VP* and the projection introducing causation (the higher *V* in her analysis), whose head position is occupied with the completive aspect morpheme. This functional projection is called *aspect phrase*.

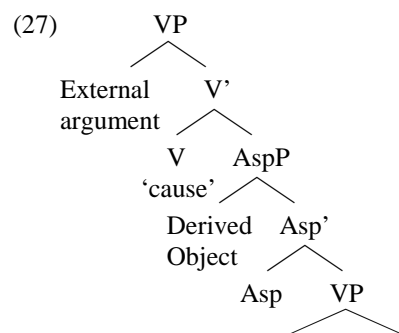

Given the syntactic position of the projection of telic particles (between *vP* and *VP*), combined with the semantic effect that they produce, I conclude that telic particles head aspect phrase.

## 5. Remaining issues

The proposed analysis of telic particles leaves one interesting fact about them unexplained: the selective nature of the word order alternation between telic particles and objects. In this last section, I suggest an analysis of the word order variation with telic particles and object NPs, which divides instances of 'telic particle-object' complexes in two types. One is a case of complex verb formation between a verb and a bare NP object, which imposes strict adjacency between them. The other is a case of object NP licensing inside and outside of *VP*, which allows for an object NP to appear in two positions.

### 5.1. Complex verb formation

As seen earlier, telic particles must follow some bare NPs and cannot intervene between these NPs and the verb. This strict adjacency requirement between some bare NPs and the subcategorizing verbs appears to be independent of telic particles, however, as adverbs also cannot intervene.

- (28) \*Chúng nó      bày      **nhanh chóng**      tranh  
 They              display      quickly              picture  
 ‘They displayed quickly picture.’ (cf. (5a))

Given the general nature of the adjacency restriction, I propose that some bare nouns form complex predicates with the subcategorizing verbs. The resulting complex predicate raises to *v*, deriving the ‘verb-object-telic particle’ order.

- (29) [<sub>VP</sub> Subj[<sub>v</sub> V+N<sub>i</sub> [<sub>AspP</sub> T-PART [<sub>VP</sub> ~~V~~+N<sub>i</sub>]]]]

Evidence supporting the complex predicate analysis comes from an apparent “(outbound) anaphoric island” effect (Postal 1969) seen with some frequent ‘verb + noun’ combinations, as in (30).

- (30) Tân      lái      xe<sub>i</sub>      và      quyết định      mua      pro<sub>??i/j</sub>  
 Tân      drive      car<sub>i</sub>      and      decide              buy      pro<sub>??i/j</sub>  
 ‘Tân drove a car<sub>i</sub> and decided to buy pro<sub>??i/j</sub>.’

In (30), the *pro* object in the second conjunct cannot have the object in the first conjunct, *xe* ‘car’, as its antecedent, suggesting that *xe* ‘car’ cannot have the referential interpretation. Such an effect is absent with less frequent combinations, such as *thử* ‘try’ and *xe* ‘car’ in (31).

- (31) Tân      thử      xe<sub>i</sub>      và      quyết định      mua      pro<sub>i/j</sub>  
 Tân      try      car<sub>i</sub>      and      decide              buy      pro<sub>i/j</sub>  
 ‘Tân tried a car and decided to buy pro<sub>i/j</sub>.’

## 5.2. Object NP licensing inside and outside of VP

In contrast with the case of strict adjacency, some other bare NPs and quantified NPs in general can precede or follow telic particles (4).<sup>8</sup> This optionality is reminiscent of the derived object positions in other languages, in which object NPs are argued to be licensed either inside or outside of VP (Mahajan 1990, Runner 1993, Diesing 1995, de Hoop 1996, Ramchand 1997). If object NPs can be licensed either inside or outside of VP in Vietnamese, the object-telic particle order obtains when an object moves out of VP (32a), while the *telic particle-object* order obtains when an object stays inside VP (32b).

- (32) a. Tân [<sub>VP</sub> tạo<sub>i</sub> [<sub>XP</sub> [nhiều vấn đề]<sub>j</sub> [<sub>AspP</sub> **ra** [<sub>VP</sub> t<sub>i</sub> t<sub>j</sub> ]]]]  
 Tân [<sub>VP</sub> create<sub>i</sub> [<sub>XP</sub> [many problem]<sub>j</sub> [<sub>AspP</sub> T-PART [<sub>VP</sub> t<sub>i</sub> t<sub>j</sub> ]]]]  
 b. Tân [<sub>VP</sub> tạo<sub>i</sub> [<sub>AspP</sub> [ra [<sub>VP</sub> t<sub>i</sub> [nhiều vấn đề] ]]]]  
 Tân [<sub>VP</sub> create<sub>i</sub> [<sub>AspP</sub> [T-PART [<sub>VP</sub> t<sub>i</sub> [many problem] ]]]]  
 ‘Tân created many problems.’

In the languages with derived object positions, different positions of objects correlate with different interpretations of them, such as specificity, definiteness, and referentiality (the references above). With Vietnamese, there appear to be differences between two positions (Duffield 1998), yet they are not always reported. Even when they are, the nature of the differences is not clear. Thus, I leave an account for the optionality of object positions for future research.

## 6. Conclusion

In this paper, I have argued that Vietnamese telic particles, which intervene between verbs and their objects and create a telic interpretation of events, head an *aspect phrase* between vP and VP. I have also proposed a preliminary analysis of the word order alternations between telic particles and objects. If the proposed analysis is on the right track, Vietnamese adds a piece of evidence for syntactic encoding of verbal aspect (Rosen 2003 and references therein). Further data and careful analyses are required, however, in order to gain insight into a potential interaction between aspect phrase and the variability of object positions.

## Notes

\* All the grammatical judgments are based on elicitations conducted between summer 2005 and fall 2006, with four native speaker informants. I would like to thank them for their time and patience. An earlier version of this paper was presented at NELS 37 at University of Illinois, Urbana Champaign. I would like to thank the audience at NELS 37, as well as the audience at WECOL 2006 at California State University Fresno, for their helpful comments and suggestions. Finally, I would also like to thank the following individuals for their generous help which improved this paper in various stages of its development: Brian Agbayani, Ivano Caponigro, Grant Goodall, James Kirby, Nayoung Kwon, John Moore, Maria Polinsky, and especially Thuan Tran. Needless to say, all the remaining errors are my responsibility.

<sup>1</sup> Abbreviations: T-PART = telic particle, CL = classifier, NEG = negation, PERF = perfective

<sup>2</sup> In Duffield (1998), what I refer to as small clause is a projection of aspect, or *aspect phrase*, although it is below the lexical verb (as opposed aspect phrase in Travis 1991, which is above VP). I refer to it as small clause in this paper, in order to avoid confusion.

<sup>3</sup> A functional projection of aspect was independently proposed also by Borer (1994). See also Rosen (2003) for an overview of the literature on syntactic analysis of aspect or event structure.

<sup>4</sup> A possible alternative analysis is that the object is post-posed in (17). However, since extraction from the post adverbial object is grammatical (i.e. *wh*-question), the post-posing analysis is unlikely.

<sup>5</sup> Agbayani and Zoerner (2006) explicitly argue that Vietnamese lacks V-to-v movement, due to lack of VP ellipsis and left-peripheral ellipsis.

<sup>6</sup> I have no account for why the negative marker cannot precede the causative construction.

<sup>7</sup> Another important question is *how* the main verbs move to v, which I leave for future research.

<sup>8</sup> There is a strong preference for quantified NPs to be sentence final in Vietnamese (Simpson 2001). Whether this has a grammatical or production/processing explanation (i.e. heaviness) is not clear.

## References

Agbayani, Brian and Zoerner, Ed. 2006. 'A parallel movement solution to puzzles of

- discontinuous ellipsis', *Folia Linguistica* **39**. 3-4: 299-318.
- Borer, Hagit. 1994. The projection of arguments. In E. Benedicto and J. Runner (eds.), *Functional Projections: University of Massachusetts Occasional Papers* **17**. pp. 19-48.
- de Hoop, Helen. 1996. *Case Configuration and Noun Phrase Interpretation*. New York: Garland.
- Diesing, Molly. 1995. 'Semantic variables and object shift', In H. Thráinsson, S. D. Epstein, and S. Peter (eds.) *Studies in Comparative Germanic Syntax* **2**. 66-84. Dordrecht: Kluwer.
- Dowty, David. 1979. *Word Meaning and Montague Grammar*. London: Reidel
- Duffield, Nigel. 1998. 'Auxiliary placement and interpretation in Vietnamese', *CLS* **34**: 95-109.
- Duffield, Nigel. 1999. 'Final modals, adverbs and antisymmetry in Vietnamese', *Revue québécoise de linguistique* **27**: 91-128.
- Folli, Raffaella. and Harley, Heidi. 2005. 'Flavors of v', In P. Kempchinsky and R. Slabakova (eds.), *Aspectual Inquiries*. 95-120. Dordrecht: Springer.
- Kratzer, Angelika. 1994. 'On external arguments', In E. Benedicto and J. Runner (eds.) *Functional Projections: University of Massachusetts Occasional Papers* **17**: 103-30.
- Kratzer, Angelika. 1996. 'Severing the external argument from the verb', In J. Rooryek and L. Zariing (eds.) *Phrase Structure and the Lexicon*. 109-137. Dordrecht: Kluwer.
- Kwon, Nayoung. 2004. 'A semantic and syntactic analysis of Vietnamese causatives', Paper presented at WECOL 2004. University of Southern California.
- Levin, Beth. and Rappaport Havov, Malka. 1995. *Unaccusativity: at the Syntax-Lexical Semantics Interface*. Cambridge, Mass: MIT Press.
- Mahajan, Anoop. 1990. *The A/A-bar Distinction and Movement Theory*. Doctoral Dissertation, MIT.
- Postal, Paul. 1969. 'Anaphoric islands', *CLS* **5**: 205-39.
- Ramchand, Gillian. 1997. *Aspect and predication: the semantics of argument structure*. Oxford: Clarendon Press.
- Ramchand, Gillian. 2001. 'First phrase syntax', Ms., University of Tromsø.
- Rosen, Sara.T. 2003. 'The syntactic representation of linguistic events', In L. Cheng and R. Sybesma (eds.), *The 2nd State of the Article Book*. 323-365. Mouton de Gruyter, Berlin (Reprinted from *Glott International* **4**, 3-10).
- Runner, Jeffery. 1993. 'Quantificational objects and Agr-o', In V.M. Lindblad and M. Gamon (eds.) *MIT Working Papers in Linguistics 20: Papers from SCIL5*: 209-24.
- Simpson, Andrew. 2001. 'Focus, presupposition and light predicate raising in East and Southeast Asia', *Journal of East Asian Linguistics* **10**: 89-128.
- Travis, Lisa. M. 1991. 'Derived objects, inner aspect, and the structure of VP', Paper presented at NELS 21. University of Delaware.

Shin Fukuda  
University of California, San Diego  
9500 Gilman Dr. La Jolla, CA 92093-1018  
fukuda@ling.ucsd.edu



# Connected Exceptives and Non-monotonic Inference

Iván García-Álvarez  
University of Salford

## 1. Introduction

Since the influential analyses of von Stechow (1993, 1994) and Moltmann (1995), among others, it is standardly assumed that connected exception phrases (EPs) such as *but Lucy* or *except Björn* are licensed only in the presence of a quantificational determiner that meets certain model-theoretic requirements: roughly, the determiner must be universal. These accounts correctly predict that sentences involving the determiner *some* or a low cardinality numeral in combination with a connected EP, such as (1) and (2), are ill-formed.

- (1) # Some girls but Lucy wear glasses.
- (2) # Three Scandinavians except Björn have won the Nobel Prize.

However, it has recently been noticed that sentences containing the determiners *most*, *many* or *few* as associates of the EP are in fact acceptable even in connected uses (García-Álvarez 2003; Peters and Westerstål 2006), as demonstrated by sentences (3) – (5) below.

- (3) Most vegetables except the tap-rooted ones can be started off in small pots and transplanted into the garden when the ground is ready. (*The Jerusalem Post*, 10/10/01)
- (4) Kate is an actress who has played many roles except that of a real woman. (*Los Angeles Times*, 14/09/96)
- (5) Few except visitors will know that Czechoslovakia produces wine. (*The Daily Telegraph*, 22/04/91)

Another problem for traditional approaches is that connected EPs can be licensed even in the absence of determiner quantification, for example, by

minimizers such as *squat*, *zilch* or *zip*, as shown by sentences (6) – (8). This fact is particularly difficult to explain under the standard view that connected EPs are constituents of complex one-place determiners (von Fintel 1993, 1994; Keenan 2003; Keenan and Stavi 1986; Keenan & Westerstahl 1997; Peters and Westerstahl 2006).

- (6) Not that signing a prenup is bad. Au contraire, it's very good and should be used to protect both parties from untoward circumstance, such as one of them getting away with all the money and property, and leaving the other with squat except kids to feed. (*The Gazette*, 30/06/2003, p. D2)
- (7) By not being New Labour or the Conservatives, they've gathered positively multitudinous voters who are quite rightly sick to death of these completely worn-out parties. But they offer them zilch except the same weary stuff. (*Herald Express*, 16/01/2006, p. 8)
- (8) In a joint telegram sent to their head offices, UNICEF and ICRC agreed. They are awaiting approval, however, from their head offices in Geneva and New York. "They have done zip except talk to Geneva," scoffed one insider. (*The Globe and Mail*, 05/04/1980)

In this paper, I offer an account of these data by suggesting that a connected EP is felicitous provided it defeats a certain (incorrect) inference about its right argument that can be plausibly drawn from its 'host,' a term that I will use here to refer to the result of excising a connected EP from the sentence in which it occurs. Thus, for example, the host of the EP *except Lucy* in (9) is sentence (10).

- (9) Every nurse except Lucy works an eight hour shift.
- (10) Every nurse works an eight hour shift.

## 2. Connected EPs and non-monotonicity

According to the influential view defended in von Fintel (1993, 1994), connected EPs preserve the truth of the statements they modify by restricting the domain of the quantificational determiners in their associates. Without such restriction, those quantificational statements would be false. Thus, if Smith is the only complainant who did not attend the hearing, the addition of the EP *but Smith* will turn the following false statement into a true one.

- (11) Every complainant attended the hearing.

This characterization, however, is not true of all acceptable uses of connected EPs, since exceptive modification does not affect the truth of non-universal statements. For example, a sentence such as (3) does not imply that the existence of tap-rooted vegetables falsifies the claim that a majority of vegetables can be started off in small pots and transplanted later. Rather, this sentence claims that most vegetables have the specified property, but that the tap-rooted ones are not part of this majority. Thus, both (12) and (13) must be true together.

- (12) Most vegetables can be started off in small pots and transplanted into the garden when the ground is ready.
- (13) The tap-rooted vegetables cannot be started off in small pots and transplanted into the garden when the ground is ready.

This realization has led some to believe that exception sentences involving less than universal determiners are somewhat marked, if not downright infelicitous, or at least that connected EPs must receive a different interpretation in these cases. I take a different view: there is, I think, nothing unusual about the examples reported in this paper and, furthermore, the meaning of connected *except*-phrases is the same both in universal and non-universal hosts.

The idea behind the account I offer in this paper, devoid of all necessary qualifications and supplementations, is that connected EPs are acceptable only in sentences that express generalizations of a certain kind. Consider the following sentence:

- (14) Most men have hair on their legs.

Sentence (14) expresses a generalization about men. This claim is rooted in the perceived existence of a majority of hair-legged men. On the basis of this claim and in the absence of information to the contrary, we are more likely to conclude that any given man has hair on his legs than to infer the opposite. However, in due recognition of the fact that professional cyclists shave their legs, a speaker may choose to qualify the sentence above with a connected EP to produce (15).

- (15) Most men except professional cyclists have hair on their legs.

Without such qualification, sentence (14) might lead us to believe something false about professional cyclists, to wit, that they have hairy legs too. Such an inference is not a logical consequence of sentence (14), but must be regarded as non-monotonic, given that it may be retracted under the presence of new information.

I argue that connected EPs may modify quantificational statements like (14) because the contextual inferences licensed by such generalization-expressing

statements typically go beyond what is strictly entailed by their truth. This observation stresses the importance of distinguishing between what can be plausibly inferred from a statement that expresses a generalization, and what makes that statement true. For instance, although sentence (14) licenses non-monotonic inferences about arbitrary members of the set of men (i.e. for all  $x \in \llbracket man \rrbracket$ , it entails non-monotonically ‘ $x$  has hair on his legs’), its truth depends simply on the existence of a majority of hair-legged men: whether or not all men in fact have the specified property is not an issue.

### 3. The meaning of connected EPs

On account of the considerations mentioned in the previous sections, I suggest the following semantics for sentences of the form ‘ $[_S \text{ } [_{NP} A \text{ except } C] [_{VP} P]]$ ’, where the symbol ‘ $|\sim$ ’ represents a non-monotonic inference relation:

$$(16) \text{ [except]} C, A, P \Leftrightarrow P(A) \wedge \ominus P(C),$$

$$\text{where } [\ominus] \begin{cases} = \lambda X_r. \neg X, \text{ if for all appropriate } P', P'(A) |\sim P'(C). \\ = \lambda X_r. X, \text{ if for all appropriate } P', P'(A) |\sim \neg P'(C). \\ = \text{undefined otherwise.} \end{cases}$$

According to this semantics, which can apply to exceptive modification of universal and non-universal statements alike, a sentence containing a connected EP expresses not one, but two propositions. The EP will be licensed provided it gives rise to a proposition which contradicts at least one of the relevant inferences that may be drawn non-monotonically on the basis of the other.

For the lexical entry in (16) I make use of a propositional exception operator ‘ $\ominus$ ’, which is interpreted as either sentential negation ( $\lambda X_r. \neg X$ ), or the identity map from any proposition to itself ( $\lambda X_r. X$ ). The meaning of a connected EP is undefined whenever neither of these other two interpretations obtains.

Under the proposed interpretation of *except*-phrases an utterance of (3), for example, will be true just in case a majority of the non tap-rooted vegetables have the predicate property and the tap-rooted vegetables do not have such property. This result corresponds with native speakers’ judgments regarding the meaning of (3), already given above as the pair of propositions (12) and (13).

The connected EP *except the tap-rooted ones* is licensed in this case because, for any predicate  $P'$  whose selectional restrictions are satisfied,  $P'$ (**the tap-rooted ones**) is a non-monotonic consequence of  $P'$ (**most vegetables**), and so the inclusion of the connected EP in order to assert  $\neg P'$ (**the tap-rooted ones**) is justified (since the tap-rooted vegetables do not have the designated property).

As I pointed out above, the acceptability of exception sentences containing the determiner *few* is not predicted by established theories of EPs. Examples of this type are also problematic for standard accounts because they undermine the following putative semantic property of exception constructions:

(17) *The Negative Condition*

Applying the predicate to the exceptions yields the opposite truth value from applying the predicate to the nonexceptions.  
(Moltmann 1995: 226, (5))

The problem with this condition is that in examples with *few* both arguments of the exceptive are claimed to have the predicate property. For example, sentence (5) above asserts that visitors know that Czechoslovakia produces wine and that, *in addition to* visitors, the number of people who have this knowledge is small. Unlike previous approaches, the proposal in (16) makes accurate predictions about these cases. Consider, for instance, the derivation of the truth-conditions of sentence (5):

$$(18) \quad (([\textit{except}]([\textit{visitors}])([\textit{few}(\textit{people})]))([\textit{know}])) \Leftrightarrow \\ |\textit{people} \cap \textit{know}| / |\textit{people}| < n \wedge \ominus(\textit{know}(\textit{visitors})) \Leftrightarrow \\ |\textit{people} \cap \textit{know}| / |\textit{people}| < n \wedge \lambda X_r.(X)(\textit{know}(\textit{visitors})) \Leftrightarrow \\ |\textit{people} \cap \textit{know}| / |\textit{people}| < n \wedge \textit{know}(\textit{visitors}).$$

The exception operator in (18) is interpreted as the identity function over propositions, since it holds that for any predicate P' whose selectional restrictions are satisfied, the proposition  $\neg P'(\textit{visitors})$  follows non-monotonically from P'(**few people**). Given that visitors do in fact know that Czechoslovakia produces wine, the availability of this inference warrants the presence of the connected EP *except visitors*.

The proposed semantics for connected EPs is compatible with the fact that such phrases can be licensed even in the absence of determiner quantification, as the acceptability of sentences (6) – (8) above suggests. The only constraint imposed by the lexical entry in (16) is that the NP associate of a connected *except*-phrase gives rise to the expression of an appropriate generalization. Clearly, there are determinerless NPs that can meet such a requirement. Consider (8) again, for example, partially repeated below as (19).

(19) They have done zip except talk to Geneva.

The presence of the connected EP *except talk to Geneva* here is legitimate because its host (i.e. 'They have done zip') may lead us to conclude erroneously that they have not talked to Geneva.

My proposal also offers a straightforward account of the infelicity of sentences like (1) and (2) above. Consider sentence (1) again, for example, repeated below as (20).

(20) # Some girls but Lucy wear glasses.

It is not difficult to see that the exception operator  $\ominus$  will be undefined in this case because both  $\exists P' \neg(P'(A) \mid\sim P'(C))$  and  $\exists P' \neg(P'(A) \mid\sim \neg P'(C))$  hold. The infelicity of example (20) stems from the fact that the host of the connected EP *but Lucy* does not express a generalization, as neither the proposition ‘Lucy wears glasses’ or its negation follow defeasibly from ‘Some girl wears glasses’ (in the absence of additional assumptions about Lucy). A similar reasoning explains the infelicity of sentence (2). In the following section, I will attempt to offer further motivation for several aspects of my proposal.

#### 4. Discussion of the proposal

The account offered in this paper entails that the interpretation of the exception operator  $\ominus$  must be ‘predicate invariant’ (i.e. it must not depend on a particular choice of P). Could the following simpler alternative to the semantics in (16), which makes no reference to predicates other than P, be adopted?

(21) **[except]** C, A, P  $\Leftrightarrow$  P(A)  $\wedge$   $\ominus$ P(C),

where  $[\ominus]$   $\left\{ \begin{array}{l} = \lambda X_r. \neg X, \text{ if } P(A) \mid\sim P(C). \\ = \lambda X_r. X, \text{ if } P(A) \mid\sim \neg P(C). \\ = \text{undefined otherwise.} \end{array} \right.$

Connected EPs are often associated with the so-called ‘Condition of Inclusion’ (Moltmann 1995), which requires that the complement of the EP is (presupposed to be) a member of the N’-restrictor of its associate. Thus sentence (22), for example, presupposes that Peter is a student.

(22) Every student except Peter arrived on time.

Unlike (16), the simpler lexical entry in (21) fails to capture this property of exception constructions. Consider the following sentence:

(23) Few professional mathematicians can prove the Poincaré conjecture.

If Smith is an amateur mathematician, the following sentence is clearly ill-formed due to a presupposition failure (given that the set of amateur and professional mathematicians are disjoint):

- (24) # Few professional mathematicians except Smith can prove the Poincaré conjecture.

The weaker semantics in (21), however, predicts no such failure of presupposition for this sentence. This is because the sentence ‘Smith cannot prove the Poincaré conjecture’ is in fact a non-monotonic consequence of ‘Few professional mathematicians can prove the Poincaré conjecture’: If the number of professional mathematicians who can prove the notoriously difficult conjecture is small, then we can defeasibly conclude that amateur mathematicians lack the necessary know-how.

The proposed semantics in (16) does not run into this problem, since it requires that other properties be considered. Whereas the relevant inference goes through when P is ‘can prove the Poincaré conjecture’, this is obviously not so for properties P’ such as ‘run a mile in less than twelve minutes’, or ‘voted Republican in the last election’.

I have also argued in this paper that, despite being syntactically sub-sentential, connected EPs always have a propositional meaning and, consequently, sentences that contain them always express more than a single proposition. Although the propositional character of exceptions is not difficult to see, it can sometimes be obscured by our everyday use of the term ‘exception’. So let me clarify with a simple case what I take to be the correct understanding of this notion.

In a situation where Kim didn’t enjoy the wine reception, but where every other linguist did, we might say that Kim is the ‘exception’ to the following generalization:

- (25) Every linguist enjoyed the wine reception.

What we mean, of course, is that the proposition that Kim didn’t enjoy the wine reception is exceptional in view of the above claim. The individual Kim is not the exception to sentence (25); the exception is the fact that Kim didn’t enjoy the wine reception.

One argument that strongly supports a propositional account of the meaning of EPs rests on the basic observation that an utterance of a sentence containing a connected EP of the form [<sub>EP</sub> *but/except*  $\alpha$ ] always commits us to the truth of some propositional claim about  $\alpha$ . Thus, a speaker of (26), for example, is not only asserting that no corporate attorney other than Smith wears cheap suits, but is crucially making a statement about Smith as well, namely that he wears cheap suits.

(26) No corporate attorney but Smith wears cheap suits.

Observe that it is not possible to deny knowledge of Smith's dressing habits explicitly and still assert sentence (26), as shown by the unacceptability of the following discourse:

(27) # I don't know about Smith, but no corporate attorney but Smith wears cheap suits.

In this regard, *but-* and *except-*phrases are in marked contrast to negative integrated relative clauses, whose semantic import is restricted only to the nouns they modify. Compare the following sentences:

- (28) a. Everybody but a New Yorker likes New York.  
b. Everybody who is not a New Yorker likes New York.

While both of these sentences make the same claim about people who are not from New York, they differ fundamentally in what they say about New Yorkers. In particular, only the first sentence makes an assertion about New Yorkers themselves, to wit, that they don't like their city of origin. This proposition, however, is merely implicated pragmatically by the second sentence, and so it can be defeated without difficulty, as shown in (29).

(29) I don't know about New Yorkers, but everybody who is not a New Yorker likes New York.

A second argument that connected EPs have propositional content comes from a range of modal adverbs that can occur between the exceptive and its complement inside the EP. Consider the following examples involving the modal adverbs *maybe*, *possibly* and *perhaps*:

- (30) Their supporting cast consists of various Shaolin fighting monks, zombies, elves and pretty much everybody you ever saw in a mall video arcade except maybe the Martians from "Space Invaders." (*The Miami Herald*, 10/03/04, p. K6390)
- (31) Adult motorists who do not use seat belts are endangering no one except possibly themselves. (*Charleston Daily Mail*, 30/03/2005, p. P4A)
- (32) "This is not good for consumer confidence and will be discouraging for everyone except perhaps the bond market," he said. (*BBC News*, 08/09/01)



Modal adverbs modify the truth of the propositions expressed by the sentences which contain them (Bellert 1977, Thomason and Stalnaker 1973). If connected EPs were constituents of complex determiners (i.e. determiner modifiers), their ability to co-occur with modal adverbs would be entirely unexpected. These distribution facts show conclusively that EPs have propositional content: modal adverbs occur with EPs precisely because these phrases have the type of content that such adverbs modify.

I have argued as well in this paper that connected EPs do not operate directly on the domain of quantificational determiners, but that a sentence such as (33) simply expresses the conjunction of propositions in (34).

(33) Every student except Oliver smokes.

(34)  $(([\textit{except}][[\textit{Oliver}]])([\textit{every student}])([\textit{smokes}])) \Leftrightarrow$   
 $(\textit{student} \subseteq \textit{smokes}) \wedge \ominus(\textit{smokes}(o)) \Leftrightarrow$   
 $(\textit{student} \subseteq \textit{smokes}) \wedge \lambda X_r.(\neg X)(\textit{smokes}(o)) \Leftrightarrow$   
 $(\textit{student} \subseteq \textit{smokes}) \wedge \neg \textit{smokes}(o).$

The connected EP *except Oliver* is licensed (and the exception operator  $\ominus$  is interpreted as external negation) in this case because, for any predicate P' whose selectional restrictions are satisfied, P'(o) is a non-monotonic consequence of P'(every student). However, given my assumption that a speaker of (33) also presupposes the proposition that Oliver is a student, the formula  $(\textit{student} \subseteq \textit{smokes}) \wedge \neg \textit{smokes}(o)$  in (34) does not have a model, i.e. it expresses a necessary falsehood. Obviously, the truth of an *utterance* of (33) requires that the domain of *every* be restricted (pragmatically) to all those students who are not Oliver, as in (35) below.

(35)  $(\textit{student} - [\textit{Oliver}] \subseteq \textit{smokes}) \wedge \neg \textit{smokes}(o).$

But domain restriction is not part of the semantic (i.e. compositional) contribution of connected *except*-phrases, just as restricting the domain of the quantifier *nobody* to those values of *x* such that  $x \neq \textit{Kim}$  in (36) is not a component of the meaning of *only*, but simply an instance of a more general pragmatic phenomenon.

(36) Nobody knows our secret, only Kim.

Notice also that, as shown in the paper, connected EPs can readily occur in the absence of explicit determiner quantification, which seems to rule out assuming quantifier domain restriction as part of the semantics. Furthermore, a pragmatic process of domain restriction needs to be independently posited even in senten-

ces where quantificational determiners are present, and so we might argue on the grounds of theoretical parsimony that only pragmatic restriction is needed.

## 5. Conclusion

In this paper I have offered an account of connected EPs which highlights their role in blocking incorrect inferences that may be derived non-monotonically on the basis of their hosts. This proposal was shown to have at least two positive consequences. First, the approach is not tied to the occurrence of universal determiners in the hosts of connected EPs. This stance is supported by the well-formedness of examples with non-universal determiners, as well as by the acceptability of exception sentences that contain no determiners at all. Second, the predictions of my proposal bode well with the body of evidence which suggests that, although syntactically subsentential, connected EPs are always propositional in their semantics. It also suggests that exception markers have a meaning related to that of adversative coordinators, and thus acknowledges the well-known observation that these markers often have independent adversative uses cross-linguistically (Hoeksema 1996).

## Notes

I would like to thank the audience at WECOL 2006 for their questions and comments, and the European Studies Research Institute (University of Salford) for financial support. Due to space limitations crucial aspects of the semantics of connected EPs have been dealt with only cursorily in this paper. I refer readers to García-Álvarez (In progress) for a more detailed analysis of the semantics of EPs.

## References

- Bellert, Irena. 1977. 'On Semantic and Distributional Properties of Sentential Adverbs,' *Linguistic Inquiry*, **8**: 2: 337-350.
- von Stechow, Kai. 1993. 'Exceptive Constructions,' *Natural Language Semantics*, **1**: 2: 123-148.
- von Stechow, Kai. 1994. *Restrictions on Quantifier Domains*. Ph.D. Dissertation, UMass, Amherst.
- García-Álvarez, Iván. 2003. 'Quantifiers in Exception NPs,' in G. Garding and M. Tsujimura (eds.), *WCCFL 22 Proceedings*. Somerville, MA: Cascadilla Press, pp. 207-216.
- García-Álvarez, Iván. In progress. *A general Theory of Exception Phrases*. Ph.D. Dissertation, Stanford University.
- Hoeksema, Jacob. 1990. 'Exploring Exception Phrases,' in Martin Stokhof and Leen Torenvliet (eds.), *Proceedings of the Seventh Amsterdam Colloquium*. Amsterdam:

- ITLI, pp. 165-189.
- Hoeksema, Jacob. 1996. 'The Semantics of Exception Phrases,' in Jaap van der Does and Jan van Eijck (eds.), *Quantifiers, Logic and Language*. Stanford, CA: CSLI Publications, 145-177.
- Keenan, Edward. 2003. 'The Definiteness Effect: Semantics or Pragmatics?,' *Natural Language Semantics*, **11**: 187-216.
- Keenan, Edward and Jonathan Stavi. 1986. 'A Semantic Characterization of Natural Language Determiners,' *Linguistics and Philosophy*, **9**: 253-326.
- Keenan, Edward and Dag Westerståhl. 1997. 'Generalized Quantifiers in Linguistics and Logic,' in Johan van Benthem and Alice ter Meulen (eds.), *Handbook of Logic and Language*. Amsterdam: Elsevier and Cambridge: MIT Press, 837-893.
- Lappin, Shalom. 1996. 'Generalized Quantifiers, Exception Phrases, and Logicality,' *Journal of Semantics*, **13**: 197-220.
- Moltmann, Friederike. 1992. *Coordination and Comparatives*. Doctoral Dissertation, MIT.
- Moltmann, Friederike. 1995. 'Exception Sentences and Polyadic Quantification,' *Linguistics and Philosophy*, **18**: 223-280.
- Peters, Stanley and Dag Westerståhl. 2006. *Quantifiers in Language and Logic*. Oxford: Oxford University Press.
- Thomason, Richmond and Robert Stalnaker. 1973. 'A Semantic Theory of Adverbs,' *Linguistic Inquiry*, **4**: 195-220.

*Iván García-Álvarez*  
*University of Salford*  
*Salford, Greater Manchester,*  
*M5 4WT, United Kingdom*  
*i.garciaalvarez@salford.ac.uk*

# Extrapolation as PF Movement

Edward Göbbel

University of Tübingen

## 1 Introduction

This paper discusses extrapolation (EX) from subject and object in English, illustrated in (1). It explores the possibility that EX, or at least a subset of EX constructions, are operations in the Phonological Component (PF), as has been repeatedly suggested by Chomsky (Chomsky 1995, 2005).

- (1) a. A new book appeared last year *about Turner*.  
 b. He sold a painting at Sotheby's *by Turner*.

The starting point of my investigation is a distinction made by Chomsky (2001) between syntactic movement to the edge of a phase and PF movement. The former subsumes classical A'-movement, object shift and movement of discourse-related categories like topic and focus (cf. also Chomsky 2002: 113ff.). The latter includes some of the classical 'stylistic' rules, e.g., a Th/Ex rule in English, displacing objects either to the left or to the right in presentational-*there* constructions.

If stylistic rules like EX and Th/Ex are not syntactic, then the triggers must be sought in phonological properties of the language. Phonological constraints can also have an effect on overt syntactic operations, so it is necessary to distinguish the following two types of movement at the syntax-phonology interface:

- Movement occurs in the syntax. It is feature-driven, but conforms to phonological properties of the language in question. The operation may have semantic effects (e.g., it can give rise to new binding configurations). The operation targets a specifier of a functional projection, which is linearised to the left of the head at PF.
- Movement occurs at PF. The dislocation has no syntactic or semantic motivation. Semantically, it corresponds to 'reconstruction' of the moved constituent to its base position or some position it may have moved to in the syntax. Constraints on the operation are purely phonological. Since movement is

not associated with (checking or valuation of) syntactic features, the target is not necessarily a specifier and therefore rightward dislocation cannot be excluded.

Examples of syntactic movement are movement of contrastive topics in German in order to avoid a *stress clash* (Féry in print) and leftward movement of defocused objects in Romanian in order to avoid right-peripheral sentential prominence (Göbbel 2003). An example of PF movement is clitic right-dislocation in Catalan, triggered by phonological interface constraints (López 2006).

The main claim of this paper is that EX in English is a consequence of options in the prosodic phrasing of utterances. In section 2, I discuss properties of EX which would qualify it as a candidate for PF movement. Section 3 presents an optimality-theoretic account of optional EX and section 4 is the conclusion.

## 2 Properties of Extraposition

### 2.1 Lack of syntactic trigger

Early approaches to EX (Baltin 1978, Chomsky 1981) were essentially movement analyses. Movement could be postulated freely (Move  $\alpha$ ) and constraints on this operation were stated in terms of subjacency and other conditions that are no longer available. In current minimalist theory the displacement property is handled in terms of features like [wh], [focus] and [topic] associated with the EPP property.

EX is often considered an English focus construction (cf. Huck & Na 1990). Example (2) shows that EX can isolate a narrow focus and one could in principle invoke a F(ocus)-movement analysis.<sup>1</sup> An analysis from a current perspective would be extraction of the focused constituent to the edge of the v\*P-phase, followed by remnant movement of the defocused vP, as in (3).

- (2) a. What kind of a review did he leave on the table?  
 b. He left a review on the table [<sub>F</sub> of TURNER].
- (3) a. [<sub>vP</sub> left a review [<sub>F</sub> of TURNER] on the table] → F-movement  
 b. [[<sub>F</sub> of TURNER]<sub>i</sub> [<sub>vP</sub> left a review t<sub>i</sub> on the table]] → vP-movement  
 c. [[<sub>vP</sub> left a review t<sub>i</sub> on the table]<sub>j</sub> [[<sub>F</sub> of TURNER]<sub>i</sub> [<sub>vP</sub> t<sub>j</sub> ]]]

However, syntactic triggers cannot be defined for all cases of EX. Problematic are examples in which EX results in a sentence with a discontinuous focus. An example is (4) and the two F(ocus)-marked constituents have equal phonological prominence.<sup>2</sup> A F-movement analysis is questionable here because there is also the possibility of shifting the whole focused object (i.e. HNPS), as in (5).

- (4) What did he leave on the table?  
 a. He left [<sub>F</sub> a review] on the table [<sub>F</sub> of Turner].  
 b. (He left <sup>L+H\*</sup>review on the table <sub>L-</sub>) (of <sup>L+H\*</sup>Turner <sub>L-</sub>)
- (5) a. What did he leave on the table?  
 b. He left on the table [<sub>F</sub> a review of Turner].

Another problem for syntactic movement is the fact that EX is always possible in broad focus contexts. Regardless of whether it occurs from object (6) or subject (7), it is often optional. EX from subject is in fact frequent in news reports.

- (6) What do you want to tell me?  
 a. (You'll find a review of Túrner) (in your in-tray)  
 b. (You'll find a review in your in-tray) (of Túrner)
- (7) a. (Pictures of every térrorist) (will be distributed)  
 b. (Pictures will be distributed) (of évery térrorist)

EX of DEFOCUSED material from subject and object is also frequent, and optional. Movement of the PP in (8) cannot be due to some topic feature because it contains a weak pronoun. Weak pronouns are not normally marked as topics in topic-prominent languages. Extraposed relative clauses like (9) are not topics either because they are not referential expressions. Consequently, from the point of view of focus structure and its encoding in the syntax, a range of EX constructions cannot be handled in terms of movement to the edge of a phase.

- (8) There is apparently a new product from India that would be allowed.  
 a. (But nó information *on it* was given)  
 b. (But nó information was given *on it*)
- (9) a. Aren't you going to invite Rupert and Martin?  
 b. Don't you know they fight all the time. (I don't WANT people in my house *who are so quarrelsome*)

## 2.2 Further problems for a syntactic analysis

If EX is not a syntactic movement operation, then it should not be sensitive to syntactic islands, such as the subject island constraint. From pairs like (10), which show that EX is more liberal than leftward movement, Culicover & Rochemont (1990) and Haider (1994) conclude that EX cannot involve syntactic movement and the PP must be base-generated in its right-peripheral position.

- (10) a. [A man \_ ] came into the room *with blond hair*.  
 b. \*With what color hair did [a man \_ ] come into the room?

Generating the PP separately from its source runs into trouble with the standard compositional interpretation of sentence structure. A movement approach should be preferred if it CAN be motivated. But there are better examples: PP complements, as opposed to PP adjuncts, can be extracted both leftward and rightward if the subject is an internal argument, as in (11). Only external arguments are true syntactic islands for leftward movement (cf. Chomsky 2005), and EX seems to be sensitive to them, as in (12).

- (11) a. About what did [a great disturbance \_] arise about that time?  
 b. [A great disturbance \_] arose *about a Coptic secretary*.  
 (12) a. \* [An agent \_] shouted at me *from the FBI*.  
 b. \* [A man \_] shot a lawyer (yesterday) *from the Cosa Nostra*.

However, the constraint at work is phonological, not syntactic (cf. Truckenbrodt 1995). If the input to EX is a subject-prominent sentence, then rightward dislocation is possible from an external argument, as can be seen in (13). Rochemont & Culicover (1990: 65) show that contextual deaccentuation of the predicate has the same effect in (14). An account for (12) will be provided in section 3.2.

- (13) a. An *á*gent from the FBI talked to me.  
 b. An agent talked to me *from the FBI*.  
 (14) Suddenly there was the sound of lions growling. Several women screamed. Then a man screamed *who was standing at the very edge of the crowd*.

A syntactic movement approach also fails tests for strict c-command, particularly tests involving licensing of NPIs and variable pronoun binding. If the PP in (15) moves in overt syntax, then the negative Q does not c-command the NPI, neither on a rightward movement analysis with adjunction to vP, nor on a leftward movement analysis with subsequent vP remnant movement. If the relative clause in (16), discussed by Haider (1994), is displaced in the syntax, then the pronoun contained in the relative clause will not be c-commanded by the indirect object. NPIs cannot be licensed under reconstruction and semantic binding of variable pronouns requires syntactic binding (cf. Heim & Kratzer 1998). These examples, however, are compatible with an analysis in which the NP and the extraposed constituent form one constituent in the syntax and displacement occurs after Spell-Out.<sup>3</sup>

- (15) The CEO [<sub>vP</sub> gave [<sub>QP</sub> *no* indication \_] yesterday] about *any* impact on production.  
 (16) I would not [<sub>vP</sub> tell everyone<sub>i</sub> [all the details \_] at once] that he<sub>i</sub> might be interested in.

Another aspect which raises doubts about a syntactic movement analysis is the lack of freezing effects. Constituents displaced in the syntax are normally 'frozen' for further extraction, but Huck & Na (1990: 60) have shown that, contrary to general belief, extraposed constituents can be extracted from. The grammaticality of their examples (17) can be explained if the prepositions have been dislocated AFTER wh-movement has applied. In a phase-based model of syntax, wh-movement is the last syntactic movement applying in a sentence.

- (17) a. Okay, you saw a picture yesterday, but by just whom did you see a picture yesterday OF?  
 b. Here's an article in *the Tribune* by Trevor, of all people; he's someone I'd expect to read a story in the paper ABOUT.

### 2.3 Sensitivity to phonological constraints

If EX is a PF operation, then it should be sensitive to phonological constraints. Both extraposition from subject (SX) and object (OX) obey essentially similar restrictions. SX typically occurs inthetic sentences, in which the predicate is deaccented. SX is also possible if the predicate is accented and mapped to the same MaP as the subject. Cf.:

- (18) a. (In nineteen eleven) (a stéamer sank) (from the Cúnard Line)  
 b. (A mán walked into the bár on Monday) (who we knéw at schóol)

SX can be blocked by an adverb, as in (19). Defocussing the predicate together with the adverb, as in (20), allows the PP to shift.

- (19) ??In 1911, a steamer sank quickly from the Cunard Line.  
 (20) The Cunard Liner *Lusitania* was torpedoed by a U-boat and sank quickly. (I'm álso pretty sure) (a stéamer sank quickly) (from the White Stár Line). I think it was the *Arabic*.

In OX, the moved constituent can cross a series of VP adverbials, particularly, locative, temporal and object-oriented adverbials. But it cannot cross certain VP adverbs, like manner and rate adverbs. Cf.:

- (21) a. (I read a mágazine on the tráin) (about Túrner)  
 b. (I read a mágazine on Mónday) (about Túrner)  
 (22) a. ?I read a magazine carefully about Turner.  
 b. ?I read a book slowly of more than 500 pages.  
 c. ?I hired a man immediately from Tübingen.



The only account I am aware of which attributes ungrammatical EX to phonological constraints is Truckenbrodt (1995). The essence of his proposal is that EX is not possible across a separate phonological phrase ( $\Phi$ ). A  $\Phi$  is the domain of phrasal stress and may be smaller than a MaP. This constraint correctly rules out examples like (12) and (22), but predicts EX across the PP adverbials in (21) to be ungrammatical as well.

Now, what is special about postverbal adverbs such that they can block EX? The adverbs in (22) all have the option to occur in preverbal or postverbal position. They occur in preverbal position if they are integrated into a broader focus or if the adverb is defocused (cf. Göbbel in print). Postverbal position of manner adverbs is typically the position in which they are focused or asserted. This can be demonstrated with the temporal *since*-clauses in (23), which introduce presuppositions and disallow asserted information (cf. Shaer 2003). Postverbal adverbs are also phonologically prominent and tend to be associated with a rising pitch accent (L+H\*). By default they also associate with focus-sensitive particles like negation.

- (23) a. Since John *quietly* entered the room, he's been looking for a seat.  
 b. #Since John entered the room *quietly*, he's been looking for a seat.

In Selkirk (2005), phonologically prominent constituents like narrow focus, contrastive and non-contrastive topics (all termed FOCUS) are argued to bear IP-level prominence, while information focus is only associated with MaP-level prominence. In other words, neutral renditions of sentences do not contain any constituent bearing IP-level prominence at all, only the designated terminal element of a FOCUS bears IP-level prominence and entails the presence of an IP and an IP-boundary in its immediate vicinity.

If the relatively prominent postverbal adverbs in (19) and (22) are associated with IP-level prominence, then the degraded acceptability of these examples can be attributed to the fact that EX is confined within the boundaries of an IP. This is confirmed by that fact that IP-boundary cues such as pause or significant disjuncture as well as H% boundary tones preceding the extraposed constituent are rarely found. Consequently, evaluation of EX constructions occurs at the level of the MaP and further constraints must be defined at this level.

#### 2.4 What triggers extraposition?

The trigger for EX is probably some condition governing the organisation of more complex syntactic structures. Wasow (2002: 6f.) suggests that EX is subject to a 'Principle of End Weight' (PEW), which requires phrases to be presented in order of increasing weight. The rather slippery notion of weight has recently been formulated as a constraint on prosodic structure by Selkirk (2001), as in (24). The basic idea is that a moved constituent must be at least as heavy as

the preceding phonological constituent, where weight is measured in terms of accentual/minor phonological phrases (MiPs).

- (24) **Weight Increase** (Selkirk 2001).  
In a sequence  $\alpha\beta$  of prosodic constituents,  $W(\beta) \geq W(\alpha)$ .

Weight increase was designed to deal with HNPS, shown in (25). EX, however, does not conform to this constraint in neutral contexts. Although increasing weight enhances the probability of EX, it is not a necessary condition. In (26), the extraposed phrase is lighter than the preceding MaP.

- (25) a. ??(He sóld at Sótheby's) (a páinting)  
b. (He sóld at Sótheby's) (a páinting by Túrner)  
(26) (He sold a páinting at Sótheby's) (by Túrner)

An answer for the trigger can be sought in examples in which extraposition is virtually obligatory. In the verb particle construction (27), the object containing a relative clause cannot precede the Prt. The relative clause has to be extraposed or the whole object must shift. It seems that it is THE COMPLEXITY OF THE DP ITSELF and the effect it has on prosodic phrasing that is to blame for the shift. DPs that contain a clausal constituent count as 'heavier' than DPs which don't.<sup>4</sup> Relative clauses in English are aligned with a MaP boundary at their right edge (Fodor 2002, Selkirk 2005), and such a boundary is not tolerated here.

- (27) a. ??He called *people who he didn't know* up.  
b. He called *people* up *who he didn't know*.

Apart from the effect of complex DPs on the prosodic phrasing of utterances, which will be explored in section 3, EX applies fairly freely. Particularly EX of defocused constituents illustrates this freedom, as in (28) below and (8)/(9) above. I propose the operation in (29). Adjunction at PF is attachment of constituents to phrasal projections that are aligned with the edge of a MaP. Since alignment of MaP boundaries is always with right edges of syntactic constituents in English, movement at PF is only rightward. Defocused constituents cannot be mapped to separate MaPs and will be incorporated into an existing one.

- (28) They give *nó information (about them)* at the moment (*about them*)  
(29) **PF Adjunction**  
Adjoin XP to a phrasal projection which is aligned with a MaP.

### 3 Towards an Account of Optional Extraposition

In this section I argue that that optional EX in neutral contexts is a consequence of options in the prosodic phrasing at the level of the MaP. The analysis is couched in the framework of Optimality Theory, integrated on the PF side of a Minimalist Grammar (Selkirk 2001, Kratzer & Selkirk 2007). The syntax generates the grammatical constructions in the traditional way and the interpretive components are only fed core syntactic structures, including those resulting from movement in the syntax. The PF component allows additional word order options due to the availability of PF adjunction. On the PF branch, a set of candidates are generated from the syntactic output, consisting of syntactic and prosodic structures, including EX structures. The candidates are evaluated in parallel and the optionality of EX is due to independent constraints on prosodic phrasing. Before turning to EX, I will outline an account of prosodic phrasing.

#### 3.1 Prosodic phrasing and derivation by phase

Selkirk (2000) accounts for the optional phrasing patterns in an English verb phrase like (30) in terms of same-ranked constraints, namely ALIGN XP and Truckenbrodt's WRAP XP. These are defined in (31) and (32).

- (30) a. (She loaned her rollerblades to Robin)  
 b. (She loaned her rollerblades) (to Robin)  
 c. \* (She loaned) (her rollerblades to Robin)
- (31) ALIGN (XP, R; MaP, R)  
 The right edge of any XP in syntactic structure must be aligned with the right edge of a MaP in prosodic structure.
- (32) WRAP XP  
 Each XP is contained in a MaP.

The constraint interaction can be seen in the tableaux in Figure 1. Candidate (a) violates ALIGN XP because the NP *rollerblades* is not aligned with the right edge of a MaP. Candidate (b) violates WRAP XP because the VP is not contained in one single MaP. Finally, candidate (c) violates both constraints and is ruled out.



| She loaned her rollerblades to Robin                                                                                            | Align XP | Wrap XP |
|---------------------------------------------------------------------------------------------------------------------------------|----------|---------|
|  (She loaned her rollerblades to Robin) a.   | *        |         |
|  (She loaned her rollerblades) (to Robin) b. |          | *       |
| (She loaned) (her rollerblades to Robin) c.                                                                                     | *        | *       |

Figure 1

This account, however, does not predict the prosodic structure of VPs containing clausal complements. As noted by Taglicht (1998), CPs can be phrased separately. WRAP XP predicts the CPs in (33) to be wrapped with the verb into one MaP and ALIGN XP cannot account for the MaP boundary after the verb either.

- (33) a. (She mentioned) (that her jeans were dirty)  
 b. (We prefer) (for Mary to read to the children)

Let us assume, following a proposal by Selkirk & Kratzer (2005), that a strong phase in syntactic structure corresponds to a MaP in phonological structure. In other words, the cyclic Spell-Out operation already specifies the prosodic structure of the sentence. Cyclic Spell-Out of a simple transitive sentence like (34) derives two MaPs, one corresponding to the v\*P-phase and one containing the constituents spelled out at the level of the CP-phase. Unaccusative/passive sentences are one phase in the syntax and will be mapped to single MaPs (35), regardless of whether they have an accented predicate. This procedure also correctly derives the phrasing of the examples in (33).<sup>5</sup>

- (34) a. (Mary's mother) (reads to the children)  
 b. [<sub>CP</sub> Mary's mother [<sub>VP</sub> reads to the children]]  
 (35) a. (The kéys have disappeared)  
 b. (A mán walked into the bár on Monday)

In order to preserve Selkirk's account of optional phrasing in triadic constructions, the role of WRAP XP will be taken over by an Output-Output faithfulness constraint, which tries to preserve the phrasing derived by cyclic Spell-Out. MAX<sub>OO</sub> in (36) requires faithfulness to the output of cyclic Spell-Out; it requires the MaPs derived by the syntax be inherited in phonological structure.

- (36) MAX<sub>OO</sub>  
 Every MaP derived by cyclic Spell-Out corresponds to a MaP in phonological structure.

Phases are transferred to PF in the order in which they are completed. There are several syntactic configurations in which arguments or adjuncts cannot be spelled out together with the verb in one MaP. In (37), the complement clauses are mapped to separate MaPs upon transfer to PF and the PPs must be integrated into the prosodic structure at a later stage. They will be mapped to separate MaPs if they can be accented (38a), or they will be incorporated into an existing MaP by way of a recursive MaP (38b), which I assume violates MAX<sub>OO</sub>.<sup>6</sup> The grammar can readjust the syntactic structure at PF: by shifting the CPs, as in (39), it creates a syntactic configuration in which the PPs are contained in the

same MaP as the verb. We now have the tools to deal with EX, of which (39b) is an example.

- (37) a. (She mentioned) (that her jeans were dirty) to Bill  
 b. (I've no idea) (when it will rain) at the moment
- (38) a. (She méntioned) (that her jéans were dirty) (to Bill)  
 b. (I've nó idéa) ((when it will ráin) at the moment)
- (39) a. (She méntioned to Bill) (that her jéans were dirty)  
 b. (I've nó idéa at the moment) (when it will ráin)

### 3.2 Extraposition as PF adjustment

EX is a process which adjusts the syntactic structure to the requirements of the interface constraints. Due to the complexity of the object in (40), the output of the syntax is such a big MaP that it has to be broken up or something has to be removed from it. The syntactic structure is shown in Figure 2.<sup>7</sup> This structure and the phrasing derived by Spell-Out will be the input to GEN, which generates candidates like those in (41). Candidate (41c) is the result of PF-movement, which adjoins the PP to VoiceP.<sup>8</sup>

- (40) Output of Spell-Out:  
 (You'll find a review of Turner in your in-tray)
- (41) Output of GEN:  
 a. (You'll find a review of Turner in your in-tray)  
 b. (You'll find a review of Turner) (in your in-tray)  
 c. (You'll find a review in your in-tray) (of Turner)

The candidates are evaluated in parallel, which is shown in the tableaux in Figure 3. The interface constraints apply to the maximal projection to which a head moves (cf. Truckenbrodt 1999), namely, nP and VoiceP. I also assume that  $MAX_{OO}$  is satisfied as long as the lowest segment of VoiceP is contained in one MaP. Candidate (a) has two nPs (to which *review* and *Turner* move) requiring alignment with the right edge of a MaP, hence violates ALIGN XP twice. Insertion of a MaP boundary after *Turner* in candidate (b) satisfies ALIGN XP for both nPs, at the cost of violating  $MAX_{OO}$ . Finally, EX of the PP (candidate c) results in one violation of ALIGN XP, while satisfying  $MAX_{OO}$ . Since the two constraints are same-ranked, both (b) and (c) are optimal.

An example of SX with an accented predicate is (42). Here the whole sentence is one phase in the syntax. As in the previous example, candidate (43a) violates ALIGN XP twice and is ruled out. Candidates (43b) and (43c) incur only one violation of  $MAX_{OO}$  and ALIGN XP, respectively.

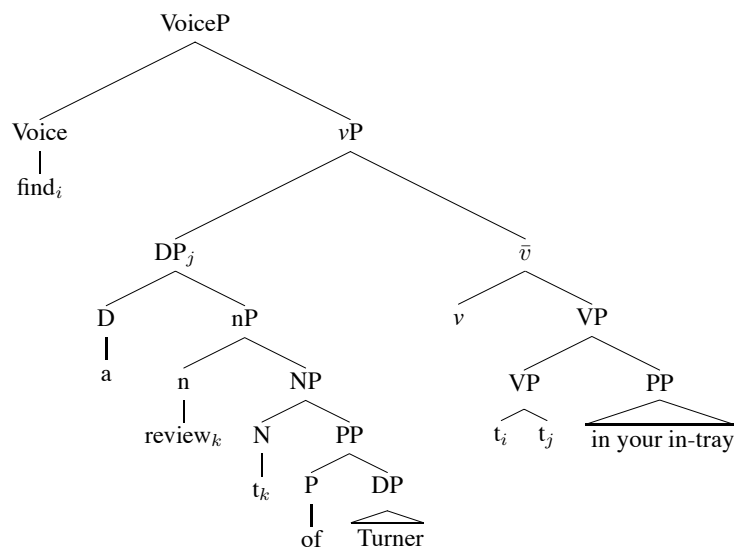

Figure 2

| (You'll find a review of Turner in your in-tray)                                              | Align XP | Max <sub>OO</sub> |
|-----------------------------------------------------------------------------------------------|----------|-------------------|
| (You'll find a review of Turner in your in-tray] <sub>VoiceP</sub> ) a.                       | **       |                   |
| (You'll find a review of Turner] <sub>nP</sub> ) (in your in-tray] <sub>VoiceP</sub> ) b.     |          | *                 |
| (You'll find a review in your in-tray] <sub>VoiceP</sub> ) (of Turner] <sub>VoiceP</sub> ) c. | *        |                   |

Figure 3

- (42) Output of Spell-Out:  
(Pictures of every terrorist will be distributed)
- (43) Output of GEN:  
a. (Pictures of every terrorist will be distributed)  
b. (Pictures of every térrorist) (will be distributed)  
c. (Pictures will be distributed) (of évery térrorist)

The analysis presented here allows for a straightforward explanation of why EX is not possible from subjects of unergative and transitive verbs, as in (12) above. The verb phrase and the subject are mapped to separate MaPs on the v\*P and CP cycle, respectively. MAX<sub>OO</sub> is satisfied, and so is Align XP, no matter how complex the subjects actually are. There is nothing to adjust. EX is not necessary and therefore not possible.

An apparent problem for my account of optional EX are cases in which the constituent moves across material that may be deaccented, as in standard thetic sentences like (44) and also (39b) above. The source structure exhibits a

recursive MaP, which is practically enforced by the two nPs that have to be aligned with the right edge of a MaP. Recursive phonological structures, however, are prohibited by NONRECURSIVITY (Selkirk 1995). The solution is probably to be sought in a further optionality, namely, the possibility to accent the predicate in the source sentence and map it to a separate MaP, as in (45). Essentially following Gussenhoven (2005), I assume two further constraints: \*MAP, R in (46) and \*MAP, L in (47) prohibit right and left edges of MaPs and conjointly embody a more general constraint banning MaPs altogether (cf. Truckenbrodt 1999). If \*MAP, L is same-ranked with NONREC and MAX<sub>OO</sub> is also violated because a recursive structure does not correspond to the output of Spell-Out, then the constraint ranking in Figure 4 gives the correct result.<sup>9</sup>

- (44) a. ((A *néw* book about *Túrner*<sub>L</sub>) appeared last year<sub>L%</sub>)  
 b. (A *néw* book appeared last *yéar*) (about *Túrner*<sub>L</sub>)  
 (45) (A *néw* book about *Túrner*<sub>L</sub>) (appéared last year<sub>L</sub>)  
 (46) \*MAP, R: Do not have a right edge of MaP.  
 (47) \*MAP, L: Do not have a left edge of MaP.



| (A new book about Turner appeared last year)                                                                                       | Align XP | Max <sub>OO</sub> | *MaP, R | *MaP, L | NonRec |
|------------------------------------------------------------------------------------------------------------------------------------|----------|-------------------|---------|---------|--------|
| (A new book about Turner appeared last year)                                                                                       | **       |                   | *       | *       |        |
|  ((A new book about Turner) appeared last year) |          | *                 | **      | *       | *      |
|  (A new book about Turner) (appeared last year) |          | *                 | **      | **      |        |
|  (A new book appeared last year) (about Turner) | *        |                   | **      | **      |        |

Figure 4

## 4 Conclusion

This paper has explored a new way to deal with classical 'stylistic' rules like extraposition. The main proposal is that extraposition from NP occurs when a NP is syntactically complex. The complexity of the NP has a direct effect on the prosodic phrasing of the utterance and phonological interface constraints are responsible for the optional adjustment of syntactic structure at PF. If the analysis presented here is on the right track, then it opens up new perspectives on other rightward movement constructions as well.

## Notes

<sup>1</sup> F-movement in the syntax has strong crosslinguistic support and is often analysed as movement to a structural focus position at the edge of the CP-phase or the edge of the v\*P-phase. Cf. Drubig (in print) for a recent overview and insightful discussion.

<sup>2</sup> Round brackets indicate major phonological phrases (MaP), aka intermediate phrases, whose boundaries are marked by phrase accents (L- and H-). Pitch accents are starred L\*, H\*, L+H\* and

intonational phrases (IP) are marked by boundary tones (L% or H%). Accents (´) are used to indicate accented syllables, when tones are not relevant.

<sup>3</sup> These examples are not problematic for Haider (1994), who assumes only rightward branching structures and the extraposed constituent is the most deeply embedded one in a recursive VP-shell structure. It is however unclear how the discontinuous constituents should be interpreted.

<sup>4</sup> Cf. Wasow (2002) and references cited there. The pair in (i) clearly shows the effect of clausal embedding.

- (i) a. \*I called *the man who left* up.  
b. He called *all of my best friends* up. (Fraser 1974: 19)

<sup>5</sup> Note that a lexical verb is spelled out on the v\*P phase since it raises to v\* only at PF (cf. Chomsky 2001: 37f.). The idea that the phonological structure is a direct consequence of Spell-Out is explicitly argued for in Kratzer & Selkirk (2007), an article which came to my attention only on the eve of completion of this paper. They also argue that 'stray' material is incorporated in terms of recursive MaPs, an idea I am also pursuing below. There are however considerable differences in the concrete implementation, particularly the fact that a MaP may correspond to the object only and verbs are incorporated at a later stage. A full comparison cannot be undertaken due to space limitations.

<sup>6</sup> Cf. Ladd (1992), Selkirk (1995) and Truckenbrodt (1999) on recursive phonological constituents.

<sup>7</sup> The structure of the verb phrase is fairly standard: the verb raises to Voice at PF, which introduces the subject (not represented here). VP adverbials are adjoined to VP and the object undergoes short object movement (Bowers 2002) to Spec-vP. This gives the correct result for traditional c-command tests (cf.: *We have found no review in any British journal*). In the DP, the noun N raises to *n* at PF.

<sup>8</sup> I ignore the CP phase, which has no effect on phrasing in this example. It contains only clitical material, which is incorporated at the level of the prosodic word (cf. Selkirk 1995).

<sup>9</sup> Note that \*MaP, L and \*MaP, R can only be violated once at any edge, whereas the gradability of ALIGN XP (cf. Fodor 2002) is crucial for capturing the 'complexity' of an NP and its effect on prosodic phrasing. The analysis of the examples relies on the phonetic evidence: the fall (L-) in the source sentences is always within the complex NP. After EX the fall may occur at some 'distance' from the NP and additional pitch accents on initially deaccented material are not disallowed.

## References

- Baltin, Mark. 1978. "PP as a Bounding Node", *NELS* 8: 33-40.  
 Bowers, John. 2002. "Transitivity", *Linguistic Inquiry* 33, 183-224.  
 Chomsky, Noam. 1981. *Lectures on Government and Binding*. Dordrecht: Foris.  
 Chomsky, Noam. 1995. *The Minimalist Program*. Cambridge, Mass.: MIT Press.  
 Chomsky, Noam. 2001. "Derivation by Phase". In M. Kenstowicz (ed.), *Ken Hale: A Life in Language*, 1-52. Cambridge, Mass.: MIT Press.  
 Chomsky, Noam. 2002. *On Nature and Language*. Cambridge: CUP.  
 Chomsky, Noam. 2005. On Phases. Ms., MIT.  
 Culicover, Peter & Rochemont, Michael. 1990. "Extraposition and the Complement Principle", *Linguistic Inquiry* 21, 23-47.  
 Drubig, Bernhard. in print. "Towards a Phase-based Theory of Information Structure". In K. Schwabe & S. Winkler (eds.), *On Information Structure, Meaning and Form*. Amsterdam: Benjamins.  
 Féry, Caroline. in print. "The Prosody of Topicalization". In K. Schwabe & S. Winkler (eds.), *On Information Structure, Meaning and Form*. Amsterdam: Benjamins.  
 Fodor, Janet. 2002. "Psycholinguistics cannot Escape Prosody". In B. Bel & I. Marlien (eds.), *Proceedings of Speech Prosody 2002, Aix-en-Provence, France, 11-13 April*.  
 Fraser, Bruce. 1974. *The Verb-Particle Combination in English*. Tokyo: Taishukan.



- Göbbel, Edward. 2003. "On the Relation between Focus, Prosody and Word Order in Romanian". In J. Quer et al. (eds.), *Romance Languages and Linguistic Theory 2001*, 77-94. Amsterdam: Benjamins.
- Göbbel, Edward. in print. "Focus and Marked Positions for VP Adverbs". In K. Schwabe & S. Winkler (eds.), *On Information Structure, Meaning and Form*. Amsterdam: Benjamins.
- Gussenhoven, Carlos. 2005. "Procliticized Phonological Phrases in English: Evidence From Rhythm." *Studia Linguistica* 59: 174-93.
- Haider, Hubert. 1994. *Detached Clauses – The Later The Deeper*. Technical report 41, SFB 340. University of Stuttgart.
- Heim, Irene & Kratzer, Angelika. 1998. *Semantics in Generative Grammar*. Oxford: Blackwell.
- Huck, Geoffrey & Na, Younghee. 1990. "Extraposition and Focus". *Language* 66, 51-77.
- Kratzer, Angelika & Selkirk, Elisabeth. 2007. Phase Theory and Prosodic Spellout: The Case of Verbs. Ms., University of Massachusetts at Amherst.
- Ladd, Robert. 1992. "Compound Prosodic Domains". Edinburgh University Linguistics Department Occasional Paper.
- López, Luis. 2006. Ranking the LCA. Ms., ZAS Berlin.
- Rochemont, Michael. 1986. *Focus in Generative Grammar*. Amsterdam: Benjamins.
- Rochemont, Michael & Culicover, Peter. 1990. *English Focus Constructions and the Theory of Grammar*. Cambridge: CUP.
- Shaer, Benjamin. 2003. "'Manner' Adverbs and the Association Theory". In E. Lang et al. (eds.), *Modifying Adjuncts*, 211-59. Berlin: Mouton de Gruyter.
- Selkirk, Elisabeth. 1995. "The Prosodic Structure of Function Words". In J. Beckman et al. (eds.), *Papers in Optimality Theory*, 439-69. Amherst, Mass.: GLSA Publications.
- Selkirk, Elisabeth. 2000. "The Interaction of Constraints on Prosodic Phrasing". In M. Horne (ed.), *Prosody: Theory and Experiment*, 231-61. Dordrecht: Kluwer.
- Selkirk, Elisabeth. 2001. Phonological Weight in Sentence Grammar: Reexamining Heavy Noun Phrase Shift. Handout, *Workshop on Prosody in Processing*, 5-6 July 2001, Utrecht Institute of Linguistics OTS.
- Selkirk, Elisabeth. 2005. "Comments on Intonational Phrasing in English". In S. Frota et al. (eds.), *Prosodies: With Special Reference to Iberian Languages*, 11-58. Berlin: Mouton de Gruyter.
- Selkirk, Elisabeth & Kratzer, Angelika. 2005. Focuses, Phases and Phrase Stress. Handout, Mediterranean Syntax Meeting, Rhodes, June 23, 2005.
- Taglicht, Josef. 1998. "Constraints on Intonational Phrasing in English". *Journal of Linguistics* 34: 181-211.
- Truckenbrodt, Hubert. 1995. Extraposition from NP and Prosodic Structure. *NELS* 25, 503-17.
- Truckenbrodt, Hubert. 1999. On the Relation between Syntactic Phrases and Phonological Phrases. *Linguistic Inquiry* 30: 219-55.
- Wasow, Thomas. 2002. *Postverbal Behaviour*. Stanford University: CSLI Publications.

Edward Göbbel  
English Department, University of Tübingen  
edward.goebbel@uni-tuebingen.de

# More on DP-IP Parallelism: Turkic and Circassian Case

Pavel Grashchenkov

Institute of Oriental Studies (Moscow)

## 1. Introduction

The paper examines the story about the clause-noun phrase parallelism, started by the seminal works of Abney and Szabolsci. Possessives in the languages under issue exhibit very close similarity with subjects. The goal of the paper is to show that this is not arbitrary and DPs in Turkic<sup>1</sup> and Circassian<sup>2</sup> display some phenomena, traditionally attributed to the clause.

## 2. Syntactic Structures

### 2.1. Agreement

Turkic are accusative languages (direct objects may not receive case marking), in which the verb agrees with the subject in person and number:

(1) Tatar

|     |           |              |
|-----|-----------|--------------|
| min | alma-(ny) | al-dy-m      |
| I   | apple-Acc | take-Pst-1Sg |

*I took an apple.*

The agreement markers on nouns in Turkic possessives are the same:

(2) Tatar

|    |                |                           |                       |
|----|----------------|---------------------------|-----------------------|
| Sg | 1              | bar-dy- <b>m</b>          | alma- <b>m</b>        |
|    |                | 'I went'                  | 'my apple'            |
|    | 2              | bar-dy- <b>ŋ</b>          | alma- <b>ŋ</b>        |
|    |                | 'you went'                | 'your apple'          |
| Pl | 1              | bar-dy-k/bara- <b>byz</b> | alma- <b>byz</b>      |
|    |                | 'we went'                 | 'our apple'           |
|    | 2              | bar-dy- <b>gez</b>        | alma- <b>gyz</b>      |
|    |                | 'you went'                | 'your apple'          |
|    | 3 <sup>3</sup> | bar-dy- <b>Ø</b>          | alma- <b>sy</b>       |
|    |                | 'he/she/they went'        | 'his/her/their apple' |

<sup>1</sup> Turkic is a big family of languages with very stable and uniform grammar.

<sup>2</sup> Under Circassian I assume Adyghe, Circassian and Kabardian languages.

<sup>3</sup> 3<sup>rd</sup> person morpheme *-(s)e*; *-(s)y* stands for both singular and plural.

Circassian are polysynthetic ergative languages, the verb agrees with all its arguments (and non-arguments):

- (3) Circassian  
 λəʒə-m            sabij-m            məʔarəse-r    Ø-ji-ri-taš  
 old.man-Erg      child-Dat      apple-Abs    3Sg.DO-3Sg.IO-3Sg.Su-gave  
*The old man gave an apple to the child.*

Genitive and ergative cases in Circassian are expressed by the same marker. Agreement prefixes also coincide, except for the 3<sup>rd</sup> person singular:

- (4) Circassian (table by L.Bylinina.)
- |    |   |                   |                          |
|----|---|-------------------|--------------------------|
| Sg | 1 | <b>s</b> -ošeš    | <b>s<sub>j</sub></b> ane |
|    |   | 'I leaded'        | 'my mother'              |
|    | 2 | <b>w</b> -ošeš    | <b>w</b> ene             |
|    |   | 'you leaded'      | 'your mother'            |
|    | 3 | <b>j</b> (ə)-ošeš | <b>j</b> (i) ane         |
|    |   | 'he leaded'       | 'his/her mother'         |
| Pl | 1 | <b>d</b> -ošeš    | <b>d<sub>j</sub></b> ane |
|    |   | 'we leaded'       | 'our mother'             |
|    | 2 | <b>f</b> -ošeš    | <b>f<sub>j</sub></b> ane |
|    |   | 'you leaded'      | 'your mother'            |
|    | 3 | <b>ja</b> -šeš    | <b>ja</b> ane            |
|    |   | 'they leaded'     | 'their mother'           |

Let's leave behind the slight dissimilarities in agreement paradigms and turn to more serious problems in parallelism between clauses and noun phrases in these languages.

## 2.2. Differences in possessor agreement in Turkic and Circassian

Possessives in Turkic and Circassian may receive genitive or surface in the unmarked form in their base-generated position:

- |                                           |                                                |
|-------------------------------------------|------------------------------------------------|
| (5) <u>Tatar</u>                          | (6) <u>Circassian</u>                          |
| a. bu            agač            jafrag-y | a. me            žəg    q <sub>w</sub> edame   |
| this        tree            leaf-3        | this        tree    branch                     |
| b. agač-nyŋ    bu            jafrag-y     | b. žəg-əm    jə    ʔme    q <sub>w</sub> edame |
| tree-Gen    this        leaf-3            | tree-Gen    3Sg    this    branch              |
| <i>this leaf of a/the tree</i>            | <i>this branch of a/the tree</i>               |

The difference between Turkic and Circassian possessives is that in the former agreement does not depend on case assignment, whereas in the latter the two processes are synchronous, see the example above. Why it is so?

I argue that Turkic, in addition to the ordinary person-number agreement paradigm, have the light head *n*, surfaced as *-(s)e*; *-(s)y* which licenses the arguments expressed by non-pronominal 3<sup>rd</sup> person noun phrases. Thus, *-y* above is not an agreement marker, but light *n* morpheme. Personal nominal agreement in both groups of languages takes place on DP level.

### 2.3. Position of adjuncts

Adjectives in Circassian follow the noun whereas verbal modifiers usually adjoin on the left. Why Circassian DPs are not the same as IPs in this respect?

Some nominal adjuncts can either precede (preferred) or follow (dispreferred) the noun, cf. adjective (7) and ordinal numerals (8):

- (7) Circassian
- |    |       |           |    |           |       |
|----|-------|-----------|----|-----------|-------|
| a. | wəne  | daxə      | b. | ʔdaxə     | wəne  |
|    | house | beautiful |    | beautiful | house |
- (8) Circassian
- |    |        |      |    |      |        |
|----|--------|------|----|------|--------|
| a. | jexane | maze | b. | maze | jexane |
|    | sixth  | day  |    | day  | sixth  |
- (Kumakhov 1989)

I assume that Turkic is an instance of consistent left branching: all heads have their complements, specifiers and adjuncts left-generated. On the contrary, Circassian are subject to Kayne's (1994) LCA: they take complements on the right.

Then N-Adj order in Circassian is a result of N-movement, just as it has been argued for Romance in Bernstein (1993), Cinque (1993), Longobardi (1994), Dobrovie-Sorin (2000).

But the target position for movement in Circassian is lower than D, since the moved N: i) can be used with the definite pronoun and ii) can be separated from it by the possessive clitic (agreement holds at DP level):

- (9) Circassian
- |      |     |      |                             |           |
|------|-----|------|-----------------------------|-----------|
| (we) | a   | wi   | χžəğəbzc'žək <sub>w</sub> ' | daxə      |
|      | you | this | 2.Sg girl                   | beautiful |
- this beautiful girl of yours*

I suppose that N in Circassian moves to the small n position, cf. Chomsky (1995) V-to-v raising:<sup>4</sup>

- (10) Circassian
- 
- DP branches into Det (a) and D (wi). DP also branches into nP and N. nP branches into n (χžəğəbzc'žək<sub>w</sub>') and NP. NP branches into Adj (daxə) and N (N). A dashed arrow points from t<sub>i</sub> to the n head.

But head movement does not influence the surface word order in Turkic, where n head is to the right of NP complement:

- (11) Chuvash
- |                 |           |                 |                                  |                                    |
|-----------------|-----------|-----------------|----------------------------------|------------------------------------|
| [ <sub>nP</sub> | xitre     | [ <sub>NP</sub> | [ <sub>N</sub> t <sub>i</sub> ]] | [ <sub>n</sub> xer <sub>i</sub> ]] |
|                 | beautiful |                 |                                  | girl                               |

<sup>4</sup> Cf. also in this respect Pollock's examples of V raising in cases like *Jean embrasse souvent Marie*.

Cf. in this respect V movement parameter (see Belletti (1990), Vikner (1990), Matushansky (2006) and others).<sup>5</sup>

In sum: I, v and V in predication have D, n and N analogues in noun phrase. D is responsible for the agreement, n licenses arguments and serves as a landing site for head movement.

#### 2.4. “Transitive” Nominals

In case of two nominal arguments, the higher (external) DP receives genitive marking whereas the lower (internal) argument remains unmarked:

- |      |                   |                                   |      |                     |                                     |
|------|-------------------|-----------------------------------|------|---------------------|-------------------------------------|
| (12) | <u>Tatar</u>      |                                   | (13) | <u>Circassian</u>   |                                     |
|      | malaj- <b>nyŋ</b> | agač                              |      | sabij- <b>əm jə</b> | žəg q <sub>w</sub> edame            |
|      | boy-Gen           | tree                              |      | child-Gen 3Sg       | tree branch                         |
|      |                   | <i>the boy's branch of a tree</i> |      |                     | <i>the child's branch of a tree</i> |

I suppose that both arguments are generated inside nP projection. The external argument is merged in Spec, nP, where it receives the (possessive) theta-role and then moves higher to Spec, DP for agreement and case assignment. N head raises to n, which has the overt *-y* realization in Turkic and is  $\emptyset$  in Circassian. The internal arguments that fill the lexical valency of the head noun are in Spec, NP:

- |      |                   |                                                                                                                                                                     |
|------|-------------------|---------------------------------------------------------------------------------------------------------------------------------------------------------------------|
| (14) | <u>Tatar</u>      | [ <sub>DP</sub> boy <sub>i</sub> -Gen [ <sub>nP</sub> t <sub>i</sub> [ <sub>NP</sub> tree [ <sub>N</sub> t <sub>j</sub> ] [ <sub>n</sub> leaf <sub>j</sub> -y]]] D] |
| (15) | <u>Circassian</u> | [ <sub>DP</sub> child-Gen D [ <sub>nP</sub> t <sub>boy</sub> [ <sub>n</sub> leaf <sub>j</sub> - $\emptyset$ ] [ <sub>NP</sub> tree t <sub>j</sub> ]]]               |

Cf. vP-internal subject hypothesis, Koopman & Sportiche (1991), VP-shell proposal, Larson (1988) etc.

As can be seen from the example (13), internal arguments in Circassian precede the head noun contra the structure in (15). Another problem with the word order in Circassian noun phrases – why internal arguments are preposed to the noun?

As was argued in Baker (1996), DPs in polysynthetic languages can be treated as topics and polypersonal verbs – as clauses. Thus, X / XP distinction is not as evident as in other languages. One can speculate that the head nominal *tree* moves into the head n position together with its specifier *leaf*. This seems quite natural, since head nominals often form the single phonological word with their specifiers. Such arguments can not be modified; to make the modification possible, one should resort to the genitive DP:

- |      |                      |    |                                  |
|------|----------------------|----|----------------------------------|
| (16) | <u>Circassian</u>    |    | (exs. by A. Bogdanov)            |
| a.   | <məʔarəse-fe>        | b. | *məʔarəse    ?ef    fe           |
|      | apple-skin           |    | apple    tasty    skin           |
|      | <i>an apple-skin</i> | c. | məʔarəse    ?efə-m    jə    fe   |
|      |                      |    | apple    tasty-Gen 3Sg    skin   |
|      |                      |    | <i>the skin of a tasty apple</i> |

<sup>5</sup> There certainly remains the question (which I leave open) why there is no V-to-v movement in Circassian.

Then, it is important that adnominal arguments obey thematic hierarchy (see Cinque (1980), Valois (1991), Kolliakou (1999) on this topic). Possessors always receive genitive marking and ‘wholes’ (*tree* in (12-13)) remain in the lower unmarked positions and not vice versa:

- |      |                                 |       |                                     |                   |                               |
|------|---------------------------------|-------|-------------------------------------|-------------------|-------------------------------|
| (17) | <u>Tatar</u>                    |       | (18)                                | <u>Circassian</u> |                               |
|      | *agač-nyŋ                       | malaj | jafrag-y                            | *žəg-əŋ           | jə sabij q <sub>w</sub> edame |
|      | tree-Gen                        | boy   | leaf-3                              | tree-Gen          | 3Sg child branch              |
|      | <i>the boy's leaf of a tree</i> |       | <i>the child's branch of a tree</i> |                   |                               |

One can conclude from (17-18) that both n and N assign theta-roles.

Personal agreement in Turkic and Circassian results from feature checking between pronominal possessors in Spec, DP and D heads. As can be seen from below, the agreement is controlled by the external arguments expressed by the personal pronoun or possessive PRO:

- |      |                                           |          |                      |                        |
|------|-------------------------------------------|----------|----------------------|------------------------|
| (19) | <u>Tatar</u>                              |          |                      |                        |
| a.   | [ <sub>DP</sub> minem/PRO <sub>POSS</sub> |          | [ <sub>NP</sub> agač | jafrag]-ym]            |
|      | my/PRO                                    |          | tree                 | leaf-1Sg               |
| b.   | *[ <sub>DP</sub>                          |          | agač-nyŋ             | jafrag-ym]             |
|      |                                           |          | tree-Gen             | leaf-1Sg               |
|      | <i>my leaf of a tree</i>                  |          |                      |                        |
| (20) | <u>Circassian</u>                         |          |                      |                        |
| a.   | [se/PRO <sub>POSS</sub>                   | si       | [ <sub>NP</sub> žəg  | q <sub>w</sub> edame]] |
|      | my/PRO                                    | 1Sg      | tree                 | branch                 |
| b.   | *[ <sub>DP</sub>                          | žəg-əŋ   | si                   | q <sub>w</sub> edame]  |
|      |                                           | tree-Gen | 1Sg                  | branch                 |
|      | <i>my branch of a tree</i>                |          |                      |                        |

Note, that pro-drop is observed in both groups of languages, thus it is hard to establish, big PRO or small pro is present in possessive in (19-22):

- |      |                       |           |    |                   |             |
|------|-----------------------|-----------|----|-------------------|-------------|
| (21) | <u>Balkar</u>         |           |    |                   |             |
| a.   | (men)                 | kel-im    | b. | (meni)            | ustaz-ym    |
|      | I                     | came-1Sg  |    | my                | teacher-1Sg |
|      | <i>I came.</i>        |           |    | <i>my teacher</i> |             |
| (22) | <u>Circassian</u>     |           |    |                   |             |
| a.   | (se)                  | sə-šətš   | b. | (sə)              | si txəλ     |
|      | I                     | 1Sg-stand |    | my                | 1Sg book    |
|      | <i>I am standing.</i> |           |    | <i>my book</i>    |             |

I suppose that in both groups of languages n is responsible for the external argument merging and D – for personal agreement. In Turkic agreement of the 1-2<sup>nd</sup> person possessives differs from that of full noun phrases / 3<sup>rd</sup> person pronominals:

- |      |                |            |    |                    |            |
|------|----------------|------------|----|--------------------|------------|
| (23) | <u>Kazakh</u>  |            |    |                    |            |
| a.   | meniŋ          | kitab-(ym) | b. | kez-neŋ            | kitab-*(y) |
|      | my             | book-1Sg   |    | girl-Gen           | book-3     |
|      | <i>my book</i> |            |    | <i>girl's book</i> |            |

In Circassian N can raise to D and form a composit with the agreement markers:

(24) Circassian

|                   |                   |                    |                   |                    |                   |                    |                   |                    |                   |                  |                 |
|-------------------|-------------------|--------------------|-------------------|--------------------|-------------------|--------------------|-------------------|--------------------|-------------------|------------------|-----------------|
| si                | g <sub>wə</sub> / | wi                 | g <sub>wə</sub> / | jə                 | g <sub>wə</sub> / | di                 | g <sub>wə</sub> / | fi                 | g <sub>wə</sub> / | ja               | g <sub>wə</sub> |
| 1Sg               | heart             | 2Sg                | heart             | 3Sg                | heart             | 1Pl                | heart             | 2Pl                | heart             | 3Pl              | heart           |
| sg <sub>w</sub> / |                   | wig <sub>w</sub> / |                   | jəg <sub>w</sub> / |                   | dig <sub>w</sub> / |                   | fig <sub>w</sub> / |                   | jag <sub>w</sub> |                 |
| 1Sg.heart         |                   | 2Sg.heart          |                   | 3Sg.heart          |                   | 1Pl.heart          |                   | 2Pl.heart          |                   | 3Pl.heart        |                 |

*my / your / his(her) / our / your / their heart*

In sum: just like v/VP projections in clauses, n/NP projections form the predicative core, later merged under some functional head. The external argument, originated in Spec, v/nP moves to I/DP for case and agreement, the internal one remains in v/nP. Moreover, n, like unergative v, assigns an external theta-role and does not assign case to the internal argument.

### 3. Nominal Ph(r)ases

It is generally assumed that CPs and vPs are the best candidates for phases. According to Chomsky (2001), phases introduce chunks of information, enumerated, merged and sent to Spell-Out.

#### 3.1. Phonological Spell-Out

Phases “have a degree of phonetic independence” (Chomsky (2001)), see also Matushansky (2004), where the PF diagnostics has been argued to be the only evidence for the phasehood of DP.

In the languages under issue, structural case positions allow for non case-marked noun phrases:

(25) Tatar

|    |       |            |       |    |             |         |
|----|-------|------------|-------|----|-------------|---------|
| a. | malaj | šeger(-ne) | uk-yj | b. | malaj(-neŋ) | šeger-e |
|    | boy   | poem-Acc   | read  |    | boy-Gen     | poem-3  |

*The boy reads the/a poem.* *boy's poem*

(26) Circassian (ex. by A.Bogdanov)

|    |            |                       |              |    |               |          |
|----|------------|-----------------------|--------------|----|---------------|----------|
| a. | sabij(-əm) | ?iR <sub>w</sub> etaš | mə?arəse(-r) | b. | sabij(-əm jə) | mə?arəse |
|    | child-Erg  | found                 | apple-Abs    |    | child-Gen 3Sg | apple    |

*The boy found the/an apple.* *child's apple*

The absence of overt case may be considered as the lack of DP layer, that is confirmed by the inability to license genitives and relative clauses:

(27) Tatar

|       |                          |                                |      |
|-------|--------------------------|--------------------------------|------|
| malaj | [ <sub>DP</sub> [a-nyŋ]] | [ <sub>NP</sub> šeger-e]]*(-n) | ukyj |
| boy   | he-Gen                   | poem-3-Acc                     | read |

*The boy reads his poem.*

(28) Circassian (ex. by A.Bogdanov)

|           |                        |                                            |                              |
|-----------|------------------------|--------------------------------------------|------------------------------|
| sabij-əm  | ?iR <sub>w</sub> eta-š | [ <sub>DP</sub> [ <sub>NP</sub> mə?arəse]] | [?ex <sub>w</sub> exa]]*(-r) |
| child-Erg | found                  | apple                                      | fallen-Abs                   |

*The child found the fallen apple (the apple that fell).*

At the same time, adjectival modifiers are perfectly acceptable:

- |                                  |              |       |      |                                       |
|----------------------------------|--------------|-------|------|---------------------------------------|
| (29)                             | <u>Tatar</u> |       | (30) | <u>Circassian</u> (ex. by A.Bogdanov) |
| malaj                            | zur          | šeger | ukyj | ʔene daxe q'ex <sub>w</sub> ex-a-š    |
| boy                              | big          | poem  | read | table nice fell                       |
| <i>The boy reads a big poem.</i> |              |       |      | <i>A nice table fell.</i>             |

I will treat such caseless noun phrases as nPs. There are also some morphological restrictions on such nominals: for instance, they can not be used with plural markers:

- |                               |              |      |                                |                                       |
|-------------------------------|--------------|------|--------------------------------|---------------------------------------|
| (31)                          | <u>Tatar</u> |      | (32)                           | <u>Circassian</u> (ex. by A.Bogdanov) |
| malaj                         | šeger(*-ler) | ukyj | Sabij-əm                       | ʔiR <sub>w</sub> eta-š məʔarəse(*-xe) |
| boy                           | poem-Pl      | read | child-Gen                      | found apple-Pl                        |
| <i>The/a boy reads poems.</i> |              |      | <i>The child found apples.</i> |                                       |

The latter constraint follows directly, if NumP is somewhere between the nP and DP levels.

Then, the Circassian languages has no lexical classes:

- |                      |                   |                                       |                     |         |
|----------------------|-------------------|---------------------------------------|---------------------|---------|
| (33)                 | <u>Circassian</u> |                                       | (ex. by A.Bogdanov) |         |
| a.                   | Š'ale-r           | žə-š                                  | b. Žə-r             | š'ale-š |
|                      | boy-Abs           | run-Ind                               | run-Abs             | boy-Ind |
| <i>The boy runs.</i> |                   | <i>The one, who runs, is the boy.</i> |                     |         |

The only difference between N and V projections is that the former but not the latter may drop case markers:

- |                    |                   |                                 |                     |                       |
|--------------------|-------------------|---------------------------------|---------------------|-----------------------|
| (34)               | <u>Circassian</u> |                                 | (ex. by A.Bogdanov) |                       |
| a.                 | Š'ale             | q'eķ <sub>w</sub> a-š           | b. *Žə              | q'eķ <sub>w</sub> a-š |
|                    | boy               | came-Ind                        | run                 | came-Ind              |
| <i>A boy came.</i> |                   | <i>The one, who runs, came.</i> |                     |                       |

As I suppose, the reason for this is that only nominal projections may fill argument positions. This may be an nP/DP or a vP inside the DP shell, but not a bare vP. See also Radford (2000), Matushansky (2004), Svenonius (2004) on nominal phase proposal.

### 3.2. Edge effects: Circassian

Then, if phases are local cyclic domains which can be sent to Spell-Out, the peripheral (topic and focus) effects are expected on the edges of phases, see Svenonius (2004).

In Circassian “transitive” noun phrases can not be coded by two genitives:

- |                                     |                   |          |     |                      |
|-------------------------------------|-------------------|----------|-----|----------------------|
| (35)                                | <u>Circassian</u> |          |     |                      |
| *sabij-əm                           | jə                | žəg-əm   | jə  | q <sub>w</sub> edame |
| child-Gen                           | 3Sg               | tree-Gen | 3Sg | branch               |
| <i>the child's branch of a tree</i> |                   |          |     |                      |



Since Circassian are wh-in-situ languages, the only option expected in questions to one of the arguments is to replace this argument with the wh-word. But another possibility, the double-genitive marking, arises here:

(36) Circassian

- a. xet                      jə              žəg-əm              jə              q<sub>w</sub>edame  
     who.Gen              3Sg              tree-Gen              3Sg              branch  
*who's branch of a tree*
- b. sət-əm                    jə              sabij-əm              jə              q<sub>w</sub>edame  
     what-Gen              3Sg              tree-Gen              3Sg              branch  
*childs's branch of what*

I suppose that such noun phrases have a peripheral layer above DP, which is headed by the agreement clitic and has a wh-word in Spec position:

(37) Circassian

[<sub>FocP</sub> wh-word<sub>.Gen</sub> [<sub>Foc</sub> jə] [<sub>DP</sub> possessive<sub>.Gen</sub> [<sub>D</sub> jə] [...]]]

The same holds for relativization: the relativizer, which is put in the position of the moved argument, signals that the second genitive DP (the head of relative clause) was in the structure:

(38) Circassian

šəp'e<sub>i</sub> [<sub>TopP</sub> t<sub>i</sub> zi [<sub>DP</sub> geolog-əm jə t<sub>i</sub> plan]] stoləm teλa...  
     site                      Rel      geologist-Gen 3Sg      plan      table.on lay  
*Site, geologist's plan of which is on the table, ...*

Thus, we can postulate some TopP, FocP projections above DP, responsible for the (discourse-driven) extraposition of nominal arguments, cf. Rizzi (1997) proposal on the elaborated left periphery in clauses (see also Ntelitheos (2004)).

In sum: we saw that not only DPs but also some DP-internal nPs may be considered nominal phases.

#### 4. Information structure in nominals

Topic-comment structure is usually attributed to sentences, cf. Russian:

(39) Russian

- a. Pet'a    prishel.                      b.      Prishel                      Pet'a  
     Peter    came                              came                              Peter  
*Peter came.                                      The one, who came, is Peter.*

In DPs the unmarked order corresponds to non-split I(nformation) S(tructure): both a noun and an adjective display either old, topic-like, or new, focus-like, information. In English IS can change prosodically:

(40)

- a. *I like the ripe apples.*                      b. *I like ripe apples.*  
 c. *I like RIPE apples (not green ones).*    d. *I like ripe APPLES (not plums).*

Below I discuss Turkic and Circassian DPs in which a noun (phrase) is turned to topic whereas adjective serves as a comment.

#### 4.1. Turkic

Turkic languages possess constructions, in which the modifier-modified relations are inverted, (cf. *that idiot of a mayor*, den Dikken (1998)):

(41) Tatar  
 žufär                    agač-lar-nyŋ                    bijek-e-n                    utyr-ty  
 Zufer                    tree-Pl-Gen                    high-3-Acc                    plant-Pst  
*Zufer planted the (most) high tree (among the trees).*

The postposition of adjective here is odd as well as the genitive on the noun, since: first – there is no right branching in Turkic and second – only nominal projections assign genitives.

Such constructions always have the restrictive (and not obligatory definite / specific) interpretation. In ordinary noun phrases, *bijek agač*, *the/a high tree(s)* the semantics of the whole construction is a result of intersection of the two predicates, *high* and *tree*. At the same time, in modifier-inversion constructions denotation relies on the adjective *bijek-e*, whereas the type of denoted objects is pre-specified.

Nouns in such constructions seem to have contrastive topic interpretation: *Among the TREES, Zufer planted the high (the highest) ones.*

It is evident that the adjective with the affix *-e* does not undergo substantivation (i.e. it is not created in the lexicon), since it can not take adnominal modifiers. Only adjectival intensifiers are possible:

(42) Tatar  
 agač-nyŋ                    (ʎbik / \*ike)                    bijek-e  
 tree-Gen                    (very                    two)                    high-3  
*the very high of the trees / \*two high of the trees*

I suppose that both types of constructions arise to “plain” small clauses inside DPs (see Stowell (1983), Pereltsvaig (2000)), as shown in (43):<sup>6</sup>

(43) Tatar  
 [DP [SC [TOPIC (*noun phrase*) ]                    [COMMENT (*AP*) ]<sub>SC</sub>] D]  
 [DP [DP *agač*]-nyŋ]<sub>(Gen)</sub>                    [SC *t*                    [AP *bijek*]<sub>SC</sub>] D-*e*]-*n*<sub>(Acc)</sub>

Subjects in the adjective inversion constructions raise from the Spec of SC to the Spec, DP position where they receive genitive under agreement with D head. The SC is responsible for the IS change (cf. Basilico (2003)) and the case is assigned to the external DP shell.

<sup>6</sup> Cf. also Bernstein’s (1993) structure (80), p. 47.

## 4.2. Circassian

As was argued in Sumbatova (2005), there are very regular topicalized structures in Adyghe, formed by putting the subject (topic) and the predicate (comment) both in the same (absolutive) case:

- (44) Adyghe (Sumbatova (2005))  
 [Ihan<sub>Wə</sub>R<sub>Wə</sub>pčə-r xəzəwətəRe]-r [R<sub>Wə</sub>neR<sub>Wə</sub>]-r ep / arə  
 window-Abs broke-Abs neighbor-Abs not that  
*It is (not) the neighbor who broke the window.*

Mostly such clauses are attested in equative contexts, the presence of *ep* / *arə* ('not' / 'that') is obligatory:

- (45) Adyghe (ex. by E.Kalinina)  
 tɣamatešx<sub>w</sub>e-r \*(arə) siŋe-r  
 big.boss-Abs that my.husband-Abs  
*This big boss is my husband.*

DPs in the languages of the Circassian family display a similar phenomenon: when the relative clause is postposed to the head noun, both the noun and the relative can receive the same case value:

- (46) Circassian (ex. by A.Bogdanov)  
 Š'alec'ək<sub>w</sub>ə-m q'iR<sub>w</sub>eta-š [mə'arəse]-r [ade-m q'i'epəx<sub>w</sub>-a]-r  
 boy-Erg found-Ind apple-Abs father-Erg let.fall-Pf-Abs  
*The boy found the apple, which (the one that) his father drop.*

In such constructions a noun phrase and a relative clause can not be split, hence, they form the single constituent:

- (47) Circassian (ex. by A.Bogdanov)  
 \*Š'alec'ək<sub>w</sub>ə-m f'əwe jeŋaR<sub>w</sub> [mə'arəse-xe-r  
 boy-Erg love sees apple-PI-Abs  
**x<sub>w</sub>abžū** ade-m q'iReč'axe]-r  
 very father-Erg grown-Abs  
*The boy very much likes the apples grown by his farther.*

I argue that it is equative bare SC that underlies both double-absolutive clauses and double case DPs. I assume that in case of clause, bare phrases are merged under the copular *ep* / *arə* in I, which assigns absolutive to both SC subject and predicate due to Relativized Minimality, (Pereltsvaig 2000):

- (48) Circassian
- 
- I  
|  
I  
arə
- SC
- absolutive
- [Ihan<sub>Wə</sub>R<sub>Wə</sub>pčə-r xəzəwətəRe]-r  
the one who broke the window-Abs
- [R<sub>Wə</sub>neR<sub>Wə</sub>]-r  
neighbor-Abs

In case of DP, bare SCs are merged under D thus both parts of them are also accessible to “external” case, assigned to the whole DP:

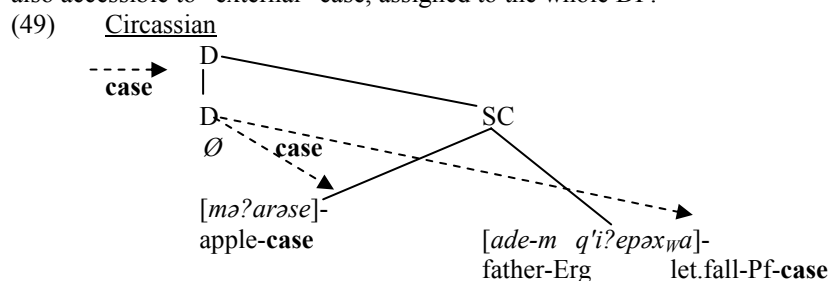

In sum: In Turkic and Circassian D as well as I can take SC complements. DPs and IPs display syntactic processes governed by the same communicative rules.

## 5. Conclusion

As we saw, D in Turkic and Circassian noun phrases is a strict analogue to I in predications. Moreover, there are some good evidences that there is a light n head which is responsible for theta-role assignment and serves as a landing site for head N movement. Then, nPs as well as DPs may be considered nominal phases. Finally, noun phrases in Turkic and Circassian can contain SCs and may rearrange their syntactic structure under the needs of pragmatics.

I leave the question whether DP and IP are construed by the same rules in languages with less “subject-like” possessors, such as for instance French or Russian, for future researches.

## References

- Baker, M. C. 1996. *The Polysynthesis Parameter*. New York: Oxford University Press.
- Basilico, D. 2003. “The Topic of Small Clauses”, *Linguistic Inquiry*, 34, 1: 1-35.
- Belletti, A. 1990. *Generalized verb movement*. Turin: Rosenberg and Tellier.
- Bernstein, J. 1993. *Topics in the syntax of nominal structure across Romance*. Ph.D. thesis, City University of New York.
- Butler, J. 2004. *Phase Structure, Phrase Structure, and Quantification*. PhD thesis, York.
- Chomsky, N. 1995. *The Minimalist Program*. Cambridge: The MIT Press.
- Chomsky, N. 2001. “Derivation by Phase”, M. Kenstowicz (ed.), *Ken Hale: a life in language*: 1-53, Cambridge: The MIT Press.
- Cinque, G. 1993. “On the Evidence for Partial N Movement in the Romance DP”, Giusti G. and L. Bruge (eds.), *University of Venice Working Papers in Linguistics* 3, 2: 21-40.

- den Dikken, M. 1998. "Predicate Inversion in DP", A. Alexiadou & C. Wilder (eds.), *Possessors, Predicates and Movement in the determiner Phrase*, Amsterdam: Benjamins.
- Dobrovie-Sorin, C. 2001. "Génitifs et déterminants", G. Kleiber, B. Laca & L. Tasmowski (eds.), *Typologie des groupes nominaux*: 205-235, Rennes: Presses Universitaires de Rennes.
- Kayne, R. 1994. *The Antisymmetry of Syntax*. Cambridge: MIT Press.
- Kolliakou, D. 1999. "De-phrase extractability and individual / property denotation", *Natural Language and Linguistic Theory*, **17**: 713-781. Dordrecht: Kluwer Academic Publishers.
- Koopman, H. & D. Sportiche. 1991. "The position of subjects", *Lingua*, **85**: 211-258.
- Kumakhov, M.A. 1989. *Sravnitel'no-istoričeskaja grammatika adygskich (čerkesskix) jazykov* [=A comparative-historical grammar of the Circassian languages]. Moskva: Nauka.
- Larson, R. 1988. "On the Double Object Construction", *Linguistic Inquiry*, **19**: 335-391.
- Longobardi, G. 1994. "Reference and Proper Names: A Theory of N-movement in Syntax and Logical Form", *Linguistic Inquiry*, **25**: 609-65.
- Matushansky, O. 2004. "Going through a phase", McGinnis, M. & N. Richards (eds.), *Perspectives on Phases. MIT Working Papers in Linguistics*, **49**. Cambridge: MIT Press.
- Matushansky, O. 2006. Head-movement in linguistic theory, *Linguistic Inquiry*, **37**: 69-109.
- Ntelitheos, D. 2004. *Syntax of Elliptical and Discontinuous Nominals*. PhD thesis, University of California, Los Angeles.
- Pereltsvaig, A. 2000. "Are All Small Clauses Created Equal? Evidence from Russian and Italian", M. Yoo and J. Steele (eds.), *McGill Working Papers in Linguistics* **15**, 1: 73-104.
- Radford, A. 2000. "Np Shells", *Essex Research Reports in Linguistics*, **33**: 2-20, University of Essex.
- Rizzi, L. 1997. "The Fine Structure of the Left Periphery", L. Haegeman (ed.), *Elements of Grammar*: 281-337, Dordrecht: Kluwer.
- Stowell, T. 1983. "Subjects across categories", *The Linguistic Review*, **2**: 285-312.
- Sumbatova, N. 2005. "Information Structure and Clause Combining in Adyge", [http://www.circassianworld.com/handout\\_Sumbatova.pdf](http://www.circassianworld.com/handout_Sumbatova.pdf)
- Svenonius, P. 2004. "On the Edge", Adger, D. & C. de Cat (eds.), *Peripheries: Syntactic Edges and their Effects*: 261-287, Dordrecht: Kluwer.
- Valois, D. 1991. "The Internal Syntax of DP and Adjective Placement in French and English" *NELS* **21**: 367-380.
- Vikner, St. 1990. *Verb Movement and the Licensing of NP Positions in the Germanic Languages*. PhD thesis, University of Geneva.

Pavel Grashchenkov  
 Institute of Oriental Studies  
 Moscow, 1-ja Dubrovskaja, 8/12, 85  
 gra-paul@mail.ru

# An Entailment Account of Scope Parallelism

**Seungwan Ha**  
Boston University

## 1 Parallel Scope

When a sentence contains more than two quantifiers, it becomes ambiguous. For example, in (1a), the existential quantifier can take narrow or wide scope, compared to the universal quantifier by quantifier raising, so that (1a) yields scope ambiguity. On the other hand, (1b) is not ambiguous since there exists only one quantifier in a sentence.

- (1) a. A girl loves every professor. ( $\exists > \forall$ ,  $\forall > \exists$ )  
 b. Mary loves every professor. (Not ambiguous)

The availability of quantifier movement has been generalized by Fox (1995, 2000), where he argues that Quantifier Raising (or Lowering) occurs only if it has a semantic effect (i.e. *Scope Economy*). Therefore, in (2b), quantifier can be reconstructed to its original position since it would affect the existential quantifier take narrow scope, compared to the universal quantifier.

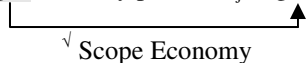
- (2) a.  $[_{TP} \text{A girl}_i [_{VP} \text{every professor}_j [t_i \text{ loves } t_j]]]$ .  
 b.  $[_{TP} \text{A girl}_i [_{VP} \text{every professor}_j [\text{a girl loves } t_j]]]$ .
- 
  
 $\checkmark$  Scope Economy

In (3), the QR of the universal quantifier does not have any semantic effect, so it is blocked by Scope Economy. Thus, only surface scope is available in (1b).

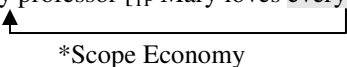
- (3)  $*[_{TP} \text{every professor } [_{TP} \text{Mary loves every professor.}]]]$
- 
  
 \*Scope Economy

Fox (2000) lists some examples that are scopally informative and uninformative in (4-5).

## (4) Scopally uninformative

- a. The person who produced the film festival admires every movie.  
 b. John and Bill like every teacher.

(Fox 2000: 41)

## (5) Scopally informative

- a. An American flag is in front of many buildings.  
 b. John or Bill likes every teacher.

(Fox 2000: 41)

A great amount of attention has been paid to scope ambiguity in the ellipsis contexts since Sag (1976) and Williams (1977). Sag (1976) and Williams (1977) discover a non-quantifier subject in the first conjunct fixes the scope of the multiple quantifiers in the second conjunct. For example, as we have discussed above, when two quantifiers exist in (6a), it becomes ambiguous. On the other hand, when an unambiguous sentence follows in the second conjunct, the scope ambiguity in the first conjunct disappears. Sag and Williams argue that it is due to a constraint, called *Scope Parallelism*. Since the second conjunct has to take narrow scope, compared to the non-quantifying subject, the first conjunct must do the same thing.

- (6) a. Some kid likes every football player. (ambiguous)  
 b. Some kid likes every football player, and Chris does, too. (unambiguous)

Let us examine how scope in (6b) is disambiguated. As (7) shows, surface scope is a possible configuration. On the other hand, inverse scope is not a possible configuration since the QR of the universal quantifier in the second conjunct would violate Scope Economy, as shown in (8).

- (7)  $[_{TP} \text{Some kid}_i [_{VP} \text{every football player}_j [t_i \text{ likes } t_j]]]$ , and  $[_{TP} \text{Chris}_i [_{VP} \text{every football player}_j [t_i \text{ likes } t_j]]]$ .  $(\exists > \forall)$

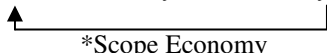
- (8)  $[_{TP} [_{VP} \text{every football player}_j [\text{Some kid likes } t_j]]]$ , and  $[_{TP} [_{VP} \text{every football player}_j [\text{Chris}_i \text{ likes } t_j]]]$ .  
  
 $(*\forall > \exists)$

It is not just limited to VP ellipsis contexts. Sluicing has an effect in disambiguating the first conjunct (Merchant 2001). Consider (9). The first conjunct is ambiguous, but the movement of wh-word in the second conjunct makes only wide scope reading possible.

(9) John said he wanted to buy a car, but he didn't tell us which one.

(a > want, \*want > a)

What would happen if both conjuncts contain multiple quantifiers? Hirschbühler (1982) argues that the scope-taking must be parallel between the conjuncts, either both universals take narrow scope or both take wide scope (Hirschbühler 1982, Rooth 1992, Fox 1995, 2000). For example, while (10a) and (10b) are possible, (10c) or (10d) is not, due to the mixed scopes (narrow-wide, wide-narrow).

(10) Some girl watched every recent movie, and some boy did too.

a.  $\exists > \forall$  &  $\exists > \forall$  (both conjuncts take surface scope)

b.  $\forall > \exists$  &  $\forall > \exists$  (both conjuncts take inverse scope)

c. \* $\exists > \forall$  &  $\forall > \exists$  (\*Parallel scope)

d. \* $\forall > \exists$  &  $\exists > \forall$  (\*Parallel scope)

Examples in (11) are other typical cases where scope parallelism works. Since each conjunct contains more than one quantifier, QR can occur in each conjunct. Crucially, QR is constrained in the way that the scopes between the conjuncts are parallel.

(11) a. A Canadian flag is in front of every building, and an American flag is, too. ( $\exists > \forall$ ,  $\forall > \exists$ )

b. One student knows the capital of every country. Many teachers do, too. ( $\exists > \forall$ ,  $\forall > \exists$ )

c. A boy was introduced to every professor and a girl was to every parent. ( $\exists > \forall$ ,  $\forall > \exists$ )  
(Fox 2000:30)

To generalize when scope is ambiguous or unambiguous in the ellipsis contexts, Fox (2000) proposes Ellipsis Scope Generalization in (12).

(12) Ellipsis Scope Generalization (ESG):

A sentence S will disambiguate its syntactic image S' (in favor of surface scope), whenever S is semantically equivalent under surface and inverse scope (i.e. whenever S is scopally uninformative)

(Fox 2000: 34)

Meanwhile, it appears to be the case that scope must be parallel in coordination even in non-ellipsis contexts. For example, in (13), even though no ellipsis is involved, the scope must be parallel. Thus, Asher, Hardt, and Busquets (2001) claim that Fox's ESG undergenerates.



(13) John gave every student a test, and Bill gave every student a project.

$(\exists > \forall, \forall > \exists)$

(Asher, Hardt, & Busquests 2001)

With this background, in the next section, I will address interesting scope possibilities where parallelism constraints appear to be disobeyed, due to Fox (1995, 2000).

## 2 Accommodation

### 2.1 Direct and indirect parallelism

There is an interesting contrast in scope-taking possibilities between (14) and (15), observed by Fox (1995, 2000). Fox (2000) argues that (14) is unambiguous. Only wide scope is available. On the other hand, (15) is ambiguous.

(14) At least one boy admires every teacher and Mary does too.  $(\exists > \forall, * \forall > \exists)$

(15) Mary admires every teacher and at least one BOY does too.  $(\exists > \forall, \forall > \exists)$

Following Rooth (1992), and Tancredi (1992), Fox (2000) assumes that there are two kinds of parallelism. Direct Parallelism (DP) states that the LF of a sentence that contains the elided material E is structurally isomorphic to a sentence that contains the antecedent A. Indirect Parallelism (IP) states that A (together with shared presuppositions) entails an LF of the antecedent A', and A' is structurally isomorphic to E.

Let us consider (14). Taking wide scope is possible, as shown in (16a), satisfying Direct Parallelism conditions. However, taking narrow scope would violate Scope Economy. As a result, it does not satisfy DP in (16b).

(16) a. At least one boy<sub>i</sub> [every teacher<sub>j</sub> [t<sub>i</sub> admires t<sub>j</sub>]] and Mary<sub>k</sub> [every teacher<sub>j</sub> [t<sub>k</sub> admires t<sub>j</sub>]]

(=14)

$(\exists > \forall, \text{ satisfied by DP})$

b. \*Every teacher<sub>j</sub> [at least one boy<sub>i</sub> [t<sub>i</sub> admires t<sub>j</sub>]]

and every teacher<sub>j</sub> [Mary<sub>k</sub> [t<sub>k</sub> admires t<sub>j</sub>]]

↑

\*Scope Economy

$(* \forall > \exists, * \text{DP})$

To see if (16b) satisfies Indirect Parallelism constraints, we need to discuss what triggers accommodation, so that we could consider a presupposed LF structure of the antecedent to be structurally parallel to that of the ellipsis site.

## 2.2 Accommodation triggers

According to Fox (2000), accommodation of antecedent by Indirect Parallelism must have a trigger. Fox (2000) claims that accommodation is triggered, when the elided clause contains non-F-dominated material that is absent in antecedent.

By definition, Fox predicts (17) to be ambiguous since there is a non-F-marked material in the subject of the second conjunct. The subject of the second conjunct is *at least one BOY* where *at least one* is not focus-marked. Therefore, *at least one* serves as a trigger for presupposition accommodation. The LF of the antecedent would be ‘for every professor y, there is a girl x, in fact Mary, such that x talked to y.’ And this presupposed antecedent is parallel to narrow scope for *every professor* in the elided part.

On the other hand, accommodation is not triggered in (18) since there is no non-F-marked element in the subject of the second conjunct. Note that in (18) the whole subject in the second conjunct *AT LEAST ONE BOY* is focused-marked.

(17) MARY talked to every professor, and at least one BOY did too.  
(At least one >  $\forall$ ,  $\forall$  > at least one)

(18) MARY talked to every professor, and AT LEAST ONE BOY did too.  
(at least one >  $\forall$ , \* $\forall$  > at least one)  
(Fox 2000:103)

Let us return to (14). According to Fox (2000), accommodation is not relevant in (14), mainly because *Mary* is focused, so accommodation is not triggered. In addition, the antecedent can take both wide and narrow scope, regardless of accommodation. Therefore, conditions for Indirect Parallelism are not satisfied, and only wide scope is possible in (19).

(19) \*Every teacher<sub>j</sub> [at least one boy<sub>i</sub> [t<sub>i</sub> admires t<sub>j</sub>]]  
and every teacher<sub>j</sub> [Mary<sub>k</sub> [t<sub>k</sub> admires t<sub>j</sub>]] (=14)  
↑  
\*Scope Economy  
(\* $\forall$  >  $\exists$ , \*IP)

Now let us consider (15). Supposed that *boy* in the subject of the second conjunct is focused. Here we can argue that accommodation is triggered since there is non-F-marked *at least one* in the ellipsis clause. Therefore, Indirect Parallelism is available, as shown in (20b’). A presupposed LF structure follows ‘for every teacher y, there is a girl x, in fact Mary, such that x admires y.’ Crucially, it is parallel to the elided clause.

- (20) a. Mary<sub>k</sub> [every teacher<sub>j</sub> [t<sub>k</sub> admires t<sub>j</sub>]] and at least one BOY<sub>i</sub> [every teacher<sub>j</sub> [t<sub>i</sub> admires t<sub>j</sub>]] (= 15, satisfying DP)  
 b. Every teacher<sub>j</sub> [Mary admires t<sub>j</sub>] and every teacher<sub>j</sub> [at least one BOY admires t<sub>j</sub>] (\*DP)

By presupposition accommodation:

- b'. Every teacher<sub>j</sub> [a girl (= Mary) admires t<sub>j</sub>] and every teacher<sub>j</sub> [at least one BOY admires t<sub>j</sub>] (satisfying IP)

An immediate question could arise to Fox's accommodation, namely, why only the antecedent is able to be eligible for accommodation. In other words, why can't the elided part accommodate E', an LF of the elided part? If so, inverse scope should be possible when non-F-marked material is available in the subject of the first conjunct as in (21).

- (21) [Every teacher<sub>j</sub> [some BOY<sub>i</sub> [t<sub>i</sub> admires t<sub>j</sub>]]] and [Every teacher<sub>j</sub> [a girl (= Mary) admires t<sub>j</sub>]] (∀ > ∃, by IP)

In fact, there have been other attempts to deal with these facts in the literature. Asher, Hardt, & Busquets (2001), Asudeh & Crouch (2002), Jacobson (1998), Johnson and Lappin (1997, 1999) argue that Fox's ESG does not capture the inverse scope possibilities for the following examples. Their criticism on the ESG is that the non-quantifier subject in the ellipsis clause fails to fix the scope of the antecedent clause sometimes. However, what is more interesting here is that (22-24) look similar to (14) but ambiguous.

- (22) Every student read a book and Harry did, too. (Ambiguous)  
 Asher, Hardt, & Busquets (2001)
- (23) Several waiters knew every customer. Chef Pierre did, too. (Ambiguous)  
 (Asudeh & Crouch 2002: 2)
- (24) At least one Labour MP attended most committee meetings, and Bill did, too. (Ambiguous)  
 (Johnson & Lappin 1997)

I will get back to (22-24) in section 4 after I propose my alternative account for Scope Parallelism.

The distinction between (14) and (15) appears to hold in Right Node Raising as well. (25a) is not ambiguous since accommodation is not triggered, but (25b) is ambiguous since there is a non-F-marked *some*, which triggers accommodation for the antecedent clause.

- (25) a. MARY DISRESPECTS, but SOME BOY ADMIRES every teacher.  
 ( $\exists > \forall$ ,  $*\forall > \exists$ )  
 b. Some BOY DISRESPECTS, but MARY ADMIRES every teacher.  
 ( $\exists > \forall$ ,  $\forall > \exists$ )

In section 2, a conceptual problem for Fox's accommodation hypothesis has been raised, namely why the elided clause cannot be accommodated. In section 3, I will argue that Fox's hypothesis also overgenerates.

### 3 Problems for Fox's proposal

As shown in the previous examples, parallel scope-taking in (26a-b) is possible but not non-parallel scope-taking in (26c-d).

- (26) Some student met every teacher, and at least one parent did too.  
 a.  $\exists > \forall$  & *at least one*  $> \forall$   
 b.  $\forall > \exists$  &  $\forall >$ *at least one*  
 \*c.  $\exists > \forall$  &  $\forall >$ *at least one*  
 \*d.  $\forall > \exists$  & *at least one*  $> \forall$

If we assume *parent* is focused, *at least one* can be considered non-F-dominated material in (27). Thus, accommodation can be triggered.

- (27) SOME STUDENT met every teacher, and at least one PARENT did ~~<meet every teacher>~~ too.  
 a.  $\exists > \forall$  & *at least one*  $> \forall$  (satisfying DP)  
 b.  $\forall > \exists$  &  $\forall >$ *at least one* (satisfying DP)  
 \*c.  $\exists > \forall$  &  $\forall >$ *at least one* (\*DP, satisfying IP)  
 \*d.  $\forall > \exists$  & *at least one*  $> \forall$  (\*DP, \*IP)

(27a-b) satisfy Direct Parallelism. (27c) is predicted to be available in Fox (2000) since  $\forall > \exists$  can be accommodated from given  $\exists > \forall$ , which is exactly the same configuration with (27b). Since non-focus marked *at least one* can serve as an accommodation trigger, the antecedent entails 'for every teacher y, there is a student x, such that x met y ( $\forall > \exists$ ). This accommodated antecedent ( $\forall > \exists$ ) is structurally isomorphic to the second conjunct in (27c). Therefore, the configuration of (27c) is predicted to be available in Fox (2000). In (27d), Direct Parallelism is not possible, since the structures are not parallel. Indirect Parallelism is not available, either, since accommodation is not possible here. That is,  $\forall > \exists$  does not entail  $\exists > \forall$ . The universal quantifier in the first conjunct does not have to undergo QR to be parallel.

Therefore, we face paradox. Any trigger for this type of accommodation, which allows inverse scope for examples, such as (17) and (20), must at the same time rule out (27c). The problem lies on the fact that (27) contains a focused quantifier subject.

To resolve the problems above, I propose an alternative account in section 4.

#### 4 An Entailment account

Rather than relying on Fox's two constraints on Scope Parallelism (i.e. Direct Parallelism and Indirect Parallelism), I propose that Scope Parallelism is reduced to mutual entailment relationship between the antecedent and the elided part after QR. I will call this *an ellipsis account* for Scope Parallelism.

Here is my first attempt for generalization in (28).

(28) Entailment account for Scope Parallelism (*First hypothesis*)

- a. The focus constituent in the antecedent and the elided part are existentially closed, i.e. modulo  $\exists$ -type shifting.
- b. After QR, the conjuncts must mutually entail each other.

In (29), *student* and *parent* are focused, and they are subject to F(ocus)-closure, but crucially, quantifiers still remain after F-closure since they are not within the F-marked domain.

(29) Some STUDENT met every teacher, and at least one PARENT did too.

$[[29]]^f = \exists x. \text{some } x \text{ met every teacher, and } \exists y. \text{at least one } y \text{ met every teacher}$

a.  $\exists > \forall \leftrightarrow \text{at least one} > \forall$

b.  $\forall > \exists \leftrightarrow \forall > \text{at least one}$

\*c.  $\exists > \forall \rightarrow \forall > \text{at least one}$ ,  $*\exists > \forall \leftarrow \forall > \text{at least one}$

\*d.  $*\forall > \exists \rightarrow \text{at least one} > \forall$ ,  $\forall > \exists \leftarrow \text{at least one} > \forall$

Under the entailment account, we can easily explain why (29c-d) are not available scope-taking possibilities, in that the LF of the second conjunct fails to entail that of the first conjunct. (29a-b) are predicted to be possible since the first and the second conjuncts have identical scope configurations. Consequently, LFs of the two conjuncts entail each other.

Mutual entailment is not relevant to the following examples in (30). *Mary* and *boy* are focused in (30). After F-closure, two quantifiers in the second conjunct still remains and they are eligible to undergo QR.

(30) MARY talked to every professor, and at least one BOY did too.

(At least one >  $\forall$ ,  $\forall$  > at least one)

$[[30]]^f = \exists x. x \text{ talked to every professor, and } \exists y. \text{ at least one } y \text{ talked to every professor.}$

- a.  $\exists x. x \text{ talked to every professor, and } \exists y \text{ [every professor}_i \text{ [at least one } y \text{ talked to } t_i]]$  ( $\forall$  > at least one)
- b.  $\exists x. x \text{ talked to every professor, and } \exists y \text{ [at least one}_j \text{ [every professor}_i \text{ [} t_j \text{ } y \text{ talked to } t_i]]]$  (at least one >  $\forall$ )

On the other hand, the first conjunct cannot take inverse scope due to the violation of Scope Economy. It is crucial that I assume that mutual entailment does not matter when one of the conjuncts is scopally rigid. Otherwise, (30a) would not be available since the antecedent and elided clause do not mutually entail each other. I will leave it open for future research regarding why that should be. In the second conjunct, the two non-focused quantifiers can undergo QR, regardless of the impossible QR option in the first conjunct. Thus, both scope possibilities are available in (30). Therefore, we need to revise for my previous account as in (31).

(31) Entailment account for Scope Parallelism (*Revised*)

- a. The focus constituent in the antecedent and the elided part are existentially closed, i.e. modulo  $\exists$ -type shifting.
- b. After QR, in case each conjunct contains multiple quantifiers, the conjuncts must mutually entail each other.
- c. If in a conjunct QR does not result in a change of the truth conditions, each conjunct undergo QR independently.

Let us take (32). Here *some boy* in the first conjunct and *girl* in the second conjunct are focused. What is important to notice is that the quantifier in the first conjunct is within the focus-domain. After F-closure, the result is just the same as (30). The sentence is ambiguous since the second conjunct can undergo QR, regardless of the scope possibility in the first conjunct.

(32) SOME BOY admires every teacher, and some GIRL does, too.

(Ambiguous)

$[[32]]^f = \exists x. x \text{ admires every teacher, and } \exists y \text{ [some } y \text{ admires every teacher].}$

- a.  $\exists x. x \text{ admires every teacher, and } \exists y \text{ [some}_i \text{ [every teacher}_j \text{ [} t_i \text{ } y \text{ admires } t_j]]]$  ( $\exists$  >  $\forall$ )
- b.  $\exists x. x \text{ admires every teacher, and } \exists y \text{ [every teacher}_j \text{ [some } y \text{ admires } t_j]]]$  ( $\forall$  >  $\exists$ )

When the quantifier is inside focus and existentially closed, it loses quantificational force. Thus,  $[[ \text{SOME BOY} ]]$ <sup>f</sup> is the same as  $[[ \text{MARY} ]]$ <sup>f</sup>. The final revision of the entailment account for Scope Parallelism is shown in (33):

- (33) Entailment account for Scope Parallelism (*Final*)
- The focus constituent in the antecedent and the elided part are existentially closed, i.e. F-closure (Schwarzschild 1999, Merchant 2001)
  - After QR, in case each conjunct contains multiple quantifiers, the conjuncts must mutually entail each other.
  - If in a conjunct QR does not result in a change of the truth conditions, each conjunct undergo QR independently.
  - When quantifier is focused, it loses quantificational force.

This account predicts that only surface scope is available when the whole subject of each conjunct is focused in (34). This is so because after F-closure *Mary* and *at least one boy* are both variables bound by existential quantifier. Therefore, there is no further scope-taking operation available, and only *at least one* $\forall$  is available. Thus, it falls under (33c).

- (34) MARY talked to every professor, and AT LEAST ONE BOY did too.  
 (at least one $\forall$ , \* $\forall$ >at least one)  
 $[[34]]^f = \exists x. x$  talked to every professor, and  $\exists y. y$  talked to every professor.

In (35), the second conjunct cannot take inverse scope since it would violate Scope Economy. The examples above indicate that the domain of focus-marking is a crucial factor for inverse scope under the entailment analysis.

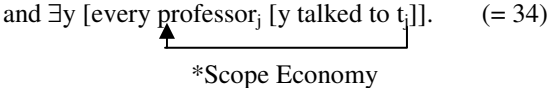
- (35) \* $\exists x. x$  talked to every professor,  
 and  $\exists y$  [every professor<sub>j</sub> [y talked to t<sub>j</sub>]]. (= 34)  

An interesting consequence the entailment account can predict is that a sentence like (36) with narrow-focus on *boy* in the first conjunct should be scopally ambiguous. The prediction appears to be borne out in (36-39). In (36-39), the entailment analysis can capture the puzzles that the previous approaches raise (Asher, Hardt, & Busquets 2001, Asudeh & Crouch 2002, Jacobson 1998, Johnson and Lappin 1997, 1999).

- (36) At least one BOY admires every teacher and MARY does, too  
 (At least one $\forall$ ,  $\forall$ >at least one)

$[[36]]^f = \exists x$  [at least one  $x$  admires every teacher], and  $\exists y$ .  $y$  admires every teacher.

a.  $\exists x$  [every professor <sub>$i$</sub>  [at least one  $x$  admires  $t_i$ ]], and  $\exists y$ .  $y$  admires every teacher. ( $\forall >$  at least one)

b.  $\exists x$  [at least one <sub>$j$</sub>  [every professor <sub>$i$</sub>  [ $t_j$   $x$  admires  $t_i$ ]], and  $\exists y$ .  $y$  admires every teacher. (at least one  $>$   $\forall$ )

(37=22) Every STUDENT read a book and HARRY did, too. (Ambiguous)

(38=23) Several WAITERS knew every customer. CHEF PIERRE did, too. (Ambiguous)

(39=24) At least one LABOUR MP attended most committee meetings, and BILL did, too. (Ambiguous)

The entailment account can also explain Scope Parallelism in non-ellipsis context in (40): (40a-b) mutually entail each other, but not (40c-d).

(40=13) JOHN gave every student a TEST, and BILL gave every student a PROJECT

$[[40]]^f = \exists x. \exists y$ .  $x$  gave every student a  $y$ , and  $\exists x$ .  $\exists y$ .  $x$  gave every student a  $y$ .

a.  $\exists > \forall \leftrightarrow \exists > \forall$

b.  $\forall > \exists \leftrightarrow \forall > \exists$

\*c.  $\exists > \forall \rightarrow \forall > \exists$ , \* $\exists > \forall \leftarrow \forall > \exists$

\*d. \* $\forall > \exists \rightarrow \exists > \forall$ ,  $\forall > \exists \leftarrow \exists > \forall$

## 5 Conclusion

In this paper, I argue that *Scope Parallelism* can be captured by mutual entailment relationship between LF structures of the conjuncts, instead of Fox's (2000) Direct and Indirect Parallelism constraints. With this, we can have a more principled explanation for the parallel scope phenomenon.

The entailment analysis of Scope Parallelism is compatible with semantic identity (e.g. Merchant 2001), rather than syntactic isomorphism. However, in this paper, the entailment relationship is relevant after QR.

The entailment analysis can account for the counterexamples to Fox's analysis in (36-39). That is, if the first conjunct contains multiple quantifiers and the second conjunct is scopally rigid after focus-closure, the sentence is ambiguous.



## References

- Asher, Nicholas, Daniel Hardt, and Joan Busquets. 2001. "Discourse Parallelism, Scope, and Ellipsis", *Journal of Semantics*, **18**. 1-25.
- Asudeh, Ash, and Richard Crouch. 2002. Derivational Parallelism and Ellipsis Parallelism. *Proceedings of West Coast Conference on Formal Linguistics 21*, ed. L. Mikkelsen, C. Potts, pp. 1-15. Somerville, MA: Cascadilla Press.
- Hirschbühler, Paul. 1982. "VP-Deletion and Across-the Board Quantifier Scope", *Proceedings of North East Linguistic Society*, **12**. 132-139.
- Fox, Danny. 1995. "Economy and scope", *Natural Language Semantics*, **3**. 283-341.
- \_\_\_\_\_. 2000 *Economy and semantic interpretation*. Cambridge, MA: MIT Press.
- Jacobson, Pauline, 1998. Where (if anywhere) is transderivationality located? In Louise McNally and Peter W. Culicover, editors, *The Limits of Syntax*, pp. 303–366. San Diego, CA: Academic Press.
- Johnson, David and Shalom Lappin, 1997. "A critique of the Minimalist Program", *Linguistics and Philosophy*, **20**. 273–333.
- Johnson, David and Shalom Lappin, 1999. *Local Constraints Vs. Economy*. Stanford, CA: CSLI Publications.
- Merchant, Jason. 2001. *The syntax of silence*. Oxford, UK: Oxford University Press.
- Rooth, Mats. 1992. "A theory of focus interpretation", *Natural Language Semantics*, **1**. 75-116.
- Tancredi, Chris. 1992. *Deletion, deaccenting, and presupposition*. Doctoral dissertation, MIT, Cambridge, MA.
- Sag, Ivan. 1976. *Deletion and Logical Form*. Doctoral dissertation, MIT, Cambridge, MA.
- Williams, Edwin. 1977. "Discourse and Logical Form", *Linguistic Inquiry*, **8**. 101-139.

Seungwan Ha  
Boston University  
seungwan@bu.edu

# Extremely Local Optimization

Fabian Heck & Gereon Müller  
Universität Leipzig

## 1. Introduction

This article pursues the idea that properties of the Minimalist Program (MP, Chomsky 1995, Chomsky 2001) and Optimality Theory (OT, Prince & Smolensky 2004, McCarthy & Prince 2004) can be fruitfully combined. We concentrate on two properties. First, MP's tenet that syntactic structure is built up by repeated application of Merge, Move, and Agree.<sup>1</sup> Second, OT's assumption that the well-formedness of a syntactic object involves comparison with other objects, hence optimization.

Standardly, Merge, Move, etc. are assumed to apply first, thereby creating a set of candidates that is then subject to optimization. Optimization is *global* in the sense that it applies once to complete structures (see Grimshaw 1997, Pesetsky 1998, Legendre, Smolensky & Wilson 1998, among others). Alternatively, structure building operations and optimization apply in a cyclic interleaving fashion: Merge, Move, etc. create output candidates  $\alpha_1 \dots, \alpha_n$ , which are subject to optimization. The optimal  $\alpha_i$  serves as (part of) the input for the next cycle and so on, until the numeration is empty. Optimization is *local* in the sense that it applies iteratively to small portions of structure (see Ackema & Neeleman 1998, Müller 2000c, Heck & Müller 2000, Fanselow & Ćavar 2001, among others). This raises the natural question as to how large optimization domains are. Optimization has been suggested to apply to clauses (Ackema & Neeleman 1998), phases (Fanselow & Ćavar 2001, Müller 2000a), phrases (Müller 2000c, Heck & Müller 2000, Fischer 2004, Heck 2004), or after each step (Chomsky 2000, Epstein & Seely 2002). We pursue the consequences of the last, most radical position and refer to it as *extremely local optimization*.

We will provide empirical support for extremely local optimization, based on (a) argument encoding, (b) dative possessors, and (c) SpecC-expletives. The argument's structure is always the same: (i) Sometimes, the relative order of Agree and Merge is under-determined. Provided that they cannot apply simultaneously (see Epstein & Seely 2002; contra Pullum 1976, Chomsky 2005), this creates a conflict: Both are required to be executed immediately, but only one of them can. (ii) The conflict can be resolved

by ranking the requirements: The higher ranked requirement is satisfied immediately; the lower ranked must remain unsatisfied, momentarily. As unsatisfiability does not lead to a crash of the derivation, this suggests an analysis in terms of violable constraints. (iii) *Ceteris paribus*, larger optimization domains cannot preserve the order of operations induced by extremely local optimization. Empirically, this yields the wrong result.

## 2. Constraints, Features, and Operations

We assume that the derivation is driven by two types of features: (i) Structure-building features, which trigger Merge<sup>2</sup>. And (ii) probe features, which trigger Agree. We write them as [**•F•**] and [**\*F\***], respectively. Next, we assume that Move and Merge are dependent on the presence of [**•F•**]. This is ensured by the definitions in (1) and (2).

- (1) *Merge*:  $\alpha$  can be merged with  $\beta$ , yielding  $\{\alpha, \{\alpha, \beta\}\}$ , if  $\alpha$  bears a structure-building feature [**•F•**] and F is the label of  $\beta$ .
- (2) *Move*: Move is Merge, with  $\beta$  internal to  $\alpha$ .

Moreover, we adopt Chomsky's (2001) operation Agree in (3).<sup>3</sup>

- (3) *Agree*:  $\alpha$  can agree with  $\beta$  with respect to a feature bundle  $\Gamma$  iff (a) and (b) hold:
  - a.  $\alpha$  bears a probe feature [**\*F\***] in  $\Gamma$  and may thereby provide the  $\alpha$ -value for a matching goal feature [F] of  $\beta$  in  $\Gamma$ .
  - b.  $\alpha$  m-commands  $\beta$ .

We also assume that [**\*F\***] and [**•F•**] features are targeted once during the derivation by Merge or Agree respectively, see the constraints in (4), (5).

- (4) AGREE CONDITION (AC):  
Probes ([**\*F\***]) participate in Agree.
- (5) MERGE CONDITION (MC):  
Structure-building features ([**•F•**]) participate in Merge.

Finally, we presuppose that the derivation unfolds in a cyclic manner and that movement is feature-driven, see the constraints (6) and (7).<sup>4</sup>

- (6) STRICT CYCLE CONDITION (SCC, Chomsky (1973, 1993):  
Merge of  $\alpha$  and  $\beta$  is possible only if  $\beta$  has no active features. (A feature is active if it is a [**•F•**] or [**\*F\***] feature that has not yet participated in Merge or Agree).
- (7) LAST RESORT (LR, Chomsky 1995):  
Move of  $\alpha$  and  $\beta$  follows Agree of  $\alpha$  and  $\beta$ .

### 3. Empirical Evidence

#### 3.1. Argument encoding

##### 3.1.1. Data

To simplify matters, there are two basic patterns of argument encoding. In accusative languages, the internal argument ( $DP_{int}$ ) of a transitive verb ( $V_t$ ) bears accusative case. In contrast,  $DP_{int}$  of an intransitive verb ( $V_i$ ) and external arguments ( $DP_{ext}$ ) in general bear nominative case (see (8-a)). In ergative languages,  $DP_{ext}$  of a  $V_t$  bears ergative, whereas its internal co-argument and the only argument of a  $V_{int}$  bear absolutive case (see (8-b)).

(8) *Basic patterns of argument encoding:*

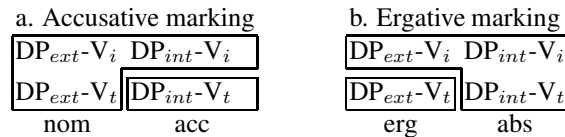

For lack of space, we dispense with giving examples from actual languages and rather leave it at presenting the abstract patterns in (8).

##### 3.1.2. Analysis

Our analysis requires the following assumptions. (i) There is one structural argument encoding feature: [case]. (ii) [case] can have two values: ext(ernal) and int(ernal). (iii) The valued feature [case:ext] expresses nominative/absolutive case, the valued feature [case:int] expresses accusative/ergative case (see Murasugi 1992). (iv) [case] features figure in Agree relations involving T/v on the one hand and DP on the other hand, as in (9).

(9) *The role of T and v in argument encoding:*

- a. T bears [ $*\text{case:ext}*$ ] that instantiates [case:ext] on DP.
- b. v bears [ $*\text{case:int}*$ ] that instantiates [case:int] on DP.

Observe that v has a dual role: It participates in a Merge operation with  $DP_{ext}$ ; but it also participates in an Agree relation. This dual role has far-reaching consequences for the nature of argument encoding.

To see why, consider a simple transitive context, with two arguments  $DP_{int}$ ,  $DP_{ext}$ . Suppose that the derivation has reached a stage  $\Sigma$ , where v has been merged with a VP containing  $DP_{int}$ , with  $DP_{ext}$  waiting to be merged with v in the workspace of the derivation. Due to the dual role of v, a conflict arises at this point: AC demands that the next operation is Agree(v,  $DP_{int}$ ), MC demands that it is Merge( $DP_{ext}$ , v). Note that if constraints are evaluated after each derivational step, then this derives the

effects of Pesetsky's (1989) Earliness Principle, see Chomsky (2001, 15). Evaluation at each step, in turn, will follow from the idea that constraint evaluation, hence optimization, is extremely local (see below).

Before we address the issue how the conflict is resolved, note that Agree is assumed to be subject to the MINIMAL LINK CONDITION, see (10).

- (10) MINIMAL LINK CONDITION (MLC, Chomsky 1995, 2001):  
An Agree operation involving  $\alpha$  and  $\beta$  can only take place if there is no  $\delta$  such that (i) and (ii) hold:
- a.  $\delta$  is closer to  $\alpha$  than  $\beta$ .
  - b.  $\delta$  bears a feature that has not yet participated in Agree.
- (11) *Closeness*:  $\delta$  is closer to  $\alpha$  than  $\beta$  if the path from  $\delta$  to  $\alpha$  is shorter than the path from  $\beta$  to  $\alpha$ .
- (12) *Path* (Müller 1998, 130; cf. Pesetsky 1982, 289, Collins 1994, 56):  
The path from X to Y is the set of categories Z such that (a) and (b) hold:
- a. Z is reflexively dominated by the minimal XP that dominates both X and Y.
  - b. Z dominates X or Y.

The length of a path is determined by its cardinality.

The consequences of the MLC in (10), based on (11) and (12), are the following: (i) The specifier and the complement of a head qualify as equally close to the head. (ii) The specifier of a head is closer to the head than a category that is further embedded in the complement of the head. Applied to the derivational stage  $\Sigma$  above, it follows that once  $DP_{ext}$  indeed has undergone Merge with  $v$  in  $\Sigma$ , then  $DP_{ext}$  counts as closer to  $v$  than  $DP_{int}$ .

Returning to the main plot, we propose that the conflict is resolved by (language specific) ranking of the conflicting requirements AC and MC. The two possibilities of relative ranking yield the accusative and the ergative pattern of argument encoding. The relevant rankings are given in (13):

- (13) a. (MLC  $\gg$ ) AC  $\gg$  MC (Accusative pattern)  
b. (MLC  $\gg$ ) MC  $\gg$  AC (Ergative pattern)

Let us trace the relevant stages of the derivation, starting with the accusative pattern. We enter the derivation at stage  $\Sigma$ . Since AC  $\gg$  MC, Agree takes priority over Merge. Agree targets the probe [*\*case:int\**] of  $v$  and thus instantiates [*case:int*] on  $DP_{int}$ , see  $O_2$  in tableau  $T_1$ .<sup>5</sup>  $O_2$  from  $T_1$  serves as the input for the next cycle. AC being satisfied, MC can now be fulfilled by applying Merge to  $DP_{ext}$ . This targets the [**•D•**]-feature on  $v$ , resulting in the optimal output  $O_1$  in  $T_2$ . Again,  $O_1$  will serve as input for the next derivational cycle.

$T_1$ : *Accusative pattern, step 1* ( $\Sigma$  as input): *Agree*

|                                                                                                            |     |    |    |
|------------------------------------------------------------------------------------------------------------|-----|----|----|
| Input: [ $v'$ $v$ <sub>[*case:int*],[•D•]</sub> ... DP <sub>[case:□]</sub> ... ]                           |     |    |    |
| Workspace = { DP <sub>[case:□]</sub> , T <sub>[*case:ext*]</sub> , ... }                                   | MLC | AC | MC |
| $O_1$ : [ $v'$ DP <sub>[case:□]</sub> [ $v'$ $v$ <sub>[*case:int*]</sub> ... DP <sub>[case:□]</sub> ... ]] |     | *! |    |
| $O_2$ : [ $v'$ $v$ <sub>[•D•]</sub> ... DP <sub>[case:int]</sub> ... ]                                     |     |    | *  |

$T_2$ : *Accusative pattern, step 2: Merge*

|                                                                                       |     |    |    |
|---------------------------------------------------------------------------------------|-----|----|----|
| Input: [ $v'$ $v$ <sub>[•D•]</sub> ... DP <sub>[case:int]</sub> ... ]                 |     |    |    |
| Workspace = { DP <sub>[case:□]</sub> , T <sub>[*case:ext*]</sub> , ... }              | MLC | AC | MC |
| $O_1$ : [ $v_P$ DP <sub>[case:□]</sub> [ $v'$ $v$ ... DP <sub>[case:int]</sub> ... ]] |     |    |    |

We skip step 3, which merges the T-head (bearing [ $*case:ext*$ ]) with  $O_1$  of  $T_2$ . Once T is merged, AC demands T's [ $*case:ext*$ ] to establish Agree, which instantiates [ $case:ext$ ] on DP<sub>ext</sub>. The result is the accusative pattern.

$T_3$ : *Accusative pattern, step 4: Agree*

|                                                                                                            |     |    |    |
|------------------------------------------------------------------------------------------------------------|-----|----|----|
| Input: [ $T'$ T <sub>[*case:ext*]</sub> [ $v_P$ DP <sub>[case:□]</sub> ... DP <sub>[case:int]</sub> ... ]] |     |    |    |
| Workspace = { }                                                                                            | MLC | AC | MC |
| $O_1$ : [ $TP$ T [ $v_P$ DP <sub>[case:ext]</sub> [ $v'$ $v$ ... DP <sub>[case:int]</sub> ... ]]           |     |    |    |

Now reenter the derivation at stage  $\Sigma$  with the ranking  $MC \gg AC$ . MC immediately forces Merge of DP<sub>ext</sub>, consuming  $v$ 's [ $\bullet D \bullet$ ] feature at the cost of violating AC ( $v$ 's [ $*case:int*$ ] probe is still present), see  $O_1$  in  $T_4$ . At the next step,  $v$ 's [ $*case:int*$ ] probe can and must undergo Agree. Crucially, as DP<sub>ext</sub> is present it counts as closer to  $v$  than DP<sub>int</sub>. Therefore,  $v$ 's probe instantiates [ $case:int$ ] on DP<sub>ext</sub> (see  $O_1$  in  $T_5$ ). Valuation of DP<sub>int</sub>'s goal fatally violates the MLC (see  $O_2$ ). Once T with its [ $*case:ext*$ ] probe has been merged, it instantiates [ $case:ext$ ] on DP<sub>int</sub>. This derives the ergative pattern. Although we have not depicted these last two competitions, note in passing that Agree(T, DP<sub>int</sub>) is just local enough to be in accordance with the PIC in Chomsky (2001, 14). DP<sub>ext</sub> does not intervene between T and DP<sub>int</sub> because DP<sub>ext</sub>'s case feature has already participated in Agree.

$T_4$ : *Ergative pattern, step 1* ( $\Sigma$  as input): *Merge*

|                                                                                                            |     |    |    |
|------------------------------------------------------------------------------------------------------------|-----|----|----|
| Input: [ $v'$ $v$ <sub>[*case:int*],[•D•]</sub> ... DP <sub>[case:□]</sub> ... ]                           |     |    |    |
| Workspace = { DP <sub>[case:□]</sub> , T <sub>[*case:ext*]</sub> , ... }                                   | MLC | MC | AC |
| $O_1$ : [ $v'$ DP <sub>[case:□]</sub> [ $v'$ $v$ <sub>[*case:int*]</sub> ... DP <sub>[case:□]</sub> ... ]] |     |    | *  |
| $O_2$ : [ $v'$ $v$ <sub>[•D•]</sub> ... DP <sub>[case:int]</sub> ... ]                                     |     | *! |    |

$T_5$ : Ergative pattern, step 2: Agree (with  $DP_{ext}$ )

|                                                                                                |     |    |    |
|------------------------------------------------------------------------------------------------|-----|----|----|
| Input: $[_{v'} DP_{[case:\square]} [_{v'} V_{[*case:int*]} \dots DP_{[case:\square]} \dots ]]$ |     |    |    |
| Workspace = $\{T_{[*case:ext*]}, \dots\}$                                                      | MLC | MC | AC |
| $\star O_1$ : $[_{vP} DP_{[case:int]} [_{v'} v \dots DP_{[case:\square]} \dots ]]$             |     |    |    |
| $O_2$ : $[_{vP} DP_{[case:\square]} [_{v'} v \dots DP_{[case:int]} \dots ]]$                   | *!  |    |    |

### 3.1.3. Less local optimization

Suppose that optimization targets complete phrases. Then it will not apply unless  $v$  has been Merged with  $DP_{ext}$ , forming a complete  $vP$ . The ergative pattern is straightforwardly derived under the ranking  $MC \gg AC$ , as before. We skip the relevant competition. Of more interest is the attempt to derive the accusative pattern under the ranking  $AC \gg MC$ : In a fully-fledged  $vP$   $DP_{ext}$  is always closer to  $[*case:int*]$  on  $v$ . But then, given the MLC,  $[*case:int*]$  cannot be instantiated on  $DP_{int}$ , but must be instantiated on  $DP_{ext}$ . This yields again the ergative but not the accusative pattern (see  $O_1$  in  $T_6$ ). Thus less local optimization undergenerates. The argument is independent of MLC's ranking relative to AC or MC.

$T_6$ :  $vP$  optimization under  $AC \gg MC$  ('accusative') ranking: wrong result

|                                                                                                                     |     |    |    |
|---------------------------------------------------------------------------------------------------------------------|-----|----|----|
| Input: $DP_{[case:\square]}, V_{[*case:int*],[\bullet D\bullet]}, \dots, [_{vP} \dots DP_{[case:\square]} \dots ]]$ |     |    |    |
| Workspace = $\{T_{[*case:ext*]}, \dots\}$                                                                           | MLC | AC | MC |
| $\star O_1$ : $[_{vP} DP_{[case:int]} [_{v'} v \dots DP_{[case:\square]} \dots ]]$                                  |     |    |    |
| $O_2$ : $[_{vP} DP_{[case:\square]} [_{v'} v \dots DP_{[case:int]} \dots ]]$                                        | *!  |    |    |

## 3.2. Prenominal dative possessors in German

### 3.2.1. Data

German DPs can contain a dative-marked possessor ( $DP_{dat}$ ) in SpecD (see Haider 1988, Zifonun 2004). The head of such DPs is realized by a possessive pronoun, which exhibits a twofold agreement pattern. (i) The root of the pronoun agrees with  $DP_{dat}$  with respect to [num] and [gen]. (ii) The inflection of the pronoun agrees with its complement NP with respect to [num], [gen], and [case]. We focus here on agreement with respect to [gen] (see (14)), but everything can be transferred to the other features as well.

(14) Gender agreement with dative possessors in German:

- a.  $[_{DP} \text{dem Fritz}] \text{ sein } -e \text{ Schwester}$   
the.masc Fritz his.masc -fem sister.fem  
‘Fritz’s sister’
- b.  $*[_{DP} \text{dem Fritz}] \text{ ihr } -\emptyset \text{ Schwester}$   
the.masc Fritz her.fem -masc sister.fem

## 3.2.2. Analysis

Suppose the following. (i)  $DP_{dat}$  is merged as a complement of the possessee (de Vries 2005) and undergoes [ $\bullet$ EPP $\bullet$ ]-driven movement to SpecD. (ii) Functional elements as pronouns are realized by post-syntactic morphology (see, e.g., Halle & Marantz 1993). (iii) The pronoun's inflectional features occupy a structurally higher position than its root ( $\sqrt{\quad}$ ) features.<sup>6</sup>

It follows that the pronoun has a dual role: It bears [ $*gen:\square*$ ] probes that trigger Agree and an [ $\bullet$ EPP $\bullet$ ]-feature that triggers (internal) Merge. This causes a conflict. Suppose the derivation has reached stage  $\Sigma$ , where the pronoun has been merged. Then AC demands Agree(D, $DP_{dat}$ ) or Agree(D, NP); and MC demands  $DP_{dat}$  raising to SpecD. The conflict can be resolved by ranking AC over MC, yielding the correct agreement pattern.

(15) MLC  $\gg$  AC  $\gg$  MC  $\gg$  LR (Ranking for German)

Suppose we want to derive (14-a). We enter the derivation at stage  $\Sigma$ . Due to AC  $\gg$  MC, Agree must apply first. Since the pronoun's inflectional probes are structurally higher than its root probes, the former count as closer to both NP and  $DP_{dat}$ . Thus the MLC constrains Agree to the inflectional probes. Moreover, the NP counts as closer to the pronoun than  $DP_{dat}$ . Thus Agree(NP,infl) instantiates [ $gen_{infl}:fem$ ] on the pronoun (see  $O_1$  in  $T_7$ ). Having undergone Agree, the NP and the inflection are inactive. Hence, Agree can next affect the pronoun's root probes and  $DP_{dat}$ . This values [ $gen_{\sqrt{\quad}}:masc$ ] on the pronoun (see  $O_1$  in  $T_8$ ). Finally, MC can be satisfied by movement of the possessor DP to SpecD (this optimization is skipped).

$T_7$ : Evaluation of gender inflection: Agree

|                                                                                                                                                                                       |     |    |    |    |
|---------------------------------------------------------------------------------------------------------------------------------------------------------------------------------------|-----|----|----|----|
| Input: [ $DP_1$ D $_{[*case:dat*],[*gen_{\sqrt{\quad}}:\square*],[*gen_{infl}:\square*],[\bullet$ EPP $\bullet$ ]<br>[NP N $_{[gen:fem]}$ DP $_2$ $_{[case:\square],[gen:masc]}$ ] ]] | MLC | AC | MC | LR |
| $O_1$ : [ $DP_1$ D $_{[*case:dat*],[*gen_{\sqrt{\quad}}:\square*],[gen_{infl}:fem],[\bullet$ EPP $\bullet$ ]<br>[NP N $_{[gen:fem]}$ DP $_2$ $_{[case:\square],[gen:masc]}$ ] ]]      |     | ** | *  |    |
| $O_2$ : [ $DP_1$ D $_{[*case:dat*],[gen_{\sqrt{\quad}}:fem],[*gen_{infl}:\square*],[\bullet$ EPP $\bullet$ ]<br>[NP N $_{[gen:fem]}$ DP $_2$ $_{[case:\square],[gen:masc]}$ ] ]]      | *!  | ** | *  |    |

$T_8$ : Evaluation of root's gender and possessor's case: Agree

|                                                                                                                                                                                 |     |     |    |    |
|---------------------------------------------------------------------------------------------------------------------------------------------------------------------------------|-----|-----|----|----|
| Input: [ $DP_1$ D $_{[*case:dat*],[*gen_{\sqrt{\quad}}:\square*],[gen_{infl}:fem],[\bullet$ EPP $\bullet$ ]<br>[NP N $_{[gen:fem]}$ DP $_2$ $_{[case:\square],[gen:masc]}$ ] ]] | MLC | AC  | MC | LR |
| $O_1$ : [ $DP_1$ D $_{[case:dat],[gen_{\sqrt{\quad}}:masc],[gen_{infl}:fem],[\bullet$ EPP $\bullet$ ]<br>[NP N $_{[gen:fem]}$ DP $_2$ $_{[case:dat],[gen:masc]}$ ] ]]           |     |     | *  |    |
| $O_2$ : [ $DP_1$ DP $_2$ $_{[case:\square],[gen:masc]}$<br>D $_{[*case:dat*],[gen_{infl}:fem],\dots}$ [NP N $_{[gen:fem]}$ t $_2$ ] ]]                                          |     | *!* |    | *  |



### 3.2.3. Less local optimization

Suppose optimization applied to phrases. An optimal DP will always involve raising of DP<sub>dat</sub>. But with DP<sub>dat</sub> raised, both DP<sub>dat</sub> and NP are equally close to the pronoun. Then the inflectional probe can receive value [masc], deriving (14-b) (see O<sub>2</sub> in T<sub>9</sub>): Thus the approach overgenerates.

T<sub>9</sub>: Phrasal optimization: wrong result

| Input: D <sub>[*case:dat*],[*gen<sub>√</sub>:□*],[*gen<sub>infl</sub>:□*],[•EPP•],... +<br/>[NP N<sub>[gen:fem] DP<sub>2</sub>[case:□],[gen:masc]]</sub></sub>                        | MLC | AC | MCL | LR |
|---------------------------------------------------------------------------------------------------------------------------------------------------------------------------------------|-----|----|-----|----|
| O <sub>1</sub> : [DP <sub>1</sub> DP <sub>2</sub> [case:dat],[gen:masc]<br>D <sub>[case:dat],[gen<sub>√</sub>:masc],... [NP N<sub>[gen:fem] t<sub>2</sub> ]]</sub></sub>              |     |    |     |    |
| ★O <sub>2</sub> : [DP <sub>1</sub> DP <sub>2</sub> [case:dat],[gen:masc]<br>D <sub>[case:dat],[gen<sub>infl</sub>:masc],... [NP N<sub>[gen:fem] t<sub>2</sub> ]]</sub></sub>          |     |    |     |    |
| O <sub>3</sub> : [DP <sub>1</sub> D <sub>[case:dat],[gen<sub>√</sub>:masc][gen<sub>infl</sub>:fem],[•EPP•]</sub><br>[NP N <sub>[gen:fem] DP<sub>2</sub>[case:dat],[gen:masc] ]]</sub> |     |    | *!  |    |
| O <sub>4</sub> : [DP <sub>1</sub> DP <sub>2</sub> [case:dat],[gen:masc]<br>D <sub>[case:dat],[*gen<sub>√</sub>:□*],... [NP N<sub>[gen:fem] t<sub>2</sub> ]]</sub></sub>               |     | *! |     |    |

## 3.3. SpecC-expletives in German

### 3.3.1. Data

SpecC-expletive insertion in V/2 clauses in German looks like a repair phenomenon: The expletive *es* can only be inserted if no other element fills SpecC (see (16)) and if it is necessary at all to fill this position (see (17)).

(16) *Expletives in V/2 clauses in German* ('Vorfeld-*es*):

- a. Es haben viele Leute geschlafen  
EXPL have many people<sub>nom</sub> slept
- b. Viele Leute haben geschlafen  
many people<sub>nom</sub> have slept

(17) *Blocked expletives in verb-final clauses in German:*

- a. dass viele Leute geschlafen haben  
that many people<sub>nom</sub> slept have
- b. \*es dass viele Leute geschlafen haben  
EXPL that many people<sub>nom</sub> slept have

*Es*-insertion is optional. In Müller's (2000*b*, 48-49) analysis, this is traced back to a tie of the two crucial constraints (ECONOMY and FULL-INTERPRETATION are tied, and ranked below SPECV/2 ('The specifier of V/2 must be filled.').) Next, Bierwisch (1961, 111) observes that expletive insertion is incompatible with nominative pronouns (see also Erdmann 1886, §94): Another element moves to fill SpecC (see (18-a) vs. (18-b)).

(18) *Expletive/subject pronoun incompatibility:*

- a. \*Es    habe    ich        geraucht  
       EXPL have<sub>1.sg</sub> I<sub>1.sg.nom</sub> smoked
- b. Ich        habe    t geraucht  
       I<sub>1.sg.nom</sub> have<sub>1.sg</sub> smoked

### 3.3.2. Analysis

To begin with, if expletives never show up in numerations (Hornstein 2001), then their insertion will violate the constraint in (19).

- (19) INCLUSIVENESS CONDITION (IC, Chomsky 2001):  
 Only material from the numeration can be used in a derivation.

Suppose now that AC and MC are actually relativized to phase domains. Thus there exist  $AC_v$ ,  $AC_D$ ,  $AC_C$ ,  $MC_v$ ,  $MC_D$ , and  $MC_C$ .<sup>7</sup> We assume here that  $MC_C \circ AC_C$  (in contrast to the rankings  $AC_v \gg MC_v$  and  $AC_D \gg MC_D$  motivated above), where  $\circ$  denotes a global constraint tie. The complete relevant ranking is shown in (20).

- (20)  $MLC \gg AC_C \circ MC_C \gg LR \gg IC$

Also, we follow Platzack (1987) (Holmberg & Platzack 1995; Chomsky 2005), assuming that C bears  $[\Phi]/[\text{case}]$  relevant for subject agreement and nominative assignment (not T; cf. also Haider 1993).

It follows that a V/2 C has a dual role: It has an  $[\bullet\text{EPP}\bullet]$  feature that triggers Merge, and  $[\Phi/\text{case}]$  features that trigger Agree. Consider a context with a V/2 C. Suppose that the derivation has reached a stage  $\Sigma$  where C has been merged with a TP containing  $DP_{ext}$ , with nothing waiting to be merged with C in the workspace. Then  $AC_C$  demands application of  $\text{Agree}(C, DP_{ext})$ , and  $MC_C$  demands insertion of an expletive pronoun in  $\text{Spec}(\text{Merge}(DP_{expl}, C))$ : a conflict.<sup>8</sup> The conflict is resolved by ranking  $AC_C$  and  $MC_C$ , yielding expletive insertion and movement of  $DP_{ext}$  in *one* language (because of the tie), in interaction with IC, LR, and MLC.

Suppose we enter the derivation at stage  $\Sigma$ . If  $AC_C \gg MC_C$ , then the probes of C enter into an Agree relation with  $DP_{ext}$ , thereby instantiating  $[\Phi]$  and  $[\text{case}]$  on C (see  $O_2$  in  $T_{10}$ ). Expletive insertion is blocked. The second step involves movement of  $DP_{ext}$  to  $\text{Spec}C$ , satisfying  $MC_C$ . Note that expletive insertion is blocked at this point by IC (see  $O_2$  vs.  $O_1$  in  $T_{11}$ ).

If  $MC_C \gg AC_C$ , Merge applies first. As  $LR \gg IC$ , expletive insertion is favored over movement of  $DP_{ext}$  (see  $O_1$  vs.  $O_3$  in  $T_{12}$ ). Once the expletive occupies  $\text{Spec}C$ , it counts as closer to the probes on C than  $DP_{ext}$ . Thus, the expletive values  $[\text{pers}:3]$  on the C-head (see  $O_1$  in  $T_{13}$ ).  $\text{Agree}(C, DP_{ext})$  is blocked by the MLC (see  $O_2$ ). Crucially, C can never check  $DP_{ext}$ 's  $[\text{pers}]$  feature. If features that are required for post-syntactic spell-out must

be checked in syntax, this derives the incompatibility of expletive *es* and subject pronouns (see (18)): A subject pronoun cannot be spelled out in the context of an expletive because its [pers] feature has not been checked.<sup>9</sup> In the last step C's remaining probes establish Agree with DP<sub>ext</sub>. The [pers] probe on the expletive is no obstacle, having participated in Agree at the preceding step. For reasons of space this competition is not illustrated here.

$T_{10}$ : Subject movement, step 1 ( $\Sigma$  as input): Agree

| Input: [C' C <sub>[*case:ext*],[*pers:□*],...,[●EPP●]</sub><br>... DP <sub>[case:□],[pers:x],... .. ]</sub>                                            | MLC | AC | MC | LR | IC |
|--------------------------------------------------------------------------------------------------------------------------------------------------------|-----|----|----|----|----|
| O <sub>1</sub> : [C' DP <sub>[pers:3]</sub> [C' C <sub>[*case:ext*],[*pers:□*],...<br/>... DP<sub>[case:□],[pers:x],[num:y],[gen:z] ... ]]</sub></sub> |     | *! |    |    | *  |
| $\mathbb{E}$ O <sub>2</sub> : [C' C <sub>[pers:x],...,[●EPP●]</sub><br>... DP <sub>[case:ext],[pers:x],... .. ]</sub>                                  |     |    | *  |    |    |
| O <sub>3</sub> : [C' DP <sub>[case:□],[pers:□],...<br/>[C' C<sub>[pers:x],... .. t<sub>DP</sub> ... ]</sub></sub>                                      |     | *! |    |    | *  |

$T_{11}$ : Subject movement, step 2: Move

| Input: [C' C <sub>[pers:x],...,[●EPP●]</sub><br>... DP <sub>[case:ext],[pers:x],... .. ]</sub>                                   | MLC | AC | MC | LR | IC |
|----------------------------------------------------------------------------------------------------------------------------------|-----|----|----|----|----|
| O <sub>1</sub> : [CP DP <sub>[pers:3]</sub> [C' C <sub>[pers:x],...<br/>... DP<sub>[case:ext],[pers:x],... .. ]]</sub></sub>     |     |    |    |    | *! |
| $\mathbb{E}$ O <sub>2</sub> : [CP DP <sub>[case:ext],[pers:x],...<br/>[C' C<sub>[pers:x],... .. t<sub>DP</sub> ... ]</sub></sub> |     |    |    |    |    |

$T_{12}$ : Expletive insertion, step 1 ( $\Sigma$  as input): Merge

| Input: [C' C <sub>[*case:ext*],[*pers:□*],...,[●EPP●]</sub><br>... DP <sub>[case:□],[pers:x],... .. ]</sub>                                            | MLC | MC | AC | LR | IC |
|--------------------------------------------------------------------------------------------------------------------------------------------------------|-----|----|----|----|----|
| $\mathbb{E}$ O <sub>1</sub> : [C' DP <sub>[pers:3]</sub> [C' C <sub>[*case:ext*],[*pers:□*],...<br/>... DP<sub>[case:□],[pers:x],... .. ]]</sub></sub> |     |    | *  |    | *  |
| O <sub>2</sub> : [C' C <sub>[pers:x],...,[●EPP●]</sub><br>... DP <sub>[case:ext],[pers:x],... .. ]</sub>                                               |     |    | *! |    |    |
| O <sub>3</sub> : [C' DP <sub>[case:□],[pers:□],... [C' C<sub>[pers:x],...<br/>... t<sub>DP</sub> ... ]</sub></sub>                                     |     |    | *  | *! |    |

### 3.3.3. Less local optimization

Suppose that optimization affects the phrase. Note that a CP-candidate can perfectly satisfy AC, MC, MLC, and LR. Consequently, IC will be decisive, and will always block expletive insertion, irrespective of the ranking. Expletive insertion can be advantageous only at a certain specific stage in

$T_{13}$ : Expletive insertion, step 2: (Partial) Agree with expletive

|                                                                                                                                             |     |    |    |    |    |
|---------------------------------------------------------------------------------------------------------------------------------------------|-----|----|----|----|----|
| Input: $O_1$ : [ $C'$ DP <sub>[pers:3]</sub> [ $C'$ C <sub>[*case:ext*],[*pers:□*],...</sub> ... DP <sub>[case:□],[pers:x],... ... ]]</sub> | MLC | MC | AC | LR | IC |
| $O_1$ : [ $C'$ DP <sub>[pers:3]</sub> [ $C'$ C <sub>[*case:ext*],[pers:3],...</sub> ... DP <sub>[case:□],[pers:x],... ... ]]</sub>          |     |    | *  |    |    |
| $O_2$ : [ $CP$ DP <sub>[pers:3]</sub> [ $C'$ C <sub>[pers:x],...</sub> ... DP <sub>[case:ext],[pers:x],... ... ]]</sub>                     | *!  |    |    |    |    |

the derivation (where moving DP<sub>ext</sub> is blocked by LR); after that stage, the advantage is gone. Thus, less local optimization undergenerates, see  $T_{14}$ .

$T_{14}$ : CP optimization under  $MC \gg AC$  (expletive) ranking: wrong result

|                                                                                                                                    |     |    |    |    |    |
|------------------------------------------------------------------------------------------------------------------------------------|-----|----|----|----|----|
| Input: C <sub>[*case:ext*],[*pers:□*],...,[•EPP•]</sub><br>[TP ... DP <sub>[case:□],[pers:x],... ... ]]</sub>                      | MLC | MC | AC | LR | IC |
| $O_1$ : [ $CP$ DP <sub>[pers:3]</sub> [ $C'$ C <sub>[pers:x],...</sub> ... DP <sub>[case:ext],[pers:x],... ... ]]</sub>            |     |    |    |    | *! |
| $\star O_2$ : [ $CP$ DP <sub>[case:ext],[pers:x],[num:y],[gen:z]</sub> [ $C'$ C <sub>[pers:x],...</sub> ... t <sub>DP</sub> ... ]] |     |    |    |    |    |

## 4. Conclusion

In this article, we have suggested that optimization in syntax is extremely local: The optimization domain is not the phrase, the phase, the clause, or the sentence; it is the syntactic operation. Syntax operates by constantly alternating between single applications of syntactic operations producing derivational steps and choosing the optimal derivational step.

We provided three empirical arguments for extremely local optimization of the following shape. (i) The order of operations in MP is sometimes underdetermined. (ii) Resulting conflicts can be resolved by assuming constraint violability and constraint ranking. (iii) The evidence suggests that optimization is extremely local, affecting the single operation: Less local optimization loses distinctions that extremely local optimization can make.

## Notes

<sup>1</sup>But cf. Brody (1995), who takes a representational view.

<sup>2</sup>See Sternefeld (2006), Adger (2003).

<sup>3</sup>Unlike Chomsky, we permit an Agree relation between a head and its specifier.

<sup>4</sup>Move in (22) is a binary operation because Move is (binary) Merge with  $\beta$  internal to  $\alpha$ .

<sup>5</sup>We introduce the convention that an unvalued feature [F] is written as [F:□].)

<sup>6</sup>For instance, assume the following structure for the pronoun: [<sub>DP</sub> [<sub>D</sub>  $\sqrt{D}$ ] inflection ].

<sup>7</sup>We assume that, alongside vP and CP, DP constitutes a phase in the sense of Chomsky (2001).

<sup>8</sup>We focus on [case] and [pers] here; V/2 does not interact and is consequently ignored.

<sup>9</sup>A determiner, in contrast, can be spelled out because it does not bear a [pers] feature to begin with. Although pronouns are specified for [pers], other DPs are assumed not to be.

## References

- Ackema, Peter & Ad Neeleman. 1998. "Optimal Questions", *Natural Language and Linguistic Theory* **16**. 443-490.
- Adger, David. 2003. *Core Syntax*. Oxford, New York, Oxford University Press.
- Bierwisch, Manfred. 1961. "Syntactic Features in Morphology: General Problems of So-Called Pronominal Inflection in German". In: *To Honour Roman Jakobson*. The Hague/Paris, Mouton. 239-270.
- Brody, Michael. 1995. *Lexico-Logical Form: A Radically Minimalist Theory*. Cambridge, Mass., MIT Press.
- Chomsky, Noam. 1973. "Conditions on Transformations". In: *A Festschrift for Morris Halle*. New York, Academic Press. 232-286.
- Chomsky, Noam. 1993. "A Minimalist Program for Syntactic Theory". In: *The View from Building 20*. Cambridge, Mass., MIT Press. 1-52.
- Chomsky, Noam. 1995. *The Minimalist Program*. Cambridge, Mass., MIT Press.
- Chomsky, Noam. 2000. "Minimalist Inquiries: The Framework". In: *Step by Step*. Cambridge, Mass., MIT Press. 89-156.
- Chomsky, Noam. 2001. "Derivation by Phase", In: *Ken Hale. A Life in Language*. Cambridge, Mass., MIT Press, 1-52.
- Chomsky, Noam. 2005. "On Phases". Ms., MIT, Cambridge, Mass.
- Collins, Chris. 1994. "Economy of Derivation and the Generalized Proper Binding Condition", *Linguistic Inquiry* **25**. 45-61.
- de Vries, Mark. 2005. "Possessive Relatives and (Heavy) Pied Piping", *Journal of Comparative Germanic Linguistics* **9**, 1-52.
- Epstein, Sam & Daniel T. Seely. 2002. "Rule Applications as Cycles in a Level-Free Syntax". In: *Derivation and Explanation in the Minimalist Program*. Oxford, Blackwell. 65-89.
- Erdmann, Oskar. 1886. *Grundzüge der deutschen Syntax nach ihrer geschichtlichen Entwicklung*. Stuttgart, Cotta.
- Fanselow, Gisbert & Damir Ćavar. 2001. "Remarks on the Economy of Pronunciation". In: *Competition in Syntax*. Berlin, Mouton de Gruyter. 107-150.
- Grimshaw, Jane. 1997. "Projection, Heads, and Optimality", *Linguistic Inquiry* **28**. 373-422.
- Fischer, Silke. 2004. *Towards an Optimal Theory of Reflexivization*. PhD thesis, Universität Tübingen.
- Haider, Hubert. 1988. "Zur Struktur der deutschen Nominalphrase", *Zeitschrift für Sprachwissenschaft* **7**, 32-59.
- Haider, Hubert. 1993. *Deutsche Syntax – generativ*. Tübingen, Narr.
- Halle, Morris & Alec Marantz. 1993. "Distributed Morphology and the Pieces of Inflection". In: *The View from Building 20*. Cambridge, Mass., MIT Press, 111-176.
- Heck, Fabian. 2004. *A Theory of Pied Piping*. PhD thesis, Universität Tübingen.
- Heck, Fabian & Gereon Müller. 2000. "Repair-Driven Movement and the Local Optimization of Derivations". Ms., Universität Stuttgart and IDS Mannheim.

- Holmberg, Anders & Christer Platzack. 1995. *The Role of Inflection in the Syntax of the Scandinavian Languages*. Oxford, Oxford University Press.
- Hornstein, Norbert. 2001. *Move. A Minimalist Theory of Construal*. Oxford, Blackwell.
- Legendre, Géraldine, Paul Smolensky & Colin Wilson. 1998. "When is Less More? Faithfulness and Minimal Links in Wh-Chains". In: *Is the Best Good Enough?* Cambridge, Mass., MIT Press. 249-289.
- McCarthy, John & Alan Prince. 2004. "The Emergence of the Unmarked". In: *Optimality Theory in Phonology. A Reader*. Oxford, Blackwell . 483
- Müller, Gereon. 1998. *Incomplete Category Fronting*. Dordrecht, Kluwer.
- Müller, Gereon. 2000a. "Das Pronominaladverb als Reparaturphänomen", *Linguistische Berichte* **182**. 139-178.
- Müller, Gereon. 2000b. *Elemente der optimalitätstheoretischen Syntax*. Tübingen, Stauffenburg.
- Müller, Gereon. 2000c. "Shape Conservation and Remnant Movement". In: *Proceedings of NELS 30*. Amherst, Mass., GLSA, 525-539.
- Murasugi, Kumiko. 1992. *Crossing and Nested Paths*. PhD thesis, MIT, Cambridge, Mass.
- Pesetsky, David. 1982. *Paths and Categories*. PhD thesis, MIT, Cambridge, Mass.
- Pesetsky, David. 1989. "Language-Particular Processes and the Earliness Principle". Ms., MIT, Cambridge, Mass.
- Pesetsky, David. 1998. "Some Optimality Principles of Sentence Pronunciation". In: *Is the Best Good Enough?* Cambridge, Mass., MIT Press. 337-383.
- Platzack, Christer. 1987. "The Scandinavian Languages and the Null Subject Parameter", *Natural Language and Linguistic Theory* **5**. 377-402.
- Prince, Alan & Paul Smolensky. 2004. *Optimality Theory. Constraint Interaction in Generative Grammar*. Blackwell.
- Pullum, Geoffrey. 1976. "Sequential and Simultaneous Rule Application in Spanish Phonology", *Lingua* **38**. 221-262.
- Sternefeld, Wolfgang. 2006. *Syntax – Eine morphologisch motivierte generative Beschreibung des Deutschen*. Tübingen, Stauffenburg Verlag.
- Zifonun, Gisela. 2004. "Dem Vater sein Hut – Der Charme des Substandards und wie wir ihm gerecht werden", *Deutsche Sprache* **03**. 97-126.

# Verb Phrase Pronominalization in Danish: Deep or Surface Anaphora?\*

Michael J. Houser, Line Mikkelsen, and Maziar Toosarvandani  
University of California, Berkeley

## 1. Introduction

In their seminal (1976) paper Hankamer and Sag show that anaphora comes in two basic types. Deep anaphors, like the *it* in *Jasper ate a durian but Maria couldn't do it*, are syntactically atomic. They receive their interpretation from rules of semantic interpretation that make reference to objects in a discourse or other semantic model (Sag and Hankamer 1984). Surface anaphors on the other hand possess a fully articulated syntactic structure whose surface representation is rendered opaque by phonological operations such as deletion. Verb Phrase Ellipsis (VPE), for example, results from the nonpronunciation of a full-fledged verb phrase: *Rupert likes horse races but Holly doesn't [~~like horse races~~]*.

Crucially for Hankamer and Sag, whether an anaphor is deep or surface is independent of whether it has an overt phonological realization or not. For the most part, later research has backed up this claim. *Do it* anaphora (Kehler and Ward 2004) and Null Complement Anaphora (Depiante 2000) are instances of overt deep and nonovert deep anaphora respectively, while VPE and Sluicing are nonovert surface anaphors (Merchant 2001; Goldberg 2005). The exception is the overt surface category. Hankamer and Sag's only example is anaphoric *so*, e.g. *Adrian played chess and Roxanne did so too*, but this classification has since been called into question (Kehler and Ward 1999, 2004).

In this paper, we present data from a little-studied type of verb phrase anaphora in Danish and argue that it instantiates the controversial overt surface anaphora category of Hankamer and Sag.<sup>1</sup> The phenomenon, which we call Verb Phrase Pronominalization (henceforth VPP), is illustrated in (1)-(2).<sup>2</sup>

- (1) *Han siger han kan hækle, men selvfølgelig kan han ikke det.*  
 he says he can crochet but of course can he not DET  
 'He says he can crochet, but of course he can't.'

- (2) *Han siger han kan hækle, men det kan han ikke.*  
 he says he can crochet but DET can he not  
 ‘He says he can crochet, but he can’t.’

In (1), the proform *det* occurs in place of a verb phrase and stands in an anaphoric relationship to the verb phrase of the preceding clause. The anaphoric *det* can also appear in clause-initial position, as shown in (2).

In §2, we consider the possibility that the *det* proform is an instance of deep anaphora and point out some challenges to this approach. In §3, we show that a surface anaphora analysis of *det* is supported by Hankamer and Sag’s original diagnostics, though certain restrictions on extraction out of VPP remain unexplained. In §4, we argue that these restrictions are the result of the interplay between VPP and the verb second phenomenon. We discuss in some detail what this interaction reveals about how locality should be defined. A short conclusion follows in §5.

## 2. Deep Anaphoric Properties of VPP

Two properties of Danish VPP suggest that it is a deep anaphor. One is that it involves an overt proform, the other that certain kinds of extraction from inside the anaphor are impossible. We discuss each in turn.

As noted above, Hankamer and Sag (1976) classify English VPE and Sluicing as surface anaphors and English *it* and *one* anaphora as deep anaphors. From this, it is tempting to infer that surface anaphora is always null, whereas deep anaphora may involve a phonologically overt proform. If so, the fact that Danish VPP involves the proform *det* could be taken as evidence that it is deep. However, Hankamer and Sag argue explicitly (393, 411-418) that the distinction between deep and surface anaphora cannot be correlated with the presence versus absence of an overt proform. As an example of a phonologically null deep anaphor, they cite Null Complement Anaphora (e.g. *I asked Bill to leave, but he refused Ø*). Relevant to our purposes here, they also claim that there are phonologically overt surface anaphors, a category they exemplify with English *so* in both its sentential (*believe so*) and verb phrase (*do so*) uses. Kehler and Ward (1999:246-249, 2004:394-397) challenge this classification. They argue that *so* anaphora exhibits mixed behavior: it behaves like a surface anaphor in requiring a linguistic antecedent, but, unlike other surface anaphors, does not require syntactic parallelism between the antecedent and target clauses. If we accept Kehler and Ward’s arguments, there are no clear instances of overt surface anaphora in Hankamer and Sag’s original taxonomy, and one would therefore be tempted to count the overtness of VPP as evidence against it being a surface anaphor.

The second property of VPP that seems to point to it being deep anaphora has to do with extraction. According to Hankamer and Sag, surface anaphors have



internal structure in the early stages of the derivation, while deep anaphors are syntactically atomic. If so, one would expect it to be possible, at least in principle, to extract constituents out of a surface anaphor; in English VPE, for instance, wh-extraction from the site of ellipsis is grammatical, though certain information structural conditions apply (Schuyler 2001). For deep anaphors, no subextraction should be possible: if there is no internal structure, there is nothing to extract. In this light, consider the examples in (3) and (4), which show  $\bar{A}$ -extraction of the direct and indirect object respectively:<sup>3</sup>

- (3) \**Jeg ved hvem Susan kildede, men jeg ved ikke hvem Palle*  
 I know who Susan tickled but I know not who Palle  
*gjorde det.*  
 did DET  
 Intended: 'I know who Susan tickled but I don't know who Palle did.'
- (4) \**Jeg ved hvem Susan lånte bilen til, men jeg ved ikke hvem*  
 I know who Susan lent car.DEF to but I know not who  
*Palle gjorde det.*  
 Palle did DET  
 Intended: 'I know who Susan lent the car to, but I don't know who Palle did.'

Such examples are uniformly ungrammatical, indicating that the  $\bar{A}$ -extraction of verb phrase-internal arguments is impossible in the context of VPP. If VPP is a deep anaphor standing in for a  $\nu$ P, we have a straightforward explanation for this fact: extraction from inside the  $\nu$ P anaphor is impossible because there is no syntactic structure inside the anaphor and hence nothing to extract. In other words, there is no base position for the second *hvem* in (3) and (4).

The restriction observed for the  $\bar{A}$ -movement of verb phrase-internal elements does not hold, however, for A-movement. VPP is possible with unaccusative verbs (5) and passives verbs of both the analytical type formed with the auxiliary *blive* (6a) and the synthetic type formed with the suffix *-s* (6b). (The antecedent is bracketed in the examples below.)

- (5) *Bare toget ville [bryde sammen lige nu]! Men det*  
 just train.DEF would break together right now but DET  
*gjorde det selvfølgelig ikke!*  
 did it of.course not  
 'If only the train would break down right now! But of course it didn't!'
- (6) a. *Det var første gang, jeg ønskede at blive [afsat på*  
 it was first time I wanted to become dismissed on  
*stedet], og det blev jeg.*  
 place.DEF and DET became I  
 'It was the first time I had wanted to be dismissed on the spot and I was.'

- b. *Staten skal betale 100 mio. kr, hvis planen skal*  
 state.DEF must pay million Kroner if plan.DEF must  
*[gennemføres på normeret tid]. Og det skal den...*  
 implement.PASS on normal time and DET must it  
 ‘The state must pay 100 million Kroner if the plan is to be implemented  
 within the allocated time period. And it must be...’

At the core of transformational approaches to passives and unaccusatives is the assumption that their subjects originate inside the VP. If so, the fact that VPP is possible with unaccusatives and passives speaks against *det* being a syntactically atomic proform standing in for a verb phrase, and consequently against the deep anaphora analysis. This point holds even if passive and unaccusatives are taken to be derived not by A-movement but by (short) null-operator movement as proposed by Neeleman and Weerman (1998:145-178). A similar argument for the surface anaphoric status of a verb phrase anaphor can also be made within a nontransformational framework like LFG (Lødrup 1994).

The same issue arises for the subjects of transitive and unergative verbs as well, since, by hypothesis, they are merged in Spec-*vP* and then raise to subject position in T. In this case, one could appeal to the possibility that the VPP proform stands in for a smaller constituent than *vP*. If *det* is actually a VP, then external arguments, which originate outside of it, would be able to escape VPP, even under a deep anaphora analysis. The problem with this analysis is that it holds no promise of extending to the unaccusative and passive cases: there is no smaller constituent inside the *vP* in (5)-(6) that contains the verb and verb phrase-internal adjuncts, but not the internal argument. We therefore do not pursue it further.

To maintain the deep anaphora analysis of VPP in light of the data above, we would have to abandon the widely held assumption that the patient subjects of unaccusatives and passives are merged inside the verb phrase. These subjects would have to originate outside the target of VPP: VP or *vP*. Either possibility raises nontrivial questions about how these subjects receive their  $\theta$ -role.

A similar challenge to the deep anaphora analysis comes from the possibility of VPP with a raising predicate like *lade til* ‘seem’, as shown in (7).

- (7) *Han lader til at have glemt alt om aftalen, men det*  
 he seems to that have forgotten all about deal.DEF but DET  
*gør hun ikke.*  
 does she not  
 ‘He seems to have forgotten all about the deal, but she doesn’t.’

If *det* is a deep anaphor, it is a mystery where *hun* ‘she’ originates before raising to the matrix subject position of the target clause, since there is no embedded Spec-*vP* to host it.

To summarize, the fact that VPP involves an overt proform is weak evidence that it is a deep anaphor. A deep anaphora analysis would also explain why the target of VPP does not allow for the  $\bar{A}$ -extraction of internal arguments, though the same analysis would force us to abandon a movement analysis of passives and unaccusatives, and raising predicates as well, and more generally to question the idea that  $\theta$ -role assignment is correlated with the base position of an argument.

### 3. Surface Anaphoric Properties of VPP

Turning now to consider the possibility that VPP is a surface anaphor, we find four sources of evidence for this position: 1) it exhibits the Missing Antecedent Phenomenon; 2) it strongly prefers a linguistic antecedent; 3) it requires parallelism in transitivity between the antecedent and target clauses; and 4) it allows A-extraction of verb phrase-internal arguments to subject position. Since the extraction data has already been discussed in the previous section (see (5)-(7)), in this section we will discuss only the first three pieces of evidence, which comprise Hankamer and Sag's original diagnostics for distinguishing deep and surface anaphora.

The first of Hankamer and Sag's diagnostics is that surface anaphora exhibits the Missing Antecedent Phenomenon (see Johnson (2001:455-456) for qualifications). This test refers to the configuration in which a pronoun finds its referent within the site of the anaphor. This is possible with VPP, as shown in the example of (8).

- (8) *Jeg har aldrig redet på en kamel, men det har Ivan og han  
I have never ridden on a camel but DET has Ivan and he  
siger at **den** stank forfærdeligt.  
says that it stank terribly  
'I've never ridden a camel, but Ivan has and he says it stank terribly.'*

Intuitively, the bolded pronoun *den* 'it' refers to the camel that Ivan rode. It therefore must be getting its reference from a DP contained within the target of VPP. (The indefinite DP *a camel* in the first clause of the conjunct is not a possible antecedent for the pronoun since it is under the scope of negation and so does not introduce a discourse referent.) For this to be the case, the site of VPP must have full syntactic structure; it must be a surface anaphor.

The second characteristic of surface anaphors noted by Hankamer and Sag is that they strongly prefer a linguistic antecedent (see Merchant (2004:717-724) for a careful discussion and defense of this claim). The meaning of the anaphor cannot be inferred pragmatically from the real-world context. For VPP this is shown by the example in (9).

- (9) [A and B are observing C struggling to swim in a pool]  
 A: #*Det kan jeg heller ikke.*  
 DET can I either not  
 Intended: ‘I can’t swim either.’

For A’s utterance in (9) to be felicitous, either A or B must provide a linguistic antecedent (VPP like other surface anaphors is licit across speakers), saying something to the effect of *C sure can’t swim*. If no such antecedent is present, the sentence in (9) cannot be felicitously uttered.

The final diagnostic Hankamer and Sag provide is that surface anaphors require structural identity between the target and antecedent clauses. They only consider the requirement that the voice of the target and antecedent clauses be the same, a constraint that Kehler (2000, 2002) shows only holds when the target and antecedent clauses are in a Resemblance coherence relation. We avoid this complication by looking at mismatches in the transitivity of the target and antecedent clauses, which are always ungrammatical in English VPE:

- (10) \**Maria still tried to break the vase even though it wouldn’t [~~break~~].*

Danish VPP exhibits the same transitivity parallelism requirement. *Hænge* ‘hang’, like its English equivalent, alternates between transitive and intransitive forms. A clause containing the transitive form cannot serve as the antecedent to a VPP target clause containing the intransitive form:

- (11) \**Jeg ville hænge hesteskoen over døren og det gør den nu.*  
 I will hang horseshoe.DEF over door.DEF and DET does it now  
 Intended: ‘I wanted to hang the horseshoe over the door and it hangs there now.’

If the three tests discussed here are correct in diagnosing VPP as a surface anaphor, we would expect  $\bar{A}$ -extraction to be possible in sentences containing VPP (following Schuyler (2001)). This expectation is only partially borne out:  $\bar{A}$ -extraction is possible with subjects (12), but not with direct and indirect objects (3)-(4). Subject  $\bar{A}$ -extraction is possible whether the subject originates as the external argument (12a) or internal argument (12b) of the verb.

- (12) a. *Jeg kan ikke hækle, men hvem kan egentlig det nu om dage?*  
 I can not crochet, but who can actually DET now about days  
 ‘I don’t know how to crochet, but who actually does these days?’

- b. *Jeg ved at både Susan og Palle gerne ville vælges*  
 I know that both Susan and Palle happily would elect.PASS  
*til formand, men jeg ved ikke hvem af dem blev det.*  
 to chairman but I know not who of them became DET  
 'I know that both Susan and Palle wanted to be elected chairperson, but  
 I don't know which of them was.'

As with the A-extraction of passive and unaccusative subjects, if we consider the target of VPP to be VP, it is quite expected that  $\bar{A}$ -extraction of external argument subjects is always possible. These subjects originate outside the target of VPP and therefore can raise to Spec-TP and from there to Spec-CP whether VPP is a deep or surface anaphor. For internal argument subjects of the verb that undergo  $\bar{A}$ -extraction, however, we are led to the conclusion that VPP must be an instance of surface anaphora. Again, pursuing a deep anaphora analysis of VPP in light of these facts would require us to abandon a movement analysis of the subjects of unaccusatives and passives, as well as the correlation between  $\theta$ -role assignment and the position where an argument is merged.

More problematic for the surface anaphora analysis of VPP is the fact discussed above, that  $\bar{A}$ -extraction of direct and indirect objects is not possible, as shown in (3) and (4). (This cannot be seen as a general ban on the  $\bar{A}$ -extraction of internal arguments since we have just seen that the  $\bar{A}$ -extraction of subjects that originate as the internal argument of the verb is possible.) This fact seems to suggest that VPP is a deep anaphor, for if there were no VP-internal structure, there would be no direct or indirect objects available for extraction. Despite the fact that nonsubject VP-internal  $\bar{A}$ -extraction is ungrammatical, we believe that a surface anaphor analysis of VPP is possible. Arriving at this resolution requires us to look more closely at the interaction between VPP and verb second—a task we take up in the next section.

#### 4. Locality and Competition for Spec-CP

As noted in the introduction, the proform *det* that stands in for the verb phrase in VPP can appear in two positions: in canonical verb phrase position (1) or in clause-initial position (2). When *det* appears clause-initially, we analyze this as an instance of movement to Spec-CP, accompanied by movement of the finite verb to C. Instances where *det* appears unfronted arise when some other element occupies Spec-CP; this can be a *wh*-phrase (12), an adverbial like *selvfølgelig* (1), the antecedent of a conditional (13), the null operator of a polar question (14),<sup>4</sup> or a (contrastive) topic subject (15).

- (13) [<sub>CP</sub> *Hvis det viser sig at være nødvendigt at flytte*  
 if it shows REFL to be necessary to move *hov-*  
*edkontoret til USA*], *gør vi måske det...*  
 head.office.DEF to USA do we perhaps DET  
 ‘If it turns out to be necessary to move the head quarters to the US, we  
 might (do so)...’
- (14) [Lise Carlsen:] “...*Om fødslen måske er gået i gang*  
 whether birth.DEF maybe is gone in step  
*for tidligt.*” *Hans hjerte begyndte at hamre.* *Som om han havde*  
 too early his heart started to pound as if he had  
*løbet langt og hurtigt.* [Per Toflund:] “*Er den det?*”  
 run far and fast is it DET  
 “...If labor has perhaps started early.” His heart started to pound as if he  
 had run far and fast. “Has it?”
- (15) *En del af dem klarer sig, andre gør det ikke.*  
 a part of them deal.with REFL others do DET not  
 ‘Some of them manage, others don’t.’

The purpose of this section is to understand why these elements block movement of *det* to Spec-CP, which in turn will lead to an understanding of why the  $\bar{A}$ -extraction of nonsubject internal arguments is not possible with VPP.

Since *det* can participate in fronting that is accompanied by verb second, and since this movement is generally assumed to be for discourse purposes (Platzack 2000; Rizzi 1997), we assume that the  $\nu$ P targeted by VPP is topic-marked, bearing a topic feature [top]. This assumption is supported by the fact that VPP requires a linguistic antecedent that is semantically identical, in some sense, to the target, which will therefore always be given information (see Merchant (2001:13-37) for discussion of the givenness requirement on ellipsis). We propose that the feature driving the movement of *det* to Spec-CP is a generalized [ $u\bar{A}$ ] feature on C. This feature can be satisfied by merging or moving a phrase that bears an interpretable topic, focus, or *wh* feature into Spec-CP.<sup>5</sup>

Positing a single [ $u\bar{A}$ ] feature on C captures the fact that various elements in a clause compete for a single discourse position in Danish: Spec-CP. If there is only one [ $u\bar{A}$ ] feature, then once it has been checked locally by a single discourse-marked element merged or moved into the specifier of C, all other discourse-marked elements in the clause, such as the anaphoric *det*, will be ineligible for movement and will remain in situ.

With this much in place we can now understand why  $\bar{A}$ -extraction of the direct and indirect objects in (3) and (4) is ungrammatical. If  $\nu$ P bears a [top] feature and the internal argument bears a [wh] feature, movement of the internal argument past  $\nu$ P to Spec-CP in order to satisfy the [ $u\bar{A}$ ] feature on C would be a violation of locality. This is shown in (16), the structure for the sentence in (3).

(16) *Jeg ved hvem Susan kildede, men jeg ved ikke...*

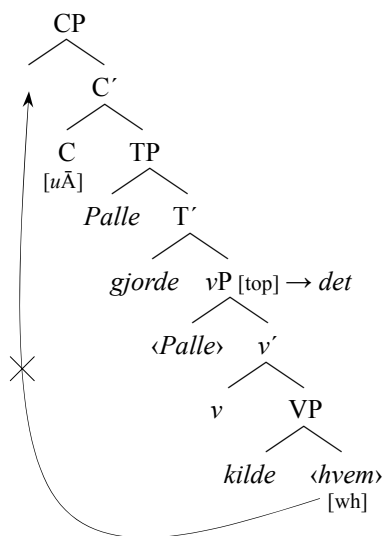

Intuitively, it seems clear that the ungrammaticality of (3)/(16) is due to a violation of locality; the topic marked  $vP$  is higher in the tree than *hvem* and therefore appears to be closer to Spec-CP. It is not possible, however, to square this with the most widely assumed definition of locality, one formulation of which is given in (17).<sup>6</sup>

- (17) G is the closest category in the sister of H iff there is no distinct category K such that K c-commands G and K bears a feature matching F.  
(Fitzpatrick 2002:446)

In this definition, G is a possible goal, corresponding to  $vP$ , or *hvem* in (16), H is the probe, here C, which hosts the attracting feature F, here  $[u\bar{A}]$ . If we apply (17) to (16) we see that both  $vP$  and *hvem* qualify as closest categories to C, since in neither case is there a K that c-commands  $vP$  or *hvem* and bears a feature matching  $[u\bar{A}]$ . In the case of  $vP$ , this is because neither of the two elements that c-command  $vP$ , namely the subject (*Palle*) and the finite verb (*gjorde*), bears a feature matching  $[u\bar{A}]$ . In the case of *hvem*, this is because the one element that bears the relevant feature,  $vP$ , does not c-command *hvem*. Consequently, under the definition of locality in (17), the topic-marked  $vP$  and wh-phrase *hvem* are equidistant from C and it is predicted that either would be able to move to Spec-CP, contrary to fact. Any definition of locality that relies on an intervening c-commanding element will have the same problem in accounting for (16), since  $vP$  does not c-command *hvem*.

vP does, however, contain *hvem* and containment has been proposed to be relevant for some conditions on movement, most notably the A-over-A Principle (Chomsky 1973:235). It states that if there are two phrases of the same category, both of which are possible targets of a particular operation and if one phrase contains the other, then it is the maximal phrase that the operation applies to. Relevant for our purposes, Bresnan (1976) generalizes this principle in her Relativized A-over-A Principle to apply to operations that make reference to non-categorial labels. It thus applies in configurations like the one in (16).<sup>7</sup> Both the topic-marked vP and the wh-word *hvem* bear discourse features that are possible goals for the [ $u\bar{A}$ ] feature. Only movement of vP is grammatical, as it contains *hvem*.

While Bresnan's intuitions cannot be captured by the definition of locality in (17), at least one current definition of locality does—that of Epstein et al. (1998), which is based on reducing the number of mutual c-command relations that are created. For them, when two elements are eligible for movement, the more local of the two is the one whose movement results in the creation of the fewest number of mutual c-command relations. Mutual c-command relations arise in two ways. The first is when two items are merged; sisters always mutually c-command each other. The other configuration that yields a mutual c-command relationship is when A c-commands B and B c-commands a copy of A.<sup>8</sup> In (16), for instance, *Palle* and *gjorde* mutually c-command each other because the occurrence of *Palle* in Spec-TP c-commands *gjorde*, which in turn c-commands the occurrence of *Palle* in Spec-vP. With this definition of locality in mind, movement of *hvem* to Spec-CP results in the creation of six mutual c-command relations (between *hvem* and *kilde*, *v*, *gjorde*, *Palle*, C, and C'), while movement of vP to Spec-CP results in the creation of only four mutual c-command relations (between vP and *gjorde*, *Palle*, C, and C'). Movement of vP to Spec-CP creates two fewer mutual c-command relations than the movement of *hvem*, and therefore vP is more local to C than *hvem*.

Note that this formulation of locality predicts the ungrammaticality of (3)-(4) even if movement to Spec-CP of an item contained within vP proceeds through Spec-vP (Chomsky 2000, 2001; Legate 2003; Rackowski and Richards 2005). Under the definition in (17), the topic-marked vP and the wh-word *hvem* in its specifier are equidistant from C, since a maximal category does not c-command its specifier. Either should be able to raise, which as we saw in (3)-(4) is not possible. This is not an issue with the formulation of locality proposed by Epstein et al.; movement of *hvem* from Spec-vP creates eight mutual c-command relations (between *hvem* and *kilde*, *v*, *Palle* in Spec-vP, vP, *gjorde*, *Palle* in Spec-TP, C, and C') while movement of vP creates only five (between vP and *hvem*, *gjorde*, *Palle*, C, and C').

Adopting Epstein et al.'s definition of locality allows us to account for the ungrammaticality of direct and indirect object  $\bar{A}$ -extraction under VPP while maintaining an analysis of VPP as surface anaphora. We also understand why subject



extraction is always possible. Movement of the subject to Spec-TP is A-movement—it is driven by the EPP, a feature for which the topic-marked *vP* is not an eligible goal. Once the subject is in Spec-TP, if it is discourse-marked (as it is in the sentences in (12)), it will be closer to C than *vP*.

## 5. Conclusion

Our main conclusion is that the anaphoric proform *det* in Danish VPP—which at first appears to be a deep anaphor—is in fact a surface anaphor.

The major obstacle to analyzing *det* as surface anaphora is the impossibility of VPP accompanied by the  $\bar{A}$ -movement of verb phrase-internal elements. We propose that this difficulty can be overcome by considering the interaction between VPP and the verb second properties of Danish. The proform *det* competes with other elements in the sentence for Spec-CP and, under a definition of locality like that of Epstein et al. (1998), it will be closer to C than any discourse-marked elements contained within it, including direct and indirect object wh-phrases.

If our argument goes through, Danish VPP provides important confirmation of Hankamer and Sag's typology of anaphora, since it instantiates the overt surface anaphora category, whose existence was otherwise in question.

## Notes

\* We thank Dan Hardt, Kyle Johnson, Idan Landau, and Helge Lødrup for their comments on the material presented here, as well as audiences at the 21st Comparative Germanic Syntax Workshop, WECOL 2006, the Berkeley Syntax and Semantics Circle, the University of Massachusetts, Amherst, and the University of California, Santa Cruz.

<sup>1</sup> Danish VPP has been observed in the descriptive literature (Hansen 1967:31; Diderichsen 1968:178; Allan et al. 1995:158-159), but no theoretical treatment has been offered to date. A range of descriptively similar verb phrase anaphoric constructions are found throughout the Germanic languages, e.g. auxiliary plus *det* in Norwegian (Lødrup 1994), Swedish *göra det* (Källgren and Prince 1989), the German *es* construction (Winkler 1998; López and Winkler 2000), Dutch Short Do Replies (van Craenenbroeck 2004:125-260), and English *do it* and *do so* (Kehler and Ward 1999, 2004). Despite surface similarity, each of these constructions seems to differ in some respect from Danish VPP. We therefore cannot assume that our conclusions about VPP will carry over to any of them. Comparative work on this topic is clearly called for.

<sup>2</sup> The abbreviations used in this paper are: DEF, definite; DET, the VPP proform *det*; PASS, passive; REFL, reflexive. Our data come largely from the Korpus 2000 corpus. Some examples have been modified for reasons of space and exposition. Additional judgments come from native Danish speakers consulted in the United States.

<sup>3</sup> Note that in (4) the antecedent clause has the form V DP<sub>DO</sub> PP<sub>IO</sub>. Danish also has a double object construction of the form V DP<sub>IO</sub> DP<sub>DO</sub>, but when extracting the recipient/goal argument the former is preferred. It is unclear whether we are justified in calling this indirect object extraction, but what is important for our purposes is that the extractee originates inside the verb phrase.

<sup>4</sup> Leif Davidsen, *De gode søstre*, p. 147.

<sup>5</sup> The generalized [ $u\bar{A}$ ] feature can be implemented formally as an unvalued feature on C that can be valued by a range of interpretable features like [wh] and [top], much like an uninterpretable case feature.

<sup>6</sup> This formulation, due to Fitzpatrick (2002), is similar to the locality condition that Chomsky (2001) places on the agree relation. There are a number of other definitions that are similar in spirit to (17), which are similarly not able to capture the intuition that topic-marked  $vP$  is closer to C than a discourse-marked DP contained within it (see Doggett (2004:7) and references cited there).

<sup>7</sup> We thank Kyle Johnson for pointing this out to us.

<sup>8</sup> This formulation of locality differs from the original formulation of Epstein et al. in that it is representational, while theirs is stated in purely derivational terms. Despite this difference, we believe that our formulation is in the spirit of the original authors' and that it has the same empirical coverage.

## References

- Allan, Robin, Philip Holmes, and Tom Lundskaer-Nielsen. 1995. *Danish: A comprehensive grammar*. London: Routledge.
- Bresnan, Joan. 1976. "On the form and functioning of transformations", *Linguistic Inquiry*, 7:3-40.
- Chomsky, Noam. 1972. "Conditions on Transformations", *A Festschrift for Morris Halle*, Stephen R. Anderson and Paul Kiparsky, eds., New York: Rinehart and Winston.
- Chomsky, Noam. 2000. "Minimalist inquiries: The framework", *Step by step: Essays on minimalist syntax in honor of Howard Lasnik*, Roger Martin, David Michaels, and Juan Uriagereka, eds., Cambridge, MA: MIT Press, 89-156.
- Chomsky, Noam. 2001. "Derivation by phase", *Ken Hale: A life in language*, Michael Kenstowicz, ed., Cambridge, MA: MIT Press, 1-52.
- van Craenenbroeck, Jeroen. 2004. *Ellipsis in Dutch dialects*. Ph.D. dissertation, University of Leiden.
- Depiante, Marcela A. 2000. *The syntax of deep and surface anaphora: A study of Null Complement Anaphora and Stripping/Bare Argument Ellipsis*. Ph.D. dissertation, University of Connecticut.
- Diderichsen, Paul. 1968. *Elementær Dansk Grammatik, 3rd edn*. København: Gyldendal.
- Doggett, Teal Bissell. 2004. *All things being unequal: Locality in movement*. Ph.D. dissertation, Massachusetts Institute of Technology.
- Epstein, Samuel David, Erich M. Groat, Ruriko Kawashima, and Hisatsugu Kitahara. 1998. *A derivational approach to syntactic relations*. Oxford: Oxford University Press.
- Fitzpatrick, Justin M. 2002. "On Minimalist approaches to the locality of movement", *Linguistic Inquiry*, 33:443-463.
- Goldberg, Lotus. 2005. *Verb-Stranding VP Ellipsis: A cross linguistic study*. Ph.D. dissertation, McGill University.
- Hankamer, Jorge and Ivan A. Sag. 1976. "Deep and surface anaphora", *Linguistic Inquiry*, 7:391-426.
- Hansen, Aage. 1967. *Moderne Dansk, vol. III*. København: Det Danske Sprog- og Litteraturselskab/Grafisk Forlag.
- Johnson, Kyle. 2001. "What VP-ellipsis can do, what it can't, but not why", *The handbook of contemporary syntactic theory*, Mark Baltin and Chris Collins, eds., Oxford:

- Blackwell, 439-479.
- Källgren, Gunnel and Ellen F. Prince. 1989. "Swedish VP-topicalization and Yiddish verb-topicalization", *Nordic Journal of Linguistics*, **12**:47-58.
- Kehler, Andrew. 2000. "Coherence and the resolution of ellipsis", *Linguistics and Philosophy*, **23**:533-575.
- Kehler, Andrew. 2002. *Coherence, reference, and the theory of grammar*. Stanford, CA: CSLI.
- Kehler, Andrew and Gregory Ward. 1999. "On the semantics and pragmatics of 'identifier so'", *The semantics/pragmatics interface from different points of view*, Ken Turner, ed., Amsterdam: Elsevier, 233-256.
- Kehler, Andrew and Gregory Ward. 2004. "Constraints on ellipsis and event reference", *Handbook of pragmatics*, Laurence R. Horn and Gregory Ward, eds., Oxford: Blackwell, 383-404.
- Legate, Julie Anne. 2003. "Some interface properties of the phase", *Linguistic Inquiry*, **34**:506-516.
- Lødrup, Helge. 1994. "'Surface proforms' in Norwegian and the definiteness effect", *Proceedings of the North East Linguistics Society*, Mercé González, ed., **24**:303-315.
- López, L. and S. Winkler. 2000. "Focus and topic in VP-anaphora constructions", *Linguistics*, **38**:623-664.
- Merchant, Jason. 2001. *The syntax of silence: Sluicing, islands, and the theory of ellipsis*. Oxford: Oxford University Press.
- Merchant, Jason. 2004. "Fragments and ellipsis", *Linguistics and Philosophy*, **27**:661-738.
- Neeleman, Ad and Fred Weerman. 1998. *Flexible syntax: A theory of case and arguments*. Dordrecht: Kluwer.
- Platzack, Christer. 2000. "Multiple interfaces", *Cognitive interfaces*, Urpo Nikanne and Emilie van der Zee, eds., Oxford: Oxford University Press, 21-53.
- Rackowski, Andrea and Norvin Richards. 2005. "Phase edge and extraction: A Tagalog case study", *Linguistic Inquiry*, **36**:565-599.
- Rizzi, Luigi. 1997. "The fine structure of the left periphery", *Elements of grammar: Handbook of Generative syntax*, Liliane Haegeman, ed., Dordrecht: Kluwer, 281-337.
- Sag, Ivan A. and Jorge Hankamer. 1984. "Toward a theory of anaphoric processing", *Linguistics and Philosophy* **7**:325-345.
- Schuyler, Tamara. 2001. "Wh-movement out of the site of ellipsis", *Syntax and Semantics at Santa Cruz*, Séamas Mac Bhloscaidh, ed., **3**:1-20.

Michael J. Houser, Line Mikkelsen, and Maziar Toosarvandani  
 Department of Linguistics  
 1203 Dwinelle Hall  
 Berkeley, CA 94720-2650  
 mhouser@berkeley.edu  
 mikkelsen@berkeley.edu  
 mtoosarvandani@berkeley.edu

# Winners Take All: “Missing Paradigms” in Jinghpo

Feng-fan Hsieh

Massachusetts Institute of Technology

## 1. Introduction

It is not unusual to see that cells in an inflectional paradigm are filled by allomorphy, periphrasis, or suppletion. In the “worst case” scenario, paradigmatic gaps (i.e. absolute ungrammaticality or ineffability) occur if *all* candidates lose out. This paper is an attempt to describe and analyze yet another logically possible but previously unreported phenomenon whereby holes in a paradigm are filled by periphrasis and as a consequence the whole paradigm is rendered “absent.” More precisely, given an inflectional paradigm *P*, it is not permissible to realize some cells in synthetic forms and the other cells in periphrastic forms in *P*. I.e. the whole paradigm must be expressed periphrastically. I shall demonstrate and argue that this is the case in Jinghpo (also known as *Jingpo* or *Kachin*), a Tibeto-Burman language spoken in Yunnan Province of China, Myanmar, and India (Dai and Xu 1992, p.1-2).

The organization of this paper is as follows. In section 2, some essential characteristics of the “Functional Complex” (the inflectional paradigms in question) are outlined, followed by a demonstration of the main concern of this paper, “missing paradigms,” together with some discussion of plausible accounts from various angles. An OT-based analysis is given in section 3. Finally, section 4 concludes this paper.

## 2. Statement of problem

Jinghpo is a head-final language. Inflectional morphemes and mood markers appear in sentence-final position. In this paper, the clustering of these morphemes is dubbed the Functional Complex. Its internal structure is schematized as follows.<sup>1</sup>

(1) [Number-(Aspect/Direction)-Person-Mood]

Jinghpo inflects two numbers (singular and plural), two aspects (imperfective and perfective), two directionals (centripetal and centrifugal) and three persons (first, second and third). In addition, Jinghpo has six mood expressives, namely, declarative, interrogative, inferential, exclamative, imperative and jussive.

Directionals seem less familiar. They can be treated as the egocentric perspective-taking device, on a par with Anand and Hsieh's (2005) and Garrett's (2001) discussion on Mandarin and Tibetan, respectively. In general, centripetal forms are used in the context of "Verb towards the speaker," while centrifugal forms are used in the context of "Verb away from the speaker." Notice that aspectual and directional morphemes are in *complimentary distribution*. I.e. temporal stance (aspectuals) does not cooccur with locational stance (directionals).

To see what the Functional Complex really look like, some examples are given below. The Functional Complex is in bold, with the parenthesized underlying representation.<sup>2</sup>

- (2) a. màʒaŋ t<sup>h</sup>ùʔ wà **ʒàʔai** ( $\phi$ -ʒà-àʔ-ai)  
rain fall INCHO SG.CENTRIPETAL.3.DECL  
'It is/starts raining.' (D&X 1992, p.285)
- b. ʃi tʃàŋ lùŋ **sai** ( $\phi$ -sá-àʔ-ai)  
he school attend SG.PF.3.DECL  
'He went to school.' (D&X 1992, p. 272)
- c. naŋ mùŋ tʃiŋp<sup>h</sup>òʔ ʒáí **ñní** ( $\phi$ - $\phi$ -in-ní)  
you also Jinghpo be SG.IMPF.2.INTEROG  
'Are you also Jinghponese?' (D&X 1992, p. 304)

There are several things to note in these examples. In (2a), the verb and the Functional Complex are intervened by the inchoative particle *wà*, indicating that the verb is not amalgamated with the Functional Complex. In fact, adverbs can appear in the same position, too. Mei (1996) takes this as evidence for lack of verb movement in Jinghpo. With respect to our concern, we can say that the Functional Complex is *independent* of the verb. Also, the Functional Complex can be regarded as a closed system due to the fact that there are four slots and a finite set of morphemes. Accordingly, it is not necessary to define inflectional paradigms in Jinghpo as "all and only the words based on a single lexeme" (McCarthy 2005, p.173, among many others). Instead, the Functional Complex as such is inflectional paradigm.

Furthermore, as mentioned earlier, directionals do not cooccur with aspectual forms (and vice versa). As seen in (2b), no directional marking appears, in particular, the centrifugal marker *sà*, even though this event evidently correlates with directionality. By contrast, the centripetal marker *ʒà* is used in (2a), because rain drops fall on the ground, which is taken as an egocentric locus of the speaker. This confirms our previous description that a directional-marked sen-

tence can stand alone without recourse to temporal reference (and again vice versa). Finally, sentential force is expressed by different mood expressives. For instance, in an interrogative sentence like (2c), the interrogative mood marker *nî* is used, instead of, say, the declarative mood marker *ai*. With the discussion in mind, some sample paradigms are demonstrated in the following section.

### 2.1. Introducing missing paradigms

As explicitly mentioned at the outset, certain paradigms must be expressed periphrastically in Jinghpo. Let us first look at some “non-periphrastic” paradigms. In (3), there are two subparadigms, namely, Imperfective Declaratives and Perfective Declaratives (subject agreement; see more discussion in (18)). The underlying morpheme concatenation is again given in parentheses. Owing to space limit, a detailed analysis of the relevant morphophonological processes cannot be offered here. Since these processes are extremely regular, the parenthesized forms are given with confidence (cf. Mei 1996). As a reminder, the internal structure of the Functional Complex is [Number-(Aspect/Direction)-Person-Mood].

#### (3) Aspectual Declaratives

|   | <u>Imperfective Declaratives</u>   |                                         | <u>Perfective Declaratives</u> |                           |
|---|------------------------------------|-----------------------------------------|--------------------------------|---------------------------|
|   | SG                                 | PL                                      | SG                             | PL                        |
| 1 | îŋŋai<br>( $\phi$ - $\phi$ -îŋ-ai) | kà?ai<br>( $\phi$ -kà <sup>3</sup> -ai) | saŋai<br>( $\phi$ -sà-îŋ-ai)   | sákà?ai<br>(sà-kà?-ai)    |
| 2 | ntai<br>( $\phi$ - $\phi$ -in-ai)  | màtai<br>(mà- $\phi$ -in-ai)            | sintai<br>( $\phi$ -sà-in-ai)  | masintai<br>(ma-sà-in-ai) |
| 3 | ai<br>( $\phi$ - $\phi$ -à?-ai)    | mà?ai<br>(mà- $\phi$ -à?-ai)            | sai<br>( $\phi$ -sà-à?-ai)     | masai<br>(ma-sà-à?-ai)    |

For a real example of Aspectual Declaratives, see (2b). Let us now turn to Directional Declaratives. Surprisingly, *Centrifugal Declaratives* are not available (the dotted box). These forms are expressed periphrastically (Dai Qingxia, p.c.).

#### (4) Directional Declaratives

|   | <u>Centripetal Declaratives</u> |                           | <u><i>Expected Centrifugal Forms</i></u> |                                  |
|---|---------------------------------|---------------------------|------------------------------------------|----------------------------------|
|   | SG                              | PL                        |                                          |                                  |
| 1 | zîŋŋai<br>( $\phi$ -zà-îŋ-ai)   | zàkà?ai<br>(zà-kà?-ai)    | <i>sîŋŋai</i><br>( $\phi$ -sà-îŋ-ai)     | <i>sàkà?ai</i><br>(sà-kà?-ai)    |
| 2 | zintai<br>( $\phi$ -zà-in-ai)   | màzintai<br>(ma-zà-in-ai) | <i>sintai</i><br>( $\phi$ -sà-in-ai)     | <i>masintai</i><br>(ma-sà-in-ai) |
| 3 | zà?ai<br>( $\phi$ -zà-à?-ai)    | màzà?ai<br>(ma-zà-à?-ai)  | <i>sà?ai</i><br>( $\phi$ -sà-à?-ai)      | <i>màsà?ai</i><br>(ma-sà-à?-ai)  |

To see how a periphrastic form looks like, some relevant data are demonstrated as follows.

- (5) a. *tù*            *zìŋŋai*,                            *tsùpp<sup>h</sup>òŋ p<sup>h</sup>òŋ sáká?*  
 arrive    SG.CENTRIPETAL.1.DECL    meeting    meet    EMPH.1PL.JUSS  
 ‘Here I am. Let us have the meeting!’ (D&X 1992, p. 285)
- b. *ǰánt<sup>h</sup>e*    *jòŋ*    *wà*    *màt*                            **masai**  
 they    all    return    PRT<sub>SELF-COMPLETION</sub>    PL.PF.3.DECL  
 ‘They all returned (home).’ (D&X 1992, p. 139)

(5a) is a typical context to use the centripetal marking. However, the *centrifugal* marker *sà* (note that it is low-toned) does not appear in (5b), an appropriate context for the centrifugal marking. One may wonder if that can be attributed to the possibility whereby the choice between aspectual and directional markings may be optional, or conditioned by some other unknown factors. In actuality, the expected form *màsà?ai* (UR: ma-sà-à?-ai; PL-CENTRIFUGAL-3-DECL) *never ever* surface. Instead, the Jinghpo speakers resort to periphrasis to express the intended meaning. More precisely, the expected form *màsà?ai* is supplanted with the perfective declarative forms *masai* (UR: ma-sá-à?-ai; PL.PF.3.DECL) in (5b) and centrifugality is conveyed in the verb *wà* ‘return,’ which expresses “away from the speaker” in some fashion. Importantly, (5b) is not an isolated instance. As mentioned earlier, the *entire* centrifugal declarative paradigm simply does not exist (see also the dotted box in (4)).

By contrast, centripetal and centrifugal forms are both attested in Imperatives. See below.

#### (6) Directional Imperatives

- a. *nánt<sup>h</sup>e*    *jòŋ*    *sa*    *màzìt (mà-3à-it-ϕ)*  
 you (PL)    all    move    PL.CENTRIPETAL.2.IMP  
 ‘(You all) come here!’ (D&X 1992, p.291)
- b. *nánt<sup>h</sup>e*    *jòŋ*    *ǰi-p<sup>h</sup>é*    *sa*    *kàzum*    *màsù? (mà-sà-it-ϕ)*  
 you (PL)    all    he-OBJ    move    help    PL.CENTRIFUGAL.2.IMP  
 ‘(You all) go help him!’ (D&X 1992, p.292)

In (6b), the second person morpheme *it* (derived from *in* via denasalization, an Imperative-specific modification; cf. (3-4)) surfaces as the third person morpheme *ù?* (used with transitives). Again, a detailed analysis of this syncretism is beyond the scope of this paper. Nevertheless, the data should be sufficient to support the claim that centrifugal marking *is* attested in this language.

Armed with the foregoing discussion, we are now in a position to ask why and how some specific paradigms must be expressed periphrastically.

## 2.2. Discussion

As implicitly mentioned above, the distributions of the centrifugal forms, unlike the centripetal forms, are highly constrained. For an overall picture, observe now the following table.

(7) Distribution of the directionals

|             | DECL | INTERR | INFER | EXCL | IMP | JUSS |
|-------------|------|--------|-------|------|-----|------|
| Centripetal | Yes  | Yes    | Yes   | Yes  | Yes | Yes  |
| Centrifugal | N/A  | N/A    | N/A   | N/A  | Yes | Yes  |

As shown, the centrifugal forms are exclusively attested in Imperatives and Jussives, whereas the centripetal forms are compatible with all of the mood expressives. To account for this puzzle, some possibilities present us. For example, it may well be the case that Centrifugal Declaratives are ungrammatical because of some featural cooccurrence restriction. It is reasonable to assume that the morphosyntactic features denoting centripetality and centrifugality are under the same functional head (e.g. DirectionP). However, it is not clear why [INTERROGATIVE], for example, cannot coexist with [CENTRIFUGAL] and is perfectly compatible with [CENTRIPETAL]. More importantly, although it is obvious that Imperatives and Jussives bear the same sentential force, the rest of the mood markers, namely, Declaratives, Interrogatives, Inferentials and Exclamatives do not form a “natural class.” Of course, it is not unreasonable to treat non-imperative/jussive mood markers as a wildcard category or the like. Nevertheless, it remains to be seen why and how only some specific inflectional paradigms can be ruled out *as a whole* for purely semantic or syntactic reasons in a non-arbitrary way.

In addition, it is beneficial to consider some proposed factors regarding phonologically motivated defective paradigm (e.g. Albright 2003 and many others). Firstly, phonological ill-formedness is not at issue because as far as I can tell, those expected centrifugal paradigms are as well-formed as the attested paradigms. This objection holds for uncertainty of inflected forms as well. Secondly, semantic plausibility is not a plausible account, too. If centripetal marking can be used, it is not obvious why using centrifugal marking is problematic. Finally, frequency or familiarity cannot explain the present phenomenon as the Functional Complex is independent of the verb. A verb may be rare or archaic, but this is unlikely as far as inflectional morphemes are concerned.

I argue that the most straightforward reason why certain centrifugal forms are absent in (7) is homophony avoidance. To see why, consider now (8). Potential homophonous forms are boldfaced. Underlyingly, the perfective marker is *sá*, while the centrifugal marker is *sà*. It is conceivable that potential homophony is more likely to occur when these two morphemes involve (due to some phonotactic constraint such as vowel deletion, e.g. *sa-in* → *sin*). In contrast, the centripetal marker *ʒà* does not have phonetically similar neighbors. It naturally falls out



that the centripetal forms always surface because no potential homophony ever occurs.

|     |                                |                 |                                          |
|-----|--------------------------------|-----------------|------------------------------------------|
| (8) | <u>Perfective Declaratives</u> |                 | <u>Expected Centrifugal Declaratives</u> |
|     | SG                             | PL              | SG                                       |
|     | PL                             |                 | PL                                       |
| 1   | saŋai                          | sákáʔai         | <i>siŋŋai</i>                            |
|     | ( $\phi$ -sá-iŋ-ai)            | (sá-káʔ-ai)     | ( $\phi$ -sà-iŋ-ai)                      |
| 2   | <b>sintai</b>                  | <b>masintai</b> | <b>sintai</b>                            |
|     | ( $\phi$ -sá-in-ai)            | (ma-sá-in-ai)   | ( $\phi$ -sà-in-ai)                      |
| 3   | sai                            | masai           | <i>sà ʔai</i>                            |
|     | ( $\phi$ -sá-àʔ-ai)            | (ma-sá-àʔ-ai)   | ( $\phi$ -sà-àʔ-ai)                      |

In conclusion, the missing paradigms are better treated as a result of phonologically motivated defectiveness.

### 3. Analysis

We have hitherto arrived at the conclusion that homophony avoidance is a more promising account for missing paradigms. The gist of the analysis is schematized below. Given two paradigms  $P$  and  $Q$ , let us assume that there are homophonous cells, namely, I and J. By virtue of antihomophony, cells I and J in Paradigm  $Q$  are banned from surfacing. Let us represent them with the symbol “ $\emptyset$ ”. Now if the Paradigmatic Uniformity constraint is properly ranked, the result is that Paradigm  $Q$  will be leveled out *as a whole*. In other words, the entire paradigm is “wiped out.”

(9) Wiping out a paradigm

|                                                                                                          |             |                 |                           |   |   |   |   |                                                                                                                                                    |   |             |   |   |             |   |   |                                                                                                                                                                                                                                        |             |             |             |             |             |             |
|----------------------------------------------------------------------------------------------------------|-------------|-----------------|---------------------------|---|---|---|---|----------------------------------------------------------------------------------------------------------------------------------------------------|---|-------------|---|---|-------------|---|---|----------------------------------------------------------------------------------------------------------------------------------------------------------------------------------------------------------------------------------------|-------------|-------------|-------------|-------------|-------------|-------------|
| Paradigm $P$                                                                                             |             |                 |                           |   |   |   |   |                                                                                                                                                    |   |             |   |   |             |   |   |                                                                                                                                                                                                                                        |             |             |             |             |             |             |
| <table border="1"><tr><td>A</td><td>I</td><td>C</td></tr><tr><td>B</td><td>J</td><td>D</td></tr></table> | A           | I               | C                         | B | J | D | → | <table border="1"><tr><td>A</td><td>I</td><td>C</td></tr><tr><td>B</td><td>J</td><td>D</td></tr></table>                                           | A | I           | C | B | J           | D | → | <table border="1"><tr><td>A</td><td>I</td><td>C</td></tr><tr><td>B</td><td>J</td><td>D</td></tr></table>                                                                                                                               | A           | I           | C           | B           | J           | D           |
| A                                                                                                        | I           | C               |                           |   |   |   |   |                                                                                                                                                    |   |             |   |   |             |   |   |                                                                                                                                                                                                                                        |             |             |             |             |             |             |
| B                                                                                                        | J           | D               |                           |   |   |   |   |                                                                                                                                                    |   |             |   |   |             |   |   |                                                                                                                                                                                                                                        |             |             |             |             |             |             |
| A                                                                                                        | I           | C               |                           |   |   |   |   |                                                                                                                                                    |   |             |   |   |             |   |   |                                                                                                                                                                                                                                        |             |             |             |             |             |             |
| B                                                                                                        | J           | D               |                           |   |   |   |   |                                                                                                                                                    |   |             |   |   |             |   |   |                                                                                                                                                                                                                                        |             |             |             |             |             |             |
| A                                                                                                        | I           | C               |                           |   |   |   |   |                                                                                                                                                    |   |             |   |   |             |   |   |                                                                                                                                                                                                                                        |             |             |             |             |             |             |
| B                                                                                                        | J           | D               |                           |   |   |   |   |                                                                                                                                                    |   |             |   |   |             |   |   |                                                                                                                                                                                                                                        |             |             |             |             |             |             |
| Paradigm $Q$                                                                                             |             |                 |                           |   |   |   |   |                                                                                                                                                    |   |             |   |   |             |   |   |                                                                                                                                                                                                                                        |             |             |             |             |             |             |
| <table border="1"><tr><td>W</td><td>I</td><td>Y</td></tr><tr><td>X</td><td>J</td><td>Z</td></tr></table> | W           | I               | Y                         | X | J | Z | → | <table border="1"><tr><td>W</td><td><math>\emptyset</math></td><td>Y</td></tr><tr><td>X</td><td><math>\emptyset</math></td><td>Z</td></tr></table> | W | $\emptyset$ | Y | X | $\emptyset$ | Z | → | <table border="1"><tr><td><math>\emptyset</math></td><td><math>\emptyset</math></td><td><math>\emptyset</math></td></tr><tr><td><math>\emptyset</math></td><td><math>\emptyset</math></td><td><math>\emptyset</math></td></tr></table> | $\emptyset$ | $\emptyset$ | $\emptyset$ | $\emptyset$ | $\emptyset$ | $\emptyset$ |
| W                                                                                                        | I           | Y               |                           |   |   |   |   |                                                                                                                                                    |   |             |   |   |             |   |   |                                                                                                                                                                                                                                        |             |             |             |             |             |             |
| X                                                                                                        | J           | Z               |                           |   |   |   |   |                                                                                                                                                    |   |             |   |   |             |   |   |                                                                                                                                                                                                                                        |             |             |             |             |             |             |
| W                                                                                                        | $\emptyset$ | Y               |                           |   |   |   |   |                                                                                                                                                    |   |             |   |   |             |   |   |                                                                                                                                                                                                                                        |             |             |             |             |             |             |
| X                                                                                                        | $\emptyset$ | Z               |                           |   |   |   |   |                                                                                                                                                    |   |             |   |   |             |   |   |                                                                                                                                                                                                                                        |             |             |             |             |             |             |
| $\emptyset$                                                                                              | $\emptyset$ | $\emptyset$     |                           |   |   |   |   |                                                                                                                                                    |   |             |   |   |             |   |   |                                                                                                                                                                                                                                        |             |             |             |             |             |             |
| $\emptyset$                                                                                              | $\emptyset$ | $\emptyset$     |                           |   |   |   |   |                                                                                                                                                    |   |             |   |   |             |   |   |                                                                                                                                                                                                                                        |             |             |             |             |             |             |
|                                                                                                          |             | (Antihomophony) | (Paradigmatic Uniformity) |   |   |   |   |                                                                                                                                                    |   |             |   |   |             |   |   |                                                                                                                                                                                                                                        |             |             |             |             |             |             |

One immediate question arises. Since both of the paradigms have identical violation profiles of the antihomophony constraint, why is Paradigm  $Q$  (e.g. the expected Centrifugal Declaratives in (4)) absent, instead of Paradigm  $P$  (e.g. Perfective Declaratives in (3))? Before turning to answer this question, however, we have to deal with a more fundamental issue, i.e. assuming the cells WXYZ in  $Q$  are phonologically well-formed, why can't an inflectional paradigm contain

*some* holes filled by periphrasis? Furthermore, if an inflectional paradigm must have synthetic forms only, presumably due to some version of paradigmatic uniformity, it remains unclear as to how all of the holes in a paradigm could be converted into periphrasis. The following sections thus aim at resolving these puzzles.

### 3.1. How to express synthetic forms periphrastically

To understand what “ $\emptyset$ ” refers to, one comparable case is the null parse. In OT, the null parse can be defined as i) a candidate in which no phonological structure is parsed or ii) a candidate in which no morphological content is parsed (Prince and Smolensky 2004; see McCarthy and Wolf 2005 for extensive discussion). However, it is obvious that  $\emptyset$  is substantially distinct from the null parse. On the one hand,  $\emptyset$  is filled by periphrasis in the output, which is apparently not the case for the null parse. On the other hand, it is not possible for the null parse to act as an attractor of paradigmatic leveling. The reason is simple. According to McCarthy and Wolf’s (2005) formulation, the null parse (=their null output) has no morphological and phonological structures in the output. It turns out that paradigmatic leveling cannot be motivated accordingly because the null parse does not consist of any covert entity, let alone overt element. Nonetheless, our discussion does have a desirable prediction. Paradigmatic gaps are not supposed to annihilate the entire paradigm, i.e. defectiveness occurs only in some cells of a paradigm. To the best of my knowledge, this generalization seems to be crosslinguistically valid.

A more viable solution is that the morphological content is parsed analytically. For a better understanding, the core idea is schematized in (10). Provided that realizing the centrifugal morpheme incurs a fatal violation of the antihomophony constraint, the grammar resorts to parse [CENTRIFUGAL] onto semantically equivalent hosts such as verb, as indicated by the solid arrow. Here the symbol [ $\approx$ Centrifugal] is used to indicate that [CENTRIFUGAL] is conveyed by the verb. Furthermore, the insertion of the aspectual morpheme, indicated by the dashed arrow, takes place because aspectual or directional marking is obligatory in Declaratives.

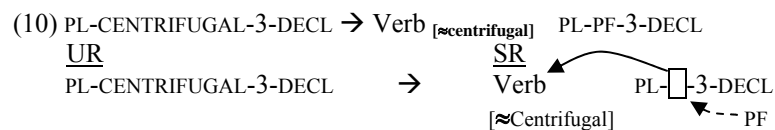

A real example is repeated as follows (=5b).

- (11)  $\text{fánt}^{\text{h}}\text{e}$        $\text{jòŋ}$        $\text{wà}$        $\text{màt}$       **masai**  
 they      all      return<sub>[approx Centrifugal]</sub>      PRT<sub>SELF-COMPLETION</sub>      PL.PF.3.DECL  
 ‘They all returned (home).’ (D&X 1992, p. 139)

### 3.2. Why synthetic and periphrastic forms do not coexist

With the foregoing discussion in mind, let us now turn to explicate why synthetic and periphrastic cells cannot coexist in the same paradigm. To begin with our analysis, two morpheme realization constraints are introduced. Regarding the morpheme realization constraint, it is not possible to explore a myriad theoretical and technical issues here (for an overview, see Wolf 2006).

(12) REALIZE- $\{\text{ASPECT/DIRECTION}\}$  (RLZ- $\{\text{ASP/DIR}\}$ )

‘The aspectual/directional morphemes have an overt output correspondent.’

The constraint in (12) is violated if no entities that convey aspectuality or directionality are present in the output. Notice that periphrasis is not penalized by (12) because the presence of semantically equivalent elements counts as an overt output correspondent. Another essential ingredient in our analysis, the antihomophony constraint, is defined as follows (cf. Crosswhite’s 1999 ANTI-IDENT, Kenstowicz’s 2005 PARADIGM CONTRAST, among many others).

(13) ANTI-HOMOPHONY (ANTI-HOMO)

‘For all  $\alpha, \beta \in P$ , if  $\neg(\alpha = \beta)$ , then there exists some  $\gamma \in \alpha$  s.t.  $\neg(\gamma = f(\alpha, \beta)(\gamma))$ ’ (Where  $f(\alpha, \beta)$  is a function which maps the  $n^{\text{th}}$  segment and tone of  $\alpha$  onto the  $n^{\text{th}}$  segment and tone of  $\beta$ .)

Simply put, (13) means: two segmentally *and* suprasegmentally indistinct Functional Complexes are disallowed. The following tableau shows why Centrifugal Declaratives are absent. First, if underlying morphemes are realized (i.e. for the present purpose, having an output correspondent), homophonous forms occur. This is the case in (14c), the homophonous forms being boldfaced. In order to satisfy ANTI-HOMO, (14b) chooses not to realize the entire paradigm, resulting in multiple violations of RLZ- $\{\text{DIR}\}$ . Therefore (14a) is selected as the winning candidate. Recall the discussion in (10). ANTI-HOMO is not violated in (14a-B) because these forms are [PERFECTIVE].

(14) Homophony avoidance (Where CTFL=Centrifugal;  $\emptyset$ =null parse)

| A: Perfective Declaratives (see (8a))<br>B: Centrifugal Declaratives (see (8b))                                                                                 | ANTI-HOMO | RLZ- $\{\text{DIR}\}$ |
|-----------------------------------------------------------------------------------------------------------------------------------------------------------------|-----------|-----------------------|
| $\text{a. } \{\text{saŋai, sintai, sai, sáká?ai, masintai, masai}\}_A$<br>Verb $_{[\text{CTFL}]}$ + $\{\text{saŋai, sintai, sai, sáká?ai, masintai, masai}\}_B$ |           |                       |
| b. $\{\text{saŋai, sintai, sai, sáká?ai, masintai, masai}\}_A$<br>$\{\emptyset, \emptyset, \emptyset, \emptyset, \emptyset, \emptyset\}_B$                      |           | ***<br>***!           |
| c. $\{\text{saŋai, sintai, sai, sáká?ai, masintai, masai}\}_A$<br>$\{\text{siŋŋai, sintai, sà?ai, sàkà?ai, masintai, màsà?ai}\}_B$                              | *!*       |                       |

Another serious candidate is not taken into consideration. The antihomophony constraint can also be satisfied if the boldfaced forms in (14c-B) are filled by periphrasis. It is conceivable that too many distinct correspondents will be created. This option is penalized by McCarthy's (2005) Optimal Paradigms. OP- $\{\text{DIR(ECTI)ON}\}$  dictates that the exponents of  $[\text{CENTRIFUGAL}]$  must be phonetically indistinguishable within a paradigm. Consider now (15). Notice again that ANTI-HOMO is not violated in (15a-B) because these forms are  $[\text{PERFECTIVE}]$ .

(15) OP- $\{\text{DIR}\}$ : Why synthetic and periphrastic forms cannot coexist

| A: Perfective Declaratives (see (8a))<br>B: Centrifugal Declaratives (see (8b))                                                                                     | ANTI-HOMO | OP- $\{\text{DIR}\}$ |
|---------------------------------------------------------------------------------------------------------------------------------------------------------------------|-----------|----------------------|
| ☞ a. $\{\text{saŋai, sintai, sai, sáká?ai, masintai, masai}\}_A$<br>$\text{Verb}_{[\approx\text{CTFL}]}^+\{\text{saŋai, sintai, sai, sáká?ai, masintai, masai}\}_B$ |           |                      |
| b. $\{\text{saŋai, sintai, sai, sáká?ai, masintai, masai}\}_A$<br>$\{\text{siŋŋai, X, sà?ai, sákà?ai, X, màsà?ai}\}_B$                                              |           | 15*!                 |

(Where  $X = \text{Verb}_{[\approx\text{Centrifugal}]}^+\{\text{sintai/masintai}\}_{\text{PERFECTIVE}}$ ; CTFL=Centrifugal)

For clarity, the output correspondents of the centrifugal morpheme (underlined) are listed as follows.

(16) Exponents of  $[\text{CENTRIFUGAL}]$  in (16b-B): s, sà, and verb  $[\approx\text{Centrifugal}]$

a. siŋŋai ( $\phi$ -sà-iŋ-ai)

SG-CTFL-1-DECL

b. sà?ai ( $\phi$ -sà-à?-ai), sákà?ai (sà-kà?-ai), màsà?ai (ma-sà-à?-ai)

SG-CTFL-3-DECL CTFL-1PL-DECL PL-CTFL-3-DECL

c. Verb $[\approx\text{CTFL}]^+$ **sintai** ( $\phi$ -sà-in-ai), Verb $[\approx\text{CTFL}]^+$ **masintai** (ma-sà-in-ai)

SG-PF-2-DECL PL-PF-2-DECL

Now it should be evident that periphrastic forms in (16c) introduces an additional exponent of  $[\text{CENTRIFUGAL}]$  in the candidate paradigm. This move incurs 15 violations of OP- $\{\text{DIR}\}$ . Hence candidate (15b) is ruled out.

In sum, we have seen that synthetic and periphrastic forms are disallowed to coexist because exponents of a morphosyntactic feature are required to be as few as possible within a single paradigm.

### 3.3. One cell, one vote!

The next issue I would like to address is the following. As mentioned earlier, if the violation profiles of ANTI-HOMO are identical, there is no reason why only aspectual morphemes are retained, but not directional morphemes. A common response is simply to rank RLZ- $\{\text{ASP}\}$  over RLZ- $\{\text{DIR}\}$ . Here I would like to take a step further, exploring what motivates this ranking. This is not a trivial question because the present ranking amounts to expressing the preference of

aspectual marking over directional marking is a pedantic way. A more severe problem is that, according to the morpheme realization constraint defined in (12), the aspectual paradigm may be wiped out and supplanted with the directionals.

(17) Getting tied up

| A: Perfective Declaratives (see (8a))<br>B: Centrifugal Declaratives (see (8b))                                                                                | RLZ-<br>{ASP} | RLZ-<br>{DIR} |
|----------------------------------------------------------------------------------------------------------------------------------------------------------------|---------------|---------------|
| a. {saŋai, sintai, sai, sáká?ai, masintai, masai} <sub>A</sub><br>Verb <sub>[≈CTFL]</sub> +{saŋai, sintai, sai, sáká?ai, masintai, masai} <sub>B</sub>         |               |               |
| b. Verb <sub>[≈PF]</sub> +{siŋŋai, sintai, sà?ai, sákà?ai, masintai, màsà?ai} <sub>A</sub><br>{siŋŋai, sintai, sà?ai, sákà?ai, masintai, màsà?ai} <sub>B</sub> |               |               |
| c. {saŋai, sintai, sai, sáká?ai, masintai, masai} <sub>A</sub><br>{⊙, ⊙, ⊙, ⊙, ⊙, ⊙} <sub>B</sub>                                                              |               | ***<br>***!   |

As shown, the present analysis runs into problems with (17). We know that candidate (17a) is the expected winner. However, an alternative to avoid homophony is given in (17b). That is, [PERFECTIVE] can be conveyed by a verb, a temporal adverb, or the like (represented with [≈PF]). Given that periphrasis does not violate RLZ-{ASP} or RLZ-{DIR}, the current ranking is unable to determine the winning candidate. It turns out that the key difference between the aspectual and directional paradigms lies in the fact that the aspectual paradigms are “larger.” So far, the demonstration of the Functional Complex is limited to the person morphemes used in subject agreement. In actuality, there are two additional types of agreement, namely, antisubject and possessive agreement (Mei 1996). Directional marking occurs in subject agreement only, whereas aspectual morphemes are compatible with all three types of agreement. The number of paradigm members is given in parentheses.

(18) Directional forms are outnumbered

| <i><b>Declaratives</b></i>                                                                                       |                                                     |
|------------------------------------------------------------------------------------------------------------------|-----------------------------------------------------|
| <p><b>Imperfective</b><br/>Subject agreement (6)<br/>Antisubject agreement (10)<br/>Possessive agreement (6)</p> | <p><b>Centripetal</b><br/>Subject agreement (6)</p> |
| <p><b>Perfective</b><br/>Subject agreement (6)<br/>Antisubject agreement (10)<br/>Possessive agreement (6)</p>   | <p><b>Centrifugal</b><br/>Subject agreement (6)</p> |

Let us take Perfective Declaratives for example. First note that this paradigm contains three subparadigms. It turns out that if the whole subject agreement perfect declarative subparadigm is transformed into periphrasis, under the pressure of uniform exponence, the other subparadigms (i.e. antisubject and possessive agreement) will be leveled out as well. The result is that 22 periphrastic forms will be created. By contrast, Centrifugal Declaratives have only one subparadigm. At this point, Kiparsky's (2005) ECONOMY 'Avoid complexity' is able to decide the optimal output, i.e. (17a). More precisely, generating more periphrastic forms means that more morphemes are used: as discussed in (10), the aspectual morphemes are inserted in the periphrastic centrifugal paradigms. If complexity is measured by the number of morphemes, it is then expected that aspectual paradigms are more favorable in the output because failure to realize them in synthetic forms incurs more violations of ECONOMY. Of course, the analysis is based on the assumption that ECONOMY outranks RLZ- $\{ASP\}$  and RLZ- $\{DIR\}$ .

Finally, the current analysis also predicts that homophony is tolerated within a single (sub)paradigm (this may also be construed as syncretism). Details aside, the first and third person imperfect interrogative forms are phonetically indistinguishable, *à thî*. Ranking RLZ- $\{ASP\}$  over ANTI-HOMO explains why homophonous forms are permitted for the case at hand, because they are affiliated with the same subparadigm.

As a brief recap of the foregoing analysis, the ranking of the relevant constraints is given as follows.

(19) ECONOMY » RLZ- $\{ASP\}$  » ANTI-HOMO // OP- $\{DIR\}$  » RLZ- $\{DIR\}$ .

A centrifugal paradigm can be wiped out because ANTI-HOMO and OP- $\{DIR\}$  outranks RLZ- $\{DIR\}$ . Conversely, an aspectual paradigm will not be transformed into periphrasis as RLZ- $\{ASP\}$  dominates ANTI-HOMO. The reason why an aspectual paradigm, but not a directional paradigm, must be realized synthetically is due to the partial ranking RLZ- $\{ASP\}$  » RLZ- $\{DIR\}$ . This ranking relationship is motivated by the fact that aspectual paradigms have more members, with the involvement of the top-ranked ECONOMY constraint.

#### 4. Conclusion

This paper begins with the "missing paradigms" puzzle. Under scrutiny, it reveals that some defective cells serve as the attractor of paradigmatic leveling. I have also shown that homophony avoidance provides a straightforward account for the observed defectiveness. More importantly, paradigmatic uniformity and the interplay of ECONOMY and the morpheme realization constraints (i.e. RLZ- $\{ASP\}$  and RLZ- $\{DIR\}$ ) clearly show that paradigm membership is the key to

understand the tantalizingly intricate morphophonology of the Jinghpo Functional Complex.

## Notes

<sup>1</sup> In the Jinghpo literature, the Functional Complex is known as “Sentence-final Words,” or *Juweici*. The Functional Complex can be further decomposed into the Inflectional Complex (i.e. the clustering of the Number/Aspect/Direction/Person morphemes) and the Mood Expressives (Mei 1996). But this will not concern us here.

<sup>2</sup> The abbreviations and notations used throughout: acute accent = high tone, unmarked = mid tone, grave accent = low falling tone, caret = high falling tone, EMPH = emphatic, INCHO = inchoative, PRT= particle, OBJ = object marker, SG = singular, PL = plural, PF = perfective, IMPF = imperfective, 1, 2, 3 = first, second, third person, DECL = declarative, INTERROG = interrogative, INFER = inferential, EXCL= exclamative, IMP = imperative, JUSS = jussive.

<sup>3</sup> *kàʔ* is a portmanteau morpheme that encodes “first person plural.”

## References

- Albright, Adam. 2003. ‘A quantitative study of Spanish paradigm gaps’, *Proceeding of 22<sup>nd</sup> West Coast Conference of Formal Linguistics*: 1-14.
- Anand, Pranav and Feng-fan Hsieh. 2005. ‘Long distance reflexives in perspectives’, *Proceedings of the 24<sup>th</sup> West Coast Conference of Formal Linguistics*: 43-51.
- Crosswhite, Katherine. 1999. ‘Inter-paradigmatic homophony avoidance in two dialects of Slavic’, *UCLA Working Papers in Linguistics 1. Papers in Phonology 2*: 48-67.
- Dai, Qingxia and Xijian Xu. 1992. *Jingpoyu Yufa (The Grammar of Kachin)*. Beijing: CNU Press.
- Garrett, Edward. 2001. *Evidentiality and Assertion in Tibetan*. UCLA Ph.D. dissertation.
- Kenstowicz, Michael. 2005. Paradigmatic uniformity and contrast. *Paradigms in Phonological Theory*, Downing et al (ed.), OUP: 145-169.
- Kiparsky, Paul. 2005. Blocking and periphrasis in inflectional paradigm. *Yearbook of Morphology 2004*: 113-135.
- McCarthy, John. 2005. Optimal paradigms. *Paradigms in Phonological Theory*, Downing et al (ed.), OUP: 170-210.
- McCarthy, John and Matt Wolf. 2005. Less than zero: Correspondence and the null output. ROA-722.
- Mei, Kuang. 1996. *Jingpoyu de Juweici (Sentence-final words in Jinghpo)*. Ms., National Tsing Hua University.
- Prince, Alan and Paul Smolensky. 2004. *Optimality Theory: Constraint Interaction in Generative Grammar*. Malden, MA: Blackwell Publishing.
- Wolf, Matt. 2006. For an autosegmental theory of mutation. ROA-754.

Feng-fan Hsieh  
Massachusetts Institute of Technology  
77 Massachusetts Avenue, 32-D970A, Cambridge, MA 02139  
ffhsieh@mit.edu

# Direct Complement Clauses as Object Control Structures in Turkish

**Atakan Ince**

University of Maryland  
College Park

## 1. Direct Complement Clauses in Turkish

One property of ‘V+ASP/TNS+AGR’-type Direct Complement Clauses (DCC) in Turkish is that the subject DP can optionally bear Accusative Case as well as Nominative Case, as in (1).

1. Ahmet-Ø sen-Ø/i            Ankara-ya    **gittin**    sanıyordu.  
A.-NOM    you-NOM/ACC    A.-DAT    went.2S    assumed.3S  
‘Ahmet assumed that you went to Ankara.’

This paper looks at Turkish ‘V+ASP/TNS+AGR’ type Direct Complement clauses where the embedded subject bears Accusative Case, as in (2).

2. Ahmet-Ø sen-i            Ankara-ya    **gittin**    sanıyordu.  
A.-NOM    you-ACC    A.-DAT    went-2S    assumed.3S  
‘Ahmet assumed that you went to Ankara.’

I argue that these ‘V+ASP/TNS+AGR’-type structures are, in fact, not ECM structures (Aygen (2002), Özsoy (2001), Zidani-Eroğlu (1997), among others), but **object control** structures.



## 2. Evidence that the Accusative Subject is in the Matrix Clause

We begin by looking at evidence from ‘matrix clause’-modifying adverbs (2.1.), scrambling (2.2.), the phrasal category of DCCs (2.3.), specificity-Accusative Case correlation (2.4.), the Anti-Clause-mateness Condition (2.5.), ‘embedded clause’-modifying adverbs (2.6.) and gapping (2.7.).

### 2.1. Accusative Subject Precedes a Matrix Clause Adverb

As Postal (1974) observed for English, an unambiguous adverb modifying the matrix clause can follow an Accusative subject linearly. The NPI adverb *asla* ‘never’ can only appear in a clause where the verb is negated; thus, in (3), the adverb must be in the negated matrix clause. In (4), *halbuki* ‘actually’ can only have a matrix clause interpretation. If the Accusative subject in these sentences were in the embedded clause, the adverb following it would also be in the embedded clause and could not be interpreted in the matrix clause, contrary to what we see here.

3. Meral-Ø biz-i asla sinema-ya gidiyoruz sanmazdı.  
M.-NOM we-ACC never cinema-DAT going.1P not assumed.3S  
‘Never did Meral think that we went to the movies.’
4. Ahmet-Ø biz-i halbuki sinema-ya gidiyoruz sanıyordu.  
A.-NOM we-ACC actually cinema-DAT going-1P assumed-3S  
‘Actually, Ahmet thought that we were going to the movies.’  
\*Ahmet thought we were actually going to the movies.’

On the other hand, there is evidence that Nominative subjects and Accusative subjects of embedded clauses are in different positions. As demonstrated in (5), when the same adverbs of examples (3-4) follow an embedded Nominative subject, the result is ungrammatical. This suggests that only Nominative subjects are in the embedded clause.

5. \*Meral-Ø biz-Ø asla/halbuki sinema-ya gidiyoruz sanmazdı.  
M.-NOM we-NOM never/actually cinema-DAT going-1P not.assumed.3S  
Intended: ‘Never did Meral think that we went to the movies.’  
Intended: ‘Actually, Meral wouldn’t think that we went to the movies.’

## 2.2. Scrambling Asymmetry

The sentence in (6) has unmarked word order. The examples in (7), derived from (6), demonstrate that Turkish allows rightward-scrambling of phrases.

6. Ahmet-Ø Ayşe-ye kitabı verdi.  
 A.-NOM A.-DAT book-ACC gave-3S  
 ‘Ahmet gave Ayşe the book.’
7. a.  $t_1$  Ayşe-ye kitabı verdi Ahmet-Ø<sub>1</sub>.  
 A.-DAT book-ACC gave-3S A.-NOM  
 b. Ahmet-Ø  $t_2$  kitabı verdi Ayşe-ye<sub>2</sub>.  
 A.-NOM book-ACC gave-3S A.-DAT  
 c. Ahmet-Ø Ayşe-ye  $t_3$  verdi kitab-ı<sub>3</sub>.  
 A.-NOM A.-DAT gave-3S book-ACC

Turkish does not permit scrambling of any element out of embedded finite clauses to the right periphery of matrix clauses. Taking the unmarked sentence in (8), we see in (9) (from George & Kornfilt (1981: 120)) and (10) that neither the Nominative marked subject nor the object can be scrambled rightward.

8. Dinleyiciler-Ø [biz-Ø viski-yi içtik] sanıyorlar.  
 auditor-NOM we-NOM whisky-ACC drank-1P assumed.3P  
 ‘The auditor believe we drank the whisky.’
9. \*Dinleyici-ler-Ø [  $t_2$  viski-yi içtik] sanıyorlar biz-Ø<sub>2</sub>.  
 auditor-PLU-NOM whisky-ACC drank-1P assuming.1P we-NOM  
 ‘The auditor believe we drank the whisky.’
10. \*Dinleyici-ler-Ø [biz-Ø  $t_2$  içtik] sanıyorlar viski-yi<sub>2</sub>.  
 auditor-PLU-NOM we-NOM drank-1P assuming.3P whisky-ACC  
 ‘The auditor believe we drank the whisky.’

Since the Accusative subject can be scrambled to the right periphery of the matrix clause (11), we can conclude that it must not be in the embedded clause.

11. (?)Hasan-Ø  $t_3$  [Ayşe-den nefret ediyoruz] sanıyor biz-ı<sub>3</sub>.  
 H.-NOM A.-ABL hatred do-1P assuming.3P we-ACC  
 ‘Hasan thinks that we hate Ayşe.’

### 2.3. No Embedded Complementizer in DCC's

Öztürk (2005a) claims that Accusative subjects raise to the Spec position of the embedded C. However, there is no evidence for assuming a C head in finite complement clauses. In fact, there are arguments to the contrary; Aygen (2002) argues that DCC's are AspPs (see also Moore (1998)). Let's look at evidence from the use of the complementizer **diye**. Verbs that take finite clauses as complements require the overt complementizer **diye**, as in (12).

12. Ben-Ø [Ali-Ø Ankara-ya gitti] **\*(diye)**  
 I-NOM A.-NOM A.-DAT go-3S saying  
 duydum / haber aldım / bağırdım . . .  
 heard-1S / news took-1S / yelled-1S  
 'I heard/was notified/yelled that Ali went to Ankara.'

The complementizer **diye** is required irrespective of whether the embedded or matrix clause is negated, as in (13) and (14).

13. Ben-Ø [Ali-Ø Ankara-ya gitmedi] **\*(diye)**  
 I-NOM A.-NOM A.-DAT not.went-3S saying  
 duydum/ söyledim / bağırdım . . .  
 heard-1S / told-1S / yelled-1S  
 'I heard/told/yelled that Ali didn't go to Ankara.'
14. Ben-Ø [Ali-Ø Ankara-ya gitti] **\*(diye)**  
 I-NOM A.-NOM A.-DAT went-3S saying  
 duymadım / söylemedim / bağırmadım . . .  
 not.heard-1S / not.told-1S / not.yelled-1S  
 'I didn't hear/tell/yell that Ali didn't go to Ankara.'

Since verbs that take a CP complement select the overt complementizer **diye**, if DCC's are also CPs, then this complementizer should be grammatical in DCC's. However, as shown in (15), this is not the case, suggesting that DCC's are not CPs.

15. Ahmet-Ø biri-Ø/ni Ankara-ya gitti **\*(diye)** sanıyordu.  
 A.-NOM someone-NOM/ACC A.-DAT went-3S saying assumed.3S  
 'Ahmet assumed that someone went to Ankara.'

### 2.4. Specificity-Accusative Case Correlation

There is also a difference in interpretation between Accusative Subjects and Nominative Subjects. Direct Objects (DO) marked with overt Accusative Case

in Turkish must receive a specific reading (Enç (1991), Cagri (2005), among others). Likewise indefinite Accusative Accusative subjects always receive a specific reading, as in (16b), in contrast to their Nominative equivalents which are non-specific, as in (16a). Thus, the difference between ACC-marked Subjects and NOM-marked Subjects is not limited to Case-marking alone.

16. a. Ahmet-Ø [biri-Ø            Ankara-ya gitti] sanıyordu.  
 A.-NOM someone-NOM A.-DAT went-3S assumed-3S  
 ‘Ahmet believed that someone went to Ankara’ (meaning: ‘*Ahmet believed an event such that someone went to Ankara.*’)
- b. Ahmet-Ø biri-ni            [Ankara-ya gitti] sanıyordu.  
 A.-NOM someone-ACC A.-DAT went-3S thought-3S  
 ‘Ahmet believed that someone went to Ankara.’ (meaning: ‘*Ahmet believed with respect to some (specific) person that he went to Ankara.*’)

Since ACC-marked phrases must have specific readings and non-ACC-marked ones cannot, I assume that ACC-marked Subjects are in the same position as (overtly) ACC-marked DOs, that is, (along the lines of the Minimalist Program), in [SPEC,  $\nu$ P].

Having adopted the position that ACC-marked Subjects are in [SPEC,  $\nu$ P] of the matrix clause, let’s entertain a possible counter-argument. One could say that a non-Accusative subject is also in an object position, but since it does not bear (overt) Accusative Case it lacks a [+specific] reading. This is not possible with [+human] nominals which as objects must always be overtly case-marked. As demonstrated in (17), the [+human] indefinite object *biri(si)* ‘someone’ cannot be bare (see Cagri (2005), and references therein). This is evidence against the idea that the subject of the embedded clause in (16a) *biri* is in the matrix verbal domain.

17. Ahmet-Ø birisi-\*(ni) gördü.  
 A.-NOM one-ACC saw-3S  
 ‘Ahmet saw someone.’

## 2.5. The Anti-Clause-mateness Condition

Turkish has a constraint which I will call the *Anti-Clause-mateness Condition* against two DPs with the same (structural) Case occurring in the same clause (see also Öztürk 2005b). In (18), we see that a sentence where the Nominative Subject of an embedded clause is scrambled to the matrix clause-initial position is ungrammatical.

18. a. \*Ercan<sub>i</sub>-Ø Hasan-Ø [t<sub>i</sub> keki yedi] sanıyor.  
 -NOM -NOM cake ate-3S assuming-3S  
 ‘Hasan thinks Ercan ate the cake.’ (Aygen 2003: 81)
- b. Hasan-Ø [Ercan-Ø kek-i yedi] sanıyor.  
 -NOM -NOM cake-ACC ate-3S assuming-3S  
 ‘Hasan thinks Ercan ate the cake.’

Material between the two DPs does not save the structure, either. In (19), although the scrambled DP is in an A'-position and an adverb occurs between the two Nominative DPs, the structure is still ungrammatical.

19. \*Ercan<sub>i</sub>-Ø dün Hasan-Ø [t<sub>i</sub> kek-i yedi] sanıyordu.  
 -NOM yesterday -NOM cake-ACC ate-3S assumed-3S  
 ‘Hasan yesterday thought that Ercan ate the cake.’

So, in line with the *Anti-Clause-mateness Condition*, one would not expect an Accusative subject to occur with an Accusative object in the same clause. The grammaticality of (20) where an Accusative subject and Accusative object is another argument that the Accusative subject is not in the same clause with the Accusative object.

20. Hasan-Ø Ercan-ı [kek-i yedi] sanıyordu.  
 -NOM -ACC cake-ACC ate-3S assumed-3S  
 ‘Hasan thought that Ercan ate the cake.’

## 2.6. Accusative Subjects and ‘Embedded Clause’-Modifying Adverbs

Furthermore, an Accusative subject cannot occur between an embedded-clause-modifying adverb and an Accusative-marked object, as in shown in (21). As shown in (22), if the Accusative subject precedes the adverb, the structure is good.

21. \*Ben-Ø [yarın Ali-yi balığı yiyecek] sanıyordum.  
 I-NOM tomorrow A.-ACC fish will.eat-3S assumed-3S  
 ‘I thought that Ali will eat the fish tomorrow.’
22. Ben-Ø Ali-yi [yarın balığı yiyecek] sanıyordum.  
 I-NOM A.-ACC tomorrow fish will.eat-3S assumed-3S  
 ‘I thought that Ali will eat the fish tomorrow.’

But, in contrast to (21), the Nominative subject can occur between the embedded adverb and Accusative DO, shown in (23).

23. Ben-Ø [yarın Ali-Ø balığı yiyecek] sanıyordum.  
 I-NOM tomorrow A.-NOM fish will.eat-3S assumed-3S  
 ‘I thought that Ali will eat the fish tomorrow.’

This, again, shows that Accusative subject and Nominative subjects of the embedded clauses are in different positions: Accusative subject is in the matrix clause, whereas Nominative subject is in the embedded clause.

## 2.7. Gapping

Turkish does not allow gapping of phrases in different clauses, as shown in (24).

24. Ali-Ø [Ahmet-in Ankara-ya gittiği]-ni sanıyor,  
 A.-NOM A.-GEN A.-DAT went-ACC assuming-3S  
 \*Mehmet-Ø de Özgür-ün.  
 M.-NOM also Ö.-GEN  
 ‘Ali thinks that Ahmet went to Ankara, and \*Mehmet Özgür.’

However, an Accusative subject can be gapped with a phrase from the matrix clause, as in (25). This further supports the view that the that an ACC-marked Subject is in the matrix clause.

25. Ali-Ø Ahmet-i [Ankara-ya gitti] sanıyor,  
 A.-NOM A.-ACC A.-DAT went-3S assuming-3S  
 Mehmet-Ø de Özgür-ü.  
 M.-NOM also Ö.-ACC  
 ‘Ali thinks that Ahmet went to Ankara, and \*Mehmet Özgür.’

## 2.8. Interim Conclusion

So far, we have seen evidence that there are positional and interpretational differences between Accusative and Nominative subjects of embedded clauses. This data is problematic for analyses which suggest that Accusative subjects are in the embedded clause.

### 3. Accusative subjects Merge in the Matrix Clause

Continuing from the interim conclusion above, we can either assume that Accusative subjects raise from the embedded clause to the matrix clause where they check Accusative Case (in [Spec,  $\nu$ P]) (as Moore (1998), Zidani-Eroğlu (1997) and Özsoy (2001), among others argue) or that they are base-generated in the matrix clause. In this section, I present data which shows that not only are Accusative subjects pronounced in the matrix clause but that they are base-generated there as well.

Let's take two Verb + Object type idiom chunks like *birinin defterini dürmek* 'your number is up', in (26), and *birinin anasını bellemek* 'to really mess up someone', in (27). Observe that the object obligatorily bears Accusative Case.

26. *pro* [Hasan-*in* defterin]\*(-*i*) dürdüler.  
 H.-GEN his.notebook-ACC prepared-3P  
 'Hasan's number is up.'

27. Müdür- $\emptyset$  [Ali-nin anasını]\*(-*i*) belledi.  
 manager-NOM A.-GEN his.mother-ACC screwed-3S  
 'The manager really messed up Ali.'

The passive forms of these phrases also give idiomatic readings, as in (28) and (29), showing that idiomaticity is preserved under A-movement.

28. [Hasan-*in* defteri]- $\emptyset$  dürüldü.  
 H.-GEN his.notebook-NOM was.prepared-3S  
 'Hasan's number is up.'

29. [Ali-nin anası]- $\emptyset$  bellendi.  
 A.-GEN his.mother-NOM was.screwed-3S  
 'They really messed up Ali.'

In embedded contexts, the idiomatic reading is again preserved in both active (30a-31a) and passive (30b-31b) forms.

30. a. [[Hasan-*in* defterin]-*i* dürdüler] sanyordum.  
 H.-GEN his.notebook-ACC prepared-3P assumed-1S  
 'I thought that Hasan's number was up.'  
 b. [[Hasan-*in* defteri]- $\emptyset$  dürüldü] sanyordum.  
 H.-GEN his.notebook-NOM was.prepared-3S assumed-3S  
 'I thought that Hasan's number was [caused to be] up.'

31. a. [Müdür-Ø [Ali-nin anasını]-ı belledi] sanıyordum.  
 manager-NOM A.-GEN his.mother-ACC screwed-3S assumed-1S  
 ‘I thought that the manager really messed up Ali.’  
 b. [[Ali-nin anası]-Ø bellendi ] sanıyordum.  
 A.-GEN his.mother-NOM was.screwed-3S assumed-1S  
 ‘I thought that they really messed up Ali.’

Note that the idiom derived subjects ‘Hasan’s notebook’ and ‘Ali’s mother’ in the passives in (30b) and (31b) above bear Nominative Case, indicating that these DPs are in [Spec, TP]. When these DPs keep the Accusative Case in passive form, the idiomatic reading is not available, as in (32) and (33).

32. [Hasan-ın defterin]-i [dürüldü] sanıyordum.  
 H.-GEN his.notebook-ACC was.prepared-3S assumed-1S  
 ‘intended reading = I thought that Hasan’s notebook was closed.’ (idiomatic reading non-available)
33. [Ali-nin anası]-nı [bellendi ] sanıyordum.  
 A.-GEN his.mother-ACC was.screwed-3S assumed-1S  
 ‘I thought that Ali’s mother was raped.’  
 (idiomatic reading non-available)

The non-availability of idiomatic readings with Accusative subjects shows that these subjects are not in the same clausal domain with the embedded verb and further that they do not raise to the matrix clause from within the embedded clause. If they did raise, it would still be A-movement, and we have seen that idiomaticity is preserved under A-movement for these idioms in passive structures in (28-29-30b-31b).

This supports that the Accusative subjects in (32)&(33) are base-generated in the matrix clause.

The loss of idiomatic reading is not due to (Accusative) Case. Non-availability of idiomaticity cannot be due to the definiteness effect on overtly Accusative-marked DPs because in the active voice the object DP always bears Accusative Case in these idioms. In other words, idiomaticity is preserved when a DP has Accusative Case in Turkish: In *birinin defterini dürmek*- (one’s number’s up), the complement *birinin defterini* bears Accusative Case.

In English, for example, idiomaticity is preserved under raising (Postal 1974):

34. a. It seems that the cat is out of the bag.  
 b. The cat seems to be out of the bag.



- c. We expect the cat to be out of the bag well before the date of the party.

#### 4. A New Analysis for Turkish DCC's

In this section, I will argue that 'V + TNS/ASP + AGR' DCC's are **object control** structures.

Takano (2003) argues that Japanese ECM structures are prolepsis structures; i.e., the ACC-marked Subject is base-generated in the matrix clause. Also, there is a *pro* in the embedded clause co-indexed with the proleptic DP.

35. . . . DP<sub>1</sub><sup>ECM</sup> [*pro*<sub>1</sub> . . .] . . .

However, we cannot assume this analysis for Turkish because the Accusative DP in Turkish cannot stand for a complement DP in the embedded clause (38), in contrast to Japanese (37). Takano (2003: 810) notes that the complement of the embedded verb *horeteiru* 'is.in.love' bears Dative Case in matrix clauses (36):

36. Bill-wa Mary-ni/\*o horeteiru.  
*Bill-Top Mary-Dat/Acc is.in.love*  
 Bill is in love with Mary.

The same complement can occur in proleptic position, and bears ACC Case:

37. John-wa Mary-o [Bill-ga horeteiru to] omotteiru.  
*John-Top Mary-Acc Bill-Nom is.in.love that think*  
 John thinks of Mary that Bill is in love with her. (Takano 2003: 810)

However, no complement can occur in the same position in Turkish:

38. \*Ahmet-Ø Ali-yi [Hasan-Ø nefret ediyor] sanıyordu.  
 A.-NOM A.-ACC H.-NOM hatred doing-3S assumed  
 'Ahmet thought that Hasan hated Ali.'

Note that complement of *nefret et-* bears Ablative Case:

39. Hasan-Ø Ali-den/\*-yi nefret ediyor  
 H.-NOM A.-ABL/ACC hatred doing-3S  
 ‘Hasan hates Ali.’

This would be quite mysterious under a prolepsis analysis because Turkish has object *pro* (40) as well as subject *pro* (41):

40. A: Ahmet geldi mi?  
 A.-NOM came-3S Q  
 ‘Did Ahmet come?’  
 B: Evet, *pro* geldi  
 yes came-3S  
 ‘Yes, he came.’
41. A: Ahmet-Ø çikolata-yı yedi mi?  
 A.-NOM chocolate-ACC ate-3S Q  
 ‘Did Ahmet eat the chocolate?’  
 B: Evet, *pro*<sub>SUBJ</sub> *pro*<sub>OBJ</sub> yedi  
 yes ate-3S  
 ‘Yes, he ate it.’

So, I do not see any reason for an Accusative DP not to be co-indexed with a non-subject in the embedded clause.

Also, an object *pro* in an embedded clause can be co-indexed with a DP in the matrix clause (42):

42. A: Ali-Ø Ayşe-yi arayacakmış!  
 A.-NOM A.-ACC will.call-3S  
 ‘(Reportedly) Ali will call Ayşe.’
- B: Ahmet-Ø Ayşe<sub>1</sub>-ye [Ali-nin *pro*<sub>1</sub> arayacağı]-nı  
 A.-NOM A.-DAT A.-GEN will.call-3S-ACC  
 zaten söylemişti  
 already had.said-3S  
 ‘Ahmet already told Ayşe Ali was going to call her.’

In (42), *pro* in the embedded clause is co-indexed with *Ayşe* in the matrix clause. Then, there would be no reason for an Accusative DP to be co-indexed with an object *pro* in the DCC.

Therefore, I argue that ‘V + TNS/ASP + AGR’ structures in Turkish are **object control** structures:

43. . . . DP<sub>i</sub> [PRO<sub>i</sub> . . .] . . .

Note that in English idiomatic readings are unavailable in control structures as well.

Thus, we can argue that ‘V + TNS/ASP + AGR’ structures in Turkish are not finite structures. It would be surprising that they are not finite although there is both TNS/ASP and AGR inflection. At this point, I will buy Aygen’s argument that DCC’s have Aspect morphology but not Tense morphology. This shows that Tense is a key factor that determines finiteness in Turkish. I will not go into the discussion whether only Tense or Tense and Mood determines finiteness in Turkish.

## 5. DCC Verbs

I suggest that Accusative subjects merge in SPEC, V in the matrix clause, and the embedded clause merges as complement to the matrix V (See also Takano (2003)). PRO is in the subject position of the embedded clause, which is licensed with the Accusative subject.

44.  $[_{VP} DP_1 [_{V'} [_{Clause} PRO_1 \dots] V^o ]]$

Having merged in SPEC, V, the DP raises to SPEC, *v* to check Accusative Case.

45.  $[_{VP} DP_1 [_{v'} [_{VP} t_1 [_{V'} [_{Clause} PRO_1 \dots] V^o ]] v^o ]]$

By extension, some psych-verbs in Turkish have two different subcategorization patterns. They can take one complement (46a), or two complements (46b):

46. a.  $[_{VP} [_{V'} \text{Complement} V^o ]]$   
 b.  $[_{VP} \text{Complement}_1 [_{V'} \text{Complement}_2 V^o ]]$

## References

- Aissen, Judith L. 1974. “Verb raising”. *Linguistic Inquiry* 5: 325-366.  
 Aygen, Gülşat. 2002. *Finiteness, Case and Clausal Architecture*. Unpublished Ph.D. Thesis. Harvard University.

- Aygen, Gülşat. 2003. "Extractibility and the nominative case feature on tense". Özsoy, A. S., D. Akar, M. Nakipoglu-Demiralp, E.E. Taylan, and A. Koc, eds., 81-94. *Studies in Turkish Linguistics*. Istanbul: Bogazici University Press.
- Brendemoen, Bernt & Eva A. Csató. 1986. "The head of S in Turkish: A comparative approach to Turkish syntax". In Ayhan Aksu-Koç & Eser Erguvanli-Taylan (eds.), *Proceedings of the Turkish Linguistics Conference*, Boğaziçi University Publications, Istanbul, pp. 85-100.
- Davies, William D. 2005. "Madurese Prolepsis and its Implications for a Typology of Raising". *Language* 81.3: 645-665.
- George, Leland M. & J. Kornfilt. 1981. "Finiteness and boundedness in Turkish". In Frank Heny (ed.), *Binding and Filtering*, MIT Press, Cambridge, MA: 105-127.
- Kornfilt, Jaklin. 1977. "A note on Subject raising". *Linguistic Inquiry* 8: 736-742.
- Landau, Idan. 2004. "The Scale of Finiteness and the Calculus of Control". *Natural Language and Linguistic Theory* 22: 811-877.
- Lasnik, Howard. 2001. "Subjects, Objects, and the EPP". In Davies, W.D. & S. Dubinsky (eds.), *Objects and Other Subjects*, 103-121, Kluwer Academic Publishers, Dordrecht, Boston, London.
- Moore, John. 1998. "Turkish Copy-Raising and A-Chain Locality". *Natural Language and Linguistic Theory*, 16: 149-189.
- Özsoy, A. S. 2001. "On Small Clauses, Other Bare Verbal Complements and Feature Checking in Turkish". In E. Erguvanli-Taylan (eds.), *The Verb in Turkish*. Amsterdam: John Benjamins Publishing Company, 213-237.
- Öztürk, Balkız (2005a). Accusative Subjects in Turkish. Handout. Mediterranean Syntax Meeting, Rhodes, Greece.
- Öztürk, Balkız. 2005b. *Case, Referentiality and Phrase Structure*. Amsterdam, Philadelphia: John Benjamins Publishing Company.
- Postal, Paul M. 1974. *On raising: One rule of English grammar and its theoretical implications*. Cambridge, MA: MIT Press.
- Postdam, E. & J. Runner. 2001. "Richard returns: Copy Raising and its implications". *Chicago Linguistic Society* 37: 453-468.
- Pullum, Geoffrey K. 1975. "On a non-argument for the cycle in Turkish". *Linguistic Inquiry* 6: 494-501.
- Rizzi, Luigi. 1990. "On the anaphor-agreement effect". *Rivista di Linguistica* 2:27-42.
- Takano, Yuji. 2003. "Nominative Objects in Japanese Complex Predicate Constructions: A Prolepsis Analysis". *Journal of East Asian Linguistics* 21: 779-834.
- Woolford, Ellen. 1999. "More on the anaphor agreement effect". *Linguistic Inquiry* 30.2: 257-287.

Zidani-Eroğlu, L. 1997. "Exceptionally Case Marked NPs as Matrix Objects."  
*Linguistic Inquiry* 28.2: 219-230.

*Atakan Ince*  
*Dept of Linguistics*  
*1401 Marie Mount Hall*  
*University of Maryland*  
*College Park, MD 20742*  
*atakan@umd.edu*

# Why-in-Situ: Three Overt Syntactic Positions in Thai

**Jirapat Jangjamras**

Program in Linguistics, University of Florida

Wh-phrase *thammai* ‘why’ in Thai can occur in the three overt syntactic positions: clause-initially, clause-internally and clause-finally. I propose that there are two positions in Thai syntax for ‘why’ to merge. Following Ko’s (2005) CP- Modifier Hypothesis for wh-in situ languages, the first position is [Spec, CP]. The other position for *thammai* is VP adjunction. Empirical evidence from intervention effects and theoretical considerations supports the need for two positions. If this conclusion is correct, it indicates that the CP-Modifier Hypothesis is not universal.

## 1 Puzzling Data

In Thai, the wh-phrase *thammai* ‘why’ can occur in three overt syntactic positions in a sentence. These positions are clause-initially or [‘why’ SUBJ VP] as in (1a), clause-internally or [SUBJ ‘why’ VP] as in (1b), and clause-finally or [SUBJ VP ‘why’] as in (1c).

- (1) a. clause initially  
       *thammai*    *pranii*        *kin*        *din*  
       why        Pranee        eat        soil
- b. clause internally  
       *Pranii*        *thammai*        *kin*        *din*  
       *Pranee*        why        eat        soil
- c. clause finally  
       *Pranii*        *kin*        *din*        *thammai*  
       *Pranee*        eat        soil        why  
       “Why did/does Pranee eat soil?”

Despite the difference in positions of *thammai* in a clause, all of these sentences have the same meaning. The goal of this paper is to provide a syntactic analysis of this fact. Section 2 provides some background information on Thai syntax. In section 3, I show how Ko’s (2005) CP-Modifier Hypothesis can account for (1a) and (1b) by base-generating *thammai* in [spec, CP]. In section 4, I consider two analyses of (1c), one of which is based on Ko’s proposal and another which is a VP adjunction hypothesis. I conclude that (1c) cannot be accounted for with the CP Modifier Hypothesis, but it can be accounted for with VP adjunction.

## 2 Thai Language

Before analyzing the data in detail, I would like to provide some background on Thai. Thai belongs to the Tai-Kadai family. This Southeast Asian language is an SVO language with restricted word order (scrambling is not possible). It is a ‘pro-drop’ language as the subject of the sentence, especially in spoken language, is usually dropped when context is sufficient. I propose that Thai is a wh-in-situ language as the wh-phrases ‘who’ and ‘what’ always remain in situ:

- (2) a. khaw kin ʔarai  
       he eat what  
       “What does he eat?”  
       b. \*ʔarai khaw kin  
       what he eat  
       “What does he eat?”
- (3) a. khrai maa  
       who come  
       “Who came?”  
       b. \*maa khrai  
       come who  
       “Who came?”
- (4) a. khun maa kàp khrai  
       you come with who  
       “Who did you come with?”  
       b. \*khrai khun maa kàp  
       who you come with  
       “Who did you come with?”  
       c. \*kàp khrai khun maa  
       with who you come  
       “Who did you come with?”

Like Chinese, Thai is an isolating language with no inflection for tense, number, person and gender. A sentence may be ambiguous if, for example, we have only a bare noun (without classifier or quantifier) or bare verb (without temporal expression). A bare noun can be either singular or plural and a bare verb can refer to either a past or non-past event. Unlike Japanese or Korean, Thai has no overt case markers for arguments such as nominative or accusative or clause type markers such as declarative and interrogative. Thai has no determiners. Thai data presented here is self-generated (or else specified) and has been checked with 10 native speakers<sup>1</sup>.

### 3 Analysis for ‘why’ Clause-Initially and -Internally

To facilitate the discussion, this section is limited to the analysis of the first two overt syntactic positions, namely *thammai* clause-initially and *thammai*-clause internally. For convenience, the relevant data is repeated here.

- (1) a. clause initially: ‘why’ SUBJ VP  
**thammai**      pranii              kin      din  
 why              Pranee              eat      soil
- b. clause internally: ‘why’ SUBJ VP  
 Pranii              **thammai**              kin      din  
 Pranee              why              eat      soil  
 “Why did/does Pranee eat soil?”

Similar variation as in (1a) and (1b) also occurs in ‘why’ clauses in other wh-in situ languages such as Japanese, Korean and Chinese:

- (5) Japanese  
 a. Taroo-sika **naze** sono hon-o      yoma-nakat-ta no?  
 Taroo-only why that book-ACC read-not-past Q  
 Why did only Taroo read that book?  
 b. **Naze** Taroo-sika sono hon-o yoma-nakat-ta no?  
 (from Kuwabara 1998 in Ko 2005: 872)
- (6) Korean  
 a. {Amwuto/?John-pakkey} **way** ku chayk-ul      ilk-ci-anh-ass-ni?  
 Anyone/ John-only      why that book-ACC read-CI-not-Past-Q  
 “Why did {no one/only John} read that book?”  
 b. **Way** {amwuto/John-pakkey} ku chayk-ul-ilk-ci-anh-ass-ni?  
 (Ko 2005: 872)

#### 3.1 CP-modifier hypothesis

For the above variation in Korean and Japanese (hence forth K/J), Ko (2005) proposes that ‘why’ is an adverb that is externally merged at [Spec, CP] in both interrogative and declarative clauses. However, a subject may A-bar move over ‘why’ in [Spec, CP] (e.g. via scrambling or topicalization) or be base-generated above it. This proposal is called the CP-Modifier Hypothesis (CMH).

(7) shows that after external merge of *way* ‘why’, *amwuto* ‘anyone’ may scramble over *way* ‘why’ in Korean to generate (6a).



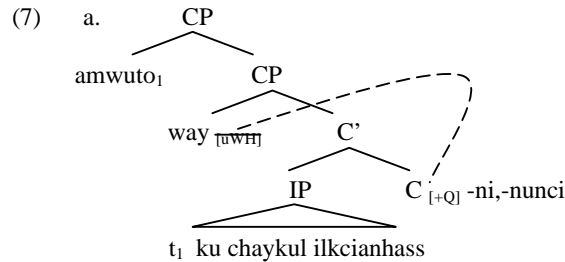

- b. Amwuto **way** ku chayk-ul ilk-ci-anh-ass-ni?  
 Anyone why that book-ACC read-CI-not-Past-Q  
 “Why did no one read that book?” (Ko 2005: 877)

The same analysis can explain the difference between *thammai* clause-initially and *thammai* clause-internally in Thai:

- (1) a. **thammai** Praanii kin din  
 Why Pranee eat soil  
 b. Praanii **thammai** kin din  
 Pranee why eat soil  
 “Why does/did Pranee eat soil?”

In (1a) *thammai* is externally merged into [Spec, CP]. After merging, the DP *Pranee* undergoes topicalization. This results in its clause-initial position in (1b). (8) shows how (1b) is derived from (1a).

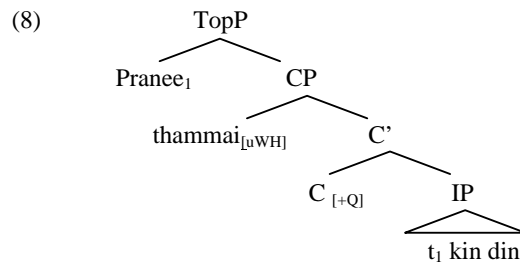

### 3.2 SBEs and movement

There are some restrictions on the elements that can precede ‘why’. In K/J while scope bearing elements<sup>2</sup> (SBEs) such as *amwuto/daremo* ‘any one’ can precede ‘why’ in interrogative clause as in (5) and (6), they cannot in declarative clauses. See (9) for another Korean example.

- (9) \*Amwuto [John-i way saimha-yess-ta-ko] malha-ci-anh-ass-ni?  
 Anyone John-Nom why resign-Past-Dec-C say-CI-not-Past-Q  
 “What is the reason x such that no one said that John resigned  
 for x?” (Ko 2005: 879)

Ko (2005) explains this restriction as an “intervention effect”. “At LF, a wh-phrase cannot be attracted to its checking (scope) position across an SBE” (Ko 2005:271). When ‘why’ is merged in [Spec, CP] in an interrogative clause, it does not need to undergo movement at LF. Thus if the subject is a SBE such as NPI that does not need to undergo LF movement, there is no intervention effect: both word orders NPI ‘why’ and ‘why’ NPI are both fine. However, when ‘why’ must move at LF to take scope out of an embedded clause, an intervention effect arises:

(10) \* [CP [IP NPI... [IP... ‘why’ ...].

In Thai SBEs such as *mâi-mee-khrai* ‘no one’ cannot precede ‘why’, even in interrogative clauses. See (11).

- (11) a. \***mâi-mee-khrai**            **thammai** chôp kin phàk  
no one                                  why like eat vegetables  
“Why does nobody like to eat vegetables?”  
b. **thammai** **mâi-mee-khrai** chôp kin phàk  
why                                  no one                                  like eat vegetables  
“Why does nobody like to eat vegetables?”

Thai is different, thus, from K/J<sup>3</sup>. Similar facts have been documented in *weishenme* ‘why’ clauses in Chinese. Ko (2005) shows that some SBEs in Chinese such as *meiyouren* ‘nobody’, *henshao ren* ‘few people’ and *zhiyou* NP ‘only NP’ cannot precede ‘why’.

- (12) Chinese  
a. \* {Meiyouren/zhiyou Lisi/henshao ren} weishenme cizhi  
b. Weishenme {meiyouren/zhiyou Lisi/henshao ren} cizhi?  
why                                  nobody/                                  only Lisi/ few                                  people resign  
Why did {nobody/ only Lisi/ few people} resign?  
(Ko 2005:883-4)

However, items such as R-expressions and *meigeren* ‘every one’ can precede *weishenme*. To capture this divergent behavior in Chinese, Ko proposes that “an XP may precede *weishenme* only when it may undergo A’ topicalization over [Spec, CP]” (2005: 885).

This claim is appropriate for Thai. A constraint on A-bar movement in Thai explains ungrammaticality of (11a). The examples in (13a,b) show that it is possible to A-bar move an R-expression, but it is not possible to A-bar move an SBE.

- (13) a. Bill nà? (thû) John pût waâ Mary hěn  
Bill Top (that) John said that Mary saw  
Bill<sub>i</sub> John said that Mary saw t<sub>i</sub>.

- b. \*Mǎi-mee-krai nà? (thî) John pûut waâ Mary hěn  
 no one Top that John said that Mary saw  
 No one<sub>1</sub> John said that Mary saw t<sub>1</sub>.

Korean or Japanese equivalents, presented respectively, are grammatical:

- (14) a. Bill-ul John-i Mary-ka bo-atdda malh-atdda  
 Bill-Acc John-Nom Mary-Nom see-Past say-Past  
 Bill<sub>1</sub>, John said that Mary saw t<sub>1</sub>.  
 b. Amuto John-i Mary-ka bogi-moth-atdda malh-atdda  
 Anyone John-Nom Mary-Nom see-Neg-Past say-Past  
 No one<sub>1</sub> John said that Mary saw t<sub>1</sub>.
- (15) a. Biru-ni John-wa Mary-ga atta to itta  
 Billy-ACC John-nom Mary-Nom see that said  
 ‘Bill<sub>1</sub>, John said that Mary saw t<sub>1</sub>.’  
 b. Dare-nimo John-wa Mary-ga awanakatta to itta  
 Who/anyone John-Nom Mary-Nom past-Neg-to-see that said  
 ‘No one<sub>1</sub> John said that Mary saw t<sub>1</sub>.’

The fact that SBEs in Thai cannot be A-bar moved explains why the order SUBJ ‘why’ VP is ungrammatical when SUBJ is SBE.

### 3.3 Pragmatic evidence for topicalization

Pragmatic differences between (1a) and (1b) support the claim that A-bar movement has occurred in (1b). *Thammai* clause-initially (1a) functions mainly as a question because speakers really want to know the reason. In contrast, while (1b) function<sup>4</sup> as a question, the speakers also express surprise. Two Thai speakers<sup>4</sup> reported this subtle difference between (1a) and (1b). They said the speaker of (1b) was surprised by the fact that *Pranee* ate soil, not rice. (8) is repeated here to show (1b).

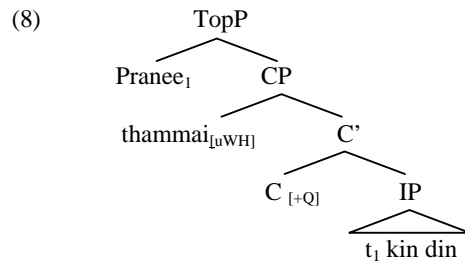

The structure that I propose for (1b) SUBJ ‘why’ VP is similar to topicalization discussed by Rizzi (1997). The topic which normally expresses old information is a preposed element that is set off from the rest of the clause by “comma intonation”(1997: 285). The comment is the rest

of the clause and it introduces new information. Example (16) shows topicalization in English.

- (16) Your book, you should give t to Paul (not to Bill).  
Rizzi (1997: 285)

In (16) the DP *your book* is the topic, old information. The comment is *you should give (your book) to Paul* and it is the new information.

In the Thai sentence (1b) the DP *Pranee* is old information (both interlocutors know her) and it is set off by a pause or comma intonation. The predicate *kin din* ‘ate soil’ is new information that the speakers did not know before. The subject moves to the specifier of a Topic Phrase above IP (Rizzi 1997). This movement is motivated by ‘last resort’ (Chomsky 1993). The subject *DPPranee* A-bar moves across ‘why’ to check [uTOP\*], a strong feature of the Topic phrase. This strong feature can only be checked in a local configuration (Adger 2003). If *DPPranee* remains in [Spec,IP], as in (1a), there is noTopP above CP<sub>[+Q]</sub>.

In addition to a pause, the Top<sup>o</sup> in Thai may be filled by a topic particle *nà?* (Wilawan 2000 calls this particle a ‘topicalizer’). See (17a) and (17b).

- (17) a. C`òd-mǎay (pause)            **thammai** yang mâi maa sàk thii  
letter        topic particle why        yet not arrive once  
“Why hasn’t the letter arrived yet?”  
b. C`òd-mǎay ná?                **thammai** yang mâi maa sàk-thii  
letter        topic particle why        yet not arrive once  
“Why hasn’t the letter arrived yet?”

The example (17a) came from natural speech; the topic particle is a pause. When I asked my interlocutor to repeat what she had just said before, this time she used the overt topic particle *nà?* (17b). This indicates that the two topic particles are interchangeable.

This section argues for the CMH as an explanation for (1a,b). *Thammai* is proposed to be merged at [Spec, CP]. Variation between (1a) and (1b) comes from topicalization. Pragmatic difference supports the existence of a Topic phrase above C, and restriction on A-bar topicalization in Thai is also predicted by CMH.

#### 4 Analysis for ‘why’ Clause-Finally

While the CMH can account for (1a) and (1b) nicely, it does not immediately explain *thammai* clause-finally. This order is not available in Japanese/Korean and was not a concern for Ko. (1c) is repeated here.

- (1) c. Pranii kin din **thammai**  
 Pranee eat soil why  
 “Why did/does Pranee eat soil?”

There are two rival hypotheses to account for *thammai* clause-finally. The first is IP fronting, based on Ko’s CMH, while the second is VP adjunction.

#### 4.1 Hypothesis 1: IP fronting

Under this hypothesis, *thammai* is still merged in [spec, CP]. IP then undergoes A-bar movement to [Spec, TopP]. See (18) below.

The movement is motivated by the same feature checking discussed above for subject topicalization. The strong feature [uTOP\*] needs to be checked locally. The advantage of this hypothesis is that it uses the CMH to account for all positions of *thammai*. . In other words, it provides a uniform analysis of the syntax of *thammai*.

IP Fronting Hypothesis:

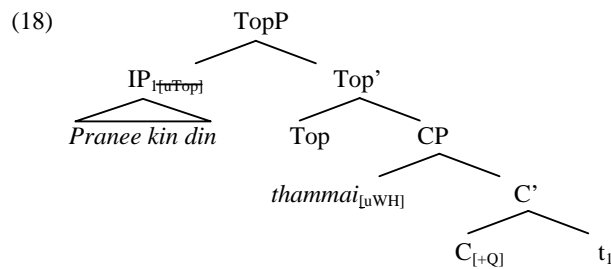

#### 4.2 Hypothesis 2: VP adjunction

Under this hypothesis, *thammai* is right adjoined to VP as shown in (19).

VP Adjunction Hypothesis:

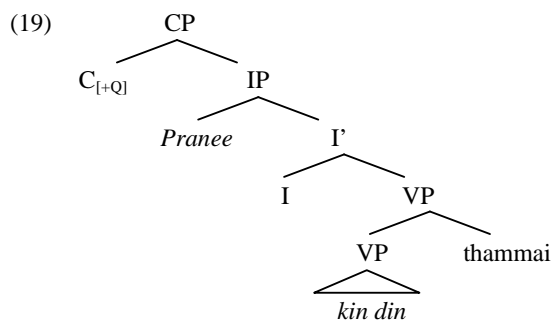

### 4.3 Evaluating the two hypotheses

In this section, I will provide arguments for the VP adjunction hypothesis and point out flaws with the IP fronting hypothesis.

#### 4.3.1 Empirical evidence

Consider the following sentences.

- (20) a. \***mái-mii-khrai** chòp kin phàk **thammai**  
 no one like eat vegetable why  
 “Why does nobody like to eat vegetables?”
- b. **thammai mái-mii-khrai** chòp kin phàk  
 why no one like eat vegetable  
 “Why does nobody like to eat vegetables?”
- (21) a. \***mii-tèe** phᵛᵛ thii ᵛaan nǎng-sᵛᵛ **thammai**  
 only father that read book why  
 “Why does only father read the book?”
- b. **thammai mii-tèe** phᵛᵛ thii ᵛaan nǎng-sᵛᵛ  
 Why only father that read book  
 “Why does only father read the book?”

I observe that *thammai* clause-finally is ungrammatical when the subject is a scope bearing element such as *mái-mii-khrai* ‘no one’ (20a) and *mii-tèe* ‘only’ in (21a). My account for the ungrammatical sentence is adapted from Ko’s intervention effect discussed in section 3.1. Intervention effects result because a wh-phrase cannot be attracted to its checking (scope) position across an SBE.

If VP adjunction is correct, ‘why’ adjoined to VP must undergo LF movement for scope reason. In doing so, it will cross SBE such as *mái-mee-khrai* ‘no one’ and *mii-tèe phᵛᵛ* ‘only father’ in (20) and (21), resulting in an intervention effect. (20a) and (21a) are, thus, correctly predicted to be ungrammatical.

Other elements in Thai such as the emphatic adverb *thᵛᵛᵛ* and negation *mái* appear to be interveners as well.

- (22) a. \*SUBJ NEG VP ‘why’  
 \*thᵛᵛᵛ **mái** chòp kin phàk **thammai**  
 You NEG like eat vegetable why  
 ‘Why don’t you like to eat vegetables?’
- b. ‘why’ SUBJ NEG VP  
**thammai** thᵛᵛᵛ **mái** chòp kin phàk  
 why you NEG like eat vegetable  
 ‘Why don’t you like to eat vegetables?’

- (23) a. \*SUBJ EmpADV VP ‘why’  
 \* \_\_\_\_ **thǎŋ** tham kàp chǎn dâi **thammai**  
 (you) EmpADV do with I can why  
 “Why did you do this to me?”
- b. ‘why’ SUBJ EmpADV VP  
**thammai thǎŋ** tham kàp chǎn dâi  
 why EmpADV do with I can  
 “Why did you do this to me?”

The VP adjunction hypothesis and intervention effects might be appropriate for other wh-adjuncts in Thai. The wh-adjunct *mǎa-rai* ‘when’ also occurs either clause-initially and clause-finally in (24a-b). Similar to *thammai* (1c), ‘when’ clause-finally is ungrammatical when preceded by the adverb *thǎŋ*.

- (24) a. khun cà? tham ɲaan sèt **mǎa-rai**  
 you will do work finish when  
 “When will you finish your work?”
- b. **mǎa-rai** khun cà? tham ɲaan sèt  
 when you will do work finish  
 “When will you finish your work?”
- (25) a. **mǎa-rai** khun **thǎŋ** cà? tham ɲaan sèt  
 when you EmpADV will do work finish  
 “When WILL you finish your work?”
- b. \*/? khun **thǎŋ** cà? tham ɲaan sèt **mǎa-rai**  
 you EmpADV will do work finish when  
 “When WILL you finish your work?”

If we assume IP fronting, (20) – (21) cannot be analyzed as resulting from an intervention effect. *Thammai* is already externally merged at [Spec, CP] where it has scope. Assuming that the features of the SBE are not available at the IP level, no intervention effect is expected under the IP fronting analysis.

#### 4.3.2 Theoretical evidence

A theory-internal argument against IP fronting is available. Abels (2003) proposes that certain heads, including  $C^\circ$ ,  $v^\circ$  and, in most languages,  $P^\circ$  cannot be stranded.

His argumentation against stranding phase heads is developed from Phase Theory (Chomsky 2000). To be licit, movement out of a phase must pass through the specifier position of that phase and only the closer element in a

phase is allowed to move. However, when there are only a head and its complement (which are considered sisters), neither of them is any closer to the higher attractor. As a result, movement from complement to specifier position cannot satisfy the closeness relation. This leads to the ban against stranding phase heads. Since the complement of the phase head can never reach the specifier position in the same phrase, the complements need to stay ‘frozen’ (2003:115) with the phase head.

Abels (2003) argues that it is possible to topicalize CP when it is a complement of a verb such as ‘think’, but TP (his terminology which I refer to as IP in this paper) which is embedded under the complementizer cannot be topicalized. Abels provides Icelandic examples (from Sigurðsson 1996) and English examples.

(26) Icelandic

a. Jón heldur að María sé að lesa.

Jon thinks that María is<sub>SUBJ</sub> to read<sub>INF</sub>  
‘John thinks that María is reading.’

b. ?Að María sé að lesa heldur Jón.

that María is<sub>SUBJ</sub> to read<sub>INF</sub> thinks Jon  
‘That María is reading, John thinks.’

c. \*María sé að lesa heldur Jón að.

María is<sub>SUBJ</sub> to read<sub>INF</sub> believes Jon that

(27) a. Nobody thought anything would happen.

b. That anything would happen, nobody thought.

c. \*Anything would happen, nobody thought that.

(Abels 2003: 10)

These examples reveal that the IP fronting analysis for *thammai* in (1c) is not the correct approach. IP *Pranee kin din* should not be able to strand

$C_{[+Q]}$ .

To conclude this section, a theory-internal explanation for the impossibility of IP fronting (Abels 2003) refutes the IP fronting hypothesis.

In summary, section 4 has proposed that a VP adjunction hypothesis can account for certain ungrammatical sentences as a result of an intervention effect (Ko 2005). The Thai intervener presented here are SBES: *mái-mi-khrai* ‘no one’ and *mii-tèè* ‘only’, negation *mái* and adverbs *thíng*. The IP fronting hypothesis cannot account for the ungrammatical examples and has weak theoretical motivation (Abels 2003). Therefore, the VP adjunction hypothesis emerges as the winning hypothesis accounting for *thammai* clause-finally.



## 5 Conclusion

I have illustrated three overt syntactic positions of *thammai* clauses in Thai. Two of the three positions of ‘why’: clause initially and clause-internally are correctly accounted for by the CMH: ‘why’ is externally merged at [Spec, CP] (Ko 2005). The more problematic pattern is *thammai* clause-finally, which is not available in the languages that Ko analyzes. I proposed two hypotheses to analyze the third position of *thammai*. The first one was to use the CMH and to have IP undergo topicalization over *thammai* in spec,CP. The second hypothesis was to merge ‘why’ through VP adjunction. The VP adjunction hypothesis is the winning hypothesis because it can explain ungrammatical data while IP fronting cannot. In addition, IP fronting is theoretically ruled out.

In Thai, unlike in Japanese and Korean, *thammai* ‘why’ can be either adjoined to VP or merged directly into SpecCP. The two available positions to merge ‘why’ in Thai emphasizes the different structure of ‘why’ vs. other ‘wh-phrases’ that remain in situ. If my conclusion is correct, then it indicates that the CMH is not universal. ‘Why’ can be merged in other positions besides [spec, CP] in wh-in-situ languages, contrary to the CMH.

Future research should investigate the behavior of other wh-adjuncts such as ‘when’, ‘how’ and ‘where’ (Tsai 1994) in Thai. While ‘when’ can occur clause-initially and clause-finally and shows similar intervention effects as ‘why’, ‘how’ and ‘where’ are limited to clause-finally positions only. In general, understanding the mechanism of all wh-phrases in Thai can shed light on the wh-phrases of other wh-in situ languages.

## Notes

\* Special thanks are due to Eric Potsdam for encouragement, comments and proof reading, Brent Henderson for tuning my analysis, and Andrea Dallas for proof reading. At various stages, I benefited from discussions with Youssef Haddad on theoretical issues and Donruethai Laphasradakul, on Thai grammaticality judgments. I am indebted to feedback from WECOL 2006 participants. Thank you very much for your comments and references. I am grateful to all of my language consultants (Thai, Japanese and Korean). Thank you Karen Barto-Sisamout for sharing your term paper discussing that Loa is a wh-in-situ language. A big thank you goes to Pongsak Rattanawong for mentioning the behavior of ‘why’ in Thai.

<sup>1</sup> My language informants include two Thai speakers who live in Thailand and eight Thai speakers who are graduate students at the University of Florida, US.

<sup>2</sup> Scope bearing elements are, for example, *someone*, *only*, *everyone*, *any one* (NPI). Thai has scope bearing elements such as the non-polarity quantifier *mai-mii-khrai* ‘no one/nobody’; however, there is no equivalent to the NPI ‘any one’.

<sup>3</sup> Since Thai does not have clause type markers, the question word ‘why’ counts as the interrogative clause marker. ‘why’ has scope only in the clause it modifies. If ‘why’ only

modifies the embedded clause, this embedded clause is interrogative while the matrix clause is declarative.

<sup>4</sup> These two speakers were interviewed while other Thai speakers completed a written survey on grammaticality judgment.

## References

- Adger, David. 2003. *Core syntax: a minimalist approach*. New York: Oxford University Press.
- Abels, Klaus. 2003. *Successive Cyclicity, Anti-locality, and Adposition Stranding*. Univ. of Connecticut: Ph.D. Diss.
- Chomsky, Noam. 1993. "A minimalist program for linguistic theory", in: Kenneth Hale and Samuel Jay Keyser (eds.), *The View From Building 20*. Cambridge, Mass: MIT Press.
- Chomsky, Noam 2000. "Minimalist inquiries: the framework", in: Roger Martin, David Michaels and Juan Uriagereka (eds), *Step by Step: Essays on minimalism in honor of Howard Lasnik*. Cambridge, MA: MIT Press, 89-155.
- Ko, Heejeong. 2005. "Syntax of why-in-situ: merge into [Spec, CP] in the overt Syntax", *Natural Language & Linguistic Theory* 23. 4: 867-916
- Kobsiriphat, Wissanu. 1988. *Empty Categories in Thai*. Univ. of Washington: Ph.D. Diss.
- Rizzi, Luigi. 1997. "The fine structure of the left periphery", in: Liliane Haegeman (ed.), *Elements of Grammar: Handbook in Generative Syntax*. Dordrecht, Boston, London: Academic Publishers, 281-337.
- Sigurðsson, Halldór Armann. 1996. "Icelandic Finite Verb Agreement", *Working papers in Scandinavian Syntax*. 57:1-46.
- Tsai, Wei-tien Dylan. 1994. "On Nominal Islands and LF Extraction in Chinese", *Natural Language & Linguistic Theory* 12. 1:121-175
- Wilawan. 2000. "Double object construction in Thai revisited", in: Vide P. De Guzman and Byron Bender (eds.), *Grammatical Analysis, Morphology, Syntax, and Semantics: Studies in Honor of Stanley Starosta*. Honolulu, HI: University of Hawai'i Press, 209-223.

*Jirapat Jangjamras*  
*University of Florida*  
*Program in Linguistics*  
 4131 Turlington Hall, Gainesville, FL 32611 USA  
 jirapat@ufl.edu

# Russian Partitive Case and the Quantized/Cumulative Distinction<sup>1</sup>

Susie Jones

University of British Columbia

## 1. Introduction

The Russian partitive case, also called partitive/genitive case, applies to masculine mass NPs. It expresses meanings like “some,” “a bit of,” or “a little.”<sup>2</sup>

| (1) |    | <u>Nominative/Accusative</u> |          | <u>Partitive</u>         |
|-----|----|------------------------------|----------|--------------------------|
|     | a. | chai                         | ‘tea’    | chaiu ‘a little tea’     |
|     | b. | sakhar                       | ‘sugar’  | sakharu ‘a little sugar’ |
|     | c. | pesok                        | ‘sand’   | pesku ‘a little sand’    |
|     | d. | sneg                         | ‘snow’   | snegu ‘a little snow’    |
|     | e. | narod                        | ‘people’ | narodu ‘some people’     |

Examples of sentences with partitive case objects are given in (2):

- (2) a. Ona vypila chai.  
she drink.PAST.PERF. tea.PART.  
She drank a little tea.
- b. On s´el sakharu.  
he eat.PAST.PERF. sugar.PART.  
He ate a little sugar.

In perfective contexts, the meaning of mass NPs with partitive case contrasts with the meaning of mass NPs with accusative case. In (2), the partitive case objects are indefinite, but in (3), the accusative NPs are interpreted as definites:

- (3) a. Ona vypila chai.  
she drink.PAST.PERF. tea.ACC.  
She drank the tea.                      Accusative=definite NP
- b. On s´el sakhar.  
he eat.PAST.PERF. sugar.ACC.  
He ate the sugar.                      Accusative=definite NP

A restriction on the distribution of partitive case, which is explained in section 2, can be attributed to its interpretation as a non-specific indefinite NP. The goal of this paper is to explain, using Krifka's algebraic analysis of aspect (1992), why certain verb forms do not take partitive case objects. Krifka classifies predicates of both objects and events in terms of *cumulativity* and *quantization*. I will argue that verbs which are incompatible with partitive case fall into the category of *cumulative* event predicates.

## 2. A restriction on the distribution of partitive case

Paducheva (1998) discusses a restriction on the distribution of partitive case NPs. Imperfective verbs do not take objects that have partitive case, shown in (4a-b):

- (4) a. \*Ona pila chaiu. \*Imperf., partitive  
 She drink.PAST.IMPERF. tea.PART.
- b. \*On el sakharu. \*Imperf., partitive  
 He eat.PAST.IMPERF. sugar.PART.

Imperfective verbs require their mass term objects to take accusative case:

- (5) a. Ona pila chai. Imperf, accusative ok  
 She drink.PAST.IMPERF. tea.ACC.  
 She drank tea.
- b. On el sakhar. Imperf, accusative ok  
 He eat.PAST-IMPERF. sugar.ACC.  
 He ate sugar.

### 2.1 What accounts for this restriction?

Paducheva (1998) observes that partitive case is sensitive to the difference between perfective and imperfective (grammatical) aspect. In her discussion of the incompatibility of partitive case and imperfectivity, Paducheva hypothesizes:

the semantic obstacle for the use of the partitive with imperfective verbs may lie in the inherent indefiniteness of the Russian partitive ... the partitive is not simply indefinite, but non-specifically indefinite, i.e. non-referential."

However, the generalization that partitive case NPs are non-specific indefinites does not explain why this semantic property should be incompatible with imperfectivity. Moreover, in section 3 I will show that is not only imperfectives that do not take partitive objects, but some perfectives are also incompatible with partitive objects. In section 4, I summarize some of the main claims of Krifka's algebraic account of aspect, which makes possible a unified classification of verbs that do not take partitive case. In Krifka's terms, these verbs denote events that have cumulative predicates. Certain properties of cumulative event predicates explain their incompatibility with partitive NPs in a way that is compatible with Paducheva's observation that partitive case NPs are non-

referential.

### 3 Russian aspect and Vendler classes

Braginsky & Rothstein (2005) discuss whether the Vendlerian classification of verbs into the different lexical categories of states, activities, accomplishments, and achievements (Vendler 1967) is grammatically relevant in Russian, or whether this lexical distinction is subsumed by the perfective/imperfective distinction. The lexical class of a verb reflects semantic properties of the event it denotes. Braginsky & Rothstein define accomplishments as verbs that denote events of change; that is, events that have a natural culmination or endpoint. If such semantic properties are relevant for Russian, “then there should be some linguistic operation which is sensitive to the distinction in lexical class, which provides empirical evidence that lexical classes cut across the perfective/imperfective distinction” (Braginsky & Rothstein, p. 2). Partitive case NPs provide evidence that lexical class distinctions are relevant for Russian. The class of verbs that do not take partitive case includes imperfective accomplishments; however it extends to activities in both their imperfective and perfective forms.

#### 3.1 Partitive case is sensitive to lexical classes

Paducheva (1996) characterizes perfective accomplishment as denoting completed events, and imperfective accomplishments as denoting events in progress. However, she points out that imperfective accomplishments do not correspond to the Vendlerian lexical category of activities (Braginsky & Rothstein : p. 4). The contrast between (6a-b) thus involves a contrast in grammatical aspect, but not lexical aspect. Both verbs are accomplishments, but the contrast is between perfective and imperfective aspect. The imperfective in (6b) is incompatible with partitive case:

- (6) a. Ona vypila chaiu.  
 she drink.PAST.PERF. tea.PART.  
 She drank a little tea. Perf., partitive ok
- b. \*Ona pila chaiu.  
 She drink.PAST.IMPERF. tea.PART. \*Imperf., partitive

Partitive case is also sensitive to the distinction between lexical classes. This is shown in (7a-b). In example (7a), the verb ‘*nesti*’ (to carry) is an imperfective activity, and the sentence is ungrammatical, as expected. In (7b), the same verb is prefixed with ‘*po-*.’ Paducheva (1996) classifies activities prefixed with ‘*po-*’ as ‘delimited activities.’ Braginsky and Rothstein classify delimited activities as perfectives. However, the partitive case NP is ungrammatical in (7b), even though the verb is perfective:

- (7) a. \*On nes pesku.  
 He carry.IMPERF.PAST sand.PART.

- b. \*On pones pesku.  
He carry.PERF.PAST sand.PART.

The prefix ‘*po*,’ when attached to activity verbs, contributes various meanings, such as ‘*for some time*’ (Paducheva 1996) or, with verbs of motion, ‘*for a short distance*’ (Filip 2002). The verb ‘*ponesti*’ roughly means ‘*to set off carrying*’ or ‘*to carry for a short distance*,’ but does not say if the carrying event is ongoing. Because delimited activities do not denote events that involve change, they are classified as activities and not accomplishments (Braginsky & Rothstein).

The sentences in (6b) and (7a-b), which have partitive case objects, are all ungrammatical. The verb in example (6b) differs from the verbs in (7a-b) with respect to lexical aspect: it is an imperfective accomplishment. However, the verb in example (7b) differs from those in (7a) and (6b) with respect to grammatical aspect: it is a perfective. The conclusion to be drawn from these contrasts is that it is insufficient to say that partitive case is incompatible with imperfectives. It is also incompatible with (at least) the lexical class of activities, in both their perfective and imperfective forms. The verbs from examples (7a-b) require mass term objects to take accusative case, shown in (8a-b):

- (8) a. On nes pesok.  
He carry.IMPERF.PAST sand.ACC.  
He carried sand.
- b. On pones pesok.  
He carry.PERF.PAST sand.ACC.  
He carried sand for a little while.

In example (9), ‘*nesti*’ (to carry) is prefixed with ‘*pri*’ instead of ‘*po*.’ ‘*Prinesti*’ (to bring) is classified as an accomplishment: use of this verb means that the sand arrives at a certain destination or goal. The event involves change in Branginsky and Rothstein’s terminology; therefore, its object can be partitive:

- (9) On prines pesku.  
He bring.PERF.PAST sand.PART.  
He brought a little sand.

#### 4 Analysis of the distribution of partitive case

Krifka’s mereological analysis of aspect (1992) provides a way to unify the different classes of verbs that are incompatible with partitive case. Predicates of both objects and events are classified as either *quantized* or *cumulative*. Section 4.2 explains that partitive case NPs are classified as objects with quantized predicates. Section 4.3 contrasts the semantic properties of partitive and accusative mass NPs, and section 4.4 explains how the semantic properties of partitive case NPs are incompatible with cumulative event predicates.

##### 4.1 The quantized/cumulative distinction Krifka (1992)

Both the accomplishment/activity distinction and the perfective/imperfective

distinction are often treated as a distinction between telic and atelic predicates. Telic predicates are compatible with time span adverbials like ‘*in ten minutes.*’ Atelic predicates are compatible with durative adverbials like ‘*for ten minutes.*’ This test supports the reduction of imperfectivity to atelicity (Filip 2001):

- (10) a. On s’el iabloko za desiat’ minut.  
He eat.PERF.PAST apple in ten minutes.  
He ate the apple in ten minutes. Perfective=Telic
- b. On el iabloko desiat’ minut.  
He eat.IMPERF.PAST apple ten minutes  
He ate/was eating a/the apple for ten minutes Imperf.=Atelic

In Krifka’s analysis, the telic/atelic distinction reduces to a distinction between *cumulative* and *quantized* predicates respectively. Cumulativity says that if a predicate applies to two distinct events or entities, it also applies to their sum:

- (11) Cumulativity:  
 $\forall P[\text{CUM}(P) \leftrightarrow \forall x,y[P(x) \wedge P(y) \rightarrow P(x \sqcup y)]]$   
 A predicate P is cumulative iff for any two elements x and y which both satisfy P, the join of x and y also satisfies P.

Mass terms like *applesauce* and bare plurals like *apples* are cumulative. For example, the join of any two amounts of applesauce is itself applesauce. In the domain of events, *run* is cumulative: the join of any two events of running is itself an event of running.

Quantized reference says that whenever a property applies to two entities or events x and y, y cannot be a proper subpart of x:

- (12) Quantized reference:  
 $\forall P[\text{QUA}(P) \leftrightarrow \forall x,y[P(x) \wedge P(y) \rightarrow \neg (y \sqsubset x)]]$   
 A predicate P is quantized iff for any two elements x and y which both satisfy P, it cannot be the case that y is a proper part of x.

If an entity is in the denotation of *an apple*, it cannot have a proper part that is also in the denotation of *an apple*. In the domain of events, no part of an event in the denotation of *run a mile* has a proper part also in the denotation of *run a mile*.

For Slavic languages, imperfective verbs are generally classified as cumulative, and perfective verbs are generally classified as quantized (Krifka 1992, Filip 2000). Braginsky and Rothstein classify delimited activities like (9b), with the perfective verb ‘*ponesti,*’ as “not strictly quantized” (p. 15), defined in (13):

- (13) Strictly quantized reference:  
 $\forall P[\text{SQUA}(P) \leftrightarrow \text{QUA}(P) \wedge \forall x[P(x) \rightarrow \exists y[y \sqsubset x]]]$   
 A predicate P is strictly quantized iff for any element x which satisfies P, there is an element y, and y is a proper part of x.

Delimited activities are classified as not strictly quantized by Braginsky and Rothstein for the following reason: a delimited activity that denotes an event which satisfies a predicate, P, has parts which are also events that satisfy P. This

classifies it as cumulative. However, delimited activities also “denote maximal non-overlapping events,” which I presume means that the join of two delimited activity events that each satisfy P does not itself satisfy P. Therefore, these events are classified as quantized, but not strictly quantized.

Section 3.1 showed that delimited activities are incompatible with partitive case objects, and that the only verbs that do take partitive case are perfective accomplishments. In the terms of Krifka’s classification, only strictly quantized event predicates take partitive case objects.

#### 4.2 Aspectual composition in Russian

In Russian, nouns are bare, and the semantic properties of an object NP, like definiteness or indefiniteness, are influenced by the aspectual properties of the VP (Krifka 1992, Filip 2001)<sup>3</sup>. Aspect is marked morphologically on verbs:

- |      |    |                     |                   |            |
|------|----|---------------------|-------------------|------------|
| (14) |    | <u>Imperfective</u> | <u>Perfective</u> |            |
|      | a. | est’                | s’est’            | ‘to eat’   |
|      | b. | pit’                | vypit’            | ‘to drink’ |

In Russian, perfective and imperfective aspect are operators that have scope over the entire VP. This means quantized VPs have quantized objects, and cumulative VPs have cumulative objects.

As objects of perfectives, count NPs are interpreted as indefinite or definite, but preferably as definite. With imperfectives, their preferred reading is indefinite:

- |      |    |                          |            |                                 |
|------|----|--------------------------|------------|---------------------------------|
| (15) | a. | Ivan s’el                | iabloko.   |                                 |
|      |    | I. eat.PAST.PERF.        | apple.ACC. |                                 |
|      |    | Ivan ate ?an / the apple |            | Perf., NP definite/indefinite   |
|      | b. | Ivan el                  | iabloko.   |                                 |
|      |    | I. eat.PAST.IMPERF.      | apple.ACC  |                                 |
|      |    | Ivan ate an / ?the apple |            | Imperf, NP indefinite/?definite |

The influence of perfective and imperfective aspect on semantic properties of the object is more pronounced when the object is a mass term. As objects of perfectives, mass NPs in accusative case are interpreted as definite. As objects of imperfectives, mass NPs in accusative case are interpreted as indefinite:

- |      |    |                      |          |                            |
|------|----|----------------------|----------|----------------------------|
| (16) | a. | Ona vypila           | chai.    |                            |
|      |    | she drink.PAST.PERF. | tea.ACC. |                            |
|      |    | She drank the tea.   |          | Perf. + Acc.= Definite     |
|      | b. | Ona pila             | chai.    |                            |
|      |    | she drink.PAST.PERF. | tea.ACC. |                            |
|      |    | She drank tea.       |          | Imperf. + Acc.= Indefinite |

Accusative mass terms are interpreted as definite in perfectives because Russian quantized VPs require quantized objects. *Chai* (tea) is a mass term, so it is cumulative. However, all definites are quantized (Krifka : p. 50), so presumably the perfective verb in (16a) forces a definite interpretation. In (16b), the verb is



imperfective; therefore, the VP is cumulative and compatible with the cumulative, indefinite interpretation of the mass term.

Only VPs that are strictly quantized are compatible with partitive case NPs. Quantized VPs force quantized interpretations of their objects; therefore, partitive NPs must be quantized themselves. However, their referential properties contrast with accusative mass terms in the same contexts: partitive NPs are indefinites, not definites. Moreover, partitive case NPs cannot shift their interpretation from quantized to cumulative, as shown by the contrast between (17a-b):

- (17) a.        Ona vypila                      chiau.  
                  She drink.PERF.PAST tea.PART.  
                  She drank a little/some tea.                      Part. NP, Quantized VP
- b.        \*Ona pila                                      chiau  
                  she drink.IMPERF.PAST tea.PART   \*Part. NP, Cumulative VP

Krifka's classification captures the contrast between mass terms in accusative and partitive case: accusative case NPs are either quantized or cumulative, depending on the VP. I will argue that partitive case NPs are quantized only.

### 4.3 Referential properties of accusative and partitive NPs

Partitive case NPs only occur with quantized event predicates, but unlike other objects in this context, they are never interpreted as definite. This provides a clue that the restriction of partitive case to quantized event predicates is related to the distinction between definiteness and indefiniteness.

In Krifka's classification, definite NPs have the property of *singular* reference. Singular NPs are also quantized; therefore, all definites are quantized:

- (18)        Singular reference:  $\forall P[\text{SNG}(P) \leftrightarrow \exists [P(x) \wedge \forall (y) [P(y) \rightarrow x = y]]]$   
               A predicate P has singular reference when there is exactly one x which satisfies P.

The property of singular reference explains how a mass NP, which is cumulative, becomes quantized in the context of a quantized VP. The definite interpretation of accusative mass NPs arises because of this property. The indefinite interpretation of partitive NPs suggests that they are not singular, and that partitive and accusative case NPs have different basic properties:

- (19) a.        Accusative case objects have *cumulativity* as their basic property. *Chai* (tea, accusative) is a cumulative object predicate that is interpreted as definite to make it compatible with a quantized event predicate.
- b.        Partitive case objects have *quantized* reference as their basic property. *Chaiu* (tea, partitive) is a quantized object predicate, so it is compatible with a quantized event predicate.

The lack of singular reference will help to explain why partitive NPs are incompatible with cumulative event predicates.

#### 4.4 Thematic relations

Krifka claims that the domains of both objects and events form a complete join semilattice. The lattice structure is preserved by a homomorphism from objects to events. Event predicates and objects are related by thematic relations with specific properties. The different thematic relations determine the temporal constitution, or aspect, of the event. I argue here that certain properties of partitive case NPs are incompatible with the thematic relations that relate cumulative event predicates to objects.

##### 4.4.1 Activities

Imperfectives and activities (in both their perfective and imperfective forms) have cumulative event predicates. A predicate is cumulative if (but not iff) both the verb and object are cumulative, and the thematic relation,  $\theta$ , is summative:

- (20) Summativity:  
 $\forall [\text{SUM}(R) \leftrightarrow \forall e, e', x, x' [R(e, x) \wedge R(e', x') \rightarrow R(e \sqcup e', x \sqcup x')]]$

Although all thematic relations are summative, summativity is satisfied differently depending on whether the VP is cumulative or quantized (see Krifka (1992 : p. 39). For cumulative VPs, summativity is satisfied in the following way: for the join of any two events  $e_1$  and  $e_2$  which both satisfy *carry*, each event involves its own object ( $x_1$  and  $x_2$  respectively), and the same thematic relation,  $\theta$ . Because *carry* is cumulative, the join of two carrying events is itself a carrying event: *carry*( $e_1 \sqcup e_2$ ). Because *sand* is cumulative, the join of any two entities that satisfy *sand* also satisfies *sand*: *sand*( $x_1 \sqcup x_2$ ). Because of summativity, the join of  $x_1$  and  $x_2$  is the object of the join of  $e_1$  and  $e_2$ :  $\theta(e_1 \sqcup e_2, x_1 \sqcup x_2)$ . This means that the join of any two events that satisfy *carry sand* itself satisfies *carry sand*, and hence is cumulative.

In example (21), the VP is cumulative (an activity), and satisfies summativity:

- (21) On nes pesok.  
 He carry.PAST.IMPERF. sand.ACC.  
 He carried sand / some sand / a little sand.  $\theta$  is summative

In (22), the verb is cumulative. The partitive object is quantized, not cumulative as in (21). The join of any two distinct entities,  $x_1$  and  $x_2$ , that satisfy *pesku* does not itself satisfy *pesku*. I assume that in (22), the conditions for satisfying summativity are not met, and this is why the sentence is ungrammatical:

- (22) \*On nes pesku.  
 He carry.PAST.IMPERF. sand.PART.  $\theta$  is not summative

Classifying partitive case NPs as quantized does not alone account for their incompatibility with cumulative events. Count nouns are also quantized: for example, there is no proper part of an apple that is an apple. However, count nouns do occur as part of cumulative events:

- (23) a. On el iabloko.  
 He el.IMPERF.PAST apple.ACC.SG.

He ate an / the apple. Imperf., quantized NP

- b. On nes arbuz.  
 He carry.IMPERF.PAST watermelon.ACC.SG.  
 He carried a /?the watermelon. Imperf., quantized NP

Example (23b) is a cumulative event; therefore, summativity means that the join of any two events that satisfy *nes arbuz* itself satisfies *nes arbuz*. The verb is cumulative, because the join of two carrying events is itself a carrying event. For the object, the join of two entities that both satisfy *watermelon* seemingly adds up to two watermelons, but this is not what (23b) means. In order to meet the conditions for cumulative event predicates, the join of two entities that both satisfy the predicate *watermelon* must itself satisfy the predicate *watermelon*. The join of two watermelons has to add up to one watermelon.

The property of singular reference can help here. If an NP has singular reference, it is both quantized and cumulative (Krifka: p. 40), for the following reason: if a predicate, P, is singular, then there is exactly one x that satisfies P. For any two entities, x and y, that both satisfy P, the join of x and y is the join of x with itself. The join of x and y therefore satisfies P; hence, x is cumulative. This is needed for cases with cumulative verbs and quantized objects, like (24b).

In imperfective contexts like (23a-b), the preferred interpretation of object NPs is indefinite, not definite. Krifka says that all definites are singular; however, this does not of necessity mean that an NP with singular reference is definite. In English, indefinites can be interpreted as referential as well as quantificational NPs (Fodor & Sag 1982):

- (24) a. Referential NP: refers to a specific individual.  
 b. Quantificational NP: says there is at least one x such that x satisfies a certain property, but it is unspecified who/what it is.

A relative clause facilitates the specific reading of the NP (Fodor & Sag). This test supports the idea that Russian indefinites can have referential readings:

- (25) Katia nesla arbuz, katoryi ona kupila na rynke.  
 K. carry.PAST.PERF. watermelon.SG.ACC that she buy on market  
 Katia carried a /the watermelon that she bought at the market.

If referentiality is associated with singular reference, it explains the aspectual composition of (23b): the event is cumulative, but if the quantized object is interpreted as a referential NP, it has singular reference. Singular reference means it is both quantized and cumulative.

Example (26) shows that a partitive case NP is not compatible with a relative clause. This shows that although partitive NPs and count NPs are both quantized, they differ in that partitive case NPs do not have referential readings:

- (26) \*My vypili chaiu katoryi Katia prigotovila.  
 We drink.PAST.PERF. tea.PART that Katia made.PAST.PERF.



because the partitive case NP, although it is quantized, is not atomic. In example (27a), the VP is atomic, based on its compatibility with the time-span adverbial. It contrasts with (27b) by having a count NP object. If the hypothesis that partitive case NPs are not atomic is correct, I assume that this provides a relevant way to distinguish them from count NPs in imperfective contexts like (27). If an NP is not atomic, it does not have proper parts, and it is therefore not strictly quantized (see definition of strictly quantized reference in (13)). I will use this classification of partitive NPs as quantized, but not strictly quantized, to explain their incompatibility with imperfective accomplishments.

The impossibility of the time-span adverbial in (27b) may be attributable to the fact that an accomplishment verb with a partitive case object does not have an incremental theme. In other words, only object NPs that are strictly quantized are incremental themes. This excludes partitive case NPs. If this hypothesis is correct, it provides a way of distinguishing the imperfective example in (30a) from the ungrammatical example in (30b). In (30a), the object is a count NP, which is strictly quantized, meaning the VP has an incremental theme. Example (30b) has a partitive NP object, which I claim is not an incremental theme:

- (30) a. On el iabloko.  
He eat.IMPERF.PAST apple.ACC.  
He ate / was eating an apple.
- b. \*On el sakharu.  
He eat.IMPERF.PAST sugar-PARTITIVE

I argue here that (30b) is ungrammatical, because imperfective aspect is incompatible with an accomplishment that does not have an incremental theme. Imperfectives in Slavic languages involve a partitivity VP operator, PART, (not to be confused with the partitive case of NPs) which combines with a completed event and yields the corresponding partial event (Filip 2001 : p. 475). Example (30a) asserts that a part of the event denoted by the accomplishment predicate *eat an apple* took place, and it also asserts that a part of an apple was eaten. If the hypothesis that partitive objects are not strictly quantized is correct, then the ungrammaticality in (30b) may be attributable to a conflict between the meaning of the PART VP operator and this structural property of the object. A conflict is expected to arise here, because the partitive object has no proper part that can serve as object of the imperfective (partial) event. The partitive object contrasts in this respect with the count NP in (30a), *iabloko* (apple, accusative). Since *sakharu* (sugar, partitive) does not have proper parts, it may not be possible to assert that a part of some sugar was eaten. In contrast, it is possible to assert that that part of an apple was eaten.

## 5 Conclusions

I have shown that the class of verbs that are compatible with partitive case includes perfective accomplishments, but excludes imperfective accomplishments, and both perfective and imperfective activities. This supports Braginsky and Rothstein's claim that the different lexical classes are relevant for Russian. With Krifka's mereological analysis of aspect, it is possible to

classify verbs that take partitive case as strictly quantized, and verbs that do not as either cumulative (imperfective accomplishments and activities), or as quantized but not strictly quantized (perfective activities). I claim that count NP objects of activities have the property of singular reference, based on their referential readings. Singular reference distinguishes count NPs from partitive case NPs, and I relate the incompatibility of partitive case NPs with activities to this property. The hypothesis that count NPs and partitive case NPs differ with respect to singular reference is compatible with Paducheva's proposal that partitive case NPs are non-referential. With respect to the incompatibility of partitive case with imperfective accomplishments, I propose that imperfective accomplishments always have incremental themes. They do not take partitive case because partitive NPs, based on their incompatibility with time-span adverbials, are not incremental themes.

---

## Notes and References

<sup>1</sup> I would like to thank the audience at WECOL, as well as Lisa Matthewson, Hotze Rullmann, and the participants in the Number and Aspect seminar at UBC in Spring 2006. I am especially grateful to my consultant, Irina Zagorskina. Errors are my own.

<sup>2</sup> Speakers rarely use the partitive case any longer, with genitive case used instead for all mass nouns in partitive contexts (Paus 1994); however, certain nouns such as *chai* ("tea") or *sneq* ("snow") still commonly take partitive case. Russian partitive case is different from Finnish partitive case, which applies to count nouns, and is discussed by Krifka (1992), Kratzer (2004) and others.

<sup>3</sup> In English, the effect is opposite: the referential properties of the argument influence the aspectual properties of the predicate:

a. Activity: John ate apples / apple-sauce for an hour / \*in an hour.

b. Accomplishment: John ate an apple / the apple / the applesauce \*for an hour / in an hour.

- Braginsky, P. & S. Rothstein. 2005. "Imperfective accomplishments in Russian," *Proceedings of IATL 21*, June 22-23, 2005, Israel Institute of Technology, Haifa, Israel.
- Dowty, D. 1991. "Thematic proto-roles and argument selection," *Language*, **67**: 547-619.
- Filip, H. 2001. "Nominal and verbal semantic structure: analogies and interactions," *Language Sciences*, **23**: 453-501.
- Filip, H. 2000. "The quantization puzzle," *Events as grammatical objects from the combined perspectives of lexical semantics, logical semantics & syntax*. Stanford: CSLI.
- Fodor, J.D. & I.A. Sag. 1982. "Referential and quantificational indefinites," *Linguistics and Philosophy*, **5**: 355-398.
- Krifka, M. 1992. "Thematic relations as links between nominal reference and temporal Constitution," *Lexical Matters*. Stanford: CSLI.
- Paducheva, E. 1998. "On noncompatibility of partitive and imperfective in Russian," *Theoretical Linguistics*, **24**(1): 73-82.
- Paus, C. 1994. "Social and pragmatic conditioning in the demise of the Russian partitive case," *Russian Linguistics*, **18**(3): 249-266.

Susie Jones  
University of British Columbia  
Vancouver, B.C., Canada V6T 1Z1  
sujones@interchange.ubc.ca

# The Romans' Destruction the City\*

**Cem Keskin**

Utrecht University

In this paper, I will focus on certain Turkish nominals that are problematic from the perspective of case theory. The problem arises because the objects in these constructions appear to receive structural accusative case from their predicate nouns. First, I will argue against the only proposal in the literature known to me, namely Sezer (1991), which holds that in the constructions in question an abstract light verb must be present. Then, I will propose that it is D, instantiated as nominal agreement, that is responsible for (both genitive and) accusative case assignment in this domain.

## 1 The Problem

Nouns cannot assign case to their complements. Examples along the lines of (1) (Chomsky and Lasnik 1995: 113) are given in the literature to demonstrate this:

- (1) a. \*John's criticism the theory  
b. John's criticism of the theory

However, certain nouns, that I dub verbal nouns (VN), seem to have the ability to assign accusative, dative, locative and ablative cases to their complements in Turkish, in a construction that I term the Verbal Noun Construction (VNC), as in (2):

- (2) a. siz        -in        Rohan   -ı        istila    -nız  
      2.pl     -Gen     Rohan   -Acc    invasion -2.pl  
      'your invasion of Rohan'  
b. ok        -un        hedef   -e        isabet    -i  
      arrow -Gen    target -Dat    hit       -3.sg  
      'the arrow's hitting the target'

Note that these nominals are unlike Turkish nominalizations or English gerunds, which behave similarly with respect to case, in that they are not deverbal. They do not even appear to be derived. Also note that dative, locative and ablative are inherent cases in Turkish (see, e.g. Sezer 1991: 46-49) and their assignment can be linked to  $\theta$ -marking capabilities of VNs (*cf.* Grimshaw and Mester 1988). However, accusative case is structural. So, to spell out the central question: How is accusative case licensed in the VNC?

## 2 A Proposal

### 2.1 Sezer (1991)

Sezer (1991: 51-55, henceforth S91) assumes a link between the VNC in (2) and the Light Verb Construction (LVC) in (3):

- (3) a. Siz        Rohan -i        istila    et        -ti        -niz.  
       2.pl        Rohan -Acc    invasion do    -Past    -2.pl  
       ‘You invaded Rohan.’  
       b. Ok        hedef -e        isabet    et        -ti.  
       arrow target -Dat    hit        do        -Past.3.sg  
       ‘The arrow hit the target.’

He writes the following:

In order to capture the verbal nature of the derived nominals we will propose the following derivation:

- (64) a. (x (y)) [[istila]<sub>N</sub> et]<sub>V</sub> + Acc  
       (x (y)) [[istila]<sub>N</sub> Ø]<sub>V</sub> + Acc  
       b. (x (y)) [[muayene]<sub>N</sub> et]<sub>V</sub> + Acc  
       (x (y)) [[muayene]<sub>N</sub> Ø]<sub>V</sub> + Acc

Derivations in (64)...do not alter the lexical category of the compound verb. Notice that since the derived nominal retains the lexical category of the source, the preservation of the structural case assignment property of the source need not be stipulated. It will be automatically copied to the derived verbal form. We can now safely maintain the condition that nouns, by themselves may not assign ACCUSATIVE case in derived nominals; only verbs can ... the derived nominals in such cases are in fact syntactically verbal.

It would appear that Sezer proposes a lexical derivation where the predicate of the VNC is derived from that of the LVC by replacing the light verb *et*- ‘do’ with a covert counterpart.

### 2.2 Objections

#### 2.2.1 No constraints?

S91 does not constrain the occurrence of the “derived nominal” to the VNC. Thus under his proposal, it should be possible, for instance, to use the form [<sub>V</sub> [<sub>N</sub> *istila*] Ø] ‘invasion’ as the main verb of a clause, just like the form [<sub>V</sub> [<sub>N</sub> *istila*] *et*-] ‘invade’. This never happens.

In fact, constraining the occurrence of the derived form to the VNC might just be impossible: This would mean that it would need to be nominalized if it is to be placed in a VNC. However, this would violate Myers’s Generalization (Myers 1984), given in (4) (from Pesetsky 1995: 75):

- (4) Myers’s Generalization  
 Zero-derived words do not permit the affixation of further derivational morphemes.



So, in fact, Sezer's derived form should only function as the main verb of a clause. This is, of course, the exact opposite of the state of affairs.

Furthermore, assuming that S91 does somehow constrain its occurrence to the VNC, the derived form should allow at least some verbal morphology, just like [<sub>V</sub> [<sub>N</sub> *istila*] *et-*] does when nominalized. However, it does not.

### 2.2.2 Modifiers

Sezer gives the following data (modified from Sezer 1991: 53-54) to argue that the nominals in question are verbal in nature and pave the way for his proposal:

- (5) a. *düşman* -in      *şehir* -i      *hunhar* -\*(ca)      *istila* -sı  
 enemy -Gen      city -Acc      cruel -\*(ly)      invasion -3.sg  
 'the enemy's cruel invasion of the city'
- b. *doktor* -un      *hasta* -yı      \**dikkatli*/      *dikkatle*  
 doctor -Gen      patient -Acc      \*careful /      carefully  
*muayene*      -si  
 examination      -3.sg  
 'the doctor's careful examination of the patient'

First, my judgments are not as clear-cut about (5) as Sezer's. Second, my judgments about the other Turkish data I present here suggest that the state-of-affairs is not as neat as Sezer would make them out to be. This also goes for the judgments of Turkish speakers with whom I have consulted. Take for instance the data in (6), where it is possible to modify the material to right of the object NP by both types of modifiers:

- (6) a. *Siz*      *Rohan* -ı      \**beklenmeyen* /      *ansızın*  
 2.pl      *Rohan* -Acc      \*unexpected /      suddenly  
*istila*      *et*      -ti      -niz.  
 invasion do      -Past      -2.pl  
 'You \*unexpected/suddenly invaded Rohan.'
- b. *siz*      -in      *Rohan* -ı      *beklenmeyen* /      *ansızın*  
 2.pl      -Gen      *Rohan* -Acc      unexpected /      suddenly  
*istila*      -niz  
 invasion -2.pl  
 'your unexpected/sudden invasion of Rohan'

If the structure of *istila* 'invasion' in (6b) were indeed as proposed in S91, i.e. [<sub>V</sub> [<sub>N</sub> *istila*] Ø], we would expect it to be modified only by verbal modifiers, just as the verb *istila et-* 'invade' is, in (6a).

### 2.2.3 Productivity

Certain VNs, such as *istila*, can take part in both the LVC and the VNC, as shown in (7), whereas some others, such as *rapor* 'report', cannot, as in (8):

- (7) a. *Siz*      *Rohan* -ı      *istila*      *et*      -ti      -niz.  
 2.pl      *Rohan* -Acc      invasion do      -Past      -2.pl  
 'You invaded Rohan.'
- b. *siz*      -in      *Rohan* -ı      *istila*      -niz  
 2.pl      -Gen      *Rohan* -Acc      invasion -2.pl  
 'your invasion of Rohan'

- (8) a. Polis olay -ı rapor et -ti.  
 police incident -Acc report do -Past.3.sg  
 ‘The police reported the incident.’  
 b. \*polis -in olay -ı rapor -u  
 \*police -Gen incident -Acc report -3.sg  
 ‘the police’s reporting the incident’

Under S91, due to the link assumed between the LVC and the VNC, there does not seem to be any principled way of explaining why certain VNs can compound both with a putative covert light verb and its overt counterpart *et-*, whereas other VNs cannot.

#### 2.2.4 (Pseudo-)incorporation

Under S91, again due to the link assumed between the LVC and the VNC, it is quite puzzling to observe contrasts in grammaticality between instances of (pseudo-)incorporation in the LVC and nominalizations from the LVC, on the one hand, and the VNC, on the other, as demonstrated in (9)-(11) where incorporated arguments occur adjacent to the predicate without case marking:

- (9) a. Köy -ü fare istila et -ti.  
 village -Acc mouse invasion do -Past.3.sg  
 ‘Mice invaded the village.’  
 b. Çocuk -lar ev işgal et -ti.  
 child -pl house occupation do -Past.3.sg  
 ‘The children occupied a house.’
- (10) a. [Köy -ü fare istila et -me -si] sonucunda  
 [village -Acc mouse invasion do -ANom -3.sg] as a result of  
 bütün hasat heba oldu.  
 entire harvest ruined become:Past.3sg  
 ‘The entire harvest was ruined as a result of mice invading the village.’  
 b. [Çocuk -lar -in ev işgal et -me  
 [child -pl -Gen house occupation do -ANom  
 -si] sonucunda planlar altüst oldu.  
 -3.sg] as a result of plan:pl upside down become:Past.3sg  
 ‘Plans were turned upside down as a result of the children’s occupying a house.’
- (11) a. \*/??[Köy -ü fare istila -sı] sonucunda  
 \*/??[village -Acc mouse invasion -3.sg] as a result of  
 bütün hasat heba oldu.  
 entire harvest ruin become:Past.3sg  
 ‘The entire harvest was ruined as a result of mice invading the village.’  
 b. \*/??[Çocuk -lar -in ev işgal -i]  
 \*/??[child -pl -Gen house occupation -3.sg]  
 sonucunda planlar altüst oldu.  
 as a result of plan:pl upside down become:Past.3sg  
 ‘Plans were turned upside down as a result of the children’s occupying a house.’

Why should arguments be allowed to incorporate into a compound of the sort [<sub>V</sub> [<sub>N</sub> *istila*] *et-*], but not into a compound of the sort [<sub>V</sub> [<sub>N</sub> *istila*]  $\emptyset$ ]?

### 2.2.5 Case patterns

Not all LVCs are created equal. Some LVC predicates appear to be lexically derived while some others syntactically (Balkız Öztürk p.c., also cf. Öztürk 2005: 55-56). Thus, for example, some LVCs allow extraction of VNs and some do not, as shown in (12) ((12b) from Süleyman Nazif's *Çimentepe*) and (13):

- (12) a. *pro* düşman -a hücum et -ti -ler.  
       *pro* enemy -Dat attack do -Past -3.pl  
       ‘They attacked the enemy.’  
       b. [*pro* düşman -a *t* et -tik -leri] hücum  
           [*pro* enemy -Dat *t* do -ObjRel -3.pl] attack  
           Lit. ‘the attack that they did to the enemy’
- (13) a. Siz Rohan -ı istila et -ti -niz.  
       2.pl Rohan -Acc invasion do -Past -2.pl  
       ‘You invaded Rohan.’  
       b. \*[siz -in Rohan -ı *t* et -tiğ  
           \*[2.pl -Gen Rohan -Acc *t* do -ObjRel  
           -iniz] istila  
           -2.pl] invasion  
           Lit. ‘the invasion that you did to Rohan’

Thus the lexical derivation that Sezer proposes to guarantee the preservation, in the VNC, of the case properties of its LVC counterpart cannot be applicable for each VNC-LVC pair. Then, for these cases, this means that the object cases assigned in the VNC are not guaranteed. Hence, it would be quite a coincidence that the same case is assigned in both a syntactically derived VNC, and its LVC ‘counterpart’, and this to be consistently the case for each such VNC-LVC pair without one single exception. If two different elements were indeed responsible for case assignment in the two constructions, we would have good reasons to expect to find at least one VNC where the object is assigned case  $C_1$ , with an LVC counterpart where the object is assigned case  $C_2$ . This never happens. In fact, the case assigned to the object co-varies consistently with the VN in parallel fashion in both constructions, which is rather suggestive.

### 2.2.6 Inherent case

Recall that dative, locative and ablative cases are inherent in Turkish and “[i]f A is an inherent case assigner, then A assigns case to an NP if and only if A  $\theta$ -marks the NP” Chomsky (1986: 194). Now, if the VN is the  $\theta$ -marker in the Turkish LVC, then it follows that the dative, for instance, is licensed by the VN in Turkish, in and out of the LVC, without any need for an abstract light verb.

Under S91, this predicts a contrast between VNCs with lexically derived predicates and those with syntactically derived predicates where the object receives an inherent case. We would expect the former to be modified by both noun and verb modifiers (because it is actually of the form [<sub>V</sub> [<sub>N</sub> VN]  $\emptyset$ ]), whereas the latter should be modified only by noun modifiers (because, basically, it is just a noun). This prediction is not borne out as seen in (14):

- (14) a. [siz -in [Rohan -i [beklenmeyen / ansızın  
 [2.pl -Gen [Rohan -Acc unexpected / suddenly  
 istila -nız ]]]  
 invasion -2.pl]]  
 ‘your unexpected/sudden invasion of Rohan’
- b. [siz -in [Rohan -a [beklenmeyen / ansızın  
 [2.pl -Gen [Rohan -Dat [unexpected / suddenly  
 hücum -unuz]]]  
 attack -2.pl]]]  
 ‘your unexpected/sudden attack on Rohan’

### 2.3 Interim conclusion

I have argued against S91 from a number of perspectives. I have pointed out that the application of Sezer’s (1991) proposal might simply be impossible, due to Myers’ Generalization. Because the foundation of the proposal in S91 is the *prima facie* similarity between the VNC and the LVC, I have also used the strategy of showing the differences between the two constructions, differences S91 predicts not to exist. These differences concerned the morphological markers and modifiers allowed in the two environments, productivity of the two constructions and argument incorporation. I have also claimed that S91 predicts certain differences, with respect to case-assignment patterns, between the VNC and the LVC. S91 also predicts differences between different types of VNC, with respect to modifiers. These differences do not exist, contra S91. Consequently, it would appear that the solution offered by Sezer (1991) to the problem at hand is not tenable in its current form. It might be possible to remedy it but that is not the track that will be pursued in this paper. Instead, I will propose an alternative solution that is substantially different. The following sections outline this proposal and provide support for it.

## 3 The Proposal

### 3.1 D

This proposal is embedded in the framework laid out mainly by Chomsky (2000, 2001, 2004, 2005). Assuming that Turkish nominal agreement (Note the person and number marking on the VNs.) is an instantiation of D (Kennelly 2004) and that D is a phase head (Chomsky 2005, Svenonius 2003), I propose here that  $\phi$ -features necessary for accusative case assignment in the Turkish VNC are provided by D. I can think of two theoretically possible implementations of this idea:

1. Feature copying: The  $\phi$ -feature set of D is copied onto  $X^0$  that assigns case to the object through Agree, while D itself assigns case to the subject.
2. ‘Multiple’ Agree: The  $\phi$ -features of D establish Agree relations with both the subject and the object, and assign case to both (*cf.* Pesetsky and Torrego 2001: 366-367).

### 3.2 The evidence

#### 3.2.1 Case & D

If the existence of D entails structural case assignment in the VNC, then, simply put, no structural case in the VNC, no D in the VNC<sup>1</sup>. An environment to test this prediction is the Japanese version of the VNC. The crucial feature of this construction is that in contrast to Turkish VNC, it does not allow structural case assignment, as shown in (15) (data from Mana Kobuchi-Philip, p.c.), where the Japanese genitive marker *no* does not realize a structural case (Inoue 2006):

- (15) a. siz -in Rohan -i istila -niz  
 2.pl -Gen Rohan -Acc invasion -2.pl  
 ‘your invasion of Rohan’  
 b. gun -no sono machi (-\*o / -no) hakai  
 army -Gen that city (-\*Acc / -Gen) destruction  
 ‘the army’s destruction of that city’

According to our prediction, the Japanese VNC should have no D. In fact, Fukui (1986: 227) proposes that only functional heads close a projection and claims that there is no D in Japanese evidenced by the following fact:

[G]enitive phrases, as well as demonstratives, do not close off the projection of N, so that the following Japanese examples [in (16)] are all grammatical in contrast to the corresponding English phrases in the quotes, which are all ungrammatical.

- (16) a. Yamada -sensei -no so-no koogi  
 Y. -teacher -Gen that/the lecture  
 Lit. ‘Prof. Yamada’s that/the lecture’  
 b. kyonen -no Yamada -sensei -no so-no koogi  
 last year -Gen Y. -teacher -Gen that/the lecture  
 Lit. ‘last year’s Prof. Yamada’s that/the lecture’  
 c. Tokyo -daigaku -(de) -no sensyuu -no  
 T. -university -(at) -Gen last week -Gen  
 Yamada -sensei -no so-no koogi  
 Y. -teacher -Gen that/the lecture  
 Lit. ‘Tokyo University’s last week’s Prof. Yamada’s that/the lecture’

What this would entail for the VNC is that, being a nominal, it should be open in Japanese but closed in Turkish. This is indeed the case, as demonstrated by (17) and (18) (Japanese data from Mana Kobuchi-Philip, p.c.):

- (17) a. [Gun -no sono machi -no hakai] -wa  
 [army -Gen that city -Gen destruction] -Top  
 igai datta.  
 unexpected was  
 ‘The army’s destruction of that city was unexpected.’

- b. [Kyonen -no gun -no sono machi -no hakai]  
 [last year-Gen army -Gen that city -Gen destruction]  
 -wa igai datta.  
 -Top unexpected was  
 Lit.: 'Last year's the army's destruction of that city was unexpected.'
- c. [Hokkaido -(de) -no kyonen -no gun -no sono]  
 [Hokkaido -(loc) -Gen last year -Gen army -Gen that  
 machi -no hakai] -wa igai datta.  
 city -Gen destruction] -top unexpected was  
 Lit.: 'Hokkaido's last year's the army's destruction of that city was unexpected.'
- (18) a. [Ordu -nun kent -i feth -i] beklenmiyordu.  
 [army -Gen city -Acc conquest-3.sg] was not expected  
 'The army's conquest of the city was not expected.'
- b. \*[Geçen yıl -in ordu -nun kent -i feth  
 \*[last year -Gen army -Gen city -Acc conquest  
 -i] beklenmiyordu.  
 -3.sg] was not expected  
 Lit.: 'Last year's the army's conquest of the city was not expected.'
- c. \*[Doğu -nun geçen yıl -in ordu -nun kent -i  
 \*[east -Gen last year -Gen army -Gen city -Acc  
 feth -i] beklenmiyordu.  
 conquest -3.sg] was not expected  
 Lit.: 'East's last year's the army's conquest of the city was not expected.'

### 3.2.2 Focus & D

We can support the present proposal further if we can find another phenomenon linked to agreement and show that it lacks in the Japanese VNC but is present in the Turkish VNC. One such phenomenon is focus: Chomsky (2005) and Miyagawa (to appear) argue that the phase head C is responsible for both agreement (and hence, case assignment) and focus. This would mean that if  $D^0$  is the locus of agreement (and hence case) in Turkish, it is likely that it is also the locus of focus. Then, we should expect the picture to be identical to that of case: focus in the Turkish VNC, no focus in the Japanese VNC. That is indeed the case, as shown in (19)-(20) (Japanese data from Mana Kobuchi-Philip, p.c.)<sup>2</sup>:

- (19) a. [Ordu -nun da kent -i feth -i]  
 [army -Gen Foc city -Acc conquest-3.sg]  
 beklenmedikti.  
 was unexpected  
 'The ARMY's conquest of the city was unexpected, too.'
- b. [Ordu -nun kent -i de feth -i]  
 [army -Gen city -Acc Foc conquest-3.sg]  
 beklenmedikti.  
 was unexpected  
 'The army's conquest of the CITY was unexpected, too.'

- (20) a. \*[Gun -mo sono machi -no hakai] -wa  
 \*[army -Foc that city -Gen destruction] -Top  
 igai datta.  
 unexpected was  
 ‘The ARMY’s destruction of the city was unexpected, too.’
- b. \*[Gun -no sono machi -mo hakai] -wa  
 \*[army -Gen that city -Foc destruction] -Top  
 igai datta.  
 unexpected was  
 ‘The army’s destruction of the CITY was unexpected, too.’

### 3.3 Interim conclusion

To summarize, I have proposed that D provides the  $\phi$ -features necessary for structural case-assignment to (both the subject and) the object in the VNC. To test this hypothesis, I have compared data from Turkish and Japanese, the former a language that has a D head in nominals, instantiated by nominal agreement, and the latter a language that has none. I have noted that the presence of D positively correlates with structural case assignment to the subject and, more importantly for my proposal, to the object in the VNC. Furthermore, on the basis of works that connect agreement features (hence, structural case-assignment) and focus features I have shown that a positive correlation holds between the presence of D and focus marking on (subjects and) objects in the VNC in Turkish and Japanese, providing further support for my proposal.

## 4 Conclusion

In this paper, I have focused on a certain type of Turkish nominals, the VNC, which is problematic from the perspective of case theory. The problem arises because the objects in this construction appear to receive structural accusative case from their predicate nouns. First, I have argued against the only proposal in the literature known to me, namely Sezer (1991), which holds that in the construction in question an abstract light verb must be present. Then, I have proposed that it is D, instantiated as nominal agreement, that is responsible for (both genitive and) accusative case assignment in this domain.

## Notes

\* Versions of this paper have been presented at the 3<sup>rd</sup> Workshop on Altaic in Formal Linguistics (Moscow State University), the 13<sup>th</sup> International Congress on Turkish Linguistics (Uppsala University) and TABU-dag 2006 (University of Groningen). Thanks to these audiences and the WECOL 2007 audience, as well as to Norbert Corver, Martin Everaert, Riny Huybregts, Mario van Koppen, Hideaki Yamashita and Shin Fukuda for their comments. The usual disclaimers apply. Finally, warm thanks to Brian Agbayani, Chris Golston and Vida Samiian for the wonderful job they have done in organizing WECOL 2007.

<sup>1</sup> Evidently, this formulation is too vague. If it is interpreted as a logical implication, it wrongly predicts that it should be possible to assign structural case to the object in English derived nominals, under the standard analysis (Abney 1987), where the construction would be headed by D. Alternatively, it presupposes a non-standard analysis where the construction lacks a D head, also an undesirable consequence. One way to refine the statement is by recasting it as a biconditional and taking recourse to  $\phi$ -features: Structural case assignment in the nominal domain is possible iff there is a  $\phi$ -complete D head. Note that nominal agree-

ment instantiating D in Turkish is  $\phi$ -complete (Gender has no grammatical realization in Turkish). So, one could say that  $\phi$ -complete D would imply structural case assignment, and the lack of it no structural case assignment (and the converse of both). This would cover both English (with  $\phi$ -incomplete D all around) and Japanese (without D).

<sup>2</sup> Speakers of Japanese inform me that these sentences are perfect when *mo* 'also' is replaced with *dake* 'only'. These two focus particles fall into two separate categories: *mo* is a K-particle and *dake* an F-particle (Aoyagi 1999). Japanese syntactic literature proposes different licensing mechanisms for these two types of focus particle.

## References

- Abney, Steven. 1987. The English Noun Phrase in its Sentential Aspect. Doctoral dissertation, MIT, Cambridge, Massachusetts.
- Aoyagi, Hiroshi. 1999. On association of quantifier-like particles with focus in Japanese. In *Linguistics: in search of the human mind – a Festschrift for Kazuko Inoue*, ed. Masatake Muraki and Enoch Iwamoto, 24-56. Tokyo: Kaitakusha.
- Chomsky, Noam. 1986. *Knowledge of Language: Its Nature, Origin and Use*. New York, New York State: Praeger.
- Chomsky, Noam. 2000. Minimalist inquiries. In *Step by Step: Essays on Minimalist Syntax in Honor of Howard Lasnik*, ed. Roger Martin, David Michaels and Juan Uriagereka, 89-155. Cambridge, Massachusetts: The MIT Press.
- Chomsky, Noam. 2001. Derivation by phase. In *Ken Hale: A Life in Language*, ed. Michael Kenstowicz, 1-52. Cambridge, Massachusetts: The MIT Press.
- Chomsky, Noam. 2004. Beyond explanatory adequacy. In *The Cartography of Syntactic Structures Vol. 3, Structures and Beyond*, ed. Adriana Belletti, 104-131. Oxford: Oxford University Press.
- Chomsky, Noam. 2005. "Three factors in language design", *Linguistic Inquiry*, 36. 1: 1-22.
- Chomsky, Noam. and Howard Lasnik. 1995. The theory of principles and parameters. In *The Minimalist Program*, Noam Chomsky, 13-127. Cambridge, Massachusetts: The MIT Press.
- Fukui, Naoki. 1986. A Theory of Category Projection and Its Applications. Doctoral dissertation, MIT, Cambridge, Massachusetts.
- Grimshaw, Jane and Armin Mester. 1988. "Light verbs and  $\theta$ -marking", *Linguistic Inquiry*, 19. 2: 205-232.
- Inoue, Kazuko. 2006. Case in Japanese. In *The Blackwell Companion to Syntax*, ed. Martin Everaert and Henk van Riemsdijk, 295-373. Malden, Massachusetts: Blackwell Publishing.
- Kennelly, Sarah. 2004. *Quantificational Dependencies*. Utrecht: LOT publications.
- Myers, Scott. 1984. Zero-derivation and inflection. In *MIT working papers in linguistics 7: Papers from the January 1984 MIT Workshop in Morphology*, Department of Linguistics and Philosophy, MIT, Cambridge, Massachusetts.
- Miyagawa, Shigeru. to appear. Unifying agreement and agreement-less languages. In *Proceedings of WAFL2*. Cambridge, Massachusetts: MIT Working Papers in Linguistics.
- Öztürk, Balkız. 2005. *Case, Referentiality and Phrase Structure*. Amsterdam: John Benjamins.
- Pesetsky, David. 1995. *Zero Syntax: Experiencers and Cascades*. Cambridge, Massachusetts: MIT Press.
- Pesetsky, D. and Esther Torrego. 2001. T-to-C movement: Causes and consequences. In *Ken Hale: A Life in Language*, ed. Michael Kenstowicz, 355-426. Cambridge, Massachusetts: The MIT Press.
- Sezer, Engin Fehmi. 1991. *Issues in Turkish Syntax*. Doctoral dissertation, Harvard University, Cambridge, Massachusetts.
- Svenonius, Peter. 2003. On the Edge. Ms., University of Tromsø, Norway.

Cem Keskin  
Utrecht institute of Linguistics OTS  
Janskerkhof 13, 3512 BL, Utrecht, The Netherlands  
cem.keskin@let.uu.nl



# Similarity Avoidance in East Bengali Fixed-Segment Echo Reduplication

Sameer ud Dowla Khan  
UC Los Angeles

## Abstract

Many languages employ reduplication processes in which one segment of the reduplicant is fixed. In East Bengali, /t/ is normally the initial consonant in reduplicants of this type (/gɑi-tɑi/ ‘cars, etc.’). However, when the base itself begins with /t/, speakers prefer alternate fixed segments, such as /f/ or /m/ (not \*/tæg.ɪɑ-tæg.ɪɑ/, but /tæg.ɪɑ-mæg.ɪɑ/ ‘cross-eyed, etc.’). Speakers also tend to avoid fixed segment /t/ when the base begins with a consonant that is similar to /t/ (not ??/t<sup>h</sup>oŋga tɔŋga/, but /t<sup>h</sup>oŋga fɔŋga/ ‘bags, etc.’). Results of an experiment indicate that bases beginning with consonants similar to /t/ (e.g. /t<sup>h</sup>/ or /d/) take reduplicants with fixed segment /t/ far less often than bases beginning with consonants dissimilar to /t/ (e.g. /p/ or /b<sup>h</sup>/). If the avoidance of similarity between the initial consonants of base and reduplicant is indeed at work, on what basis is similarity being measured? To determine consonant similarity, speakers could be accessing language-specific measures of consonant similarity by observing the patterns in their lexicon, or they could be using a more universal measure of similarity, based on the phonological features of each consonant. To better understand the measurement of similarity, four metrics were tested against the experimental data. The current study explores a simple model in which similarity is determined by the weighted sum of shared features. One hypothesis regarding the source of these weights is considered here – a feature’s weight may reflect its ability to contrast the phonemes of the language.

## 1 Introduction

### 1.1 The question: how is similarity calculated?

The concept of similarity has been shown to be phonologically important in numerous studies, including Frisch (1996), Frisch, Pierrehumbert, & Broe

(2004), Rose & Walker (2004), Coetzee & Pater (2005), Herd (2005), Mackenzie (2005), Bailey & Hahn (2005), Kessler (2005), and many others.<sup>1</sup> Data on the phenomenon of *similarity avoidance* was gathered in an experiment on East Bengali echo reduplication discussed below. But how is similarity actually calculated? To answer this question, four theories of similarity were tested against the experimental data and compared to one another.

### 1.2 The alternation: East Bengali fixed-segment echo reduplication

Fixed-segment reduplication involves copying all base material into the reduplicant, except for one part, which is replaced with a fixed segment (FS) (McCarthy & Prince 1986, Nevins & Wagner 2001); echo reduplication is one instantiation of this process. The default East Bengali echo reduplication pattern is shown in ( 1 ) and ( 2 ), where the reduplicant-initial segment is usually replaced with default fixed segment /t/:<sup>2</sup>

- |       |                        |               |       |           |                |
|-------|------------------------|---------------|-------|-----------|----------------|
| ( 1 ) | pani                   | ‘water’       | ( 2 ) | kafi      | ‘cough(s)’     |
|       | pani tani <sup>3</sup> | ‘water, etc.’ |       | kafi tafi | ‘coughs, etc.’ |

However, alternate fixed segments (e.g. /f/, /m/, /z/, /p/, /b/) are also attested, as in ( 3 ) and ( 4 ) below:

- |       |           |                  |       |              |                 |
|-------|-----------|------------------|-------|--------------|-----------------|
| ( 3 ) | tika      | ‘vaccine(s)’     | ( 4 ) | tʃak.ɿ       | ‘career(s)’     |
|       | tika fika | ‘vaccines, etc.’ |       | tʃak.ɿ bak.ɿ | ‘careers, etc.’ |

### 1.3 The phenomena: identity- and similarity avoidance

The choice of fixed segment is subject to two restrictions: identity avoidance and similarity avoidance. Identity avoidance is the rejection of reduplicants with a fixed segment identical to the segment being replaced, as in ( 5 ) and ( 6 ):

- |       |              |                    |       |            |                     |
|-------|--------------|--------------------|-------|------------|---------------------|
| ( 5 ) | tip:a        | ‘having pressed’   | ( 6 ) | mu.ɿ       | ‘puffed rice’       |
|       | *tip:a tip:a | ‘h. pressed, etc.’ |       | mu.ɿ tu.ɿ  | ‘puffed rice, etc.’ |
|       | tip:a mip:a  | ‘h. pressed, etc.’ |       | *mu.ɿ mu.ɿ | ‘puffed rice, etc.’ |

Speakers also tend to reject reduplicants with a fixed segment merely similar to the segment being replaced (*i.e.* similarity avoidance), as in ( 7 ) and ( 8 ):

- |       |               |                   |       |            |               |
|-------|---------------|-------------------|-------|------------|---------------|
| ( 7 ) | tʰæk.a        | ‘obstacle(s)’     | ( 8 ) | ʃala       | ‘lock(s)’     |
|       | *tʰæk.a tæk.a | ‘obstacles, etc.’ |       | ?ʃala tala | ‘locks, etc.’ |
|       | tʰæk.a fæk.a  | ‘obstacles, etc.’ |       | ʃala pala  | ‘locks, etc.’ |
|       | tʰæk.a mæk.a  | ‘obstacles, etc.’ |       | ʃala mala  | ‘locks, etc.’ |

## 2 Experiment

### 2.1 Research question

Having briefly described the phenomenon of similarity avoidance, it is nevertheless unclear on what basis speakers are judging similarity. Do features and natural classes play a role? Do patterns in the lexicon play a role? Does the phoneme inventory play a role? To better understand what factors determine consonant similarity, an experiment was carried out with the purpose of gathering data on echo reduplication using productions of native speakers. Using this data, four theories of similarity were tested against the observed patterns.

### 2.2 Methods

Thirty (30) adult native speakers of Bengali were presented auditorily with recordings of 60 native Bengali disyllabic roots, grouped by their initial consonant.<sup>4</sup> These included eight (8) stimuli beginning with /t/ (*i.e.* the identity condition), 23 stimuli beginning with consonants potentially considered similar to /t/ – /t<sup>h</sup>, d, t̪, t̪<sup>h</sup>, tʃ/ – (*i.e.* the similarity condition), and 29 stimuli beginning with other consonants (*i.e.* the control condition). No word included consonants from the similarity condition (*i.e.* /t<sup>h</sup>, d, t̪, t̪<sup>h</sup>, tʃ/) in non-initial position.

The stimuli were produced in two dialects spoken in urban Bangladesh (*i.e.* Standard Bengali and East Bengali)<sup>5</sup> by an adult female speaker in a sound-proof booth. The order of stimuli was randomized for each subject. After the stimulus was played aloud to subject (who chose the dialect in which to hear the stimuli), the subject was asked to repeat the word aloud with its reduplicant.

### 2.3 Results

The experimental results confirm that the overall pattern of echo reduplication exhibits both identity- and similarity avoidance. Bases with initial consonants such as /t, t<sup>h</sup>, d, t̪/ took very few reduplicants with fixed segment /t/, while bases with initial consonants such as /l, m, p, b<sup>h</sup>/ most often took reduplicants with fixed segment /t/. Bases with other initial consonants – those of intermediate similarity to /t/ – showed more variable behavior. As shown in Figure 1, the percentage of fixed segment /t/-use in echo reduplicants is inversely related to the presumed similarity between /t/ and the base-initial consonant.

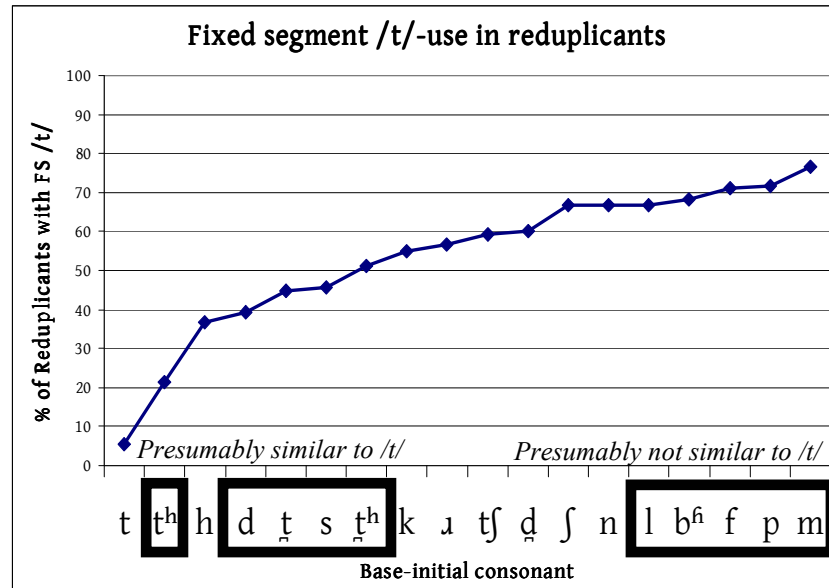

**Figure 1.** Fixed segment /t/-use in reduplicants, arranged by base-initial consonant.

### 3 Analysis

What theory could explain the experimental data? Four theories of similarity are considered: lexical cooccurrence restrictions (OCP), the shared natural classes metric, relativized OCP constraints, and feature weighting.

#### 3.1 Theory I: lexical cooccurrence restrictions (OCP)

The Obligatory Contour Principle (OCP) describes the tendency of identical (and similar) consonants to cooccur less frequently than more dissimilar consonants within roots in a given lexicon (McCarthy 1986, Pierrehumbert 1993). If these OCP restrictions in the lexicon are the only constraints penalizing similarity in the productive grammar, then speakers could infer similarity values from cooccurrence rates in the lexicon – or, similarity values might come from some other source, but still be reflected in both lexical cooccurrence rates and reduplicative behavior. Thus, bases with initial consonants that cooccur less often with /t/ in the lexicon should allow fewer /t/-reduplicants than other bases. If this prediction is borne out, we can conclude that similarity is a potentially language-specific measure, based on or at least related to patterns in the lexicon.

### 3.1.1 Implementation

To test this theory, the cooccurrence of /t/ with each consonant (C) in roots of the shape /tVCV/ and /CVtV/ was calculated as in (9), using phoneme distribution data from Mallik *et al.* (1998). The numerator represents observed cooccurrence and the denominator represents expected cooccurrence.

$$(9) \quad \frac{\text{Observed } \{C, t\} \text{ cooccurrence in roots}}{\text{Total roots}} \\ \frac{\text{Observed } /C/ \text{ occurrence in roots}}{\text{Total roots}} \times \frac{\text{Observed } /t/ \text{ occurrence in roots}}{\text{Total roots}}$$

If /t/ and a consonant C cooccur with an Observed/Expected (O/E) value less than 1, it is likely that the two consonants are subject to a cooccurrence restriction, and are thus considered more similar to each other in the language. An O/E value greater than 1 suggests that /t/ and the consonant C are not subject to a cooccurrence restriction, and are being treated as less similar to each other.

### 3.1.2 Comparison with results

Figure 2 compares O/E values (multiplied by a constant 30) to the observed data.

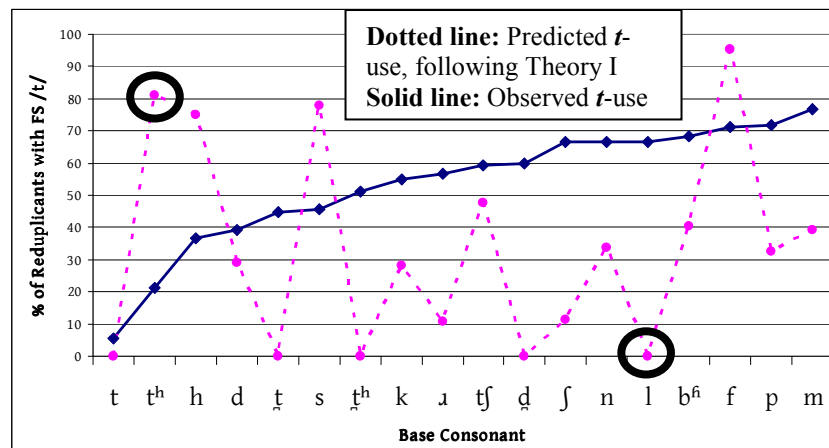

**Figure 2.** Fixed segment /t/-use in reduplicants as predicted by Theory I/lexical cooccurrence restrictions (dotted) versus observed data (solid).

As illustrated in Figure 2, there is no correlation between the predictions of Theory I (lexical cooccurrence restrictions) and the experimental data [ $r^2 = .004$ ,

$p = 0.81$ ]. Two points in Figure 2 are circled as illustrations of inaccurate predictions made by Theory I. Bases with initial /t<sup>h</sup>/ are wrongly predicted to almost exclusively take /t/ as the fixed segment, due to the large number of words like /t<sup>h</sup>ōte/ ‘lips (LOC)’, with /t<sup>h</sup>/ and /t/ cooccurring within the same root, while experimental data such as ( 10 ) show that /t<sup>h</sup>/-initial bases *do not* take fixed segment /t/ over 78% of the time. Conversely, bases with initial /l/ are wrongly predicted to never take /t/ as the fixed segment in echo reduplicants, due to the lack of roots of the shape /lVtV/. In the experimental data, over 65% of /l/-initial bases in fact do take fixed segment /t/, as in ( 11 ).

|        |                          |                |        |           |              |
|--------|--------------------------|----------------|--------|-----------|--------------|
| ( 10 ) | t <sup>h</sup> oka       | ‘knock(s)’     | ( 11 ) | loha      | ‘iron (Fe)’  |
|        | *t <sup>h</sup> oka toka | ‘knocks, etc.’ |        | loha toha | ‘iron, etc.’ |

The lack of correlation between Theory I and the observed data strongly suggests that the cooccurrence restrictions present in the Bengali lexicon are unrelated to the cooccurrence restrictions seen in echo reduplication.

### 3.2 Theory II: shared natural classes metric

Frisch (1996) proposes a similarity metric that counts the number of natural classes shared by two sounds, as in ( 12 ).<sup>6</sup> This metric was shown in Frisch *et al.* (2004) and subsequent studies to describe the lexicon and grammar of Arabic.

#### 3.2.1 Implementation

The similarity score of each consonant with /t/ was calculated in the software program Similar.exe (Zuraw, n.d.) using the following equation:

$$( 12 ) \quad \text{Similarity } \{ /t/, C \} = \frac{\# \text{ of natural classes containing both } /t/ \text{ and } C^7}{\# \text{ of natural classes containing } /t/ \text{ and/or } C}$$

Higher similarity scores (*i.e.* approaching 1) indicate more similar consonants, while lower scores (*i.e.* approaching 0) indicate less similar consonants. Following this metric of similarity, bases with initial consonants that share more natural classes with /t/ should take fewer /t/-reduplicants than other bases. This would suggest that similarity measurement has both a universal component (*i.e.* features) and a language-specific component (*i.e.* the phoneme inventory).

#### 3.2.2 Comparison with results

The shared natural classes metric is better than Theory I at predicting most of the experimental results [ $r^2 = .584$ ,  $p < 0.01$ ]. However, it cannot predict the contrasts among the consonants in the similarity condition; the most striking

examples of incorrect predictions are circled in Figure 3. Note how Theory II predicts that /t̥/ is most similar to /t/, followed by /tʃ/, /d/, and then /tʰ/, while the data suggests that /tʰ/ is most similar to /t/, followed by /d/, /t̥/, and then /tʃ/.

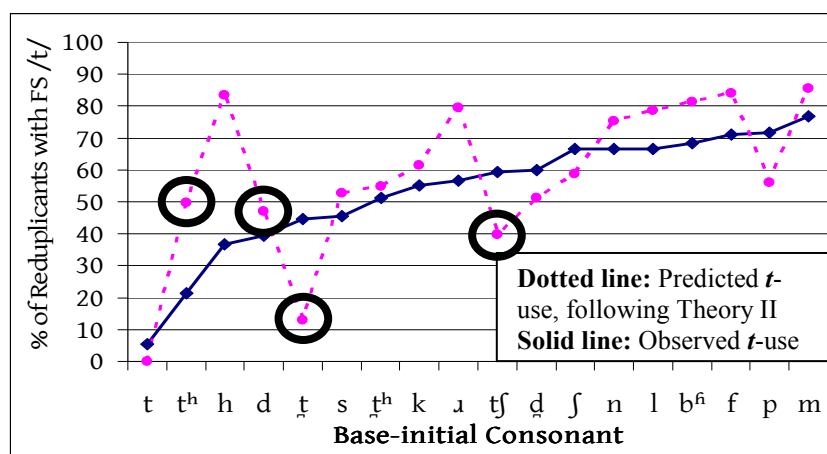

**Figure 3.** Fixed segment /t/-use in reduplicants as predicted by Theory II/shared natural classes metric (dotted) versus observed data (solid).

### 3.3 Theory III: relativized OCP constraints

Coetzee & Pater (2005) proposes an Optimality Theoretic (Prince & Smolensky 1993) account of Muna, where OCP constraints against certain larger feature combinations (e.g. OCP-LAB [ $\alpha$ CNT][ $\alpha$ SON]) are ranked above OCP constraints against smaller combinations thereof (e.g. OCP-LAB [ $\alpha$ SON]); these are then ranked above a general OCP constraint (e.g. OCP-LAB). This ranking derives from the lexicon by an algorithm based on the type frequency of lexical exceptions to weak OCP constraints, and is used to describe lexical OCP restrictions. Applying this measure of similarity to Bengali, bases with initial consonants that share more combinations of features with /t/ should take fewer /t/-reduplicants than other bases (although, of course, the ranking would not derive from the Bengali lexicon, as it was shown in Section 3.1.2 that lexical patterns are a poor model of reduplicative phenomena). Like Theory II/shared natural classes metric, this theory would suggest that the measurement of similarity has both a universal component (i.e. the features) and a potentially language-specific component (i.e. the lexicon).

#### 3.3.1 Implementation

As formulated in Coetzee & Pater (2005), the relativized OCP constraint ranking derives from the lexicon. However, since cooccurrence rates in the lexicon were

found to be not correlated with the reduplication facts (see Section 3.1.2), such a ranking would be useless. Thus, the relativized OCP constraint hierarchy in (11) is directly fitted to the reduplication data making no reference to the lexicon:<sup>8</sup>

- (13) OCP-COR ( $\alpha$ s.g.,  $\alpha$ voi.,  $\alpha$ dist.,  $\alpha$ del.rel.,  $\alpha$ ant.,  $\alpha$ son.,  $\alpha$ nas.,  $\alpha$ lat.) »  
 OCP-COR ( $\alpha$ voi.,  $\alpha$ dist.,  $\alpha$ del.rel.,  $\alpha$ ant.,  $\alpha$ son.,  $\alpha$ nas.,  $\alpha$ lat.) »  
 OCP-COR ( $\alpha$ dist.,  $\alpha$ del.rel.,  $\alpha$ ant.,  $\alpha$ son.,  $\alpha$ nas.,  $\alpha$ lat.) »  
 OCP-COR ( $\alpha$ del.rel.,  $\alpha$ ant.,  $\alpha$ son.,  $\alpha$ nas.,  $\alpha$ lat.) »  
 OCP-COR ( $\alpha$ ant.,  $\alpha$ son.,  $\alpha$ nas.,  $\alpha$ lat.) »  
 OCP-COR ( $\alpha$ son.,  $\alpha$ nas.,  $\alpha$ lat.) »  
 OCP-COR ( $\alpha$ nas.,  $\alpha$ lat.) »  
 OCP-COR ( $\alpha$ lat.) »  
 OCP-COR

### 3.3.2 Comparison with results

Theory III, as modified to make no reference to the Bengali lexicon, is a relatively close match to the observed data [ $r^2 = .717$ ,  $p < 0.01$ ].

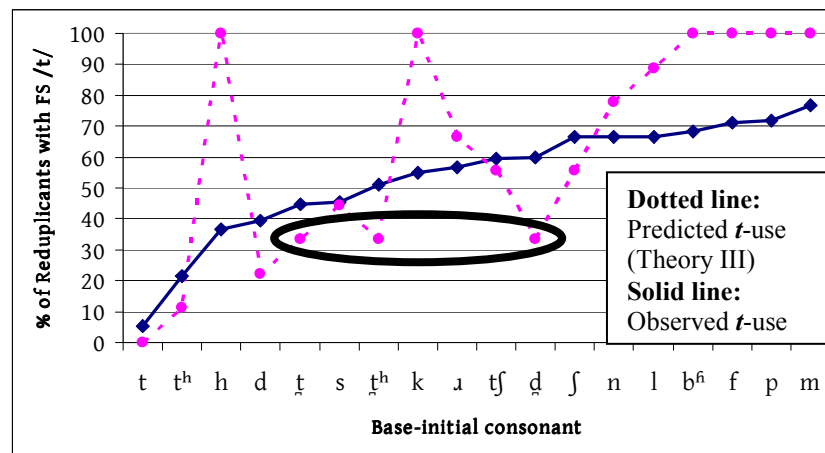

**Figure 4.** Fixed segment /t/-use in reduplicants as predicted by Theory III/relativized OCP constraints (dotted) versus observed data (solid).

Note, however, that all dentals /ṭ, ṭ<sup>h</sup>, ɖ/ are predicted by Theory III to be equally similar to /t/, when the data indicates /t/ is more similar to /ṭ/ than to /ṭ<sup>h</sup>/ or /ɖ/.

### 3.4 Theory IV: feature weighting

Consonant similarity may be measured by counting shared features. However, some features may be more important than others. Thus, when calculating the



similarity of two consonants, certain features are more heavily weighted than others (Ladefoged 1969). By assuming that features can have unequal weights, we can predict that bases with initial consonants that share a greater total shared feature *weight* (as opposed to the raw *number* of features shared) with /t/ will take fewer /t/-reduplicants than other bases. If this prediction is borne out, we could conclude that the measurement of similarity has a universal component (*i.e.* features) while allowing for (possibly language-specific) weights.

### 3.4.1 Implementation

As the lexicon has been shown to be a poor source of similarity measurements in the results of Theory I, we can only gather information on consonant similarity from the reduplication data itself. Thus, the calculation of feature weights was performed using the software program R (R Development Core Team 2005) by fitting the  $sim(C, t)$  values in (14) to the observed values of  $P$ :<sup>9</sup>

$$(14) \quad P = ((m!) / (n!(m - n)!)) (1 - sim(C, t))^n (sim(C, t))^{m-n}$$

Where  $P$  is the probability that base-initial  $C$  will cooccur with default fixed segment /t/  $n$  times out of  $m$  trials, and  $sim(C, t)$  was calculated as in (15):

$$(15) \quad sim(C, t) = \exp(-\sum_{i=1}^{\#ftrs} w_i(1 - \delta_i(C, t)))$$

The weights found to be most effective in modeling the data are as follows: all but four features received the default weight ( $w$ ) of 0.100. The four features that were found to have heavier weights were [voice] ( $w = 0.554$ ), [distributed] ( $w = 0.400$ ), [strident] ( $w = 0.249$ ), and [spread glottis] ( $w = 0.198$ ). These four features turn out to be independently important in the language. This is discussed further in Section 5.

### 3.4.2 Comparison with results

Feature weighting achieves the best match with the experimental data [ $r^2 = .855$ ,  $p < 0.01$ ], as shown in Figure 5.

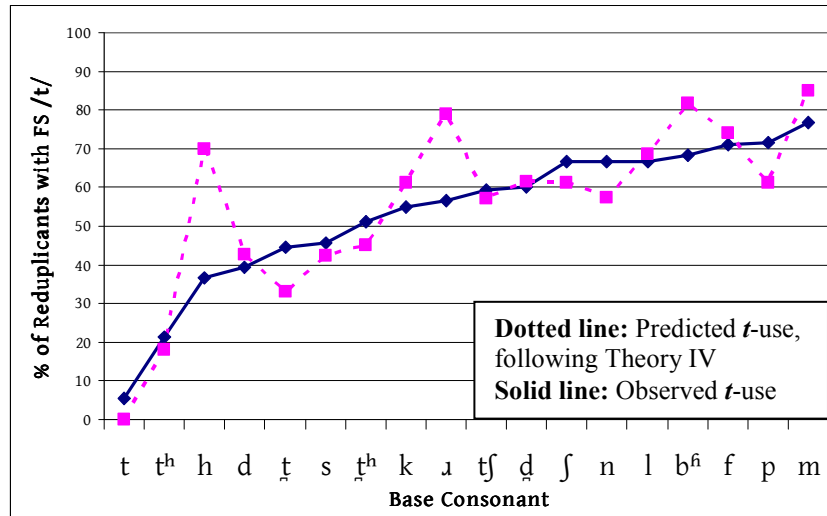

**Figure 5.** Fixed segment /t/-use in reduplicants as predicted by Theory IV/feature weighting (dotted) versus observed data (solid).

#### 4 Summary

| Theory                            | Derives from      | Free parameters            | Correlation with data      |
|-----------------------------------|-------------------|----------------------------|----------------------------|
| I. Lexical cooccur. restrict.     | Lexicon           | none                       | $r^2 = .004$<br>$p = 0.81$ |
| II. Shared natural classes metric | Phoneme inventory | none                       | $r^2 = .584$<br>$p < 0.01$ |
| III. Relativized OCP, as adapted  | ?                 | feature subsets            | $r^2 = .717$<br>$p < 0.01$ |
| IV. Feature weighting             | ?<br>(see below)  | ft. weights<br>(see below) | $r^2 = .855$<br>$p < 0.01$ |

**Table 1.** Summary of the comparison of four theories of similarity.

The lack of correlation between lexical cooccurrence restrictions and /t/-use in reduplicants [ $r^2 = .004$ ] confirms that speakers do not judge similarity based on cooccurrence patterns in their lexicon. The correlation between shared natural classes and /t/-use in reduplicants [ $r^2 = .584$ ] is substantial, but the model cannot describe the relative similarity of the coronal consonants to /t/. And while the data can be closely predicted by positing relativized OCP constraints [ $r^2 = .717$ ], this requires the use of eight constraints that have no basis in the lexicon, and

make no predictions about similarity phenomena in other languages. It is unclear how speakers could acquire a grammar involving these relativized OCP constraints from independent sources. The theory that best fits the data [ $r^2 = .855$ ] is one in which similarity is judged based on universal features assigned different weights. Of course, in addition to being the closest matches to the observed patterns, the predictions of both Theory III/relativized OCP constraints and Theory IV/feature weighting were made to fit to the experimental data. Section 5 provides a discussion of one possible hypothesis supporting the theory that most closely matches the data (*i.e.* Theory IV/feature weighting).

### 5 Feature weights: a function of contrast?

The results of Theory IV bring up further questions: if similarity is judged by assigning different weights to different features, where could these weights come from? Weights could be either universal (Melnar & Liu 2006) or language-specific. If they are universal, we would predict that all languages would pattern with East Bengali and weight [voice], [distributed], [strident], and [spread glottis] above other features. This is unlikely, as many languages do not make contrasts using these features, unlike East Bengali.

Feature weights are more likely language-specific, possibly reflecting the relative importance of the feature in contrasting the language's phonemes. This hypothesis would predict that the better a feature is at contrasting the phonemes in a given language, the heavier its weight will be in that language. Thus, feature weights can serve as a function of contrast.

Consider the four features weighted more heavily than others in East Bengali echo reduplication: [voice], [distributed], [strident], and [spread glottis]. These four features alone can distinguish all 15 coronal obstruents from one another in East Bengali, and thus presumably carry significant practical import in terms of contrast in a language with such a coronal-heavy inventory.

|           | Dental                        | Alveolar                      | Post-alveolar                               |
|-----------|-------------------------------|-------------------------------|---------------------------------------------|
| Plosive   | ṭ    ḍ                      | t    d                        |                                             |
|           | t <sup>h</sup> d <sup>h</sup> | t <sup>h</sup> d <sup>h</sup> |                                             |
| Affricate |                               |                               | tʃ    dʒ<br>tʃ <sup>h</sup> dʒ <sup>h</sup> |
| Fricative |                               | s    z                        | ʃ                                           |

**Table 2.** The coronal obstruents of East Bengali.

Given the relatively crowded articulatory space occupied by these 15 obstruents, it is reasonable to postulate that speakers of such a language stretch the perceptual space between those phonemes (Kuhl 1991, Kuhl 2000, Iverson *et al.* 2003) by amplifying the importance of each relevant feature. If this data is representative of a larger pattern, we can predict that while phonetic features are universally available, they have language-specific weights derived from the phoneme inventory, with each weight corresponding to the capacity of each feature to make phonemic contrasts. For example, since the feature [voice] alone distinguishes ten pairs of consonants – more than any other feature in the language – it is not surprising that it is assigned the heaviest weight in the language ( $w = 0.554$ ). Under this hypothesis, speakers acquire the feature weights of their language once they acquire the full phonemic inventory, and are then equipped to make similarity judgments in the productive grammar.

## 6 Conclusion

Numerous measurements of similarity have been proposed for a variety of languages and processes, making reference to the lexicon, universal features, and OT constraints. Four theories of similarity were tested against data collected in an experiment studying a productive similarity avoidance alternation (*i.e.* East Bengali echo reduplication). The theory that best matched the observed data involved feature weighting: speakers measure the similarity of consonants by referring to the features they share, counting certain features as having heavier weights. One hypothesis on the source of these weights involves the concept of contrast: a feature's weight is determined by its ability to contrast phonemes in the inventory. This suggests that similarity is measured using universally-available features assigned weights reflecting their relative effectiveness in contrasting the phonemes in the inventory. Data from productive similarity avoidance alternations in several languages will be needed to test this further.

---

## Notes

1 I would especially like to thank my M.A. thesis advisors, Kie Ross Zuraw, Colin Wilson (also my programming and statistics consultant), and Bruce Hayes; my native speaker consultant, Farida Amin Khan; the UCLA Phonology Seminar; and the 30 subjects of my study.

2 All examples shown in the current study were collected in the experiment described in Section 2.

3 All fixed segments are shown in **boldface** to distinguish them from surrounding material.

4 See Khan (2006) for a full list of all stimuli used in the experiment described in Section 2.

5 Bengali is an Indo-European language spoken by over 171 million people in South Asia (Gordon 2005). Based on the dialect of towns near Dhaka, East Bengali is widely understood by speakers of other Bangladeshi dialects, although Standard Bengali is the only form used in schools or the media.

6 Introduced in Pierrehumbert (1993); equation copied from Frisch, *et al.* (2004), example (7).

7 The feature values used in the current study are drawn from Hayes (2001), and represent the acoustic, articulatory (palatographic), and phonological data on a variety of Bengali spoken in Dhaka, Bangladesh, as presented in Hai (1960). See Khan (2006) for a table of feature values used.

8 This is the closest match between the relativized OCP theory and observed /t/-use. The ranking was derived as follows: since /t<sup>h</sup>/ is the second-most similar consonant to /t/ (after /t/ itself) in terms of /t/-use, the second highest-ranked constraint differs from the highest-ranked constraint in the loss of the feature [s.g.] (*i.e.* the feature contrasting /t/ and /t<sup>h</sup>/). Since the next most similar consonant to /t/ is /d/, the feature removed from the next constraint in the hierarchy is [voice], and so on.

9 The similarity of a consonant C and /t/ is calculated in the feature weighting metric using the following binomial formula:

$$P = ((m!) \div (n!(m-n)!)) (1 - \text{sim}(C, /t/))^n (\text{sim}(C, /t/))^{m-n}$$

**Where**  $P$  is the probability that base-initial  $C$  will cooccur with FS /t/  $n$  times out of  $m$  trials

**Where**  $\text{sim}(C, t)$  was calculated as:

$$\text{sim}(C, t) = \exp(-\sum_{i=1}^{\# \text{ features}} w_i (1 - \delta_i(C, /t/)))$$

**Where**  $\delta_i(C, /t/) = 1$  if  $C$  and /t/ agree on feature  $i$

$$\begin{aligned} \therefore \delta_i(C, /t/) &= 0 \text{ otherwise} \\ -\delta_i(C, /t/) &= 0 \text{ if } C \text{ and } /t/ \text{ agree on feature } i \\ -\delta_i(C, /t/) &= 1 \text{ otherwise} \end{aligned}$$

$$\begin{aligned} \therefore w_i \delta_i(C, /t/) &= 0 \text{ if } C \text{ and } /t/ \text{ agree on feature } i \\ w_i \delta_i(C, /t/) &= w_i \text{ otherwise} \end{aligned}$$

$$\begin{aligned} \therefore \sum_{i=1}^{\# \text{ features}} w_i (1 - \delta_i(C, /t/)) &= \text{sum of weights of features that distinguish } C \text{ and } /t/ \\ \therefore 0 \leq \text{sim}(C, /t/) &\leq 1 \end{aligned}$$

**Where**  $\text{sim}(C, t) = 1 = \exp(-0)$  if  $C$  and /t/ are featurally identical  
 $\text{sim}(C, t) < 1$  if  $C$  and /t/ differ featurally

## References

- Bailey, Todd M. & Ulrike Hahn. 2005. 'Phoneme similarity and confusability', *Journal of Memory and Language*, **52**.
- Berkley, Deborah. 1994. 'The OCP and gradient data', *Studies in the Linguistic Sciences*, **24**. 59-72.
- Coetzee, Andries & Joe Pater. 2005. 'Gradient phonotactics in Muna and Optimality Theory', University of Michigan & University of Massachusetts – Amherst.

- 
- Frisch, Stefan. 1996. 'Similarity and frequency in phonology', Unpublished Ph.D. thesis, Northwestern University.
- Frisch, Stefan, Janet Pierrehumbert, & Michael Broe. 2004. 'Similarity Avoidance and the OCP', *Natural Language and Linguistic Theory*, **22**.
- Gordon, Raymond G., Jr. (ed.). 2005. *Ethnologue: Languages of the World*, Fifteenth edition. Dallas, Tex.: SIL International. Online version: [www.ethnologue.com](http://www.ethnologue.com).
- Hai, Muhammad Abdul. 1960. *A Phonetic and Phonological Study of Nasals and Nasalization in Bengali*. Dacca, East Pakistan: Dacca University Press [now Dhaka, Bangladesh: Dhaka University Press].
- Hayes, Bruce. 2001. *Introductory Phonology*. Unpublished textbook. UCLA.
- Herd, Jonathon. 2005. 'Loanword adaptation and the evaluation of similarity', *Toronto Working Papers in Linguistics*, **24**.
- Iverson, Paul, Patricia K. Kuhl, Reiko Akahane-Yamada, Eugen Diesch, Yoh'ich Tohkura, Andread Kettermann, & Claudia Siebert. 2003. 'A perceptual interference account of acquisition difficulties for non-native phonemes', *Cognition*, **87**. 1: B47–57.
- Khan, Sameer ud Dowla. 2006. 'Similarity Avoidance in East Bengali Fixed-Segment Reduplication', Presented at the Western Conference on Linguistics, Fresno, CA, Ms. Online version: <http://www.linguistics.ucla.edu/people/grads/sameer/publications.html>.
- Kuhl, Patricia K. 1991. 'Human adults and human infants show a "perceptual magnet effect" for the prototypes of speech categories, monkeys do not', *Perception & Psychophysics*, **50**. 93-107.
- Kuhl Patricia K. 2000. 'Language, mind, and the brain: Experience alters perception', *The New Cognitive Neurosciences*, ed. M. S. Gazzaniga. Cambridge, MA: MIT Press. 99–115.
- Ladefoged, Peter. 1969. 'The measurement of phonetic similarity', *Proceedings of the conference on Computational linguistics*, Sång Saby, Sweden.
- Mackenzie, Sara. 2005. 'Similarity and Contrast in Consonant Harmony Systems', *Toronto Working Papers in Linguistics*, **24**.
- Mallik, Bhakti Prasad, Nikhilesh Bhattacharya, Subhas Chandra Kundu, and Mina Dawn. 1998. *The Phonemic and Morphemic Frequencies of the Bengali Language*. Kolkata, India: The Asiatic Society.
- McCarthy, John J. 1986. 'OCP Effects: Gemination and Antigemination', *Linguistic Inquiry* **17**.

- 
- McCarthy, John, & Alan Prince. 1986. 'Prosodic Morphology', Ms., University of Massachusetts – Amherst & Brandeis University.
- Melnar, Lynette & Chen Liu. 2006. 'A Combined Phonetic-Phonological Approach to Estimating Cross-Language Phoneme Similarity in an ASR Environment', *Proceedings of the Eighth Meeting of the ACL Special Interest Group on Computational Phonology at HLT-NAACL 2006*. New York: Association for Computational Linguistics. 1-10.
- Nevins, Andrew & Michael Wagner. 2001. 'Backcopying, Shmackcopying: Correspondence Relations and Dissimilation in Echo Reduplication', Presented at the LOT Summer School, Nijmegen. Ms.
- Pierrehumbert, Janet B. 1993. 'Dissimilarity in the Arabic Verbal Roots', *Proceedings of the North East Linguistics Society*, **23**. 367–381.
- Prince, Alan & Paul Smolensky. 1993. 'Optimality theory: Constraint interaction in generative grammar', Ms. Rutgers University and University of Colorado, Boulder.
- R Development Core Team. 2005. R: A language and environment for statistical computing. R Foundation for Statistical Computing, Vienna, Austria. <http://www.R-project.org>.
- Rose, Sharon & Rachel Walker. 2004. 'A typology of consonant agreement as correspondence', *Language*, **80**.
- Zuraw, Kie. Similar.exe. Software program.

Sameer ud Dowla Khan  
UCLA Department of Linguistics  
3125 Campbell Hall  
Los Angeles, CA 90095  
[sameer@humnet.ucla.edu](mailto:sameer@humnet.ucla.edu)

# Agreement in Icelandic: An Argument for Derivational Theory of Intervention Effects

Ivona Kučerová

MIT

Some recent work has argued from Icelandic agreement patterns that agreement is essentially non-derivational, and involves non-trivial calculations of locality (Chomsky 2001, 2004, 2005; Hiraiwa 2005).<sup>1</sup> Based on new data from Icelandic, I show that the availability of agreement with a Nominative object is in fact restricted by simple locality and has a crucially derivational character. The relevant locality condition must hold at some point in the derivation and is simple in that it does not assume extension or contraction of the relevant probing domain, unlike proposals that explain the apparent optionality of agreement in bi-clausal environments by appealing to optional restructuring (Boeckx 2004; Nomura 2005; Bhatt 2003; Bobaljik 2006). More concretely, I argue that Dative intervention effects in Icelandic depend on whether the potential intervener undergoes object shift or it does not. I argue that the locus of agreement is *v*, whose unvalued  $\phi$ -features act as a probe. If the potential intervener undergoes object shift, *v* is free to probe the Nominative object. If object shift is blocked, the intervener is closer to the probing head than the Nominative object and the intervention effect arises.

## 1 Puzzle

An Icelandic finite verb agrees with a Nominative argument, even if the argument is an object (1). The Nominative object agreement is obligatory in a mono-clausal environment but optional in a bi-clausal environment (2).

- (1) það voru konugi gefnar ambáttir í vettur.  
EXPL **were.pl** king.Dat given *slaves.Nom* in winter  
'A king was given female slaves in winter.'
- (2) a. Einhverjum stúdent finnst tölvurnar ljótar.  
some student.Dat **finds.sg** *the-computers.Nom* ugly.Nom  
b. Einhverjum stúdent finnast tölvurnar ljótar.  
some student.Dat **find.pl** *the-computers.Nom* ugly.Nom  
'Some student finds the computers ugly.'



If a Dative DP (DAT) ('experiencer') linearly intervenes between the finite verb and the Nominative object, agreement is still obligatory in a mono-clausal environment (1) but blocked in a bi-clausal environment (3) (Watanabe 1993; Taraldsen 1995; Schütze 1997). Surprisingly, Holmberg and Hróarsdóttir (2003) argued that some DAT are transparent for nominative object agreement (NOA) (4).

This paper addresses two basic questions: (i) what is the difference between Dative arguments that block NOA and Dative arguments that are transparent for NOA, and (ii) why the difference arises only in bi-clausal environments. I will call the Datives that are opaque for NOA the O(paque)-Dat and those that are transparent the T(ransparent)-Dat (5).

- (3) a. Það virðist einhverjum manni hestarnir vera  
EXPL **seems.sg** *some* *man.Dat* the-horses.Nom be  
seinir.  
slow.Nom
- b. \*Það virðast einhverjum manni hestarnir vera seinir.  
EXPL **seem.pl** *some* *man.Dat* the-horses.Nom be slow.Nom  
'A man finds the horses slow.'
- (4) a. Það finnst mörgum stúdentum tölvurnar  
EXPL **finds.sg** *many* *students.Dat* the-computers.Nom  
ljótar.  
ugly.NOm
- b. Það finnast mörgum stúdentum tölvurnar ljótar.  
EXPL **find.pl** *many* *students.Dat* the-computers.Nom ugly.Nom  
'Many students find the computers ugly.'
- (5) a. \*V O-Dat Nom  
└───┬───┘  
↑
- b. V T-Dat Nom  
└───┬───┘  
↑

I will provide an argument that (5a) and (5b) correspond to different syntactic structures. Opaque datives can never undergo Object shift, (5a). Therefore they always stay below *v* and intervene between the probing head and the Nominative object. In contrast, transparent datives may undergo Object shift, (5b). If they undergo object shift, i.e., if they raise above *v*, the phase head is free to probe the Nominative object. In case the DAT does not undergo object shift, the DAT behaves as an intervener and default agreement is established. The corresponding syntactic structures are schematized in (6) and (7). It follows that the  $\phi$ -features that probe for Nominative are located on *v*. If  $\phi$ -features were located on *T*, the difference in the syntactic position of opaque and transparent datives would be irrelevant for probing since in both structures the Dative would intervene between *T* and the Nominative object. I thus assume that *T* inherits features from *v*. Thus *T*

does not behave as the probe (contrary Chomsky 2005; Nomura 2005 and others). I argue, following Bobaljik (2006), that agreement is a postsyntactic operation and as such is sensitive to the post-spell-out configuration at the phase level, i.e., *vP*-level.

- (6) Opaque Dative does not undergo OS (5a):

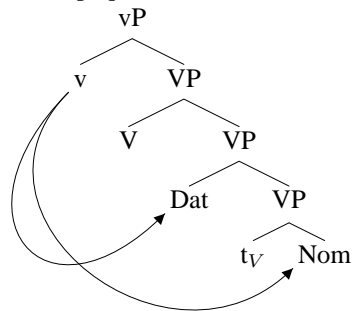

- (7) Transparent Dative undergoes OS (5b):

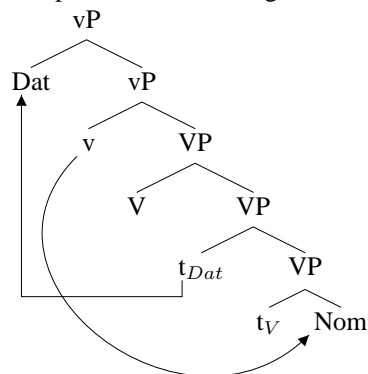

Before I approach to the actual analysis, I will briefly review the basics of predicate agreement in Icelandic. In Icelandic there is no direct correspondence between a structural position and Case. A Nominative argument can be either the subject (8a), or an object (8b). Similarly, a Dative argument can be either an object (9a), or the subject (9b). For arguments that non-Nominative (quirky) subjects are indeed subjects see Zaenen et al. (1985) and Sigurðsson (1992). The arguments are based for example on their behavior within ECM, in reflexivization, subject-verb inversion, and raising to subject. For arguments that Nominative objects are indeed objects see Harley (1995) and Jónsson (1996) (in short, Nominative objects fail in the subject-hood tests and can undergo object shift).

- (8) a. Ég hafði séð hana.  
I.Nom had seen her.Acc  
'I had seen her.'
- b. Henni þykir Ólafur leiðinlegur.  
her.Dat thinks Olaf.Nom boring.Nom  
'She finds Olaf boring.'
- (9) a. Ég hjálpaði honum.  
I.Nom helped him.Dat  
'I helped him.'
- b. Henni þykir Ólafur leiðinlegur.  
her.Dat thinks Olaf.Nom boring.Nom  
'She finds Olaf boring.'

Predicate agreement is sensitive to Case, i.e., agreement is always with Nominative. As can be seen in (10) the verb agrees with the Nominative argument in both Number and Gender. Agreement with a Nominative argument is obligatory even if the subject is Dative, as in (11). Notice that the actual position of the Dative argument is irrelevant for agreement. If there is no Nominative, default agreement emerges (default in both Number and Gender) (12).

- (10) a. Ólafur var farinn til Íslands.  
Olaf.Nom.M was gone.M.sg to Iceland.G
- b. Sigga var farin til Íslands.  
Sigga.Nom.F was gone.F.sg to Iceland.G
- c. Barnið var farið til Íslands.  
the-child.Nom.N was gone.N.sg to Iceland.G
- (11) a. Jóni líkuðu þessir sokkar.  
*Jon.Dat liked.pl* these socks.Nom  
'Jon liked these socks.'
- b. Það líkuðu einhverjum þessir sokkar.  
EXPL *liked.pl* *someone.Dat* these socks.Nom  
'Someone liked these socks.'
- c. Það voru konugi gefnar ambáttir í vettur.  
EXPL *were.pl* *king.Dat* given slaves.Nom in winter  
'There was a king given maidservants this winter.'
- (12) Stelpunum var hjálpað.  
the-girls.Dat.F.pl was.3.sg helped.N.sg.  
'The girls were helped.'

There is a lot of variation among Icelandic speakers with respect to agreement (there are differences between rural and urban areas, and generational differences; Dianne Jonas, p.c.). The judgments reported in this paper are exclusively from

young Icelanders (20–24 years) from Reykjavík. I have taken into account only data from those speakers who share the contrast reported in (5).

## 2 Nominative Object Agreement and Object Shift

As we have seen in (2), repeated below as (13), if no argument intervenes between the finite verb and the Nominative object, Nominative object agreement (NOA) in a bi-clausal environment is *optional*. In contrast, if there is a Dative argument linearly intervening between the finite verb, NOA is (sometimes) *blocked* (Watanabe, 1993; Schütze, 1997) (14). Crucially, some Dative arguments appeared to be *transparent* for NOA (Holmberg and Hróarsdóttir, 2003) (15).

- (13) a. Einhverjum stúdent finnst tölvurnar ljótar.  
*some student.Dat finds.sg the-computers.Nom ugly.Nom*  
 b. Einhverjum stúdent finnast tölvurnar ljótar.  
*some student.Dat find.pl the-computers.Nom ugly.Nom*  
 ‘Some student finds the computers ugly.’
- (14) a. Það virðist einhverjum manni hestarnir vera  
 EXPL **seems.sg** *some man.Dat the-horses.Nom* be  
 seinir.  
 slow.Nom  
 b. \*Það virðast einhverjum manni hestarnir vera  
 EXPL **seem.pl** *some man.Dat the-horses.Nom* be  
 seinir.  
 slow.Nom  
 ‘A man finds the horses slow.’
- (15) a. Það finnst mörgum stúdentum tölvurnar  
 EXPL **finds.sg** *many students.Dat the-computers.Nom*  
 ljótar.  
 ugly.Nom  
 b. Það finnast mörgum stúdentum tölvurnar ljótar.  
 EXPL **find.pl** *many students.Dat the-computers.Nom* ugly.Nom  
 ‘Many students find the computers ugly.’

Based on these facts, Holmberg and Hróarsdóttir 2003 concluded that NOA is conditioned by feature values of the intervening Dative. According to them, a Dative argument is transparent for NOA only if the Dative and the Nominative object share the same  $\phi$ -features. In the rest of this section I will argue that this generalization is empirically incorrect, and I will propose a different generalization.

## 2.1 New generalization

Since Holmberg and Hróarsdóttir 2003 condition the distribution of NOA by  $\phi$ -feature values of the relevant argument, they predict the following distribution of agreement in Icelandic:

- (16)
- a. EXPL  $V_{sg}$   $Dat_{sg}$   $Nom_{sg}$
  - b. \*EXPL  $V_{pl}$   $Dat_{sg}$   $Nom_{sg}$
  - c. EXPL  $V_{sg}$   $Dat_{pl}$   $Nom_{sg}$
  - d. \*EXPL  $V_{pl}$   $Dat_{pl}$   $Nom_{sg}$
  - e. EXPL  $V_{sg}$   $Dat_{sg}$   $Nom_{pl}$
  - f. \*EXPL  $V_{pl}$   $Dat_{sg}$   $Nom_{pl}$
  - g. EXPL  $V_{sg}$   $Dat_{pl}$   $Nom_{pl}$
  - h. **EXPL  $V_{pl}$   $Dat_{pl}$   $Nom_{pl}$**

The most relevant configuration is that one given in (16h). The other grammatical configurations cannot be tested because they are ambiguous between a default agreement and NOA. All things being equal, the prediction is clear: any plural Dative should be equally transparent for NOA. However, this is not what we find. Speakers who perceive a contrast between (14) and (15) do not find NOA across certain other plural Datives equally good, as can be seen in (17–18).

- (17)
- a. Það finnst fáum börnum tölvurnar ljótar.  
EXPL **find.sg.** *few children.Dat.pl* computer.D.Nom.pl ugly
  - b. \*Það finnast fáum börnum tölvurnar ljótar.  
EXPL **find.pl** *few children.Dat.pl* computer.D.Nom.pl ugly  
'There are few children that find the computers ugly.'
- (18)
- a. Það finnst báðum köttumum mýsnar góðar.  
EXPL **find.sg.** *both cats-the.Dat* mice-the.Nom tasty
  - b. \*Það finnast báðum köttumum mýsnar góðar.  
EXPL **find.pl** *both cats-the.Dat* mice-the.Nom tasty  
'Both the cats find the mice tasty.'

I argue instead for a new generalization given in (19).<sup>2</sup> The table in (20) gives a list of DPs depending on their behavior with respect to NOA and their ability to undergo object shift. As can be seen from the table, the two properties fully coincide.

(19) **New generalization:**

A Dative argument is transparent for NOA only if the Dative DP can independently undergo Object shift (OS, Holmberg (1986); Thráinsson (2001)).

(20) **Correlation between NOA and object shift:**

| Quantifier     | Is NOA possible? | Is OS possible? |
|----------------|------------------|-----------------|
| almost all     | no               | no              |
| few            | no               | no              |
| all            | no               | no              |
| both the       | no               | no              |
| almost all the | no               | no              |
| each           | no               | no              |
| many           | yes              | yes             |
| three          | yes              | yes             |
| exactly three  | yes              | yes             |
| few of the     | yes              | yes             |
| some pl        | yes              | yes             |

To decide whether a DP can or cannot undergo object shift, I tested its behavior with respect to negation. It is known that Icelandic allows object shift of full DPs, i.e., an object can either precede, or follow negation (21). As can be seen in (22–23), DPs that are opaque for NOA cannot precede negation, thus, they cannot independently undergo OS. In contrast, DPs that are transparent for NOA can independently undergo OS, as seen in (24–25).

- (21) a. Nemandinn las *ekki* **bókina**.  
student-the read not book-the  
b. Nemandinn las **bókina<sub>i</sub>** *ekki*  $t_i$ .  
student-the read book-the not  
'The student didn't read the book.'
- (22) few  
a. Mýs elska *ekki* **fáa ketti**.  
mice love not few cats  
b. \*Mýs elska **fáa ketti** *ekki*.  
mice love few cats not  
'Mice do not love few cats.'
- (23) each  
a. Mýsnar elska *ekki* **hvern kött**.  
mice love not each cat  
b. \*Mýsnar elska **hvern kött** *ekki*.  
mice love each cat not  
'The mice do not love each cat.'

- (24) exactly three
- a. Mýsnar elska *ekki* **akkúrat þrjá ketti**.  
mice-the love not exactly three cats
- b. Mýsnar elska **akkúrat þrjá ketti** *ekki*.  
mice-the love exactly three cats not  
'The mice do not love exactly three cats.'
- (25) few of the
- a. Mýsnar elska *ekki* **nokkra ketti**.  
mice-the love not few-of-the cats
- b. Mýsnar elska **nokkra ketti** *ekki*.  
mice-the love few-of-the cats not  
'The mice do not love few of the cats.'

I assume that object shift is A-movement (i.e., syntactic operation) that targets a specifier of *vP* (contra for example, Holmberg (1999); Nilsen (2003); Fox and Pesetsky (2005)). I argue that  $\phi$ -features that act as a probe for agreement are located on *v* (cf. Boeckx (2004); Pesetsky and Torrego (2004) for ideas in a similar direction). If  $\phi$ -features were located on *T*, the difference in the syntactic position of opaque and transparent datives would be irrelevant for probing since in both structures the Dative would intervene between *T* and the Nominative object. Thus, if a Dative DP undergoes object shift, in the end of *vP*-phase, this DP is structurally higher than the probing phasal head. The structure that arise is thus as given in (26–27), repeated here from (6–7).

I argue that this agreement pattern provides an argument for a strictly derivational concept of agreement. Since object shift is possible only if the finite verb moves further to *T/C*, the relevant configuration, i.e. the configuration where there is a difference between a DP that undergoes object shift and a DP that does not, is valid only on the *vP*-level and it gets undone in the next phase once the finite verb moves further.

- (26) Derivation I (Dative undergoes OS):

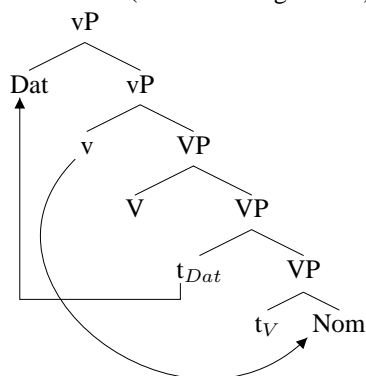

(27) Derivation II (Dative does not undergo OS):

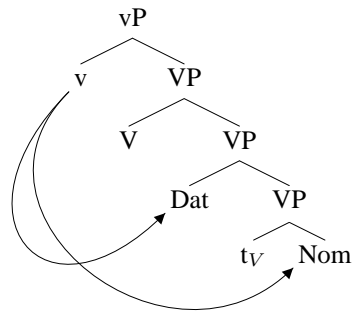

The question that arises is how come these two differing structural configurations are available only in a bi-clausal environment. I argue that the difference between mono-clausal and bi-clausal environments lie in the position where a Dative argument is base generated. I must assume that propositional predicates like *seem*, i.e., the only predicates that show NOA in a bi-clausal environment, do not have any external argument. Dative is an internal argument of VP (cf. Larson (1988); Hale and Keyser (2002)). Dative is generated as an ‘experiencer’, i.e., the individual with respect to whom beliefs expressed by the propositional predicate are evaluated. In contrast, a Dative in a mono-clausal environment is an external argument. As such, it is either merged at Spec,vP, or it obligatorily moves there (cf. Bobaljik and Jonas (1996) on heights of Icelandic subjects). As a result, in the end of *vP*-phase, when I argue agreement takes place, the Dative argument is never in the probing domain of *v* and therefore it can never behave as an intervener for NOA (28).

(28)

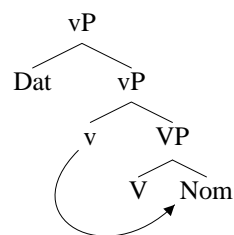



## 2.2 Predictions

According to the new generalization given in (19) NOA is crucially dependent on object shift. Thus it should not be available if object shift is independently blocked. Since object shift (Holmberg, 1986, 1999) can move across an adverb, NOA should be optional only if object shift is string vacuous. Whenever, there is an adverb, agreement should be disambiguated. The first prediction is that NOA should not be available if there is a low adverb intervening between the finite verb and the Dative argument. As can be seen in (29–30), this prediction is borne out.

- (29) three
- a. Það finnst alltaf þremur börnum  
EXPL **find.sg** ALWAYS *three children.Dat.pl*  
tölvurnar ljótar.  
computer.D.Nom.pl ugly
- b. Það finnast (\*alltaf) þremur börnum  
EXPL **find.pl** ALWAYS *three children.Dat.pl*  
tölvurnar ljótar.  
computer.D.Nom.pl ugly
- ‘Three children always find the computers ugly.’
- (30) many
- a. Það finnst fljótt mörgum köttum mýsna góðar.  
EXPL **finds.sg** QUICKLY *many cats.Dat.pl* the-mice tasty
- b. Það finnast (??/\* fljótt) mörgum köttum mýsna góðar.  
EXPL **find.pl** QUICKLY *many cats.Dat.pl* the-mice  
góðar.  
tasty
- ‘Many cats find quickly the mice tasty.’

It follows that if a Dative argument precedes a low adverb, i.e., if the Dative under-vent non-string vacuous OS, NOA is expected to be obligatory. This prediction is borne out as well, as can be seen in (31).

- (31) a. Það finnst mörgum köttum (??/\* fljótt) mýsna góðar.  
EXPL **finds.sg** *many cats.Dat.pl* QUICKLY the-mice  
góðar.  
tasty
- b. Það finnast mörgum köttum fljótt mýsna góðar.  
EXPL **find.pl** *many cats.Dat.pl* QUICKLY the-mice tasty
- ‘Many mice find quickly the mice tasty.’

Another relevant property of object shift is that it has an interpretive effect (Diesing and Jelinek (1995); Diesing (1992); Thráinsson (2001)). As can be seen in (32–33), the interpretation differs depending on whether the relevant DP underwent object shift or it did not.

- (32) Icelandic:
- a. Nemandinn las *ekki þrjár bækur*.  
the-student read not three books  
'It is not the case that the student read three books.'
  - b. Nemandinn las *þrjár bækur ekki*.  
the-student read three books not  
'There are three books that the students didn't read.'
- (33) German:
- a. ... weil ich *selten jedes Cello* spiele.  
since I seldom every cello play  
'It is rarely the case that I play every cello.'
  - b. ... weil ich *jedes Cello selten* spiele.  
since I every cello seldom play  
'It holds for every cello that I rarely play it.'

If NOA optionality comes from the presence or the absence of object shift, we expect that agreement patterns should have an interpretive effect. As can be seen in (34), this is indeed correct. Informally, for a speaker to accept NOA in these constructions, the Dative DP must denote a set of known/given objects. In a scenario where the set of object denoted by the Dative arguments cannot be uniquely determined speakers do not accept NOA and prefer default agreement.

- (34) a. Það finnst mörgum stúdentum tölvurnar  
EXPL **finds.sg** many students.Dat the-computers.Nom  
ljótar.  
ugly.NOm  
→ In general, many students find the computers ugly.
- b. Það finnast mörgum stúdentum tölvurnar ljótar.  
EXPL **find.pl** many students.Dat the-computers.Nom ugly.Nom  
→ There are many students – and I know who they are – who find the computers ugly.

To conclude, I have presented a new generalization on Icelandic Nominative object agreement across a Dative argument. I have argued that a Dative in Icelandic intervenes only if it cannot undergo object shift. If a Dative DP undergoes object shift, it can avoid a relativized minimality violation by being higher than the relevant probing head. I have also argued that the relevant probing head is *v*. *T/C* does not behave as a probe. It can only inherit  $\phi$ -feature from *v*.

## Notes

<sup>1</sup>I would like to thank the following people for discussing with me issues related to this paper: Danny Fox, Sabine Iatridou, Martina Gračanin Yuksek, Roni Katzir, Alec Marantz, David Pesetsky, and Susi Wurmbrand. Special thanks go to my ever patient informants, especially to María Ágústisdóttir. All remaining mistakes are of course solely mine.

<sup>2</sup>This generalization is not easy to test because the set of Dative DPs that can occur in a transitive expletive construction is restricted (e.g., Vangsnes (2002) and references cited herein). Most DPs must be fronted but they cannot stay between the finite verb and the Nominative object, as seen below.

- (35) \*Það finnst börnum/börnunum/Páli tölvurnar ljótar.  
EXPL finds **children.Dat/the-children.Dat/Paul.Dat** the-computers.Nom ugly.Nom  
'Children/The children/Paul find the computers ugly.'
- (36) Börnum/börnunum/Páli finnst tölvurnar ljótar.  
**children.Dat/the-children.Dat/Paul.Dat** finds the-computers.Nom ugly.Nom  
'Children/The children/Paul find the computers ugly.'

This empirical restriction makes it difficult to test the full range of the new generalization. I have not found any singular DP that would be allowed between the finite verb and the Nominative object and that would be in the same time able to undergo object shift. Thus, I lack a direct evidence that Number of the Dative intervener is irrelevant for NOA.

## References

- Bhatt, Rajesh. 2003. Long-distance agreement in Hindi-Urdu. [University of Texas at Austin, Ms.].
- Bobaljik, Jonathan David. 2006. Where's  $\phi$ ? Agreement as a post-syntactic operation. [UConn, Ms.].
- Bobaljik, Jonathan David, and Dianne Jonas. 1996. Subject positions and the roles of TP. *Linguistic Inquiry* 27:195–236.
- Boeckx, Cedric. 2004. Long-distance agreement in Hindi: Some theoretical implications. *Studia linguistica* 58:23–36.
- Chomsky, Noam. 2005. On phases. MIT ms.
- Diesing, Molly. 1992. *Indefinites*. Cambridge, Mass.: MIT Press.
- Diesing, Molly, and Eloise Jelinek. 1995. Distributing arguments. *Natural Language Semantics* 3:123–176.
- Fox, Danny, and David Pesetsky. 2005. Cyclic linearization of syntactic structure. *Theoretical Linguistics* 31:1–45.
- Hale, Ken, and Samuel Jay Keyser. 2002. *Prelogomenon to a theory of argument structure*. Cambridge, Mass.: MIT Press.
- Harley, Heidi. 1995. Abstracting away from abstract case. In *Proceedings of the North Eastern Linguistics Society Annual Meeting (NESL25)*, 207–221. Amherst, MA: University of Massachusetts, GLSA.
- Holmberg, Anders. 1986. Word order and syntactic features. Doctoral Dissertation, University of Stockholm.

- Holmberg, Anders. 1999. Remarks on Holmberg's Generalization. *Studia Linguistica* 53:1–39.
- Holmberg, Anders, and Thorbjörg Hróarsdóttir. 2003. Agreement and movement in Icelandic raising constructions. *Lingua* 113.
- Jónsson, Jóhannes Gísli. 1996. Clausal architecture and case in Icelandic. Doctoral Dissertation, University of Massachusetts at Amherst.
- Larson, Richard. 1988. On the double object construction. *Linguistic Inquiry* 19:335–391.
- Nilsen, Østein. 2003. Eliminating positions: Syntax and semantics of sentence modification. Doctoral Dissertation, University of Utrecht.
- Nomura, Masashi. 2005. Nominative Case and AGREEMENT. Doctoral Dissertation, University of Connecticut.
- Pesetsky, David, and Esther Torrego. 2004. The syntax of valuation and the interpretability of features. Ms.
- Schütze, Carson Theodore Robert. 1997. Syncretism and double agreement with Icelandic Nominative objects. In *Grammar in focus: Festschrift for Christer Platzak 18 November 2003*, ed. Lars-Olof Delsing, Cecilia Falk, Gunlög Josefsson, and Halldór Ármann Sigurðsson, volume 2, 295–303. Lund.
- Sigurðsson, Halldór Ármann. 1992. The case of quirky subjects. *Working Papers in Scandinavian syntax* 49:1–26.
- Taraldsen, Knut Tarald. 1995. On agreement and nominative objects in Icelandic. In *Studies in comparative Germanic syntax*, ed. Hubert Haider, Susan Olsen, and Sten Vikner. Dordrecht: Kluwer.
- Thráinsson, Höskuldur. 2001. Object shift and scrambling. In *A handbook of contemporary syntactic theory*, ed. Mark Baltin et al. New York: Blackwell.
- Vangsnæs, Østein Alexander. 2002. Icelandic expletive constructions and the distribution of subject types. In *Subjects, expletives, and the EPP*, ed. Peter Svenonius. Oxford University Press.
- Watanabe, Akira. 1993. Larsonian CP recursion, factive complements, and selection. In *Proceedings of NELS XXIII*, ed. Amy J. Schafer, 523–537. University of Massachusetts: GLSA.
- Zaenen, Annie, Joan Maling, and Höskuldur Thráinsson. 1985. Case and grammatical functions: The Icelandic passive. *Natural language and linguistic theory* 3:441–483.

Ivona Kučerová  
 Department of Linguistics and Philosophy  
 MIT  
 kucerova@mit.edu

# Does the Causing Component of a Resultative Have to Involve an Activity?<sup>1</sup>

Chao Li

Yale University

## 1. Introduction

A number of linguists (e.g. Giannakidou & Merchant 1999: 94, Li 1994: 352, Nakamura 1997: 498, Pustejovsky 1991: 65, Rapoport 1990: 40, Rothstein 2004: 83, Tai 1984: 290, Wechsler 1997: 308) claim that only process or activity verbs can function as the causing predicates of resultatives. As is clear from the examples cited by these scholars, “process or activity verbs” should be understood as verbs that involve an activity component, i.e. as including both activity and accomplishment predicates in terms of Vendler’s (1957) classification.

This paper argues that the claim that only a predicate involving an activity component can function as the causing predicate of a resultative cannot hold. It is organized as follows. Section 2 shows that there is evidence from Mandarin resultative verb compounds (RVCs) that the causing eventuality of a resultative can be a state. Section 3 discusses the theoretical and typological significance of a state eventuality’s functioning as the causing component of a resultative. The final section summarizes the main points made in the paper.

## 2. State Eventuality as the Causing Component

As shown in (1), it is true that the causing component of an English resultative can only be an activity or accomplishment verb, and cannot be a state or achievement verb.

- (1)
- a. John **ran** himself ragged. (activity)
  - b. John **ate** the plate empty. (accomplishment)
  - c. \*Bush **knew** John proud. (Intended: Bush knew John, and as a result John became proud.) (state)
  - d. \*John **found** his son happy. (Intended: John found his son, and as a result the son became happy.) (achievement)

However, crosslinguistically there is evidence from Mandarin RVCs that the causing predicate of a resultative is not necessarily an activity or

accomplishment predicate. As shown in (2), the causing eventuality of Mandarin RVCs can be a state, although as shown in (3), the causing component can also be an activity or accomplishment verb.

- (2) a. Zhangsan **lei**-bing-le. (state)  
 Zhangsan tired-sick-PERF  
 ‘As a result of Zhangsan’s being tired, he became sick.’  
 b. Zhangsan **e**-shou-le. (state)  
 Zhangsan hungry-thin-PERF  
 ‘As a result of Zhangsan’s being hungry, he became thin.’
- (3) a. Zhangsan **pao**-lei-le. (activity)  
 Zhangsan run-tired-PERF  
 ‘Zhangsan ran himself ragged.’  
 b. Zhangsan **chi**-kong-le panzi. (accomplishment)  
 Zhangsan eat-empty-PERF plate  
 ‘Zhangsan ate the plate empty.’

According to Vendler (1957: 146-147), states like *be tall* and achievements like *find* cannot be used in “continuous tenses” as shown in (4), and the two differ in that the former last for a period of time, while the latter occur instantaneously.

- (4) a. \*John is being tall.  
 b. \*John is finding the book.

Based on this, the stative status of *lei* in *lei-bing* ‘tired-sick’ and *e* in *e-shou* ‘hungry-thin’ in (2) can be established by the fact that as shown in (5), they cannot be used in the continuous tense (or, more exactly, in the progressive aspect) and that they have to be interpreted as lasting for a period of time when used in (2).<sup>2</sup>

- (5) a. \*Zhangsan zai lei.  
 Zhangsan PROG tired  
 Intended: ‘Zhangsan is in the continuous state of being tired.’  
 b. \*Zhangsan zai e.  
 Zhangsan PROG hungry  
 Intended: ‘Zhangsan is in the continuous state of being hungry.’

On the basis of the data from Mandarin RVCs, it can be concluded that the claim that only a predicate involving an activity component can function as the causing component of a resultative cannot hold crosslinguistically.

### 3. Theoretical and Typological Significance

The fact that a state eventuality can function as the causing component of a resultative is both theoretically and typologically significant. Theoretically speaking, the reason that many linguists make the claim that only a predicate involving an activity component can function as the causing predicate of a resultative is that resultatives are typically accomplishments,

which are generally assumed to involve an activity component. However, if it is agreed that Mandarin RVCs in (2) are accomplishments, then it can be concluded that accomplishments do not necessarily involve an activity component. Rather, they necessarily involve a duration component, which can be an activity or a state.

In addition to the theoretical significance, the fact that a state eventuality can function as the causing component of a resultative is also typologically significant. This is because crosslinguistically it is unusual for a stative predicate to serve as the causing component of a resultative. Specifically, by examining resultatives in eight languages (i.e. English, French, German, Japanese, Korean, Mandarin, Romanian, and Swedish), it is found that although the resultative in all the languages examined allows an eventuality which involves an activity component to function as the causing predicate, no grammatical counterparts of the two Mandarin examples in (2) are found in the other seven languages under investigation.

I argue that the rarity of the stative causing eventuality is partly because states are not typical causing eventualities, and partly because not many languages have the right resources to allow the using of a stative predicate as the causing component of a resultative. Specifically, if the resultative of a language is not realized as a compound, then its causing component must be an element which can function as the main predicate by itself. This predicts that adjectival stative predicates in English, French, German, Romanian and Swedish cannot serve as causing eventualities of resultatives, because, as shown in (6), an adjective like ‘tired’ in these languages cannot function as a predicate by itself when without a copula. As shown in (7), this prediction is borne out.

- (6) Intended: ‘John was tired’
- a. \*John tired.
  - b. \*John fatigué. (French)
  - c. \*John müde. (German)
  - d. \*John obosit. (Romanian)
  - e. \*John trött. (Swedish)
- (7) Intended: ‘As a result of John’s being tired, he became sick.’
- a. \*John tired sick.
  - b. \*John fatigué malade. (French)
  - c. \*John müde krank. (German)
  - d. \*John obosit bolnov. (Romanian)
  - e. \*John trött sjuk. (Swedish)

In addition, as shown in (8), although adjectives like ‘tired’ in Korean can be used as the main predicate of a sentence, ‘tired...sick’ as a resultative is bad in the language.

- (8) a. John-i phikonhay-ess-ta.  
John-NOM tired-PAST-IND  
‘John was tired.’

- b. \*John-i aphu-key phikonhay-ess-ta.  
 John-NOM sick-KEY tired-PAST-IND  
 Intended: ‘As a result of John’s being tired, he became sick.’

This is because such a resultative is strong in the sense that the causing component of the resultative does not implicate or entail a change denoted by the result component (cf. Washio 1997a, 1997b, 1999, 2002). However, there is independent evidence that Korean does not allow strong resultatives, as shown in (9).

- (9) a. \*Kutul-nun kwutwu-patak-lul yalp-key talli-ess-ta.  
 they-TOP shoe-soles-ACC thin run-PAST-DCL  
 ‘They ran the soles of their shoes thin.’ (Washio 1999: 682)  
 b. \*Mal-i thongnamwu-lul pantulpantulha-key kkul-ess-ta.  
 horse-NOM log-ACC smooth drag-PAST-DCL  
 ‘The horses dragged the logs smooth.’ (Washio 1999: 684)

Moreover, as shown in (10), although words like ‘tired’ can be used as predicates on their own in Japanese, ‘tired ... sick’ as a non-compound resultative is bad because as shown in (11-12), non-compound resultatives must be weak in this language in the sense that the causing predicate implicates or entails a change denoted by the result component (cf. Washio 1997a, 1997b, 1999, 2002). Therefore, as far as non-compound resultatives in Japanese are concerned, no predicates like ‘tired’ can be used as the causing eventuality, either.

- (10) a. Jon-wa tsukarete-ita.  
 John-TOP tired-exist.PAST  
 ‘John got tired.’  
 b. \*John-wa byooki-ni tsukarete-ita.  
 John-TOP sickness-NI tired-exist.PAST  
 Intended: ‘As a result of John’s being tired, he became sick.’

- (11) Strong Resultatives  
 a. \*Uma-ga maruta-o subesube-ni hikizut-ta.  
 horse-NOM log-ACC smooth drag-PAST  
 ‘The horses dragged the logs smooth.’ (Washio 1997b: 6)  
 b. \*Takusan-no hikooki-ga ozonsoo-o usuku ton-da.  
 many-GEN plane-NOM ozone.layer-ACC thin fly-PAST  
 ‘Many planes flew the ozone layer thin.’ (Washio 1997b: 20)

- (12) Weak Resultatives  
 a. John-ga kabe-o aoku nut-ta.  
 J.-NOM wall-ACC blue paint-PAST  
 ‘John painted the wall blue.’ (Washio 1997b: 2)  
 b. Boku-wa aisukuriimu-o katikati-ni koorase-ta.  
 I-TOP ice cream-ACC solid freeze-PAST  
 ‘I froze the ice cream solid.’ (Washio 1997b: 5)

It should be noted that so far we have been concerned with non-compound resultatives with an adjective as the causing eventuality. However, not all



stative predicates are in the form of an adjective, and there are stative predicates which are verbs, e.g. *be*, *resemble* and *know* in English. The question is whether such verbal statives can be used as the causing eventuality of a non-compound resultative.

An examination of possible resultatives formed with verbal stative predicates as causing eventualities in different languages shows that the answer to the above question is negative. To begin with, as shown in (13), such resultatives are ungrammatical in English.

- (13) a. \*John knows Bill proud. (Intended: John knows Bill, and as a result Bill becomes proud.)  
 b. \*John resembles Bill happy. (Intended: John resembles Bill, and as a result Bill becomes happy.)  
 c. \*John was a lawyer rich. (Intended: John was a lawyer, and as a result he became rich.)

Further, as shown in (14-15), non-compound resultatives like ‘know ... proud’ are ungrammatical in French, German, Japanese, Korean, Romanian, and Swedish as well.

- (14) Intended: ‘John knows Bill, and as a result Bill becomes proud.’  
 a. \*John connaît Bill fier. (French)  
     John knows Bill proud  
 b. \*John kennt Bill stolz. (German)  
     John knows Bill proud  
 c. \*John-wa Bill-o koei-ni shitte-iru. (Japanese)  
     John-TOP Bill-ACC proud-NI know-exist.PRES  
 d. \*John-i Bill-ul calangsulep-key an-ta. (Korean)  
     John-NOM Bill-ACC proud-KEY know.PRES-IND  
 e. \*John îl știe pe Bill mândru. (Romanian)  
     John him.ACC.CLITIC knows on Bill proud.  
 f. \*John känner Bill stolt. (Swedish)  
     John knows Bill proud
- (15) Intended: ‘John resembles Bill, and as a result Bill becomes happy.’  
 a. \*John ressemble à Bill heureux. (French)  
     John resembles to Bill happy  
 b. \*John ähnelt Bill glücklich. (German)  
     John resembles Bill happy  
 c. \*John-wa Bill-ni shiawase-ni nite-iru. (Japanese)  
     John-TOP Bill-DAT happy-NI resemble-exist.PRES  
 d. \*John-i Bill-ul hayngpokha-key talm-ta. (Korean)  
     John-NOM Bill-ACC happy-KEY resemble.PRES-IND  
 e. \*Ion seamănă cu Bill fericit. (Romanian)  
     John resembles with Bill happy  
 f. \*John liknar Bill glad. (Swedish)  
     John resembles Bill happy

As non-compound resultatives like ‘know ... proud’ are strong, their ungrammaticality in French, Japanese, Korean, and Romanian may be due

to the fact that these languages do not allow strong non-compound resultatives. However, the fact that such non-compound resultatives are also ungrammatical in English, German, and Swedish (all of which allow strong resultatives) suggests that the ungrammaticality of resultatives like ‘know ... proud’ might be due to semantic and pragmatic factors and to the fact that resultatives are complex predicates in a single clause. Specifically, unlike cases such as *John knows Bill, and as a result Bill becomes proud*, there seems to be more restrictions on the formation of monoclausal resultatives. As a result, monoclausal resultatives like *John knows Bill proud* that involve a great deal of practical reasoning to attain the resultative interpretation are generally banned, even in languages that allow strong resultatives.

The above explanation as to the ungrammaticality of resultatives that involve a causing predicate like *know* is further supported by the fact that such resultatives are bad even in the form of a compound. Take the compound resultative formed by ‘know’ and ‘proud’ as an example. As shown in (16), such a compound is bad not only in Japanese and Swedish but also in Mandarin (regardless of whether the reading is subject-oriented or object-oriented), although all these three languages allow RVCs.

- (16) Intended: ‘John knows Bill, and as a result John/Bill becomes (or has become) proud.’
- |    |          |                 |                   |            |
|----|----------|-----------------|-------------------|------------|
| a. | *John-ga | Bill-o          | shitteiri-hokoru. | (Japanese) |
|    | John-NOM | Bill-ACC        | know-be.proud     |            |
| b. | *John    | zhidao-zihao-le | Bill.             | (Mandarin) |
|    | John     | know-proud-PERF | Bill              |            |
| c. | *John    | stolt-känner    | Bill.             | (Swedish)  |
|    | John     | proud-know      | Bill              |            |

If compound resultatives involving a verbal causing predicate are not attested in any language investigated in this paper, a question arises as to whether compound resultatives that involve an adjectival causing predicate are allowed in Japanese and Swedish. The answer to this question is negative as well. First, concerning Japanese, compound resultatives that involve an adjectival causing predicate are not well-formed in this language because of a language-specific constraint, namely that Japanese resultative verb compounds must be composed of two verbal elements. For example, in (16a), *shitteiri-hokoru* is composed of two verbs, *shitteiru* ‘know’ and *hokoru* ‘be proud.’ In fact, even for those cases that involve a verbal causing predicate like *tsukareteiru* ‘be tired’ that is typically realized as an adjective in English and other languages, a well-formed compound resultative is apparently not attested because of the constraint mentioned above. Specifically, this is because the result component that is semantically compatible with such a causing predicate is either realized as a noun or as an adjective, thus violating the constraint that the two components of a Japanese RVC must be both verbal. For example, although (17) is grammatical in Mandarin, its counterpart is ungrammatical in Japanese as shown in (18) because the result component that corresponds to ‘sick’ is

realized as a noun, namely *byooki* and because there is no verb in the language that corresponds to ‘be sick’ or ‘get sick.’

(17) Zhangsan lei-bing-le.  
 Zhangsan tired-sick-PERF  
 ‘As a result of Zhangsan’s being tired, he became sick.’

(18) \*John tsukareteiri-byooki.  
 John be.tired-sickness  
 Intended: ‘As a result of John’s being tired, he became sick.’

As for Swedish, compound resultatives that involve an adjectival causing predicate are bad in the language for three reasons. First, note that the order of the two components of a Swedish RVC is “result component + causing component.” Second, Swedish RVCs are head-final. That is, the causing component is the head of a Swedish RVC and is the element that bears tense inflection. Finally, as shown earlier, Swedish adjectives cannot be tense bearers, and they have to resort to a copula to have tense inflection. Therefore, a Swedish RVC like *sjuk-trött* ‘sick-tired’ is ungrammatical, as shown in (19).

(19) \*John sjuk-trött.  
 John sick-tired  
 Intended: ‘As a result of John’s being tired, he became sick.’

It can be seen from the above discussion that the use of a state eventuality as the causing component of a resultative is crosslinguistically rare, and that the rarity is partly because states are not typical causing eventualities and partly because not many languages have the right resources to allow the using of a state predicate as the causing component of a resultative. Specifically, if the resultative of a language is not realized as a compound, then its causing component must be an element which can function as the main predicate by itself. This correctly predicts that English examples like *tired ... sick* and their counterparts in French, German, Romanian, and Swedish are bad because the causing predicate like ‘tired’ in these languages cannot function as a predicate by itself. Further, although similar predicates can be used on their own in Korean and Japanese, no resultatives formed with these predicates are attested. This is because on the one hand the resultatives formed with such causing predicates are strong, and on the other hand there is independent evidence that Korean resultatives and Japanese non-compound resultatives cannot be strong. Moreover, although there are stative predicates like ‘know’ which can be used without a copula, probably due to semantic (and) pragmatic reasons, no well-formed resultatives with such predicates as the causing component are attested. This is supported by the fact that even compound resultatives formed with stative predicates like ‘know’ are not attested in any language under investigation. As for compound resultatives that involve a causing predicate which is typically realized as an adjective in English and other languages, they are not attested in Japanese and Swedish, although these two languages have RVCs. Such compound resultatives are not found in Japanese because on

the one hand the two components of Japanese RVCs must be both verbs, and on the other hand either the stative causing component or the result component has to be expressed by a word which is not a verb. Similar compound resultatives are not attested in Swedish either, because the causing predicate is the head and needs to bear tense inflection and because in such cases, the causing predicates typically cannot be used without a copula and cannot be a tense bearer.

The crosslinguistic investigation undertaken in this section makes the following predictions. First, as far as non-compound resultatives involving a stative causing component are concerned, they are expected to be available only in languages where the causing component is an element that can function as the predicate of a sentence on its own and where the resultative formed with such a causing component does not involve too much practical reasoning (cf. the unavailability of such non-compound resultatives in English, French, German, Japanese, Korean, Romanian, and Swedish). Second, as for compound resultatives involving a stative causing component, they are likely to be found in languages like Mandarin where each of the two components of an RVC can function as a main predicate on its own so that regardless of which is the head of the RVC, the second component can be a tense or aspect bearer. Further, such compound resultatives are unlikely to be available in languages like Japanese where there is a constraint that both components have to be verbal and where either the stative causing component or the result component is typically realized as a category other than a verb. However, these compound resultatives are very likely to be found in languages where both components of an RVC are required to be verbal and where each component is typically realized as a verb.

Moreover, with respect to the causing predicate of resultatives, an implicational universal can be formulated. That is, if a language has resultatives which involve a stative causing predicate, then the language must allow resultatives which involve a causing predicate that is an activity or an accomplishment verb. The reason for this, I believe, lies in the fact that it is normal to have a result caused by an action, but unusual to have a result caused by a state.

Before we proceed to the final section, it should be pointed out that Kaufmann & Wunderlich (1998) regard the following sentences as involving a stative causing predicate.<sup>3</sup>

- (20) Kaufmann & Wunderlich (1998: 22-23; with glosses or translation added)
- a. Der Vorhang hängt sich glatt.  
the curtain hangs itself smooth  
'The curtain is hanging itself smooth.'
  - b. Der Säugling hat sich die Beine krumm gestanden.  
the baby has himself the legs bandy stood  
'The baby stood so that his legs became bandy.'
  - c. Er haßte sich in Raserei.  
he hated himself in rage  
'He hated himself into a rage.'

If so, then German, like Mandarin, also allows resultatives that involve a stative causing predicate. But the question is whether verbs like *hängen* ‘hang’ and *hassen* ‘hate’ (or *hassen* in the new orthography) express states. As there is no exact “continuous tense” or progressive aspect in German, the continuous tense test used by Vendler (1957) is inapplicable in this case. However, as far as the use of English *hang* and *hate* is concerned, the sentences in (21) show that they can be used in the progressive aspect.

- (21) a. The curtain is hanging there.  
 b. People are hating him for what he did.

Given this, *hang* and *hate* are not true state verbs by Vendler’s criterion. This at least provides some indirect evidence that *hängen* and *hassen* in (20) are not state predicates. In fact, as far as *hängen* in (20a) is concerned, it does not purely express a state; rather, it depicts a resulting state that is due to a hanging action. That is, the hanging action seems to be relevant to the meaning of *hängen* even in the case of (20a). This further suggests that *hängen* in this case is not a (pure) state predicate. In this regard, it needs to be pointed out that by Comrie’s (1976: 13) criterion that a state requires no “input of energy” (see also Nedjalkov & Jaxontov 1988: 4, Tenny & Pustejovsky 2000: 15), it seems that *hängen* ‘hang’ in (20a) is a state verb and *hassen* ‘hate’ in (20c) is not. However, by taking into consideration both Comrie’s criterion and Vendler’s continuous tense test, it can be concluded that neither *hängen* nor *hassen* is a state predicate. Based on this, I tend to view the main predicates in (20) as non-state verbs, and as a result I do not regard the three resultatives in (20) as involving a stative causing predicate.

#### 4. Summary and Conclusion

In sum, the paper shows that contra the usual claim that the causing predicate of a resultative must involve an activity component, there is evidence from Mandarin RVCs that a stative predicate can function as the causing component of a resultative as well. This finding is both theoretically and typologically significant. Theoretically, if it is agreed that Mandarin RVCs involving a stative causing predicate are accomplishments, then it can be concluded that accomplishments do not necessarily involve an activity component. Rather, they necessarily involve a duration component, which can be an activity or a state.

In addition to its theoretical significance, the fact that the causing predicate of a resultative can be a state is also typologically significant because crosslinguistically it is unusual for a stative predicate to serve as the causing component of a resultative. This rarity is partly because states are not typical causing eventualities, and partly because not many languages have the right resources to allow the using of a state predicate as the causing component of a resultative. Moreover, with respect to the causing predicate of resultatives, an implicational universal can be formulated. That is, if a language has resultatives which involve a stative causing predicate, then the language

must allow resultatives which involve a causing predicate that is an activity or an accomplishment verb.

## Notes

<sup>1</sup> I am grateful to my consultants for their time and patience: Jean-Charles Khalifa concerning French; Petra Burkhardt and Marianne Pouplier with respect to German; Kuniyoshi Ishikawa, Tatsuya Ito, Yutaka Kato, and Mariko Yanagawa with regards to Japanese; Seungja Choi, Hyoungbae Lee, Junkyu Lee, Hosung Nam and Minjung Son concerning Korean; Stefania Marin with respect to Romanian; Daniel Klamer, Rickard Melkersson and Peter Sundkvist regarding Swedish. I am also grateful to Masha Babyonyshev, Larry Horn, and Jim Huang for their constructive comments.

Abbreviations: ACC=accusative; DAT=dative; DCL=declarative; DEF=definite; FEM=feminine; GEN=genitive; IND=indicative; NEUT=neuter; NOM=nominative; PART=participle; PERF=perfective; PRES=present tense; PROG=progressive; SG=singular; TOP=topic marker.

<sup>2</sup> The progressive marker *zai* cannot be used with verbal statives either, as shown in (i).

- (i) \*Zhangsan zai zhidao Lisi.  
Zhangsan PROG know Lisi  
\*‘Zhangsan is knowing Lisi.’

<sup>3</sup> As shown below, similar English and Norwegian examples are found in the literature as well, although it should be pointed out that (20c) is “ungrammatical” or “rather odd” to my German consultants.

- (i) Tenny 1992: 17  
a. John resented his neighbor so much, he resented him right into the hospital (by attacking him with a bat).  
b. Mary admires her brother to pieces.
- (ii) Lødrup 2000: 176  
a. Kjøttet har hengt seg mørt  
meat-DEF have-PRES hang-PART REFLEXIVE tender-NEUT.SG  
‘The meat has hung itself tender.’  
b. Døra har stått seg skjev  
door-DEF have-PRES stand-PART REFLEXIVE lopsided-FEM.SG  
‘The door has stood itself lopsided.’

## References

- Comrie, Bernard. 1976. *Aspect*. Cambridge: Cambridge University Press.
- Giannakidou, Anastasia & Jason Merchant. 1999. “Why Giannis can’t scrub the plate clean: On the absence of resultative secondary predication in Greek”, *Greek Linguistics '97, Proceedings of the 3<sup>rd</sup> International Conference on Greek Linguistics*, 93-103.
- Kaufmann, Ingrid & Dieter Wunderlich. 1998. “Cross-linguistic patterns of resultatives”, *Theorie des Lexikons, Arbeiten des Sonderforschungsbereichs 282*. No. 109.
- Li, Jen-i Jelina. 1994. “Information compatibility and resultative verb compounds in Mandarin”, *BLS 20* (General Session): 351-361.
- Lødrup, Helge. 2000. “Underspecification in Lexical Mapping Theory: The case of Norwegian existentials and resultatives”, *Argument Realization*, ed. by Mariam Butt & Tracy Holloway King, 171-188. Stanford: CSLI Publications.
- Nakamura, Masaru. 1997. “On resultative constructions”, *Studies in English Linguistics: A Festschrift for Akira Ota on the Occasion of His Eightieth Birthday*, ed. by Masatomo Ukaji et al., 492-511. Tokyo: Taisyukan.

- Nedjalkov, Vladimir P. & Sergej Je. Jaxontov. 1988. "The typology of resultative constructions", *Typology of Resultative Constructions*, ed. by Vladimir P. Nedjalkov (and the English translation edited by Bernard Comrie), 3-61. Amsterdam/Philadelphia: John Benjamins.
- Pustejovsky, James. 1991. "The syntax of event structure", *Cognition* **41**: 47-81.
- Rapoport, Tova R. 1990. "Secondary predication and the lexical representation of verbs", *Machine Translation* **5**: 31-55.
- Rothstein, Susan. 2004. *Structuring Events: A Study in the Semantics of Lexical Aspect*. Oxford: Blackwell.
- Tai, James H-Y. 1984. "Verbs and times in Chinese: Vendler's four categories", *Papers from the Parasession on Lexical Semantics*, ed. by David Testen, Veena Mishra & Joseph Drogo, 289-296. Chicago: Chicago Linguistic Society.
- Tenny, Carol. 1992. "The Aspectual Interface Hypothesis", *Lexical Matters*, ed. by Ivan A. Sag & Anna Szabolcsi, 1-27. Stanford: CSLI Publications.
- Tenny, Carol & James Pustejovsky. 2000. "A history of events in linguistic theory", *Events as Grammatical Objects*, ed. by Carol Tenny & James Pustejovsky, 1-37. Stanford: CSLI Publications.
- Vendler, Zeno. 1957. "Verbs and times", *The Philosophical Review* **66**: 143-160.
- Washio, Ryuichi. 1997a. "Remarks on Korean resultatives", *Researching and Verifying an Advanced Theory of Human Language: COE Research Report 1*, 221-254. Kanda University of International Studies.
- Washio, Ryuichi. 1997b. "Resultatives, compositionality and language variation", *Journal of East Asian Linguistics* **6**: 1-49.
- Washio, Ryuichi. 1999. "Some comparative notes on resultatives", *Linguistics: In Search of the Human Mind*, ed. by Masatake Muraki and Enoch Iwamoto, 674-707. Tokyo: Kaitakusha.
- Washio, Ryuichi. 2002. "Some typological implications of Mongolian resultatives", *English Linguistics* **19**: 366-391.
- Wechsler, Stephen. 1997. "Resultative predicates and control", *Texas Linguistic Forum* **38**: 307-321.

Chao Li  
 370 Temple Street  
 Linguistics Department  
 Yale University  
 New Haven, CT 06520  
 chao.li@yale.edu

# Local and Non-local Blocking in Vowel Harmony

**Shakuntala Mahanta**

Utrecht Institute of Linguistics-OTS

## 1 Introduction

Canonical vowel harmony is expected to spread from vowel to vowel without affecting or being affected by intervening consonants. However that is only an ideal state of affairs and it is often violated<sup>1</sup>. In this paper, I take the position that harmony involves the establishment of local relationships, but this relationship is violated if a potential undergoer of the relationship intervenes and blocks the process. This paper will be mainly informed by the facts of Assamese, therefore I will first present the basic harmony facts of Assamese.

### 1.1 Assamese vowel harmony

There are eight surface vowels in Assamese, where /i/ and /u/ trigger harmony to /ɛ/ /ɔ/ and /ʊ/.

|     |                            |        |  |
|-----|----------------------------|--------|--|
| (1) | Vowel phonemes of Assamese |        |  |
| i   | u                          | [+ATR] |  |
|     | ʊ                          | [-ATR] |  |
| e   | o                          | [+ATR] |  |
| ɛ   | ɔ                          | [-ATR] |  |
|     | a                          | [-ATR] |  |

All vowels in a word must agree in the feature value [ATR]. Examples of vowel harmony are presented below. In (2), the first person suffix /-i/ triggers a change in the mid vowel:

|     |                        |            |                    |                               |
|-----|------------------------|------------|--------------------|-------------------------------|
| (2) | Assamese vowel harmony |            |                    |                               |
|     | verbal stem            | inflection | inflected form     | Gloss                         |
| a   | lek <sup>h</sup>       | -i         | lek <sup>h</sup> i | write, 1 <sup>st</sup> Pres   |
| b   | sep                    | -i         | sepi               | squeeze, 1 <sup>st</sup> Pres |



Vowel harmony is not only caused by an inflectional suffix, but also by derivational endings, as the following examples illustrate. In the examples below, /-i/ and /-uwa/ suffixes trigger harmony.

(3) /uwa/ harmony triggers

| Root                  | Gloss | Suffix | Derivation           | Gloss(Derivation)        |
|-----------------------|-------|--------|----------------------|--------------------------|
| a. pə̀lə̀x            | silt  | -uwa   | poloxuwa             | fertile land             |
| b. mə̀r               | curl  | -uwa   | meruwa               | curled                   |
| c. gùbər             | dung  | -uwa   | guboruwa             | fly with dung-like smell |
| d. b <sup>h</sup> ùl | daze  | -uwa   | b <sup>h</sup> uluwa | mislead                  |

(4) /i/ suffix

| Root                    | Gloss | Suffix | Derivation           | Gloss(Derivation) |
|-------------------------|-------|--------|----------------------|-------------------|
| a. b <sup>h</sup> əkula | frog  | -i     | b <sup>h</sup> ekuli | frog (dim)        |
| b. ùpər                | above | -i     | upori                | in addition       |
| c. k <sup>h</sup> ərəs  | spend | -i     | k <sup>h</sup> orosi | prodigal          |
| d. nərək                | hell  | -i     | noroki               | sinful            |
| e. bəsər                | year  | -i     | bosori               | yearly            |

The core of this paper deals with three kinds of blocking encountered in Assamese: (i) Blocking by /a/ (ii) Blocking by nasals (iii) Blocking by consonant clusters. The goal of this paper is to show that local intervention by both vowels and consonants are driven by the same principle – intervention by segments which can potentially bear the relationship of harmony. But non-local blocking, i.e. intervention by segments which are not segmentally adjacent is the result of prosodic requirements only.

## 2 Blocking by /a/

In vowel harmony languages, under circumstances where a non-alternating vowel occurs between the target vowel and the trigger, the harmony span of the triggering vowel is blocked. Hence these non-alternating vowels are called opaque vowels. A very common vowel is /a/.

(5) Assamese trisyllables with medial /a/ and final /i/

|            |                       |
|------------|-----------------------|
| a. mə̀dahi | ‘drunkard’            |
| b. kə̀pahi | ‘of cotton’           |
| c. pətari  | ‘covered cane basket’ |
| d. zukari  | ‘shake’               |

The examples in (5) above are words in which /a/ occurs word-medially and there is no agreement with the [+ATR] value of the triggering vowel /i/ on the right hand side. I put forward the view that low vowels are resistant to

change because of their high sonority. Intrinsic sonority of vowels are widely accepted to follow the following hierarchy:

- (6) Relative sonority of vowels:  
 LOW > MID > HIGH  
 a > e, o, > i, u

My theoretical position in this paper is that /a/'s sonority is linked to its inertness. In other words the 'faithfulness' of the most sonorous vowel in the hierarchy is directly linked to its phonological opacity<sup>2</sup>.

### 3 Consonantal Intervention in Assamese Vowel Harmony

The thrust of this paper is also to show that vowel harmony blocking by consonants should not to be considered an anomaly and consequently, one of the goals of this paper is to explore the phonological reasons for these occurrences. I do not address the issue of feature spreading to all elements (in a certain domain) *per se*. Rather I show that in Assamese non-vocalic elements may *block* harmony. In other words, even though consonantal elements may allow harmony to permeate from one element to the other, there may be consonantal segments which stop harmony from spreading. Vowel harmony blocking by consonants is driven by the principle of 'similarity' in the appropriate local domain<sup>3</sup>. The problem lies in defining in what exactly similarity is. I propose that a consonant's similarity to a vowel in vowel harmony can be evaluated in two ways: i) it can be measured by a consonant's proximity to vowels in a sonority scale. ii) Similarity can also be apparent from features that both vowels and consonants share.

#### 3.1 Nasals blocking harmony in Assamese

Vowel harmony is sometimes blocked by intervening nasal consonants. In (7 a-f) vowel harmony is blocked by an intervening nasal consonant.

(7) Vowel harmony blocked by intervening nasal segments

- |                          |                   |                           |
|--------------------------|-------------------|---------------------------|
| a. sekɔni                | 'strainer'        | (*sekoni)                 |
| b. xɔmɔnia               | 'colleague'       | (*xomonia)                |
| c. pɔtɔni                | 'dumping ground'  | (*putoni)                 |
| d. k <sup>h</sup> ɔmir   | 'leavening agent' | (*k <sup>h</sup> omir)    |
| e. xɔmik <sup>h</sup> ɔn | 'survey'          | (*xomikk <sup>h</sup> on) |
| f. zɔŋi                  | 'piquant'         | (*zoŋi)                   |

All the nasals /n/, /m/ and /ŋ/ block harmony in the examples above. A nasal immediately preceding the potentially triggering vowel always blocks harmony (i.e. if the nasal is in the onset position of a syllable containing /i/

or /u/, vowel harmony will not take place; whereas a nasal somewhere else in the word does not function as a blocker. The special feature of Assamese is that there is also a positional restriction on the nasals which block harmony. In (8) (a)-(c) the words end in a syllable with a high vowel and all vowels agree in [+ATR] despite the presence of a nasal within the word:

(8) No blocking when the nasal is not adjacent to the triggering vowel

- a. porinoti           ‘consequence’
- b. ponoru           ‘onion’
- c. somokit           ‘frightened suddenly’

Thus only when a sequence of the mid vowel is followed by a nasal, harmony is blocked. Nasals blocking harmony is a local process, i.e., the spreading process can be arrested by an intervening nasal only when it immediately precedes the triggering element. I assume that in the case of consonantal blocking in vowel harmony, the following (ad-hoc) principle plays a role:

- (9) Let  $a > b > c$  be a string of segments in the input, for any agreement relation  $\mathfrak{R}$  in terms of feature (f), such that the potential output is  $a(+f) > b(+f) > c(+f)$ , but the actual output is  $a(+f) > b(-f) > c(-f)$ , if  $b$  prevents agreement, then  $b$  is vocally compatible/ has agreeable features and  $b$  is segmentally adjacent.

The criteria of locality which is to be executed with the principle stated above must incorporate the following:

- (10) Let  $a$  and  $b$  be segments in the output, such that:

- a.  $a$  linearly precedes  $b$  in the output
- b. And there is no element  $c$  which intervenes between  $a$  and  $b$ .

The feature [+ATR] percolates leftward from one non-low vowel to the next until it reaches the beginning of the word or a low vowel and this process of regressive harmony can be arrested by an intervening nasal existing in an immediately preceding position to the triggering vowel.

### 3.2 Nasalization and harmony: acoustic and articulatory factors

Though cross-linguistically not abundantly attested, nasals blocking/participating in harmony cannot be considered an aberration. Existing linguistic theories had already presupposed that vowels and nasals interact more easily than other [ $\pm$ continuant] features. (for instance, nasal harmony, see Walker 1999 for an implicational hierarchy). Trigo (1987, 1991) shows that in Madurese, while the presence of voiced obstruents leads to [+ATR] vowels, the presence of nasals and voiceless obstruents results in [-ATR] vowels. Trigo notes that this: (a) enhances the perception of nasality as their resonances are close together; (b) nasality and low

vowels are articulatorily related - one of the muscles that constricts the pharynx also lowers the soft palate. Trigo expresses this in the form of the representation below:

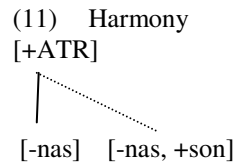

In Ijesa and Ekiti, (Przedziecki, 2005), pronouns with nasal vowels do not alternate.

- (12) [+ATR] [-ATR]
- a. órígì ‘s/he saw a tree.’ órílá ‘s/he saw okra.’
- b. ěrígì ‘you (pl) saw a tree.’ ěrílá ‘you (pl) saw okra.’

In Karaja (Ribeiro 2002), the vowels /ã/, /õ/, and /ẽ/ are opaque, systematically blocking harmonization:

- (13) Blocking by nasal vowels in Karaja
- a. rɛhãɖere ‘I hit (it).’
- b. rakõhõdekõre ‘He/she didn’t hit.’
- c. rɛmẽre ‘I caught (it).’

Whalen and Beddor (1988) show that in Eastern Algonquian, nasalisation developed without any consonantal conditioning. Whalen and Beddor show that a correlation between low vowels and distinctive nasalisation is not uncommon cross-linguistically. This is probably connected to the lower position of the velum found for low vowels. Beddor (1983:168) comments that many languages in her study “involve tongue position differences between oral and nasal vowels”. Her study showed that high nasal vowels show a greater tendency to be lower than oral vowels. While Madurese shows a direct connection between [-ATR] and nasal consonants, the other examples above show a correlation between nasal vowels and height, i.e. there are constraints in the co-occurrence of the two. While this does not directly translate into a featural configuration of nasal as [-ATR], it can be deduced that there are articulatory constraints in nasals and non-low vowels occurring together. Further, postulating a [-ATR] feature for nasals does not help us in Assamese, because only when the back [-ATR] is in the onset position of the syllable containing the triggering vowel, does it fail to harmonise in the presence of nasals. Nasals in all other positions do not inhibit harmonic agreement.

#### 4 Other Approaches to Harmony Blocking by Consonants and Vowels

Till now I have shown that vowel harmony blocking by both vowels and consonants is the result of an intervention of a compatible segment in the appropriate local domain. This is also evident from other phenomena where consonant-vowel interactions involve agreement, as features like dorsal, coronal and labial can be seen as properties of both vowels and consonants. However, discussing consonantal interference in vowel harmony van der Hulst and van de Weijer(1995:530) state that:

“Cases where such interaction takes place have been used to argue that features for representing place in consonants and vowels are partly the same, but precisely under what circumstances vowels harmonize with consonants is not clear...”

van der Hulst and van de Weijer (1995) consider consonants influencing vowel harmony to be drawbacks to a theory of harmony where only syllable heads are expected to participate in harmony. Further, the impetus for consonant - vowel interactions have always been thought to be subject to some intervening secondary articulatory phenomenon. In vowel harmony languages, the interaction between vowels and consonants was noticed primarily in Turkish, where secondary place features trigger harmony, imitating rounding vowel harmony in Turkish. Clements and Sezer (1982) report Turkish words where palatalized /k<sup>j</sup>/ spread their palatalized quality to following suffix vowels.

(14) /k<sup>j</sup>/ determines vowel harmony in Turkish

- |                          |                                      |               |
|--------------------------|--------------------------------------|---------------|
| a. infil <sup>ʃ</sup> ak | infil <sup>ʃ</sup> ak <sup>j</sup> i | explosion     |
| b. idrak                 | idrak <sup>j</sup> i                 | perception    |
| c. ittifak               | ittifak <sup>j</sup> i               | alliance      |
| d. istirak               | istirak <sup>j</sup> i               | participation |
| e. helak                 | hel <sup>ʃ</sup> ak <sup>j</sup> i   | exhaustion    |

There are also other palatal harmony languages like Bashkir, where front velars are found in words with [-back] vowels and back velars are found in words with [+back] vowels. (Poppe 1962, van der Hulst and van de Weijer 1995). But examples of non-(syllable) nuclear interception in harmony is not unheard of. The oft-cited example is that of Warlpiri, where labial consonants require following vowels to be round (Nash 1979, van der Hulst and Smith 1985).

(15) Labial harmony in Warlpiri

- |                   |                       |
|-------------------|-----------------------|
| a. ŋamirni-puraji | ‘uncle your’          |
| b. ŋali-wurru     | ‘we two (incl.)-EMPH’ |

And also in Turkish, where the palatal lateral blocks harmony if it is in the final position:

(16) Palatal laterals block harmony in Turkish

|    |           |            |        |
|----|-----------|------------|--------|
|    | /petroλ/  | ‘gasoline’ |        |
| a. | petroλ    | *petrol    | nom sg |
| b. | petroλ-y  | *petroλ-u  | acc sg |
| c. | petroλ-de | *petroλ-da | loc-sg |

The palatal laterals interaction with harmony shows that harmony is not a syllable head to syllable head interaction. Levi (2004) shows that harmony blocking of this kind is about the interaction of appropriate features.

#### 4.1 Feature theories

Various theories of feature geometry have been proposed to capture the intricacies of feature spreading in languages. In Articulator Theories, consonant-vowel interactions are accounted for by rules which can be indexed for marked, contrastive or all feature specifications. In the Revised Articulator Theory (Halle, Vaux, Wolfe 2000) feature spreading is seen as an operation affecting only the terminal nodes of the feature tree. Contrastiveness (in the sense of Calabrese 1995), and markedness rules which plays a significant role here. Some feature combinations are marked, and in languages where the marked combination exists, the two values of the feature are contrastive. According to the Revised Articulator Theory, only contrastive features are *visible* to the harmony rule.

However, if a segment is non-contrastive for a particular feature then spreading does not affect it. The following example is from Nawuri. Nawuri contrasts plain and rounded labial consonants in its phonemic inventory: /p/ contrasts with /p<sup>w</sup>/ and /b/ with /b<sup>w</sup>/, /f/ with /f<sup>w</sup>/ and /m/ with /m<sup>w</sup>/ (Casali 1995). In the Revised Articulator Theory rounded labials are contrastively specified as [+round] and plain labials are contrastively specified as [-round]. This rule is applicable only to contrastive [round] specifications, it is blocked by the contrastive [-round] plain labials, but in other cases where segments without the relevant contrast intervene the rule applies successfully. Thus the singular noun-class prefix /gI/ becomes round before a round vowel in a following syllable.

(17) Nawuri spreading

| Underlying form | surface form | Gloss   |
|-----------------|--------------|---------|
| a. gI-su        | gusu         | ‘ear’   |
| b. gI-lɔ        | gulɔ         | illness |

But the rule of rounding is blocked by contrastive segments:

|         |      |        |
|---------|------|--------|
| c. gImu | gimu | ‘heat’ |
|---------|------|--------|

d. gI-fufuli      gifufuli      ‘white’

There is no way to show that nasals are contrastive for the feature [ATR] in Assamese. On the other hand, non-contrastiveness implies that nasals are transparent to the harmony process, which is not the case. In principle, Articulator Theories predict consonant-vowel interactions, but this is mediated by some conventions. When the conventions fail to apply, then there is no way of deriving consonant-vowel interaction in a principled way.

### 5 Harmony Blocking by Coda Consonants

In the literature on harmonic processes, it has been commonly shown that harmony is a process of establishing a relation of identity between adjacent syllables, moras etc. (Archangeli and Pulleyblank 1994, van de Weijer and van der Hulst 1995, Krämer 2001, Piggott 1999).

Now let us turn to the instances of disharmony when there are more than one consonant intervening between the triggering vowel and the target vowel<sup>4</sup>. The existence of multiple consonants create an impediment in spreading of the harmonizing feature values. The observed facts are completely phonological.

(18) disharmony in the presence of two intervening consonants

- |                         |                              |
|-------------------------|------------------------------|
| a. kəl.ki               | ‘last incarnation of Vishnu’ |
| b. xɔ.rɔs. wo.ti        | ‘Hindu goddess of learning’  |
| c. gəs.t <sup>h</sup> i | ‘clan’                       |
| d. ket.li               | ‘kettle’                     |
| e. kər.ke.tuwa          | ‘squirrel’                   |

Similarly, in derivations too, whenever there are two intervening consonants, vowel harmony is blocked. This is shown below:

(19) Derived words where harmony is absent due to two intervening consonants

| Root                   | Gloss      | Suffix | Derivation           | Gloss(Derivation)       |
|------------------------|------------|--------|----------------------|-------------------------|
| a. səkɾɔ               | ‘circle’   | ika    | səkrika              | ‘platelet’              |
| b. kəlɔ                | ‘wish’     | i      | kəlpi                | ‘one who imagines’(fem) |
| c. k <sup>h</sup> ɔndɔ | ‘fragment’ | it     | k <sup>h</sup> ɔndit | ‘severed’               |
| d. xɔb.dɔ              | ‘sound’    | it     | xɔb.dit              | ‘resounded’             |

I propose that harmony blocking in closed syllables is a result of the moraic nature of syllable final consonants in Assamese. Assamese follows a Trochaic (strong-weak) rhythm at the left edge of the word, and therefore invariably stresses the initial syllable. However, owing to quantity

sensitivity, if a heavy syllable immediately follows a light syllable, the heavier counterpart emerges as the stress-bearing unit. The examples in (21) and (22) show that Assamese stresses the initial syllable. However, owing to quantity – sensitivity, if a heavy syllable immediately follows a light syllable, the heavier counterpart emerges as the prominence bearing unit. The second syllable is prominent if it is heavy and the first syllable is light. Otherwise the first syllable is prominent. Assamese follows a trochaic rhythm and therefore stresses the initial syllable.

## (20) Disyllables

| (LL)        | Gloss    | (H)H                      | Gloss     |
|-------------|----------|---------------------------|-----------|
| a. [só.ku]  | ‘eye’    | c. [bón.dər]              | ‘port’    |
| b. [ráti]   | ‘night’  | d. [án.d <sup>h</sup> ar] | ‘dark’    |
| <b>L(H)</b> |          | <b>(H)L</b>               |           |
| e. [zí.bən] | ‘life’   | g. [gór.bə]               | ‘pride’   |
| f. [ba.gán] | ‘garden’ | h. [zón.trə]              | ‘machine’ |

## (21) Trisyllables

| (LL)L          |              | (LL)(H)         |            |
|----------------|--------------|-----------------|------------|
| a. [gó.hə.na]  | ‘jewellery’  | c. [mó.rə.mər]  | ‘loved’    |
| b. [zó.hə.ni]  | ‘cholera’    | d. [zá.za.bər]  | ‘vagabond’ |
| <b>L(H)L</b>   |              | <b>L(H)H</b>    |            |
| e. [a.nón.də]  | ‘happiness’  | g. [a.róm.bər]  | ‘luxury’   |
| f. [gu.rút.tə] | ‘importance’ | h. [ə.hón̩.kar] | ‘pride’    |

This shows that coda consonants are moraic in the language and therefore all VC / CVC / CVCC syllables are labelled heavy (H). This factor (Weight by position) renders all closed syllables potential stress bearing units.

### 5.1 Conclusion

The imperative then, is that there are some conditions on the systematic intervention by consonants in a vowel harmony domain. I summarise them as below:

If an adjacent consonant triggers or blocks harmony that consonant has to be vocally compatible. The notion of compatibility as used here should be understood as those elements which have a higher sonority, and therefore cross-linguistically show properties which are universally attributed to vowels. Nasals in Assamese can block harmony and primary as well as



secondary palatal features in Turkish can block harmony because they are compatible with vocalic segments.

Non-compatible interveners may not be segmentally adjacent, but they will be constrained by prosodic factors.

Nasals in Assamese can block harmony and palatal laterals in Turkish can trigger harmony because they are compatible with vocalic segments. In this way, I offer a maximally simple characterization of harmony obstruction by consonantal segments. In vowel harmony, therefore, primary place features of consonants do come into play. It is not important whether the primary or secondary features interact with harmony, or not, what is relevant is whether the segment which is involved in the harmonic domain is vocally compatible or if the consonantal segment shares some vocalic feature.

## Notes

---

<sup>1</sup> Under the strict locality condition (Ni Chiosain and Padgett 1997, 2004, Walker 1998), it is expected that vowel harmony will influence all the intervening segments, without resulting in distinctive featural changes.

<sup>2</sup> While discussing the inapplicability of non-contrastive visibility to various case of opacity, Nevins (2004) proposes that instead of non-contrastiveness, sonority should be considered the guiding principle in assessing opaque interactions in languages. This argument is fuelled by data from Wolof, Hungarian, and written Manchu etc., where despite the presence of contrastive vowels, only the non-contrastive ones are opaque.

<sup>3</sup> Nino Grillo (p.c.) points out that such a notion of locality has also been exemplified in syntax, where, under Relativized Minimality (Rizzi 1990 1997) approach, a local structural relation between X and Y is disrupted by Z, iff (i) Z is potential bearer of the relation (ii) Z intervenes between X and Y.

<sup>4</sup> The absence of [+ATR –hi] vowels in closed syllables may lead us to suspect that this is a Morpheme Structure Constraint. However, such a line of thinking do not help us when vowel harmony *do* appear in closed syllables. For instance there are words in the lexicon like /bostu/ /bond<sup>h</sup>u/ etc. In Assamese vowel harmony, there are also cases where an /i/ deletes under hiatal conditions, and the result of the process shows harmony within a closed syllable – for instance /ɾɔ/ ‘wait’ + /il/ ‘past’- /ɾol/ etc.

## References

- Archangeli Diana and Douglas Pulleyblank. 1994. *Grounded Phonology*. Cambridge Massachusetts: MIT Press.
- Calabrese, Andrea. 1995. ‘A constraint-based theory of phonological markedness and simplification procedures’, *Linguistic Inquiry*, **26.3**: 373–463.
- Clements, Nick. 1976. *Vowel Harmony in Nonlinear Generative Phonology: An Autosegmental Model*. [Distributed by Indiana University Linguistics Club, Bloomington (1980).]
- Clements, Nick. 1985. ‘The geometry of phonological features’. *Phonology Yearbook*, **2**: 225–252.

- 
- Clements, Nick. 1987. 'Toward a substantive theory of feature specification'. In *Proceedings of NELS 18*: 79–93. GLSA, University of Massachusetts, Amherst.
- Clements, Nick. 1989. A unified set of features for consonants and vowels. Ms., Cornell University, Ithaca, N.Y.
- Clements, Nick, and Elizabeth Hume. 1995. The internal organization of speech sounds. In *Handbook of Phonological Theory*, ed. John Goldsmith, 245–306. Oxford: Blackwell.
- Clements, Nick and Engin Sezer. 1982. 'Vowel and consonant disharmony in Turkish'. In *The structure of phonological representations, part II*, eds. Harry van der Hulst and Norval Smith, 213–255. Dordrecht: Foris.
- Frisch, Stefan. 1996. *Similarity and Frequency in Phonology*. PhD dissertation, Northwestern University.
- Frisch, Stefan, Janet Pierrehumbert & Michael Broe. In press. 'Similarity avoidance and the OCP'. *NLLT*.
- Gafos, Diamandis. 1996. The Articulatory Basis of Locality in Phonology. PhD dissertation, Johns Hopkins University. [Published by Garland, New York, 1999.]
- Goldsmith, John. 1979. *Autosegmental Phonology*. New York: Garland Publishing.
- Halle, Morris. 1995. 'Feature geometry and feature spreading'. *Linguistic Inquiry* 26. 1: 1-46.
- Halle, Morris, Bert Vaux, and Andrew Wolfe. 2000. 'On feature spreading and the representation of Place of Articulation'. *Linguistic Inquiry* 31.3: 387-444.
- Hayes, Bruce. 1989. 'Compensatory lengthening in moraic phonology'. *Linguistic Inquiry* 20. 2: 253-306.
- Hayes, Bruce. 1995. *Metrical Stress Theory: Principles and Case Studies*. Chicago: The University of Chicago Press.
- Hulst, Harry van der and Jeroen van de Weijer. 1995. Vowel Harmony. In *The Handbook of Phonological Theory*. John A. Goldsmith, ed. 495-534. Oxford: Blackwell.
- Hulst, Harry van der and Norval Smith. 1985. Vowel features and Umlaut in Djingili, Nyangumarda and Warlpiri. *Phonology* 2: 277-303.
- Hyman, Larry. 1985. *A Theory of Phonological Weight*. Dordrecht, Holland: Foris Publications.
- Krämer, Martin. 2001a. 'Yucatec Maya vowel alternations – Harmony as Syntagmatic Identity'. *Zeitschrift für Sprachwissenschaft* 20. 175-217.
- Levi, Susannah V. 2001. 'Glides, laterals, and Turkish vowel harmony'. *CLS* 37: 379-394.
- Nash, David. 1979a. 'Warlpiri vowel assimilations'. *MIT Working Papers in Linguistics* 1: 12-24.
- Nevins, Andrew (2004) Conditions on (Dis)harmony, PhD Dissertation, MIT.
- Ni Chiosain, Maire, and Jaye Padgett. 1997. 'Markedness, segment realisation, and locality in spreading'. Report LRC-97-01, Linguistics Research Center, University of California, Santa Cruz.
- Odden, David. 1991. 'Vowel geometry'. *Phonology* 8:261–290.
- Mahanta, Shakuntala (2002). Some Aspects of Prominence in Assamese. M.Phil Dissertation. CIEFL, Hyderabad. ROA:715
- Padgett, Jaye. 1995. 'Feature classes'. In *University of Massachusetts occasional papers 18: Papers in Optimality Theory*, 385–420. GLSA, University of Massachusetts, Amherst.
- Piggott, Glynne. 1999. Implications of consonant nasalization for a theory of harmony. *Canadian Journal of Linguistics*. 41: 141 – 174.
- Poppe, N. 1962. *Bashkir Manual*. Uralic and Altaic series, vol. 36. Bloomington: Indiana University.

- 
- Przezdziecki, Marek. 2005. Vowel Harmony and Co-articulation in Three Dialects of Yoruba. Ph.D Dissertation. Cornell University.
- Ribeiro, Eduardo Rivail. 2001. '[ATR] vowel harmony and palatalization in Karajá'. Ms. University of Chicago.
- Sharon Rose and Rachel Walker. 2004. 'A typology of Consonant Agreement as Correspondence. *Language*' **80**. 3 : 475 – 531.
- Sagey, Elizabeth. 1986. The Representation of Features and Relations in nonlinear phonology. Doctoral dissertation, MIT, Cambridge, Mass.
- Steriade, Donca. 1987. 'Locality conditions and feature geometry'. In *Proceedings of NELS 17*, 339–362. GLSA, University of Massachusetts, Amherst.
- Steriade, Donca. 1995. Underspecification and markedness. In *The Handbook of Phonological theory*, ed. John Goldsmith, 114–174. Oxford: Blackwell.
- Trigo, Loren. 1991. 'On pharynx-larynx interactions'. *Phonology* **8**:113–136.
- Vaux, Bert. 1996. 'The status of ATR in feature geometry'. *Linguistic Inquiry* **27**:175–182.
- Vaux, Bert. 1999a. 'A note on pharyngeal features'. In *Harvard working papers in linguistics* **7**, 39–63. Department of Linguistics, Harvard University, Cambridge, Mass. [An earlier version from 1993 entitled "'ATR-Voice Interactions and the Geometry of the Lower Vocal Tract'" was circulated in manuscript form.]
- Walker, Rachel Leah. 1998. Nasalization, Neutral Segments, and Opacity effects. PhD dissertation, University of California Santa Cruz.
- Whalen, D.H. and Beddor, P.S., 1988. 'Connections between nasality and vowel duration and height: elucidation of the Eastern Algonquian intrusive nasal', *Language and Speech*, 31, 57-75

*Shakuntala Mahanta, UiL-OTS, Utrecht University,  
Janskerkhoff 13, 3512 BL, Utrecht.*



If there is no expletive, and the object in (1) is in spec TP as shown in (5) (Bailyn 2003; Lavine and Freidin 2002), then it should be able to bind a subject-oriented anaphor and show co-reference under conjunction elision. However, this is not possible, as shown in (6a,b).

(5) [TP Boat-acc(i) T ... [VP t(i) V carried-away...]]

(6) a. \*Dimu(i) ubilo svojej(i) puljej  
 Dima-acc killed-3rdSgNeut self's bullet  
 Dima got killed by his own bullet

b. \*Dim-u(i) ubilo i (i)\_ upal  
 Dima-acc killed and fell  
 Dima got killed and fell down

So, the Adversity Impersonal construction (1) is a problem: it involves a seemingly unmotivated movement of the object that has neither A- nor A'-properties. We ask: (a) why is the object fronted in (1)? (b) where does it wind up? The answer to (a) and (b) should also explain the cause for object movement and its position in the OVS construction given in (7) (Bailyn 2003) that involves an overt subject:

(7) Dimu udaril Misha  
 Dima-acc hit-3rdSgMsc Misha-Nom  
 MISHA hit Dima (obligatory focus on 'Misha')

(7) poses an additional problem: there is a Minimality-violating movement of the object over the overt subject.

## 1.2 Previous proposals

### 1.2.1 Levine and Freidin (2002)

Levine and Freidin (2002) argue that the Adversity Impersonal construction involves a movement of the accusative object into spec TP (A-movement). There is default agreement on the T because the T lacks a complete set of phi-features. The fronted object checks the EPP on the T, while the phi-complete v checks accusative case on the object.

However, the claim that the fronted object is in spec TP is challenged by the fact that it is unable to bind a subject-oriented anaphor (cf6a). Furthermore, the proposal that in the Adversity Impersonal construction the T lacks a full set of phi-features, while the v has one, misses an important generalization: namely, Adversity Impersonal constructions are never agentive (see Section 3 below). The authors, on the other hand, predict that *anytime* we have a phi-defective T,

we should expect an Adversity Impersonal construction regardless of the agentivity of the verb.

### 1.2.2 Baily (2002, 2003)

As Levine and Freidin (2001), Baily (2001, 2003) argues that both Adversity Impersonal and OVS constructions (7) are instances of ‘Generalized Inversion’ whereby the object (or any other element) is fronted to spec TP to check the EPP. However, much like Levine and Freidin (2002), Baily predicts that the fronted object in the Adversity Impersonal and OVS construction should behave like a nominative or dative subject (9) with respect to binding, but this is not borne out, as seen from the contrast between (8) and (9):

- (8) Dimu(i) uneslo v \*svojej(i) lodke  
 Dima-acc carried away in self’s boat  
 Dima was carried away in his own boat
- (9) Dime(i) strashno v svojej(i) kvartire  
 Dima-dat fears in self’s apartment  
 Dima feels scared in his own apartment

Furthermore, as Levine and Freidin (2002), Baily’s proposal does not exclude the appearance of agentive verbs in Adversity Impersonal constructions. Finally, Baily (2001, 2003) does not address the Relativized Minimality / MLC problem (Rizzi 1990, Chomsky 1995) posed by OVS constructions in (7) to which he offers the same analysis as to (1). In particular, he does not explain why the Minimality-violating movement of the object over the overt subject should be allowed in this construction. So, the challenge posed by the Adversity Impersonal construction and the even stronger challenge posed by the OVS construction remains: how and why does the object move over the subject and where does it wind up?

## 2. The Proposal

### 2.1 Some background on the syntax of adversity impersonals

In order to explain the trigger for object-fronting in (1) and its ultimate position, we must first consider the initial syntax of (1) prior to object movement. Following Pytkannen (2002), I argue in Markman (2004) that (1) involves a head Caus that introduces a causing event, but lacks a v (Voice in the sense of Kratzer 1995) that assigns the ‘agent’ theta-role. Hence the Adversity Impersonal construction is obligatorily non-agentive. Below I review some evidence to that effect. First, the construction is incompatible with an agentive by-phrase (10b). Second, it disallows control into purpose clauses (10a). In this

regard, the Adversity Impersonal construction differs from what we see in the passive construction (11) that allows both control into purpose clauses and agentive by-phrases:

- (10) a. Lodk-u sozhglo (\* Dim-oj) / molni-jej  
 boat-acc burned-3rdNeutSg Dima-instr / lightning-instr  
 The boat got incinerated by Dima / by lightening
- b. \*Lodk-u sozhglo chtob poluchit' straxovku  
 boat-acc burned-3rdNeutSg collect-inf insurance  
 The boat got incinerated to collect the insurance
- (11)a. Lodka byla sozhena chtob poluchit' straxovku  
 boat-nom was burned-3rdFemSeg in order to collect insurance  
 The boat was burned to collect the insurance
- b. Lodka byla sozhena vladel'ts-ami / molni-jej  
 boat-nom was burned-3rdFemSeg owners-instr / lightening-instr  
 The boat was burned by the owners/ by lightening

Third, the Adversity Impersonal construction is also impossible with inherently agentive verbs (12b), again, unlike the passive construction (12a):

- (12) a. Knig-a byl-a prochitan-a b. \* Knig-u prochital-o  
 Book-nom was-fem read-fem \* Book-acc read-neut  
 The book was read The book got read

However, the presence of a causing event is supported by (13) – an expression such as “on its own” is not possible in the Adversity Impersonal construction:

- (13) Dim-u ubil-o a (\* sam / sam-o po sebe) /b (mgnovenno)  
 Dima-acc killed-neut (\*alone-masc / alone-neut by self) / (instantaneously)  
 Dima got killed (\*on his own/on its own) / (instantaneously)

Thus, (1) involves a causing event introduced by a head Caus (Pylkannen 2002) that licenses accusative case, but lacks a theta-role. The structure of (1) is (14).

- (1) a. Lodk-u unesl-o b. Dim-u ubil-o  
 boat-fem.acc carried3rdSgNeut Dima-masc.acc killed3rdSgNeut  
 the boat got carried away Dima got killed

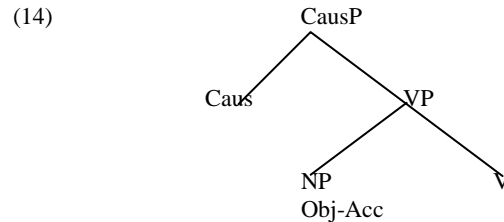

## 2.2 Cyclic spell-out and spell-out domains

To address the question of how the object goes from being in spec VP (14) to being fronted over the verb, I turn to the idea of cyclic spell-out and PF-linearization discussed in Fox and Pesetsky (2004) (F&P 2004). Fox and Pesetsky (2004) propose following Chomsky (2000, 2001) that spell-out applies to sub-parts of a derivation referred to as a Spell-out Domains (S-ODs). Once the S-OD is shipped to PF and linearized, the established relative linear order between elements must be preserved in subsequent spell-out domains (F&P 2004, p.5). If the order is undone by movement in the course of the derivation, it must be re-established before the CP is spelled-out. Otherwise, an ordering contradiction would arise, crashing the derivation. In addition, building on Fox and Pesetsky (2004), I argue that (a) the VP is the smallest spell-out domain<sup>1</sup>, and (b) the VP is crucially linearized together with its spec. With this in mind, (15) is a linearization of the VP in (1) where c-command translates into linear precedence (F&P2004).

(15) [VP [ NP(Dima-acc) V(killed)]]

However, when the V combines with Caus, the order is changed to VO (16).

(16) [CausP [ V<sub>k</sub>-Caus(killed) [NP (Dima-acc) t(k)]]]

If the OV order is not re-established, the derivation will crash due to an ordering contradiction (F&P2004). Order Preservation, thus, triggers the movement in (1). (See also Mueller (2001, 2006) for arguments that Shape Conservation (Williams 1999) can serve as a possible trigger for movement). This answers the question in (a) – why is the object fronted in the Adversity Impersonal construction. Once we have established that the object has to be moved higher than the verb, we are still left with the question of where it moves to. (This is the question in (b)). Here we have a number of options: (a) the object moves to spec TP – nothing prevents this in principle, but we have empirical evidence against this option (binding). (b) the object moves to some TP-adjoined or a CP position (A'- movement) - there is evidence against that too (scope). (c) another phrase containing just the object, and nothing else, moves to spec TP.



The option in (c) is the right and only choice: what moves to spec TP is the remnant VP that contains nothing else but the object in its spec (17).

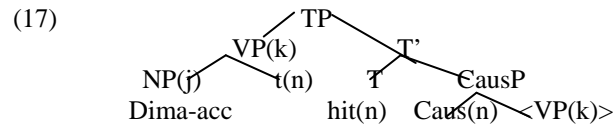

In the representation above, the EPP is satisfied by the VP; no null expletive is needed. Crucially, subject-anaphor binding is not possible because the NP in the spec of VP is too deeply embedded to bind the anaphor. The scope facts in (6) are also explained: the VP containing the object can reconstruct. That depth of embedding affects binding is independently seen in (18a) where the NP inside a CP cannot bind the anaphor and the pronoun must be used instead (18b).

(18)a.\* [Chto Dima(i) ubil Mash-u] stalo izvestno na svojem(i) dne rozhden'ji  
 [That Dima killed Masha-acc] became known at self's birthday  
 That Dima killed Masha became known at his (Dima's) birthday

b. [Chto Dima(i) ubil Mash-u] stalo izvestno na ego(i) dne rozhden'ji  
 [That Dima killed Masha-acc] became known at his birthday  
 That Dima killed Masha became known at his (Dima's) birthday

The answer to question (b) – where the object winds up – is, thus, surprising: the object actually remains in situ. It is the VP containing the object that moves to spec TP!

### 3. Remnant movement and the OVS orders

#### 3.1 OVS constructions

We can now extend the account of (1) to explain object fronting in the OVS construction in (7), repeated below:

(7) Dimu udaril Misha  
 Dima-acc hit-3rdSgMsc Misha-Nom  
 MISHA hit Dima (obligatory focus on 'Misha')

The object in (7) is not in spec TP (contrary to Bailyn 2003). Recall, it cannot bind the anaphor (19), which is bound from a subject position: spec TP, vP, or PredP (cf Harley 1995,2006 on multiple subject positions).

- (19) Dimu(j) ubil Misha(i) v svojej(i/\* j) kvartire  
 Dima-acc killed Misha-nom in self's apartment  
 Misha(i) killed Dima(j) in his(i) apartment

In addition, moving the object to spec TP in (7) should be ruled out by Minimality. Yet, the fronted object is not adjoined: it does not show frozen scope (20).

- (20) Odnogo / kakogo-to mal'chika videla kazhdaja devochka  
 One / some boy-acc saw every girl-nom  
 Every girl saw some boy (Every > Some; Some > Every)

To account for (7), I modify Fox and Pesetsky's proposal and argue that some languages can spell-out either the VP or vP even in the presence of v<sup>2</sup>. While choosing the vP as an S-OD yields SVO orders, spelling-out the VP yields OV(S) orders. Arguably, having this choice is what allows a language to have certain short-scrambled orders<sup>3</sup>. In (7), the remnant VP moves to spec TP (21) to preserve the OV order, which explains the binding and the scope facts in (19) and (20). Unlike (17), in (21) the VP 'smuggles' the object over the subject in the sense of Collins (2005a,b).

- (21)
- 
- ```

graph TD
    TP --> VPk[VP(k)]
    TP --> T_prime[T']
    VPk --> NPj[NP(j)]
    VPk --> tn[t(n)]
    NPj --- Dima[Dima-acc]
    tn --- killed[killed(n)]
    T_prime --> T[T]
    T_prime --> vP[vP]
    T --- killed2[killed(n)]
    vP --> NPi[NP(i)]
    vP --> VPk2[<VP(k)>]
    NPi --- Misha[Misha-nom]
  
```

To explain how a Minimality violation is avoided in (21), we must take a brief look at how 'smuggling' (defined (22)) works.

- (22) "Suppose a constituent YP contains XP. Suppose XP is inaccessible to Z because of the presence of W (a barrier). If YP moves to a position c-commanding W, we say that YP smuggles XP past W."

Collins (2005a,b)

In our case, the YP is the VP; the XP is the NP(object); the Z is spec TP; the W (barrier) is the NP(subject). By moving the VP to spec TP, we smuggle the object NP past the barrier– the subject<sup>4</sup>. Since the VP and the NP are not the same categories, there is no Relativized Minimality violation.

### 3.2 The impersonal "they" construction and OVS

The account of OV(S) constructions can be extended to the agentive impersonal "they" construction, where the object is also fronted over the obligatorily present

null subject. The construction in (23a) is different from the Adversity Impersonal in that it is necessarily agentive, not just causative. The agent is arguably a *pro*(arb) that occupies the same syntactic position as any agent argument – spec vP. (For extensive discussion on the semantics and pragmatics of arbitrary *pros* see Malamud 2006). Unlike the Adversity Impersonal construction, (23a) is incompatible with any *by*-phrase; agreement is 3rdPL, triggered by the *pro*(arb) subject, not default. The structure for (23a) is (23b)

- (23)a. Dimu ubili (chtob poluchit' straxovku) / (\*molni-jej)  
 Dima-acc killed-3rdPL to collect insurance lightning-instr  
 They killed Dima in order to collect insurance / by a lightning

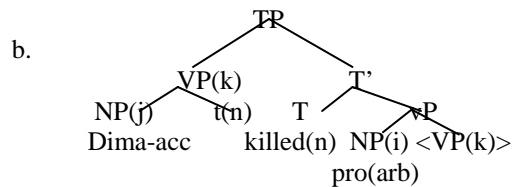

The impersonal “they” construction receives the same analysis as the other OV(S) constructions: the VP containing nothing but the object is fronted to spec TP in order to restore the initial OV order created by spelling out the VP. As a result, the object cannot bind a subject oriented anaphor, as shown in (24a):

- (24) a. Dimu(i) ubili v \*svojej(i) / ego(i) kvartire  
 Dima-acc killed-3rdPL in self's his apartment  
 They killed Dima in his own apartment

- b. Dima(i) byl ubit v svojej(i) /\*ego(i) kvartire  
 Dima-nom was killed in self's his apartment  
 Dima was killed in his own apartment

(24a) contrasts sharply with the passive construction in (24b), indicating that while the object *is* in spec TP in the passive construction (24b), it is not in the impersonal “they” construction (24a).

### 3.3 Pragmatic effects in OV(S) constructions – a pragmatic interlude

An important consequence of choosing the VP as an S-OD in the presence of *v* is that the post-verbal subject receives primary nuclear stress due to being the right-most visible element in the tree. Hence, the subject gets obligatorily focused (Chomsky and Halle 1968; Zubizarreta and Vergnaud 2000).

Unlike the Adversity Impersonal and the agentive impersonal ‘they’ constructions which involve no overt subject, or a subject-initial SVO order achieved by spelling-out the vP, (7) / (25) is pragmatically marked. The OVS construction (25) cannot be used to answer a question such as “what happened?” The primary nuclear stress that falls on the post-verbal subject in (25), causing it to be focused results in infelicity in this case. The construction is acceptable if there is a prior mention of the boat being stolen by someone.

(25)# Lodku ukral Dima  
 Boat-acc stole Dima  
 DIMA stole the boat (it was Dima who stole the boat)

In contrast, the inverted order in the Adversity Impersonal and impersonal “they” constructions (26a,b) is actually pragmatically neutral and can be used to answer the question “what happened?” In fact, it is the VO order in (26) that is pragmatically marked.

- (26) a. Lodk-u uneslo /#uneslo lodk-u [AVERS. IMPERSNL]  
 Boat-acc carried away carried-away boat-acc  
 The boat got carried away
- b. Lodk-u ukrali /# ukrali lodk-u [IMPERSNL ‘THEY’]  
 Boat-acc stole-3rdPIPast / stole-3rdPIPast boat-acc  
 They stole the boat / they stole the boat

Thus, the absence of an overt subject in the post-verbal position in Adversity Impersonal constructions (26a) and impersonal “they” constructions (26b) makes the OV order pragmatically neutral, unlike what we see in OVS constructions with overt subjects (25).

## 4. Extensions: OVS in Bantu

### 4.1 OVS in Bantu

The proposal can be further extended to account for the properties of the OVS construction in Kirundi<sup>5</sup> (27) discussed extensively in Ndayiragije (1996). In (27), the post-verbal subject is also obligatorily focused, much like what we see in Russian:

(27) Ivyo bitabo bi-a-somye Yohani  
 Those books 3pl-pst-read-perf John  
 JOHN read those books (KIRUNDI; Ndayiragije 1996)

Yet, the OVS construction in Kirundi involves an additional problem: not only does it have a minimality-violating movement of the object over the overt subject, it has agreement with the fronted object, unlike Russian, suggesting that the object is actually in spec TP (Ndayiragije 1996, Baker 2003). Ndayiragije (1996) argues that the object in (27) moves to spec TP over the subject without violating Relativized Minimality because the subject first moves to the spec of a TP-internal focus position, FocP, which is an A-bar position. However, this claim is problematic on several grounds. First, moving the subject to a spec of a TP-internal focus position prior to moving the object to spec TP is counter-cyclic and should be blocked. Second, positing a TP-internal focus position is not necessary: the obligatory focus of the subject can be explained by its clause-final position.

The current proposal explains (27) by minimally amending the account of (7): to preserve the order established by spelling-out the VP, the VP-remnant moves to a vP-adjoined position, smuggling the object past the subject. The object subsequently moves out of the VP to spec TP as shown in (28).

(28) [TP Ob\*(j) T [vP [VP(k) t(j)] [vP Subj(i) <VP(k)> ]]]

Clearly, (28) raises the question why the object is allowed to be fronted to spec TP in Bantu, but not in Russian. I turn to this question in the next section.

#### 4.2 Russian vs. Bantu

OVS constructions of the Bantu type are quite rare. To answer this question I would like to invoke an Agreement Parameter (29) proposed in Baker (2003).

(29) **An Agreement Parameter:** In Indo-European languages, the T agrees with the nominative XP. In Bantu, the T agrees with the XP in its specifier (Baker 2003, p.121).

The reason for this, Baker argues, is that the agreement features (phi-features) on T are bundled with the EPP feature in Bantu, but not in Indo-European languages. In the latter, the phi-features are bundled with the nominative case feature. So, an XP can merged /moved into spec TP in Bantu iff XP checks phi-features on T. If so, then a VP cannot appear in spec TP in Bantu because it lacks phi-features<sup>6</sup>. Combining what was said above with Baker's Agreement Parameter, the following picture emerges. Bantu OVS constructions require two movements: (1) the VP must move to a vP-adjoined position, smuggling the object past the subject. (2)The object has to be moved out to spec TP for agreement<sup>7</sup>. Russian, on the other hand, tolerates non-agreeing XPs in spec TP, hence moving the VP to spec TP is enough. Two movements would be counter-

economical. Hence, the object itself never moves to spec TP in Russian. Importantly, the T can't agree downward with the object (before the VP is moved) because the subject is a closer target for agreement. This explains subject agreement in Russian OVS constructions.

## 5. Conclusion

In sum, I have argued that OV(S) constructions involve a remnant movement of the VP to spec TP, triggered by the need to preserve the OV order established by spelling out the VP. The proposal explains the properties of OV(S) orders in the Adversity Impersonal and impersonal “they” constructions as well as in the OVS construction with an overt subject in Russian. I have then extended the account to Bantu with minor modifications. In particular, I have shown that the differences between Russian and Bantu OVS constructions are derivable from the independently motivated Agreement Parameter proposed in Baker (2003). The parameter requires any XP in the spec of TP in Bantu to agree with the verb. As a result, the VP cannot be fronted to the spec TP; the subject has to be smuggled out of the VP (in the sense of Collins 2003) and into spec TP. Since Russian (along with other Indo-European languages) does not require that only agreeing XPs appear in spec TP, such a smuggling operation would be counter-economical and hence blocked. The following typology of OV(S) constructions, thus, emerges from the proposal (30):

(30)

OV(S) Adversity Impersonal	OV(S) Impersonal “they”	OVS Russian (with overt subj.)	OVS Bantu (with overt subj.)
Move VP to spec TP (re-establish the OV order)	Move VP to spec TP (re-establish the OV order); the object is smuggled past the pro(arb) subject	Move VP to spec TP (re-establish the OV order); the object is smuggled past the overt subject	Move VP to a vP-adjoined position (re-establish the OV order); move the object out of the VP to spec TP for agreement
No “pragmatic” effect	No “pragmatic” effect	The overt subject is focused	The overt subject is focused

Finally, the data presented here indicates that OV(S) constructions, and by hypothesis other short-scrambled orders, cannot be instances of PF-movement that happen post-spell-out. There are clear syntactic and interpretational

consequences of these movements. The same conclusion is independently reached in Holmberg (2000) regarding stylistic fronting in Scandinavian.

## Notes

---

\* I would like to thank Mark Baker for interesting discussions on the topic. I would also like to thank the participants in WECOL 2006 for their useful comments and input, as well as my colleagues at the Department of Linguistics and Cognitive Science at Pomona College for their support and interest in my work. Last, but not least, I would like to thank Sophia Malamud for her suggestions, comments, and important editorial help. All the mistakes and shortcomings are, of course, my own.

<sup>1</sup> Though the object may be merged as a complement of V, it moves to spec VP for theta-assignment, crucially prior to spell-out. Hence, the resulting initial order of the VP is OV, not VO. Also, Fox and Pesetsky (2004) distinguish between spell-out domains and phases in the sense of Chomsky (2001), but this distinction is not relevant for my purposes. I will simply adopt the terminology Fox and Pesetsky (2004) use.

<sup>2</sup> The assumption that VPs can be SO-Ds is needed for the treatment of unaccusative constructions, unless we want to say that they are always spelled-out as CPs. (Though see Mueller 2006 for an argument against treating a VP as a phase/spell-out domain)

<sup>3</sup> While deriving other short-scrambled orders extends beyond the scope of the current discussion, I would like to note that we can get a variety of short-scrambled word orders by manipulating the relative timing of spell-out, merge, and XP-movement. For example, if we choose to spell-out the VP, not the vP, we can get: OVS and SOV orders, since the relative position of the subject does not matter. What matters crucially is that the relative ordering between the object and the verb remain the same (OV) throughout the derivation. Furthermore, the object can move out of the VP prior to spell-out, e.g. [VP [NP(obj) V]] becomes [NP(i) [VP [t(i) V]]]. When the VP is spelled-out, the output visible at PF contains just the V. Hence, at the end of the derivation when the CP is spelled-out (after the subject is merged) we can get the order: [O [S [.V..]]. The logic of permuting the ordering of spell-out and move operations is a powerful tool and yields a wide range of word orders. Clearly, allowing such permutations raises an important question, such as how do we constrain them. Finally, the proposal that the VP moves leaving its head below raises a question whether such headless phrasal movement should be allowed. At this point I am not aware of any specific principles of grammar that would disallow it, but such movement may raise conceptual issues at a closer investigation. I leave these questions as important open issues for future research.

<sup>4</sup> Briefly returning to the Adversity Impersonal construction (1), the above analysis can be applied to it as well if we assume that spec CausP actually has some kind of an inanimate argument over which the object is moved. There are reasons not to adopt this alternative: the construction involves an optional 'by-phrase' which is never allowed with agentive transitive constructions. This indicates that there is a deeper difference between the syntax of (1) and that of a transitive agentive construction that cannot be reduced to a difference in the v/caus head involved.

<sup>5</sup> For discussion of OVS constructions in other Bantu languages see Ura (2000) references therein.

<sup>6</sup> In this regard the VP is unlike a locative PP that can appear in spec TP in locative inversion. See Bresnan and Kanerva (1989) for arguments that locative phrases do have phi-features.

<sup>7</sup> This argument presupposes that agreement is spec-head at least in some languages. I refer the reader to Koopman (2001) and Baker (2006) for arguments in favor of spec-head agreement in Bantu.

---

## References

- Babby, Leonard H. 1989. "Subjectlessness, External Subcategorization, and the Projection Principle", *Zbornik Matice Sprske za Filologiju i Lingvistiku* XXXII/ 2, pp.7-40
- Babby, Leonard H. 1993a. "A Theta-theoretic Analysis of Adversity Impersonal in Russian". *FASL 2: The MIT Meeting*.
- Babby, Leonard H. 1993b. "Impersonal forms of the verb in Russian." Paper delivered at the 1993 AATSEEL Winter meeting (Toronto). Avrutin, S., Franks, S. and Progovac, L. (eds.) Ann Arbor: Michigan Slavic Publications
- Baker, Mark. 2003. "Agreement, dislocation, and partial configurationality." Rutgers University, Ms
- Baker, Mark. 2006. *The Syntax of Agreement and Concord*. Cambridge University Press.
- Bailyn, John. 2001. "Inversion, dislocation and optionality in Russian." in Uwe Junghans and Gerhilde Zybatow (eds.) *Formale Slavistic 3*, University of Leipzig.
- Bailyn, John. 2003. "A (purely) derivation approach to Russian scrambling." in *Proceedings of FASL 11*, UMASS, Amherst.
- Bresnan, Joan and J. Kanerva (1989). "Locative inversion in Chichewa: a case study of factorization in grammar." *Linguistic Inquiry* 20: 1- 50.
- Chomsky, Noam and M. Halle. 1968. *The Sound Patterns of English*. New York: Harper and Row.
- Chomsky, Noam. 1995. *The Minimalist Program*. Cambridge: MIT Press.
- Chomsky, Noam. 2000. "Minimalist Inquiries: the framework." *Step by Step: Essays on Minimalist Syntax in Honor of Howard Lasnik*, ed. Roger Martin, David Michaels, and Juan Uriaguereka, 89 – 155. Cambridge, Massachusetts: MIT Press.
- Chomsky, Noam. 2001. "Derivation by phase." In Michael Kenstowicz (ed.), *Ken Hale: a life in language*. Cambridge, MA: MIT Press, pp.1-52.
- Collins, Chris. 2005a. "A smuggling approach to raising in English." *Linguistic Inquiry* 36. 2: 289-298.
- Collins, Chris. 2005b. "A smuggling approach to the passive in English." *Syntax* 8.2: 81-120.
- Fox, Danny and D. Pesetsky. 2004. Cyclic linearization of syntactic structure. Ms., MIT.
- Harley, Heidi. 1995. *Subjects, Case, and Licensing*. Ph.D. Dissertation, MIT.
- Harely, Heidi. 2006. On the causative construction. Ms., University of Arizona.
- Holmberg, Anders. 2000. "Scandinavian stylistic fronting: how any category can become and expletive." *Linguistic Inquiry*, 31. 2: 445-483
- Koopman, Hilda. 2001. "The locality of agreement and the structure of the DP in Maasai". University of California Los Angeles, Ms.
- Kratzer, Angelika. 1995. "Severing the external argument from its verb." In J. Rooryck and L. Zaring (eds.) *Phrase Structure and The Lexicon*. Dordrecht (Kluwer Academic Publishers).
- Lavine, James and R. Freidin. 2002. "The subject of defective T(ense) in Slavic." *Journal of Slavic Linguistic* 10:253 89.
- Malamud, Sophia. 2006. Semantics and pragmatics of arbitrariness. Doctoral Dissertation, University of Pennsylvania.



- 
- Markman, Vita G. 2004. "Causatives without causers and Burzio's Generalization". in *NELS 34 Conference Proceedings*, Stony Brook, pp. 425-440
- Mueller, Gereon. 2001. "Two types of remnant movement." Ms., Universitat Leipzig.
- Mueller, Gereon. 2006. "Towards a relativized concept of cyclic linearization." Ms., Universitat Leipzig.
- Ndayiragije, Juvenal. 1996. "Case checking and OVS in Kirundi" in *Essays on structure and interpretation*, ed. A-M. di Sciullo, 267-292. Somerville, Mass.: Cascadilla Press
- Pylkkanen, Liina. 2002. *Introducing Arguments*. Ph.D. Thesis, MIT
- Rizzi, Luigi. 1990. *Relativized Minimality*, MIT Press, Cambridge, Mass.
- Tsedryk, Egor. 2003. "Case and agreement in Russian adversity impersonal constructions". Presented at FASL 12, University of Ottawa.
- Ura, Harioku. 2000. *Checking theory and grammatical functions in Universal Grammar*. Oxford University Press, NY.
- Williams, Edwin. 1999. *Economy as Shape Conservation*. Ms., Princeton University.
- Zubizarreta, Maria Luisa and J-R Vergnaud. 2000. *Phrasal stress, Focus, and Syntax*. Ms., University of Southern California.

Vita G. Markman  
Pomona College  
Department of Linguistics and Cognitive Science  
185 E. 6<sup>th</sup> Street  
Claremont, CA 91711  
vita\_markman@pomona.edu

# “Not-so-propositional” Islands and Their Implications for Swiping\*

Chizuru Nakao<sup>1</sup> and Masaya Yoshida<sup>2</sup>  
 University of Maryland, College Park<sup>1</sup> and  
 Northwestern University<sup>2</sup>

## 1 Introduction

Merchant (2001) introduces a new perspective on the nature of island constraints. He argues that islands are classified into several subtypes such as PF islands and propositional islands (PIs). Violations of PF-islands are repaired under PF deletion, while PIs do not employ such a PF-amelioration strategy<sup>1</sup>. The aim of this study is to establish the claim that PIs should also be subsumed under PF-islands, contrary to this view. We base our argument on the observation that violation of PIs is repaired by sluicing in the same way as PF-islands. At the same time, we demonstrate that sluicing does not ameliorate ECP violations. Given that the ECP is an LF constraint (Huang 1982), the irreparability of ECP violations follows naturally from Merchant’s view on deletion, i.e., PF violations are repaired by PF deletion while LF violations are not.

Sluicing has traditionally been analyzed as wh-movement followed by IP-deletion, as illustrated in (1) (Ross 1969; Merchant 2001; Lasnik 2001, among others: cf. Chung et. al. 1995).

- (1) John talked to someone, but I don’t know [<sub>CP</sub> **who**<sub>i</sub> [<sub>IP</sub> ~~John talked to t<sub>i</sub>]~~].

We observe at least four subtypes of sluicing with respect to the kind of the sluiced wh-phrase: *argument sluicing* ((2a): sluicing of an argument wh-element such as *who* or *what*), *adjunct sluicing* ((2b): sluicing of an adjunct wh-element such as *why* or *how*), *pied-piped sluicing* ((2c): sluicing of a PP such as *with what*), and *swiping* ((2d): PP sluicing with the preposition and the wh-word inverted as in *what with*. See Ross 1969; Rosen 1976; Kim 1997; Merchant 2002; van Craenenbroeck 2004, among others).

- (2) a. John fixed the car with something, but I don’t know **what**.  
 b. John fixed the car {in a certain way/for a certain reason}, but I don’t know **how/why**.  
 c. John fixed the car with something, but I don’t know **with what**.

- d. (?)John fixed the car with something, but I don't know **what with**.

Recently, Lasnik (2005) observes that PIs exhibit argument-adjunct asymmetry under sluicing. Argument sluicing under PIs is possible as in (3a), while adjunct sluicing is not as in (3b). This contrast points in the same direction as the well-known argument-adjunct asymmetry in island violation with overt wh-movement in Huang (1982).

- (3) a. John wants to hire [someone who fixes cars **with something**],  
but I don't know **what**.  
b. \*John wants to hire [someone who fixes cars  
{**in a certain way/for a certain reason**}], but I don't know **how/why**.

Taking this observation as the point of departure, we argue that (i) PIs are PF-islands, and that (ii) ECP violations are not remedied by sluicing because it is an LF constraint.

In section 2, we will review Merchant's (2001) analysis of PIs and show that his account does not predict the data in (3). In section 3, we will explain the asymmetry in terms of the ECP; (3b) violates the ECP even though the island violation *per se* is repaired under sluicing. Section 4 observes a similar asymmetry between pied-piped sluicing and swiping. Based on the contrast, we will propose that swiping and pied-piped sluicing should have different derivations.

## 2 Merchant (2001) on Propositional Islands

Merchant (2001) argues that PIs such as complex NPs ((5a)) should be distinguished from PF-islands such as Left Branch Condition ((4a)). Although sluicing apparently voids both types of islands ((4b) and (5b)) as is well-known since Ross (1969), Merchant gives different accounts for the two types of 'island repair' effects: The PF-island in (4b) is repaired by PF-deletion, while (5b) does not involve an island structure to begin with.

- (4) a. \***[How big]<sub>1</sub>** did she buy [a **t<sub>1</sub>** car]?  
b. She bought a big car, but I don't know **how big**.  
(5) a. \***What<sub>1</sub>** does John want to hire [someone who fixes cars with **t<sub>1</sub>**?]  
b. John wants to hire [someone who fixes cars with something],  
but I don't know **what**.

He argues that sluicing is PF-deletion of IP (Merchant 2001) and it ameliorates the PF-island violation in (4b). On the other hand, the example in (5b) is

acceptable not because the PI violation is repaired, but because it has a source that does not involve an island, as illustrated in (6).

(6) ... but I don't know **what**<sub>1</sub> [*she* fixes cars with *t*<sub>1</sub>]. (*she* = e-type pronoun)

In (6), the source of sluicing employs an e-type pronoun subject, and it does not involve any complex NPs. Because there is no underlying island, the 'repair' effect in (5b) is only apparent.

This analysis, however, does not predict the asymmetry in (3). Under Merchant's analysis, adjunct sluicing with a PI ((3b)) should be acceptable because its underlying form involves no island, as shown in (7a). (7a) is an acceptable form that involves extraction from a simple clause, just like (7b).

- (7) a. John wants to hire [someone who fixes cars for a certain reason], but I don't know **why**<sub>1</sub> [*she* fixes cars *t*<sub>1</sub>]. (*she* = e-type pronoun)  
 b. I don't know **why**<sub>1</sub> she fixes cars *t*<sub>1</sub>.

However, (3b) is unacceptable, and therefore the analysis that employs underlying e-type pronouns is hard to maintain.

### 3 Proposals

#### 3.1 The necessity of the ECP

Based on the above argument, Lasnik (2005) suggests that the type of analysis proposed by Lasnik and Saito (1984, 1992) is required for the argument-adjunct asymmetry in (3). Following this insight, we present an ECP-based account of the asymmetry in this section.

According to one of the major formulations of the ECP (Huang 1982; Lasnik and Saito 1984, 1992), an empty category must be either antecedent-governed or head-governed by a lexical head. Assuming that complex NPs are 'barriers' for antecedent government (Lasnik and Saito), the trace is not antecedent-governed in either (8a) or (8b). Since the argument trace in (8a) is lexically governed by the verb, only the adjunct trace in (8b) violates the ECP.

- (8) a. I don't know **what**<sub>1</sub> [~~John wants to hire [someone who fixes cars with *t*<sub>1</sub>]].~~  
 b. \*I don't know **why**<sub>1</sub> [~~John wants to hire [someone who fixes cars *t*<sub>1</sub>]].~~

Given that the underlying PI violation in (8a) does not cause unacceptability, the

unacceptability of (8b) cannot be attributed to a PI violation: if a PI violation is the source of the unacceptability, it should equally affect (8a). Therefore, we must conclude that (i) the PI violation in both examples is repaired by sluicing, while (ii) the ECP violation in (8b) is not, resulting in unacceptability. Consequently, we cannot maintain Merchant's dichotomy of islands anymore; PIs are PF-islands and are repaired by sluicing. Given the Y-model of the grammar architecture, this line of argument is plausible, because the ECP is originally proposed as a constraint on LF representation<sup>2</sup> (Huang 1982), while PF-islands are constraints on PF representation (Merchant 2001).

### 3.2. Extending the ECP account: a parallelism account

There is an apparent counter-argument to the ECP account. Lasnik (2005) notes that adjunct *wh*-phrases cannot escape even complement clauses under sluicing. The long-distance reading of (9) (= (9a)) is unavailable. Without sluicing, on the other hand, *wh*-movement can escape complement clauses, as shown in (10).

- (9) ?\*Mary said that John left for some reason, but I don't know (exactly) **why**<sub>1</sub>.  
 a. = ?\*I don't know [<sub>CP</sub> **why**<sub>1</sub> [<sub>IP</sub> Mary said [<sub>CP</sub> **t**<sub>1</sub>' that [<sub>IP</sub> John left **t**<sub>1</sub>]]]].  
 b. = I don't know [<sub>CP</sub> **why**<sub>1</sub> [<sub>IP</sub> John left **t**<sub>1</sub>]].  
 (10) [<sub>CP</sub> **Why**<sub>1</sub> did [<sub>IP</sub> Mary say [<sub>CP</sub> **t**<sub>1</sub>' that [<sub>IP</sub> John left **t**<sub>1</sub>]]]]?

The unacceptability of (9a) is unexpected under the ECP account, because the representation (9a) does not violate the ECP, i.e., the adjunct *wh*-trace (*t*) is antecedent-governed by the intermediate trace in the embedded [Spec, CP] (*t'*) in both (9a) and (10).

To avert the problem, we claim that the notion of Parallelism in sluicing proposed by Fox and Lasnik (2003) is necessary in addition to the ECP. They argue that a sluiced clause and its antecedent must satisfy Parallelism. For example, (12a) is the semantic representation of the antecedent clause of (11), and (12b) is that of the sluice.

- (11) Fred said that I talked to a certain girl, but I don't know **which**<sub>1</sub> [~~Fred said that I talked to **t**<sub>1</sub>~~].  
 (12) a.  $\exists f \lambda f'$ [Fred said that I talked to **f'**(girl)]  
 b. **which g girl**  $\lambda g'$ [Fred said that I talked to **g'**(girl)]

They propose that an intermediate trace destroys the parallelism of the two representations. Thus, if *which girl* moves to the surface position in one stretch, they have the same representation. Although this one-fell-swoop movement violates a locality condition (subjacency in the traditional term), it is remedied

by sluicing. If, on the other hand, the *wh*-phrase moves successive cyclically, an intermediate trace in (12b) destroys the parallelism because the representation of *a certain girl* in (12a) does not involve any intermediate step. Successive cyclic movement is thus prohibited in sluicing in terms of the parallelism requirement.<sup>3</sup> This means that even complement clauses behave like islands under sluicing.

The sluice/non-sluice asymmetry between (9a) and (10) is not problematic anymore. (14a) and (14b) represent the antecedent clause and the sluice of (13). *Why* in (13) undergoes one-fell-swoop movement for (14) to satisfy Parallelism. The subjacency violation made by this movement is remedied by PF-deletion as assumed in Fox and Lasnik. However, the long-movement causes an ECP violation at LF, because the trace of adjunct must be antecedent governed, and this requirement is not met in (13).

- (13) ?\*Mary said that John left for a certain reason,  
 but I don't know **why**<sub>1</sub> [~~Mary said that John left t<sub>1</sub>]. (=9a)~~
- (14) a.  $\exists f \lambda f'$ [Mary said that John left for **f'(reason)**]  
 b. **which g reason**  $\lambda g'$ [Mary said that John left for **g'(reason)**]

On the other hand, the non-sluiced example (10) allows successive cyclic movement. Because of the intermediate trace, it does not violate the ECP.

Given this account, the original data of argument-adjunct asymmetry can be restated using Parallelism. (16) and (18) represent the antecedent clause and the sluice of (15) and (17), respectively (repeated from (3)). Here, two clauses in (16) and (18) must satisfy Parallelism. *Wh*-movement in both examples crosses a PI (subjacency violation), but the locality violation is remedied under sluicing. Nevertheless, the adjunct *wh*-phrase in (17) causes an ECP violation, because it is neither lexically governed nor antecedent governed.

- (15) John wants to hire [someone who fixes cars with something], but I don't know **what**<sub>1</sub> [~~John wants to hire [someone who fixes cars with t<sub>1</sub>]].~~
- (16) a.  $\exists f \lambda f'$ [ $\exists h \lambda h'$ [John wants to hire h'(person) who fixes cars with **f'(thing)**]]  
 b. **which g thing**  $\lambda g'$ [ $\exists k \lambda k'$ [John wants to hire k'(person) who fixes cars with **g'(thing)**]]
- (17) \*John wants to hire someone who fixes cars for a certain reason, but I don't know **why**<sub>1</sub> [~~John wants to hire [someone who fixes cars t<sub>1</sub>]].~~
- (18) a.  $\exists f \lambda f'$ [John wants to hire someone who fixes cars (for) **f'(reason)**]  
 b. **why (what reason) g**  $\lambda g'$ [John wants to hire someone who fixes cars (for) **g'(reason)**]

Let us summarize the theoretical implications of this account. As mentioned above, our analysis has two conclusions. The first one is that sluicing remedies

PI violations (e.g. (15)) as well as subjacency violations (e.g. (11)). We do not need a distinction between PF-islands and PIs anymore; both islands are PF islands and are repaired by sluicing. The second conclusion is that sluicing cannot remedy ECP violations. Recall that Merchant claims that sluicing is PF-deletion and therefore remedies PF-island violations. Our argument makes the complementary claim: sluicing is PF-deletion and therefore does not remedy LF-violations (e.g. ECP violations). This further corroborates the PF-deletion analysis of sluicing.

## 4 Extensions: Swiping/Pied-Piping Asymmetry

### 4.1 Two types of PP sluicing

Similarly to the argument-adjunct sluicing asymmetry, two types of PP sluicing behave differently in terms of PIs. Pied-piped sluicing is constrained by PIs ((19a)), while swiping is not ((19b)).<sup>4</sup>

- (19) a. \*John wants to hire [someone who fixes cars with something],  
but I don't know **with what**.  
b. ?John wants to hire [someone who fixes cars with something],  
but I don't know **what with**.

Similarly, a long-distance reading across a complement clause is degraded in pied-piped sluicing (the reading (20a) for (20)), unlike swiping ((21a) for (21)).<sup>5</sup> The pattern suggests that pied-piped sluicing behaves like adjunct sluicing, while swiping is parallel to argument sluicing.

- (20) John claimed [that Mary fixed the car with something], but I don't know **with what**.  
a. = ?\* I don't know **with what**<sub>1</sub> John claimed that Mary fixed the car  $t_1$ .  
b. = I don't know **with what**<sub>1</sub> Mary fixed the car  $t_1$ .  
(21) John claimed [that Mary fixed the car with something], but I don't know **what with**.  
a. = ?I don't know **what**<sub>1</sub> John claimed that Mary fixed the car **with**  $t_1$ .  
b. = I don't know **what**<sub>1</sub> Mary fixed the car **with**  $t_1$ .

This asymmetry is surprising given that both of them involve the same type of wh-elements, i.e., all the examples above involve *adjunct* PPs (headed by *with*) and therefore should be subject to the ECP. Merchant (2002) analyzes swiping as pied-piped wh-movement followed by head-inversion. He claims that (22a)

results from the head adjunction of the wh-element to the preposition inside the moved PP, as illustrated in (22b).

- (22) a. (?)John danced with someone, but I don't know **who with**.  
 b. [CP [PP [P **who<sub>2</sub>+with**]<sub>I</sub> [D t<sub>2</sub>]]<sub>I</sub> [~~IP John danced t<sub>1</sub>~~]]
- 

Under this analysis, swiping in (19b) leaves an adjunct PP trace as illustrated in (23), which should cause an ECP violation. The acceptability of (19b) is thus unexpected under Merchant's (2002) analysis.

- (23) John wants to hire [someone who fixes cars with something], but I don't know [**what+with**]<sub>I</sub> [~~IP John wants to hire [someone who fixes cars \*t<sub>1</sub>]]~~.

#### 4.2 Proposal: PP shift analysis of swiping

The above data strongly indicate that swiping and pied-piping sluicing involve different derivations. To capture this difference, we propose a PP shift analysis of swiping, based on the rightward movement analysis of Kim (1997). We argue that a swiped PP undergoes rightward movement, which we call 'PP shift.' PP shift is exemplified in (24b).

- (24) a. [<sub>IP</sub> [<sub>IP</sub> John talked [<sub>PP</sub> to someone]] yesterday].  
 b. [<sub>IP</sub> [<sub>IP</sub> [<sub>IP</sub> John talked PP] yesterday] [<sub>PP</sub> **to someone**]].

Under our analysis, swiping is derived as in (25). First, the PP undergoes PP shift ((25a)). In Nakao, Ono and Yoshida (2006), we argue that this movement does not leave a trace behind, unlike wh-movement. Then, the wh-element *who* moves to the CP domain, stranding the preposition as in (25b). The inner IP is deleted at PF.

- (25) a. [<sub>IP</sub> [<sub>IP</sub> John danced PP] [<sub>PP</sub> **with who**]]  
 b. [<sub>CP</sub> **who**<sub>I</sub> [<sub>IP</sub> [~~IP John danced PP~~] [<sub>PP</sub> with t<sub>1</sub>]]]
- 

If there is no trace left by the PP movement, the only trace left in (25b) is the trace of *who*, which is lexically governed by the preposition. Therefore, it does not violate the ECP, unlike adjunct/pied-piped sluicing. Now let us turn to our argument on the status of PP-shift.

#### 4.3 PP shift as a trace-free operation

Let us review one of the pieces of evidence that PP shift does not leave a trace (Nakao, Ono and Yoshida 2006: See also Tanaka 2005 for a similar proposal) in



this section. Lasnik (1984) points out that PP shift does not block contraction. Look at the paradigm in (26).

- (26) a. John **is/'s** in the room (now).  
 b. I don't know where<sub>i</sub> John **is/\*'s** t<sub>i</sub> (now).  
 c. John **is/'s** t<sub>PP\_NOW</sub> [<sub>PP</sub> in the room].

One observation on the distribution of 's is that the clitic 's needs to have a morphologically realized category *on its right* (Bresnan 1971; Boeckx 2000). This explains the fact that contraction is possible in (26a) and not in (26b); in (26b), the *wh*-trace on the right side of the copula blocks contraction. On the other hand, in the case of PP shift, the contraction is not blocked as shown in (26c). This naturally follows under the assumption that PP shift does not leave a trace.

Under the assumption that PP shift does not leave a trace, the derivation we proposed in (25) successfully explains the fact that swiping is not constrained by PIs or complement clause. The trace of *who* left in (25b) is lexically governed by the preposition and does not cause an ECP violation even inside a PI or a complement clause.

However, there is a potential problem with this derivation: the derivation of (25) violates derived position islands (Wexler and Culicover 1980; Takahashi 1994; Merchant 2001).<sup>6</sup> Our proposal requires the *wh*-phrase to move out of the shifted PP, but such movement is usually banned by derived position island, as shown in (28).

- (28) a. \*<sub>[CP Who<sub>i</sub> did [<sub>IP</sub> [<sub>IP</sub> you talk \_PP yesterday] [<sub>PP</sub> **to** t<sub>i</sub>]]]?  
 b. \*I don't know [<sub>CP</sub> who [<sub>IP</sub> [<sub>IP</sub> you talked \_PP yesterday] [<sub>PP</sub> **to** t<sub>i</sub>]]]?</sub>

To solve this problem, we speculate that the *wh*-movement in swiping and movement in (28) are different: the *wh*-feature of *who* in (25) is satisfied by head-movement onto C, instead of phrasal movement into [Spec, CP]. We further conjecture that only phrasal movement is constrained by derived position islands. This assumption keeps the derivation of swiping in (25) intact. This analysis is compatible with the observation that only minimal *wh*-elements (which are presumably heads) allow swiping, but not complex *wh*-elements ((29): Merchant 2002; Van Craenenbroeck 2004).

- (29) John danced with some girl, but I don't know (?)**who with/\*which girl with.**

With these assumptions, the modified PP shift analysis is illustrated in (30).<sup>7</sup>

- (30) a.  $[_{IP} [_{IP} \text{John danced } \_PP] [_{PP} \text{with who}]]$  PP shift  
 b.  $[_{CP} \text{who}_1 + C^0 [_{IP} [_{IP} \text{John danced } \_PP] [_{PP} \text{with } t_1]]]$  head-movement  
 c.  $[_{CP} \text{who}_1 + C^0 [_{IP} \text{John danced } \_PP] [_{PP} \text{with } t_1]]$  IP-deletion at PF

Note that non-sluciced wh-questions should not allow such a derivation; otherwise sentences in (28) would also escape derived position islands by head-movement. We claim that the existence of I-to-C movement blocks head-movement onto C in non-sluciced wh-questions. (We assume covert I-to-C for embedded wh-questions for (28b).) On the other hand, sluicing is incompatible with I-to-C, even in a matrix clause as in (31) (Merchant 2001; Lasnik 2001).<sup>8</sup>

- (32) a. A: John will meet someone.  
 B: \*Who **will**?/\*I don't know who **will**.  
 b.  $[_{CP} \text{Who will } [_{IP} \text{John } t_{\text{will}} \text{ meet}]]?$

Because of the lack of I-to-C movement,  $C^0$  is available for head-movement *only in sluicing*. This enables the head movement (30b) in swiping.

## 5 Conclusion

Investigating the adjunct extraction out of PIs under sluicing, we proposed that the ECP, combined with Fox and Lasnik's (2003) Parallelism analysis, is necessary to account for the behavior of adjunct wh-elements under sluicing. Our main claims are that (i) island violations including those of PIs are repaired under sluicing, while (ii) ECP violation is not. Consequently, PIs must be PF-islands, contra Merchant's (2001) dichotomy of islands. The second claim, on the other hand, is well-motivated by Merchant's claim that sluicing involves PF-deletion; the ECP is an LF constraint (Huang 1982) and it should not be affected by PF-deletion. Moreover, observing ECP violation under sluicing itself provides yet another argument for Merchant's claim that sluicing has an underlying CP structure. If sluicing consists of just a fragment DP (Riemsdijk 1978; Ginzburg 1992), there should not be any underlying structure to violate the ECP. Thus this study supports the position that sluicing represents a full-fledged structure.

We have also seen that swiping, unlike pied-piped sluicing, is not constrained by the ECP. This is accounted for by the PP shift analysis of swiping, combined with the assumption that PP shift does not leave a copy.

## Notes

\* We would like to express our gratitude to Norbert Hornstein, Howard Lasnik, Jeff Lidz, Juan Uriagereka, the audience of the Syntax Lunch Meeting at University of Maryland, and the audience of WECOL 2006 for their valuable comments and discussion. We would also like to thank the grad student informants at University of Maryland for providing us judgments on English sentences.

1 PIs are defined as “extraction out of a propositional domain.” He does not discuss the exact status of PIs, but his tacit assumption seems to be that they cannot be repaired by PF-deletion. See Section 2.

2 Lasnik and Saito (1992) argue that the ECP is applied at S-structure and LF for argument traces and only at LF for adjunct and intermediate traces. This asymmetry is proposed to exclude (i) as a *that*-trace violation at S-structure, while including (ii) and (iii) using *that*-deletion at LF.

(i) \*Who<sub>i</sub> do you think [that [t<sub>i</sub> left]]?

(ii) Why<sub>i</sub> do you think [that [John left t<sub>i</sub>]]

(iii) Who<sub>i</sub> do you think [that [Mary said [ t'<sub>i</sub> [ t<sub>i</sub> won the race]]]]?

Merchant (2001) claims that the *that*-trace effect is a type of PF-island and is remedied by sluicing. In sum, (i) is an S-structure violation for Lasnik and Saito and a PF violation for Merchant. We concentrate on ECP violation of adjunct traces *at LF*, claiming that LF violations cannot be ameliorated by sluicing.

3 A sluiced *wh*-element, however, undergoes successive-cyclic movement when the corresponding phrase in the antecedent undergoes successive-cyclic movement as in (i). See Fox and Lasnik (2003) for details.

(i) I know **which book** John said that Mary read, but YOU don't know **which one**.

4 We owe the judgment of the examples (19)-(21) to our graduate student colleagues in the syntax seminar, Fall 2006 in University of Maryland. Note that, as Rosen (1976) observes, the best cases of swiping involve so-called sprouting (swiping without an antecedent: see note 5) and some speakers find swiping with an adjunct antecedent PP slightly degraded (indicated by “?”) regardless of islands.

5 Kim (1997) claims that long-distance Swiping is impossible, based on examples such as (i).

(i) Mary claimed that the opera was written in the 19<sup>th</sup> century, but we are not sure **who by**.

a. = \*we are not sure **who** Mary claimed that the opera was written in the 19<sup>th</sup> century **by**.

b. = we are not sure **who** the opera was written in the 19<sup>th</sup> century **by**.

This is an example of sprouting, unlike our examples here. We will not discuss the contrast between swiping with and without antecedent in this paper.

6 The derivation of swiping out of an island as in (ib) seems to violate so-called Right Roof Constraint (Ross 1967) in (ii), in addition to derived position island. The rightward movement of the PP in (ib) crosses the IP inside the relative clause.

(i) a. John wants to hire someone who fixes cars **with something**, but I don't know **what with**.

b. [<sub>CP</sub> **what**<sub>i</sub>+C<sup>0</sup> [<sub>IP</sub> ~~John wants to hire~~ [<sub>PL</sub> someone [<sub>wh</sub> [<sub>IP</sub> fixes cars ~~PP~~]]]]] [<sub>PP</sub> **with** t<sub>i</sub>]

(ii) *Right Roof Constraint*: No element may be moved rightward out of the next higher S node.

We tentatively assume that Right Roof Constraint violations, as well as PF island violations, are ameliorated by sluicing. (However, see Lasnik 2005 for an argument for the opposite conclusion.)

Recall that we have seen that PP shift does not leave a trace. If Right Roof Constraint is repairable by PF-deletion, it is not amelioration of an illegitimate representation (e.g. an illegitimate trace) but amelioration of a illegitimate operation (PP shift). If our argument is on the right track, it follows that PF-deletion enables otherwise illegitimate operations that would have caused PF-violations.

7 The head-movement in (30b) does not seem to obey the Head Movement Constraint. See, however, Roberts (1994), Chomsky (1995) and Takahashi (2002) for the dubious status of the Head Movement Constraint.

8 Our analysis needs to assume there is no T-to-C movement in sluicing at all, even covertly. (cf. Pesetsky and Torrego 2001)

## References

- Boeckx, Cedric. 2000. "A Note on Contraction," *Linguistic Inquiry*, **31**: 357-365.
- Bresnan, Joan. 1971. "Contraction and the Transformational Cycle," Ms. MIT, Cambridge, MA.
- Chomsky, Noam. 1995. *The Minimalist Program*. Cambridge, MA: MIT Press.
- Chung, Sandra, William A. Ladusaw, and James McCloskey. 1995. "Sluicing and Logical Form," *Natural Language Semantics*, **3**: 239-282.
- Craenenbroeck, Jaroen van. 2004. *Ellipsis in Dutch Dialects*. Doctoral dissertation. Leiden University, Leiden.
- Fox, Danny and Howard Lasnik. 2003. "Successive-cyclic Movement and Island Repair: the Difference between Sluicing and VP-ellipsis," *Linguistic Inquiry*, **34**: 143-154.
- Ginzburg, Jonathan. 1992. *Questions, Queries and Facts: A Semantics and Pragmatics for Interrogatives*. Doctoral dissertation, Stanford University.
- Huang, C.-T. James. 1982. *Logical Relations in Chinese and the Theory of Grammar*. Doctoral dissertation. MIT, Cambridge, MA.
- Kim, Jeong-Seok. 1997. *Syntactic Focus Movement and Ellipsis: A Minimalist Approach*. Doctoral dissertation, University of Connecticut, Storrs.
- Lasnik, Howard. 1984. "Lecture 5: Further Properties of Empty Categories." A lecture at Tokyo Linguistics Seminar: A series of lectures on current issues in the theories of syntax and logical form. Tokyo.
- Lasnik, Howard. 2001. "When Can You Save a Structure by Destroying It?," *Proceedings of the 31st Annual Meeting of the Northeastern Linguistic Society*: 301-320.
- Lasnik, Howard. 2005. "How to Evade Moving Violations." Handout for a course at LSA Summer Institute. MIT, Cambridge, MA.
- Lasnik, Howard and Mamoru Saito. 1984. "On the Nature of Proper Government," *Linguistic Inquiry*, **15**: 235-289.
- Lasnik, Howard and Mamoru Saito. 1992. *Move  $\alpha$ : Conditions on Its Application and Output*. Cambridge, MA: MIT Press
- Merchant, Jason. 2001. *Syntax of Silence*. Oxford: Oxford University Press.
- Merchant, Jason. 2002. "Swiping in Germanic," Werner Abraham and Jan-Wouter Zwart

- (eds.) *Studies in Comparative Germanic Syntax*. Amsterdam: John Benjamins: 295-321.
- Nakao, Chizuru, Hajime Ono and Masaya Yoshida. 2006. "When a Complement PP Goes Missing: A Study on the Licensing of Swiping," *Proceedings of the 25th West Coast Conference on Formal Linguistics*: 297-305.
- Pesetsky, David and Esther Torrego. 2001. "T-to-C Movement: Causes and Consequences," Michael Kenstowicz (ed.) *Ken Hale; A Life in Language*. Cambridge, MA: MIT Press: 355-426.
- Riemsdijk, Henk van. 1978. *A Case Study in Syntactic Markedness: The Binding Nature of Prepositional Phrases*. Dordrecht: Foris.
- Roberts, Ian. 1994. "Two Types of Head Movement in Romance," Norbert Hornstein and David Lightfoot (eds.) *Verb Movement*. Cambridge: Cambridge University Press: 207-242.
- Rosen, Carol. 1976. "Guess What About?," *Proceedings of the 6th Annual Meeting of the Northeastern Linguistic Society*: 205-211.
- Ross, John. 1967. *Constraints on Variables in Syntax*. Doctoral dissertation. MIT, Cambridge, MA.
- Ross, John. 1969. "Guess Who?," *Papers from the 5th Regional Meeting of the Chicago Linguistic Society*: 252-286.
- Takahashi, Daiko. 1994. *Minimality of Movement*. Doctoral dissertation, University of Connecticut, Storrs.
- Takahashi, Daiko. 2002. "Determiner Raising and Scope Shift," *Linguistic Inquiry*, **33**: 575-616.
- Tanaka, Hidekazu. 2005. "Antecedent-Contained Deletion without Quantifier Raising," *York Papers in Linguistics*, **3**. University of York: 173-184.
- Wexler, Kenneth and Peter W. Culicover. 1980. *Formal Principles of Language Acquisition*. Cambridge, MA: MIT Press.

Chizuru Nakao  
 University of Maryland, College Park  
 Department of Linguistics  
 1401 Marie Mount Hall  
 College Park, MD 20742-7505  
 cnakao@umd.edu

Masaya Yoshida  
 Northwestern University  
 Department of Linguistics  
 2016 Sheridan Rd.  
 Evanston, IL 60208  
 y-masaya@ta2.so-net.ne.jp

## Agreeing and Non-Agreeing C: Evidence for C-to-T Phi-Feature Transfer

**Hamid Ouali**

University of Wisconsin-Milwaukee

### **Introduction**

In recent developments of Minimalism, Chomsky (2000, 2001, 2004 and 2005) argues that agreement results from a Probe-Goal relation established between a head X and an argument YP. Chomsky proposes that Subject-verb agreement is obtained upon establishing an Agree relation between T and the subject (in Spec-vP). T however is not merged bearing  $\Phi$ -features but inherits these  $\Phi$ -features from C. In light of this hypothesis and following Ouali (2006), this paper examines the nature of feature inheritance or Feature Transfer and its implications for the nature of agreement and the so-called Anti-Agreement Effect (AAE) (Ouhalla 1993, 2005b) in Berber. I will argue that Anti-Agreement is a case of C-Agreement obtained as a result of lack of phi-feature inheritance of T from C.

In nonfinite clauses, the assumption that T is not selected by C, and the argument that T does not have  $\Phi$ -features seem to be logical since C, from which it inherits these features, was never merged. However, the assumption that in finite clauses, when C is merged, T inherits the  $\Phi$ -features from it, is stipulative, and should in fact allow three logical possibilities:

- 1. C transfers the  $\Phi$ -features to T,
- 2. C does not transfer the  $\Phi$ -features to T and
- 3. C transfers the  $\Phi$ -features to T but also keeps a copy.

Ouali (2006) and Ouali (in progress) show, in a detailed analysis, that all these theoretically violable options are empirically attested. Let us first discuss how subject-verb agreement is obtained.

## 1. Subject-Verb Agreement

As proposed by Chomsky (2000, 2001), agreement is obtained as a result of a probe-goal relation and an Agree operation between T and the Subject. Agree is defined as follows:

(1) **Agree**

The probe P agrees with the closest Matching goal in D.

- a. Matching is feature identity
- b. D is the sister of P. [D= c-command Domain of P]
- c. Locality reduces to closest c-command

(Chomsky 2000: 122)

Consider the example (2) in represented (3):

(2) John drinks coffee

(3)

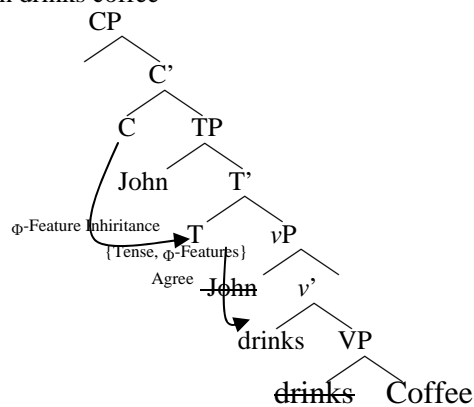

C is the locus of  $\Phi$ -features which T inherits when C is merged. T then, bearing these uninterpretable and unvalued  $\Phi$ -features probes the closest goal, the subject in this case, and agrees with it. Upon this agreement the  $\Phi$ -features on T are valued and deleted and the case feature on the DP is also valued and deleted. Why does T inherit the C's  $\Phi$ -features? Chomsky (2006) argues that this inheritance mechanism is crucial for the explanation of the A/A-bar distinction. Does C always transmit its  $\Phi$ -features to T? Can it for example not transfer these features at all or transfer them but keep a copy? I argue that this is what happens in subject extraction cases in Berber; cases where Anti-Agreement is observed.

Let us now ask another question and that is: can C keep the  $\Phi$ -features and not transfer them at all?

## 2. Subject Extraction and Anti-Agreement Effect

Verbs in Tamazight Berber (TB) are always inflected for subject agreement as shown in (4):

- (4) **th-e3la**        thamttut    araw    VSO  
**3sf-** seePERF woman boys  
 ‘The woman saw the boys’

This agreement is suppressed in Tamazight and in Berber in general when the subject is extracted, for example in Subject wh-clauses, as shown in (5). As illustrated by the ungrammatical sentence in (6), agreement is incompatible with extraction:

- (5)    mani thamttut    ag    3la-**n**                araw  
       which woman COMP see.PERF-Part    boys  
       ‘Which woman saw the boys’
- (6)    \*mani thamttut    ag    **th3la**                araw  
       which woman COMP 3sf.see.PERF    boys  
       ‘which woman saw the boys?’

The same pattern is observed in subject relative clauses as in (7) and (8), and clefts in (9) and (10) where subject verb agreement is again impossible.

- (7)    thamttut    ag                    3la-**n**                araw  
       woman    COMP                    see.PERF.Part    boys  
       ‘The woman who saw the boys...’
- (8)    \*thamttut            ag            **th-3la**                araw  
       woman                COMP 3sf-see.PERF    boys  
       ‘the woman who saw the boys...’
- (9)    thamttut-a ag            3la-**n**                araw  
       woman-this            COMP see.PERF.Part    boys  
       ‘It was this woman that saw the boys’
- (10)    \*thamttut-a            ag                    **th-3la**                araw  
       woman-this            COMP                    3sf-see.PERF    boys

How can we account for these facts given Agree theory discussed above and Chomsky proposal that C is the locus of  $\Phi$ -features which get inherited by T? Note that Agree should hold between T, which is specified for a full set of unvalued  $\Phi$ -features, and the subject, which is specified for valued  $\Phi$ -features and unvalued case feature. If full agreement is pre-requisite for case valuation and deletion, how can one derive the Berber subject extraction facts where T



presumably is not specified for a full set of  $\Phi$ -features? Consider the representation of (5) in (11):

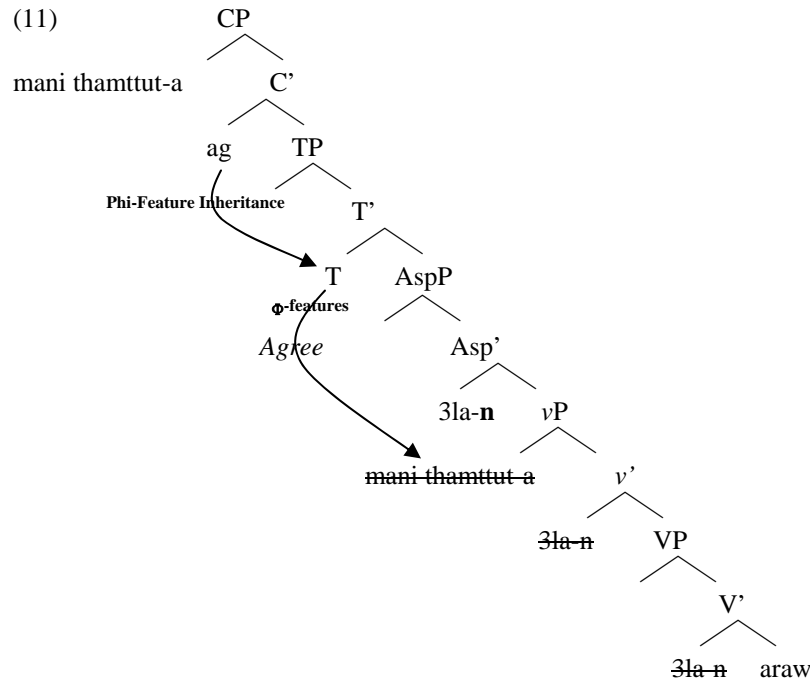

According to Chomsky's proposal, C transmits its  $\Phi$ -features to T (feature inheritance), T then agrees with the *wh*-subject; as a result of this agreement the [-interpretable]  $\Phi$ -features on T and the case feature on the subject are valued and deleted. Subject-verb agreement should obtain since the Probe-Goal between T and the *wh*-Subject C can be established prior to subject extraction; however this is not what we observe. Subject-Verb agreement is suppressed in such contexts and the question is how can we account for it?

I propose that T, in Berber, does not inherit the  $\Phi$ -features from C, in for example *wh*-clauses. When C is merged it does not transmit its [-interpretable]  $\Phi$ -features to T, and therefore remains active. T bears only [+interpretable] tense features will remain inactive.<sup>1</sup> Principles of minimal search will force the active phi-complete C to search for the closest goal, which is the active subject. As a result of Agree the  $\Phi$ -features on C are valued and the *wh*-feature on the subject is also valued. The question arises, if the  $\Phi$ -features on T are "suppressed" how does the Case feature on the DP get valued and deleted?<sup>2</sup> There is a good reason here to assume that this happens as a result of Agree with the  $\Phi$ -complete C.



The embedded C, which does not bear a wh-feature, transfers its  $\Phi$ -features to T. Up to this point the [-interpretable] wh-feature on the subject has not been valued yet. Does the derivation crash? The answer is no because the Numeration has not been exhausted yet which therefore means that there still is hope for the wh-subject. At the embedded CP level we get “T-agreement” hence full subject-verb agreement and now the wh-subject moves to the intermediate Spec-CP. Let us then examine what happens at the matrix CP level.

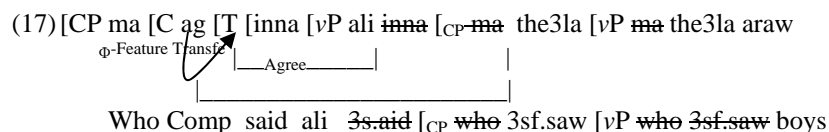

The first possible option is that the matrix C, which bears a [+interpretable] wh-feature, transfers its  $\Phi$ -features to T as represented in (17). Remember that at this point we have not valued the wh-feature of the wh-word yet. When C transfers its  $\Phi$ -features to T it will not remain active and consequently it will not act as probe and Agree with the subject. The Numeration has been exhausted, and there remains no hope for the subject yielding a fatal crash. Now there is no other solution but to try the second option by which C keeps its  $\Phi$ -Feature represented in (18).

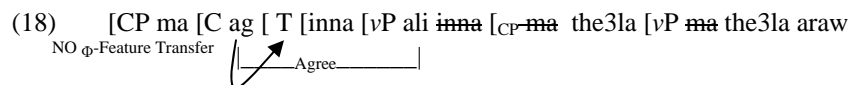

The matrix C retains its  $\Phi$ -features, and therefore is active. Minimal search forces C to search for the closest goal which is the matrix subject. Even though C bears a wh-feature, this feature, as we established before, is valued and [+interpretable], which means Agree with matrix subject would go through; C gets its  $\Phi$ -features valued and the matrix subject gets its case feature valued. Now C is inactivated and will not probe the active embedded wh-subject which is in the intermediate Spec-CP. Here again the Numeration is exhausted, no hope remains for the subject, and the derivation faces a fatal crash. Only at this stage and as a last resort do we invoke a third option, namely C transfers its  $\Phi$ -features to T but also keeps a copy. Since this is a last resort option, the derivation up to the embedded CP (lower CP phase) proceeds as explained in (16), because the Numeration at the point of the intermediate CP is not exhausted and there is still hope for the subject. As we reach the matrix CP, and as we just saw we exhaust both the first option, which is T inherits C’s  $\Phi$ -features, and the second option, by which C keeps its  $\Phi$ -features, and our last hope is a third option. Let us examine how this last option operates.

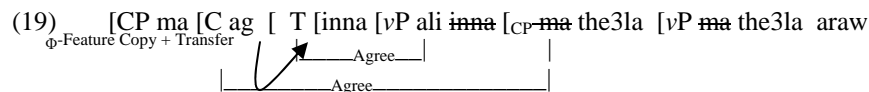

The matrix C, which bears a [+interpretable] wh-feature, transfers its [-interpretable]  $\Phi$ -features to T and keeps a copy of these features. As a result, both C and T are now active probes. Minimal search enables T to find the closest active DP, namely the matrix subject. Agree takes place, now both matrix T and matrix subject are inactive and “T-agreement” is obtained. C, still active, probes the closest active DP, which is the embedded wh-subject in intermediate Spec-CP. Again, Agree takes place, the  $\Phi$ -features on C are valued as well as the wh-feature on the wh-subject. Now the derivation converges.

This analysis makes a very strong prediction and that is: an “agreeing” C i.e. a C that does not transmit its  $\Phi$ -features to T, should be different from a non-agreeing C i.e. a C that transmits its  $\Phi$ -features to T. This is exactly what we observe in Tamazight Berber and in Berber in general. In local extraction contexts such as (20) Comp is obligatory otherwise the sentence becomes ungrammatical as in (21):

- (20) ma      **ag**      swan                      aman  
 who      **Comp**      drink.PERF.Part              water  
 ‘Who drank water?’
- (21) \*ma      swan                      aman  
 who      drink.PERF.Part              water  
 ‘Who drank water?’

In long-distance extraction, on the other hand, Comp is disallowed in the embedded clause as illustrated by (22) and (23). This, I argue, is a strong empirical evidence for C agreement or lack thereof. In other words, my proposal shows how C agreement is disallowed when T agreement (subject verb agreement) is allowed and how C agreement is allowed where T agreement is disallowed.

- (22) ma      ay      thenna              Fatima      iswa              aman  
 who      Comp      3sf.say.PERF      Fatima      3sm.drink.PERF      water  
 ‘Who did Fatima say drank water?’
- (23) \*ma      ay      thenna      Fatima      **ay**      iswa              aman  
 Who Comp      3sf.say.PERF      Fatima      Comp      3sm.drink.PERF      water  
 ‘Who did Fatima say drank water?’

An even stronger prediction is that in long distance extraction contexts and given the proposal that matrix C transfers its  $\Phi$ -features to T and keeps a copy,

we expect to see both “T-agreement” and “C-agreement” when this happens in the matrix domain. This prediction is born out as we see in (24):

- (24)    ma **ay**    **thenna**           Fatima iswa    aman  
           who **Comp** **3sf.say.PERF** Fatima 3sm.drink.PERF water  
           ‘Who did Fatima say drank water?’

If we drop “T-agreement” we get an ungrammatical sentence as we see in (25).

- (25)    \*ma    ag       **nan**       Fatima           iswa    aman  
           who    Comp say.PERF.Part    Fatima 3sm.drink.PERF    water  
           ‘Who did Fatima say drank water?’

Also, if we drop “C-agreement” we get, again, an ungrammatical sentence as in (26):

- (26)    \*ma       thenna           Fatima    iswa    aman  
           who       3sf.say.PERF    Fatima    3sm.drink.PERF water  
           ‘Who did Fatima say drank water?’

Similarly, we expect to see both T-Agreement and C-Agreement in Object extraction contexts in Berber, since T will agree with the subject and C will agree with, for example, a wh-object. In other words we expect feature sharing to be the only convergent option and to observe both subject-verb agreement and an obligatory Comp. These predictions are born out as shown in (27), (28), and (29).

- (27)    mani lekthab       \*(ay)    **theqra**                   therbat  
           which book       \*(Comp)           **3sf.read.PERF**    girl  
           ‘Which book did the girl read?’
- (28)    lekthab-a       \*(ay)           **theqra**                   therbat  
           book-this       \*(Comp)           **3sf.read.PERF**           girl  
           ‘It was this book that the girl read’
- (29)    lekthab           \*(ay)    **theqra** therbat ur-ighuda  
           book-this       \*(Comp) **3sf.read.PERF** girl       Neg-1sm.good  
           ‘The book that the girl read is not good’

The example in (27) is an object wh-question, (28) is an object cleft-construction and (29) is an object relative clause. As shown in all these cases, Comp or C-Agreement is obligatory as expected if we consider the derivation of (27) represented in (30) below.

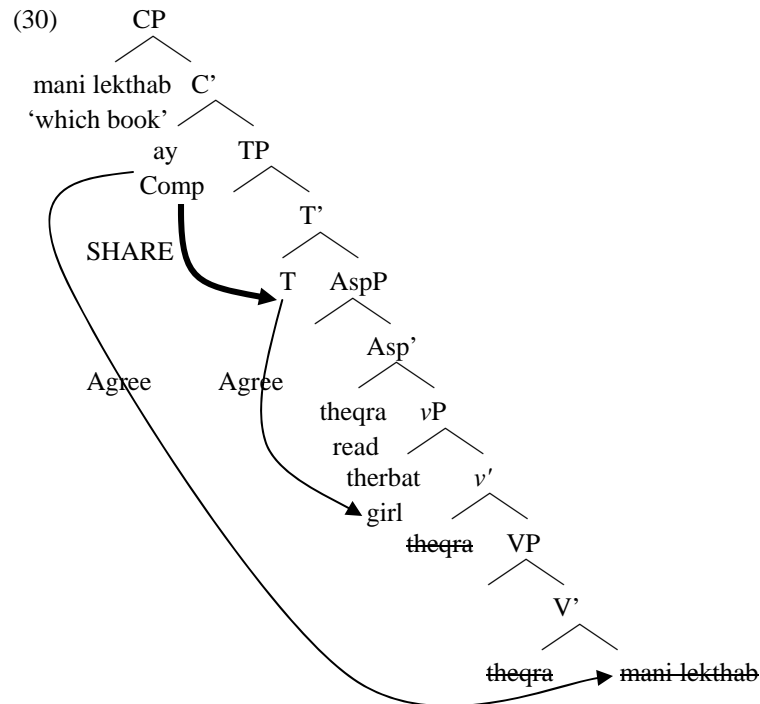

As shown in (30), we have a case of feature sharing, i.e. T inherits C's  $\Phi$ -features but C keeps a copy. Before we detail the analysis let us ask the question of what happens if T inherits  $\Phi$ -features without C keeping a copy (option 1). C will transfer its  $\Phi$ -features to T, and C will cease to be active. T will probe the subject and T-Agreement will be achieved, yet the [-valued] [-interpretable] wh-feature on the object will not be valued and deleted and the derivation will ultimately crash. What if on the other hand C keeps its  $\Phi$ -features (and doesn't share them). C will not transfer its  $\Phi$ -features to T, which means it will remain active and probe the closest active DP. The subject in Spec- $\nu$ P is the closest goal to C, and since C is  $\Phi$ -complete it will agree with the subject and value its case; the  $\Phi$ -features on C should conversely get valued and deleted. The same problem arises again here and that is the wh-feature on the wh-object will fail to get valued and deleted and the derivation will yet again crash. With the third option, i.e. feature sharing, the derivation proceeds as follows: C transfers its  $\Phi$ -features to T and keeps a copy. C and T are both active; T probes the closest goal i.e. the subject, and as a result T-Agreement is obtained as marked by the subject-verb agreement, and C probes the closest active DP which is now the wh-object, since the subject has been inactivated by T. C-Agreement is then

obtained as marked by the obligatory Comp. This is another compelling evidence for the different  $\Phi$ -Transfer options available.

## Conclusion

In this paper I showed that Anti-agreement is a case of C-agreement. I showed that feature inheritance, proposed by Chomsky (2004, 2006), and following Ouali (2006) (for Berber), is the mechanism at play in deriving agreement. I proposed that there are three options available given the hypothesis that C is the locus of  $\Phi$ -features. The first option is that T inherits C's  $\Phi$ -features and I showed that this is the case in simple declarative sentences. This option however can't derive "A-bar" constructions where we observe AAE (Ouhalla 1993, 2005), I proposed that in such cases C keeps its  $\Phi$ -features hence is an Agreeing C. Besides these two options, there is also a third option that derives argument long-distance extraction. In the latter cases C shares its  $\Phi$ -features with T; therefore, we get both T-agreement and C-agreement.

---

## Notes

\* I would like to thank Sam Epstein, Acrisio Pires, Daniel Seely and Jamal Ouhalla for their input on the analysis. Needless to say that I bear sole responsibility for any errors.

<sup>1</sup> Chomsky (2006) argues that tense feature is also inherited from C. In Ouali (in progress) I argue that this assumption is problematic in a derivational approach. If C is the locus of both phi-features and tense, then what is the nature of T? what is its status in the lexicon?

<sup>2</sup> By suppressed I mean T never received the phi-features from C, forcing default agreement morphology to appear on the verb (AAE).

## References

- Belletti, A. 2001. Agreement projections. In Baltin, M., and C. Collins (eds.), *The handbook of contemporary syntactic theory*. Oxford: Blackwell.
- Boskovic, Zeljko. 2002. A-movement and the EPP. *Syntax* 5: 167–218.
- Chomsky, Noam. 1991. Some notes on economy of derivation and representation. In R. Freidin, ed., *Principles and parameters in comparative grammar*, Cambridge, Mass: MIT Press.
- Chomsky, Noam. 1995. *The Minimalist program*. Cambridge, Mass: The MIT Press.
- Chomsky, N. 2000. Minimalist inquiries: the framework. In R. Martin, D. Michaels, and J. Uriagereka, eds. *Step by Step: Essays on Minimalist Syntax in Honor of Howard Lasnik*. Cambridge, MA: MIT Press.
- Chomsky, N. 2001. Derivation by phase. In Kenstowicz, ed. *Ken Hale: A Life*

- inLanguage*, MIT Press.
- Chomsky, Noam. 2004. Beyond explanatory adequacy. In *The cartography of syntactic structures. Vol.3, Structures and beyond*, ed. by Adriana Belletti. Oxford: Oxford University Press.
- Chomsky, Noam. 2005. Three Factors In Language Design. *Linguistic Inquiry*, 36-1, pp.1–22, MIT Press.
- Chomsky, N. 2005. On Phases. Ms., MIT.
- Chomsky, Noam. 2006. UG from below. ms. MIT.
- Epstein, S. D. and T. D. Seely, eds. 2002. *Derivation and explanation in the Minimalist Program*. Oxford: Blackwell.
- Epstein, S. D., A. Pires and T. D. Seely. 2005. EPP in T: More Cotroversial Subjects. *Syntax* 8:1, 65-80. Blackwell Publishing.
- Frampton, J., & Guttman, S. 1999. Cyclic Computation, a Computationally Efficient Minimalist Syntax. *Syntax*, 2, 1-27.
- Hiraiwa, K. 2001. Multiple agree and the defect intervention constraint. In *The proceedings of the HUMIT2000*, ed. O. Matushansky and E. Gurzoni, MIT Working Papers in Linguistics 40, 67-80. Cambridge, MA: MITWPL.
- Hiraiwa, K. 2005. Dimensions of Symmetry in Syntax: Agreement and Clausal Architecture. Ph.D. dissertation, MIT.
- Ouali, Hamid. 2005. Negation and negative polarity items in Berber. In Marc Ettliger, Nicholas Fleisher, and Mischa Park-Doob (eds.), *Proceedings of the Thirtieth Annual Meeting of the Berkeley Linguistics Society*, pp. 330-340. Berkeley: Berkeley Linguistics Society.
- Ouali, Hamid and Acrisio Pires. To appear. Complex Tenses, Agreement, and Wh -extraction. *Berkeley Linguistics Society Proceedings*. Berkeley, California.
- Ouali, Hamid. 2006. *Unifying Agreement Relations: A Minimalist Analysis of Berber*. Doctoral dissertation, University of Michigan.
- Ouhalla, Jamal. 1988b. *The Syntax of Head Movement: a study of Berber*. Doctoral dissertation, University of College London.
- Ouhalla, Jamal 1993. Subject-Extraction, Negation and the Anti-Agreement Effect. *Natural Language and Linguistic Theory*, 11, pp. 477-518. Dordrecht, Netherlands.
- Ouhalla, Jamal 2005b. Agreement features, Agreement and Antiagreement. *Natural Language and Linguistic Theory*. Dordrecht, Netherlands.
- Richards, Norvin. 2001. *Movement in language: Interactions and architectures*. Oxford: Oxford University Press.

Hamid Ouali  
 University of Wisconsin-Milwaukee  
 Department of Foreign Languages and Linguistics  
 University of Wisconsin-Milwaukee  
 883 Curtin Hall  
 3243 N. Downer Avenue  
 Milwaukee, WI 53211  
 Ouali@uwm.edu



# Phonological Phrasing in Barcelona Spanish

**Rajiv Rao**

University of California, Davis

## 1. Introduction

### 1.1 Prosodic phonology

Prosody in general is used to divide information into ‘chunks’ demonstrating definite size and internal structure (D’Imperio et al. 2005). Prosodic Phonology (Selkirk 1984, 1986; Nespor and Vogel 1986), which considers the relationship between syntax and prosody, hierarchically organizes prosodic constituents in the fashion shown in (1).

- (1) Prosodic Hierarchy<sup>1</sup>
- |          |                                    |
|----------|------------------------------------|
| IP       | Intonational Phrase (Major Phrase) |
| PPH      | Phonological Phrase (Minor Phrase) |
| PW       | Prosodic Word                      |
| F        | Foot                               |
| $\sigma$ | Syllable                           |

The various levels in (1) are defined in detail by Selkirk (1984), with the top three being the most pertinent to the present study. An IP is a unit that corresponds to a portion of a sentence associated with a characteristic intonational contour or melody. A PPH denotes any level of prosodic constituent structure that may include one or more major category words (i.e. lexical categories of Noun, Verb, Adjective, and Adverb, from Chomsky 1965). According to Truckenbrodt (1999, in press), the PPH and IP differ in that the former refers specifically to syntactic phrases (XPs), such as Noun Phrases (NPs), Verb Phrases (VPs), and Adjective Phrases (APs), while the latter deals with larger syntactic clauses. Furthermore, a PW is a phonologically relevant idea that plays a metrical role in describing main word stress.<sup>2</sup> In studies on Spanish intonation, it was noted as far back as Navarro Tomás (1944) that words are considered prosodically accented if they display a fundamental frequency (F0) rise through the stressed syllable. Those such as Quilis (1993) and Face (2003) note that such F0 rises are actually the strongest cues to stress in Spanish.

Therefore, in order to consider a lexical item a PW, it must contain a F0 rise through the stressed syllable.<sup>3</sup>

Phonological rules are applied to the prosodic constituents of the hierarchy. Previously, those such as Nespor and Vogel (1986) claimed that syntactic structure is that which dominates the distribution and division of prosodic constituents. This idea especially pertains to the top two levels of the hierarchy, the IP and PPH. Although it was mentioned in such older studies that speech rate, style, and emotion can lead to restructuring of IPs into shorter IPs, D'Imperio et al. (2005) emphasize that more recent studies (Steedman 1991; Ghini 1993; Truckenbrodt 1995, 1999; Ladd 1996; Selkirk 2000; among others) have shown that prosodic boundary placement in different languages is determined by factors other than merely syntax, namely constituent weight, symmetrical distribution of constituents, and information structure.

## 1.2 Phrasing in Spanish

The majority of studies on phonological phrasing decisions in Spanish and in Romance in general have been carried out in recent years.<sup>4</sup> The main experimental findings of those such as Elordieta et al. (2003), D'Imperio et al. (2005) and Frota et al. (in press) reveal and compare common phrasing patterns in Subject-Verb-Object (SVO) utterances across Romance. These studies, focusing mostly on Peninsular varieties of Spanish, find that (S)(VO) groupings tend to be most common. Cues to PPH boundaries are explored as well. In Spanish, high (H) boundary tones usually serve as markers of PPH boundaries. Furthermore, the F0 stretch before the boundary tends to appear as a *continuation rise*, which is a rise on the stressed syllable in nuclear position, which extends to the boundary syllable, or as a rise followed by *sustained pitch*, or a plateau up to the boundary syllable. Other cues, such as F0 reset and preboundary lengthening of a word or stressed syllable are shown to be used in Spanish as well.

There are few studies bridging OT and phrasing in Spanish. Prieto (2006) considers the rankings of a series of size and eurhythmic OT constraints that interact to explain the phonological phrasing of Peninsular Spanish declaratives in slow, normal, and rapid speech. The phrasing data given in the study, coming from recordings of sentences with various degrees of syntactic complexity, supports that well-formedness constraints dealing with the length and balance of PPHs within IPs have a crucial role in phrasing decisions. In fact, some of these well-formedness constraints rank higher than those addressing syntactic alignment and cohesion. Overall, the study suggests that a complete theory of prosodic phrasing must realize that prosody, syntax, and linguistic variation all interact in determining phrasing decisions.

Another study uniting phonological phrasing and OT in Spanish is Rao (2006). Inspired by Prieto's (2006) use of syntactic branching in Peninsular Spanish, this

investigation analyzes experimental data of phonological phrasing in rapid speech in the Spanish of Lima, Perú. Employing many of the prosodic and syntactic alignment constraints used by Prieto (2006) leads to a different constraint ranking, which reveals that satisfying prosodic well-formedness with regard to length and balance of PPHs is a much higher priority than is complying with the similar alignment of prosodic and syntactic boundaries (to an even greater degree than in Prieto's study). The phrasing differences between this study and that of Prieto motivate the introduction of a prosodic constraint prohibiting a rightward increase in length of PPHs within a given IP.

The present study expands on the work of Prieto (2006) and Rao (2006) by seeking to explain phonological phrasing in the dialect of Barcelona, Spain, using OT. It presents the phrasing decisions found in recordings of SVO sentences containing different degrees of syntactic branching of the subject NP and the direct object NP belonging to a higher VP. A constraint hierarchy emerges that fully accounts for the observed phrasing patterns with reference to solely prosodic constraints. The ranking proves that adopting modified versions of Ghini's (1993) prosodic principles for Italian into OT allows for a thorough explanation of the data without reference to syntactic constraints.

The remainder of the paper is organized as follows: Section 2 describes the methods used for data elicitation; Section 3 presents the frequencies of phrasing patterns and theoretically explains these results using OT; and Section 4 provides concluding remarks.

## 2. Methods

Inspired by the methodology of Prieto (2006), the 18 participants in the present study each read 65 sentences at a normal speech rate. This rate is what they consider to be appropriate, for example, when reading a text aloud to a friend. The 65 sentences consist of 13 sets of five sentences each. Each set contains sentences with simple SVO utterances or those with various degrees of syntactic branching on the subject NP or the direct object NP. Branching is achieved through APs or prepositional phrases (PPs). Unfortunately, due to recording difficulties, there are fewer tokens of subject NP branching, and thus fewer cases of this type of sentence will be included in the present OT analysis. Although sentences were created in groups according to structural similarities, they were randomized when presented to the participants. Four of the sets are constructed of simple SVO utterances, three sets show branching of the subject NP, and six sets demonstrate branching of the direct object NP. An additional factor considered is whether stressability of the determiner (meaning an additional PW) in the direct object NP affects the parsing of phrases in simple SVO utterances and those with direct object NP branching. Quilis (1993) served as an invaluable resource in distinguishing those determiners that are stressable from those that are not. Each determiner is equally divided among the sets of simple

SVO utterances and those with direct object NP branching. Examples of utterances with direct object branching are shown in (2).

(2) Branching of the direct object NP

- a. *Javier escribió una/muchas carta(s)*  
'Javier wrote a/many letter(s)'
- b. *Javier escribió una/muchas carta(s) larga(s)*  
'Javier wrote a/many long letter(s)'
- c. *Javier escribió una/muchas carta(s) larga(s) a sus amigos*  
'Javier wrote a/many long letter(s) to his friends'
- d. *Javier escribió una/muchas carta(s) larga(s) a sus amigos griegos*  
'Javier wrote a/many long letter(s) to his Greek friends'
- e. *Javier escribió una/muchas carta(s) larga(s) a sus amigos griegos de Atenas*  
'Javier wrote a/many long letter(s) to his Greek friends from Athens'

With respect to the speakers involved, due to the fact that Barcelona is a city in which Spanish and Catalan are in constant contact, it was important to carefully select participants for the study. Since the focus is on the dialect of Spanish spoken in this region, only speakers who are dominant in Spanish or who consider themselves as very balanced bilinguals were eligible to participate. A language history questionnaire helped screen for speakers who fit this requirement. Participants carried out the reading task in a phonetics laboratory at the *Universitat Autònoma de Barcelona*. They were recorded using the PitchWorks software package, a microphone, and a laptop computer.

The data analysis first involved confirmation that all stressable words are indeed accented and thus considered PWs. This is the case, as would be expected according to Face's (2003) description of lab speech in which he states that deaccenting is rare in this speech style. The phonetic cues documented in previous studies served as indicators of PPH boundaries. The most common cues observed in the present data are continuation rises, large decreases in pitch range, pre-boundary lengthening of the stressed syllable, and pauses. Figures 1 and 2 show examples of phrase boundaries. The vertical lines in each figure show where boundaries occur and the symbol 'ϕ' is used to indicate these boundaries in written form.

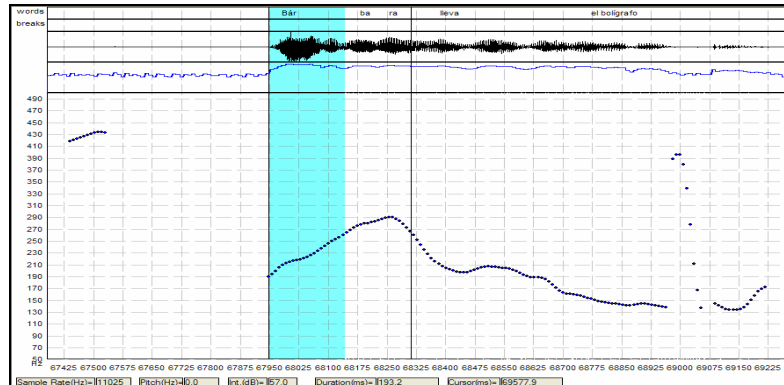

Figure 1: The phrasing of the simple SVO sentence *Bárbara lleva el bolígrafo* ('Barbara carries the pen'). The phrasing pattern observed is (Bárbara) $\phi$ (lleva el bolígrafo) $\phi$ . The highlighted portion represents the duration of the stressed syllable *Bar.*, of the subject *Bárbara*.

In Figure 1, there is a continuation rise ending on the final syllable of *Bárbara*, followed by a large decrease in pitch range, both of which are indicators of a PPH boundary. The F0 measurement of the first peak realized in the first PPH on *Bárbara* is 292.2 Hertz (Hz), while the second peak drops to 209.5 Hz. Although the trend of *downstepping* (i.e. peak decay) is often seen within PPHs in Spanish declaratives, Prieto et al. (1995, 1996), Face (2001, 2003) and Hualde (2003), among others, have described this pattern as a gradual decrease in F0 peak height rather than the drastic decrease seen here. Further evidence of a phrase boundary after the subject of the utterance in Figure 1 is that the stressed syllable, *Bar.*, is noticeably longer here than it is in a case in which the word *Bárbara* is not directly followed by a phrase boundary. In this example, the duration of the stressed syllable is 193.2 milliseconds (ms), which is much longer than the 138.3 ms duration of this same syllable found in the sentence *La Bárbara rubia lleva el bolígrafo* ('The blond Barbara carries the pen'), in which the phrase boundary is located after the AP *rubia*. This contrast is seen when comparing Figures 1 and 2.

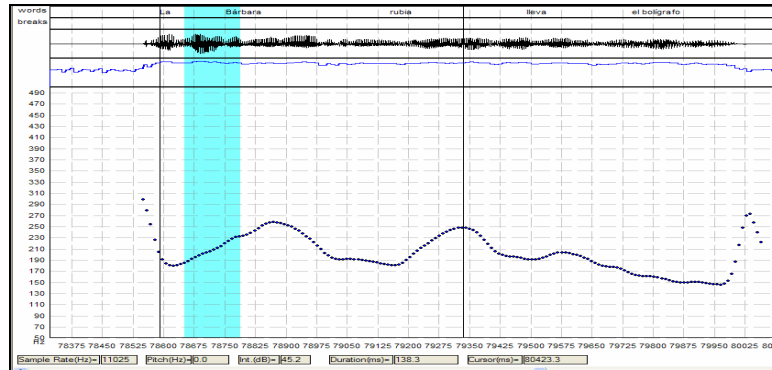

Figure 2: The phrasing of the sentence *La Bárbara rubia lleva el bolígrafo* ('The blond Barbara carries the pen'). The phrasing pattern observed is (La Bárbara rubia) $\phi$ (lleva el bolígrafo) $\phi$ .

In addition to the shorter duration of the stressed syllable of the word *Bárbara* in comparison to Figure 1, Figure 2 presents further evidence of a phrase boundary occurring after *rubia*. The first two peaks are manifested in a similar pitch range, with the first peak being at 260 Hz and the second at 250.4 Hz. The second peak, associated with the word *rubia*, is followed by an increased drop in F0 to 205.7 Hz, which is the height of the third peak, associated with the word *lleva*. The gradual decrease in F0 peak height between the first two peaks, which are within the same PPH, is expected due to downstep, however, the exaggerated drop to a much lower pitch range after the F0 rise to the second peak is indicative of a PPH boundary. The stressed syllable, *ru.*, of the word *rubia* is 188.7 ms in length, which is a longer observed duration compared to other sentences in the data in which this word is not before a PPH boundary.

### 3. Phrasing Results and OT Analysis

This section presents a series of OT tableaux that evaluate phonological phrasing patterns produced by speakers. Within each tableau, the pattern that is recorded at the highest frequency is considered optimal. Any other candidate with a frequency within 15% of the most frequent attains co-optimal status. This cut-off point was determined by charting the observed frequencies for all patterns produced in all utterances. When the top two or three patterns are within 15% of the most frequent, they clearly distinguished themselves from the remaining patterns, and therefore are deemed as co-optimal. Only phrasing patterns produced by speakers at a reasonable rate (about 10% or more) are included in the tableaux. It is assumed that all other possibilities are discarded by high ranking constraints that may not be mentioned in this analysis. Finally, of the sentences with branching of the direct object NP, only those with

stressable determiners are presented here due to limitations on space. It should be noted that the constraint ranking proposed is capable of explaining the phrasing trends observed in recordings of utterances that are not included.

When describing phrasing candidates, *prosodic weight* of PPHs is used synonymously with *length* of PPHs. Prosodic conditions such as weight balance and symmetry of PPHs increase *eurhythmicity*, which is the creation of regular, balanced stress periods (Prieto 2006).

The list of relevant constraints is provided in (3). The formal use of Ghini's (1993) principles was not applied to previous studies on Spanish phrasing, all of which contain utterances with less syntactic branching than those in the present study. The adaptation of these principles presented here heavily relies on the distribution of PWs in adjacent PPHs. This idea of adjacency is not explicitly stressed in Ghini's proposal. Therefore, the use of constraints (3a), (3b), and (3c) represents an innovative approach to phonological phrasing in OT, and, as will be seen, appears to allow for a more thorough explanation of sentences with more extensive syntactic branching. In sum, one of the main purposes of this OT analysis is to motivate the use of a larger set of prosodic constraints in accounting for phrasing data coming from a broad range of syntactically complex utterances. The absence of syntactic constraints is noteworthy, since such constraints are found to influence phrasing, at least to some degree, in most previous work on this topic.

(3) Relevant Prosodic and Syntactic Constraints<sup>5</sup>

a. WEIGHT BALANCE (WB) (adapted from Ghini 1993)

Given a phonological phrase, PPH, the number of PWs in PPH+1 or PPH-1 must be equal to the number of PWs in PPH. Within an IP, PPHs within each substring of three must have the same number of PWs (all PPHs dominated by the same IP node).

b. SYMMETRY (SYMM) (adapted from Ghini 1993)

i. Odd number of PPHs in an IP: Given a pivot, P, which is a medial PPH, the number of PWs in P+1, +2, ..., +n must be equal to the number of PWs in P-1, -2, ..., -n (all PPHs dominated by the same IP node).

ii. Even number of PPHs in an IP: Given a pivot P, which is a point between the two medial PPHs, the number of PWs in P+1, +2, ..., +n must be equal to the number of PWs in P-1, -2, ..., -n (all PPHs dominated by the same IP node).

c. INCREASING UNITS (IU) (adapted from Ghini 1993)

Given a phonological phrase, PPH, the number of PWs in PPH+1 must be greater than the total PWs in PPH (all PPHs dominated by the same IP node).

d. MIN-BIN (Prieto 2006, based on McCarthy and Prince 1993, Ghini 1993)

PPHs should consist of minimally two PWs.

The constraint ranking accounting for the experimental results is given in (4).

- (4) Hierarchy of constraints  
WB, IU >> MIN-BIN, SYMM

This arrangement of constraints variably ranks WB and IU and assumes that they are superior to MIN-BIN and SYMM in determining phrasing decisions. When the top two constraints are unable to decide between candidates, the task is passed down to the inferior strata, which is capable of choosing candidates that correspond with high frequencies.

### 3.1 Simple SVO utterances

Table 1 contains phrasing candidates produced for simple SVO utterances with an unstressable determiner in the direct object NP. Such utterances have three total PWs.

Javier dona el libro	WB	IU	MIN-BIN	SYMM
a. $\varnothing$ (Javier) $\phi$ (dona el libro) $\phi$	*		*	*
b. (Javier dona) $\phi$ (el libro) $\phi$	*	*!	*	*

Table 1: Phrasing candidates for *Javier dona el libro* ('Javier donates the book')  $\rightarrow$  (1 PW)  
 $\phi$ (2 PW) $\phi$  a) 75% b) 17%

In Table 1, the dashed lines between the top pair and the second pair of constraints signal variable rankings. These variable rankings increase flexibility in evaluating candidates and the interaction of constraints ranked in such a fashion is crucial in cases of co-optimality. In terms of electing a winner, candidate (a) is optimal because it does not violate IU, since the first PPH contains one PW and the second houses two PWs. This winner corresponds with the overwhelmingly most frequent pattern produced. IU fatally punishes (b) for decreasing units from right to left, since the first PPH has two PWs and the second has one PW. WB is highest ranked in this tableau, but the one violation for each candidate fails to distinguish between the two. Due to the fact that IU is decisive, the evaluation does not need to continue to the next level of constraints, MIN-BIN and SYMM.

Table 2 presents phrasing patterns from SVO utterances with four PWs. The extra PW is gained by adding a stressable determiner to the direct object NP.



Javier dona muchos libros	WB	IU	MIN- BIN	SYMM
a. (Javier) $\phi$ (dona muchos libros) $\phi$	*!		*	*
b. $\mathcal{E}$ (Javier dona) $\phi$ (muchos libros) $\phi$		*		
c. (Javier) $\phi$ (dona) $\phi$ (muchos libros) $\phi$	*!	*	**	*

Table 2: Phrasing candidates for *Javier dona muchos libros* ('Javier donates many books')  
 $\rightarrow$  (2 PW) $\phi$ (2 PW) $\phi$     a) 36%    b) 37%    c) 15%

Candidates (a) and (c) are quickly eliminated in Table 2 because they fatally violate WB. In (a) this is the case because there is an unequal amount of PWs in the first PPH and the second PPH. Although (c) balances its first two PPHs, the second and third PPHs are unbalanced. There is only one violation in (c) because only adjacent pairs of PPHs are sensitive to WB (and IU), and therefore, the imbalance between the first and third PPHs is not a violation. Candidate (b) satisfies the highest ranked constraint by equally distributing the four PWs across two PPHs. By maintaining WB, (b) incurs a violation of IU, since there is no increase in PWs in the right member of the adjacent pair of PPHs. However, IU is lower ranked here and cannot affect the optimal status of (b). This is the desired outcome based on the percentage value of (b). This winning candidate is actually the best across the board, seeing how it only has one total violation. By maintaining two PWs per PPH, it is balanced, symmetrical, and does not have any PPHs containing only one PW.

Reordering the top strata of variably ranked constraints in Table 2 yields the correct second optimal candidate, (a). Candidates (b) and (c) both fatally violate IU because they each contain adjacent pairs of PPHs that are balanced, and thus do not increase the number of PWs per PPH in the right member of the pair. This idea suggests that WB and IU have a somewhat antagonistic relationship. Therefore, a variable ranking of the two is strategically advantageous because in many cases it allows the ability to explain co-optimality of phrasing candidates demonstrating distinct patterns that favor different prosodic conditions. Candidate (a) does increase the number of PWs in the right member of the PPH pair, and therefore complies with IU. There is an increase of two PWs, which is perfectly satisfactory because there is no specification of how much of an increase needs to occur.

### 3.2 A case of syntactic branching of the subject NP

In Table 3, branching of the subject NP is done through the addition of an adjective. By adding this adjective, a simple SVO utterance of three PWs is stretched to total four PWs. The most frequently observed phrasing pattern is shown by candidate (a), which is perfectly balanced and parsed in groups of two

PWs. The ranking of constraints accounts for why this phrasing is observed at such an overwhelmingly high percentage value.

La Bárbara rubia lleva el bolígrafo	WB	IU	MIN-BIN	SYMM
a. $\mathcal{F}$ (La Bárbara rubia) $\phi$ (lleva el bolígrafo) $\phi$		*		
b.(La Bárbara) $\phi$ (rubia) $\phi$ (lleva el bolígrafo)	*!	*	**	*

Table 3: Phrasing candidates for *La Bárbara rubia lleva el bolígrafo* ('The blond Barbara carries the pen')  $\rightarrow$  (2 PW) $\phi$ (2 PW) $\phi$  a) 82% b) 10%

Upon first glance at the constraints ranked in the upper strata, it becomes apparent that candidate (b) has no chance at optimality because it violates both WB and IU. The violation of WB is fatal. Both sets of adjacent PPHs create problems for WB and IU in (b). The first and second PPHs fail to show a rightward increase in length, while the second and third PPHs fail to prosodically balance themselves. On the other hand, (a) only violates IU, due to its stronger commitment to weight balance. Even if the top two variably ranked constraints were reversed, candidate (a) would still be optimal because IU cannot distinguish between the two candidates, and the decision would be passed down to WB. Comparing the two candidates suggests that fewer PPHs are better, since more PPHs lead to more potential violations of constraints such as WB and IU that evaluate adjacent pairs.

### 3.3 Syntactic branching of direct object NPs with stressable determiners

When syntactic branching of the direct object NP is considered, sentences such as that in Table 4 are formed. The addition of an adjective to the direct object NP, results in a sentence with five total PWs.

Carmen habló varios dialectos nuevos	WB	IU	MIN-BIN	SYMM
a. $\mathcal{F}$ (Carmen habló) $\phi$ (varios dialectos nuevos) $\phi$	*			*
b. (Carmen) $\phi$ (habló varios dialectos) $\phi$ (nuevos) $\phi$	**!	*	**	
c. (Carmen) $\phi$ (habló varios dialectos nuevos) $\phi$	*		*!	*
d. (Carmen) $\phi$ (habló) $\phi$ (varios dialectos nuevos) $\phi$	*	*!	**	*

Table 4: Phrasing candidates for *Carmen habló varios dialectos nuevos* ('Carmen spoke various new dialects')  $\rightarrow$  (2 PW) $\phi$ (3 PW) $\phi$  a) 36% b) 17% c) 12% d) 11%

The frequency values of candidates in Table 4 indicate that (a) should be the optimal candidate. By ranking WB atop the hierarchy of constraints, (b) is discarded because it contains two adjacent pairs of PPHs that are not balanced for prosodic weight. When comparing (b) to (a) and (c), we realize that (b) has one more PPH than (a) and (c), and that due to this trait, it is susceptible to more violations of WB and IU because it has more pairs of adjacent PPHs. Since (a), (c) and (d) are tied with one violation each of WB, they are next judged on compliance with IU. Candidate (d) is filtered out of the competition because its first two PPHs do not show an increase in PPH length. After evaluation of candidates using the top two constraints, (a) and (c) remained tied. This is the first case in which it is necessary to resort to the lower pair of variably ranked constraints to determine optimality. When considering MIN-BIN, (a) wins because it does not have any PPHs of less than two PWs in length, whereas the first PPH in (c) is one PW long, which leads to a fatal violation. Switching the order of ranking of MIN-BIN and SYMM would not affect the outcome because the latter constraint is violated the same number of times by both (a) and (c). Finally, reversing the ranking of WB and IU does not affect the outcome either. If this were done, (b) and (d) would immediately be eliminated and the remainder of the evaluation would lead to the same result of (a) being optimal.

With increased syntactic branching of the VP maximal projection to a sentence with six PWs, three patterns are produced frequently enough to be considered for evaluation. These three patterns are contained in Table 5.

Carmen habló varios dialectos nuevos con sus colegas	WB	IU	MIN-BIN	SYMM
a. $\phi$ (Carmen habló) $\phi$ (varios dialectos nuevos) $\phi$ (con sus colegas) $\phi$	**	*	*	*
b. (Carmen) $\phi$ (habló varios dialectos nuevos) $\phi$ (con sus colegas) $\phi$	**	*	**!	
c. (Carmen) $\phi$ (habló) $\phi$ (varios dialectos nuevos) $\phi$ (con sus colegas) $\phi$	**	**!	***	*

Table 5: Phrasing patterns produced of *Carmen habló varios dialectos nuevos con sus colegas* ('Carmen spoke various new dialects with her colleagues')  $\rightarrow$  (2 PW)  $\phi$  (3 PW)  $\phi$  (1 PW)  $\phi$  a) 47% b) 32% c) 10%

The candidates in Table 5 all violate the highest ranked constraint, WB, multiple times. This is because they each have two pairs of adjacent PPHs that do not contain equal numbers of PWs. The equal number of violations makes WB indecisive and passes the evaluation down to IU. Both (a) and (b) have one

violation of IU because of the decrease in PPH length from the second to the third PPH in each case. Candidate (c) fatally violates IU because the second PPH is not longer than the first and the fourth is not longer than the third. The fact that (c) has one more PPH than the other two candidates provides increased support for the low probability of candidates with more total PPHs of achieving optimal status. Upon moving down to MIN-BIN, the tie between (a) and (b) is broken by the second violation of this constraint by (b), whose first and last PPHs have just one PW. Only the final PPH of (a) violates this minimality constraint.

When MIN-BIN and SYMM are flipped in Table 5, (b) is the winning candidate, thus sharing co-optimal status with candidate (a). Ranking SYMM higher than MIN-BIN generates (b) as the winner because this candidate is symmetrical. The medial PPH has four PWs and the two flanking PPHs are balanced in that they have one PW each. With this ranking, this type of structure is preferred over one that demands the absence of PPHs that enclose individual PWs. The co-optimality of (a) and (b) is the desired outcome based on experimental findings, because (a) is the highest observed frequency and (b) is within the 15% of 47%.

The phrasing candidates of data from a sentence constructed by adding an additional adjective to the sentence from Table 5 are displayed in Table 6. This sentence has a total of seven PWs and two viable candidates.

Carmen habló varios dialectos nuevos con sus colegas españolas	WB	IU	MIN-BIN	SYMM
a. $\phi$ (Carmen habló) $\phi$ (varios dialectos nuevos) $\phi$ (con sus colegas españolas) $\phi$	**	*		
b. (Carmen) $\phi$ (habló varios dialectos nuevos) $\phi$ (con sus colegas españolas) $\phi$	**	*	*!	*

Table 6: Phrasing candidates for *Carmen habló varios dialectos nuevos con sus colegas españolas* ('Carmen spoke various new dialects with her Spanish colleagues')  $\rightarrow$  (2 PW) $\phi$  (3 PW) $\phi$ (2 PW) $\phi$  a) 48% b) 23%

In Table 6, WB and IU are unable to distinguish between the two candidates because each violates these constraints to the same extent. In both cases, WB is violated because both adjacent pairs of PPHs in each candidate are not equal in number of PWs. IU punishes (a) and (b) one time each for decreasing PPH length from the second to the third PPH. The tie resulting from the top two constraints forces the decision down to MIN-BIN and SYMM. In terms of these two constraints, they are able to break the tie because (b) violates each one once, while (a) respects the demands of both. The first PPH of (b) has one PW, which rejects the requirement of MIN-BIN. Candidate (b) also organizes itself asymmetrically, since the PPHs on either side of the medial PPH that has four

PWs are unequal in length. Candidate (a) is satisfactory because it does not have a PPH containing just one PW, and the two PPHs surrounding the medial one create a symmetrical structure. The constraint ranking yielding (a) as optimal correctly explains its high frequency.

As the same sentence from previous tables is further expanded to eight total PWs by adding another PP, the frequencies observed point to co-optimality. The reason behind the equality of these two phrasing patterns is explicated by the constraint interaction in Table 7.

Carmen habló varios dialectos nuevos con sus colegas españolas de la universidad	WB	IU	MIN-BIN	SYMM
a. ☞ (Carmen habló)ϕ(varios dialectos nuevos) ϕ(con sus colegas españolas)ϕ(de la universidad)ϕ	***	**	*	**
b. (Carmen)ϕ(habló varios dialectos nuevos)ϕ(con sus colegas españolas)ϕ(de la universidad)ϕ	***	**	**!	*

Table 7: Phrasing candidates for *Carmen habló varios dialectos nuevos con sus colegas españolas de la universidad* ('Carmen spoke various new dialects with her Spanish colleagues from the university') → (2 PW)ϕ(3 PW)ϕ(2 PW)ϕ(1 PW)ϕ  
 a) 39%      b) 24%

In Table 7, the highest ranked pair of constraints is unable to decide which candidate is more desirable. Both candidates (a) and (b) violate WB three times because none of the adjacent pairs of PPHs are balanced in either phrasing pattern. IU is also violated twice by both candidates. In both cases, there is a decrease in PPH length when shifting from the second to the third PPH, and also from the third to the final PPH. The decision on optimality now must be made by the lower ranked constraints. Candidate (b) disobeys MIN-BIN one more time than (a), and thus can be eliminated by this constraint. While both (a) and (b) are targeted by this constraint for their final PPHs, (b) is punished one extra time for its first PPH that individually phrases the subject, *Carmen*. The second violation by (b) is fatal, which gives (a) as optimal. This result helps explain why (a) occurs at the highest frequency. However, (b) records a frequency value within 15% of (a) and therefore merits co-optimal status.

The main structural difference between candidates (a) and (b) in Table 7 is found in the first two PPHs. The first pattern has PPHs of two and then three PWs while the second has PPHs of one and then four PWs. In this example where each candidate contains four PPHs, we are able to witness the importance of the formal definition of SYMM. In evaluating the symmetry of each candidate we must first locate the pivot, which is between the two medial PPHs, and then

evaluate pairs of PPHs that are equidistant (on the right or left) from the pivot. For example, in the pattern  $(1 \text{ PW})\phi(4 \text{ PW})\phi(2 \text{ PW})\phi(1 \text{ PW})\phi$ , represented by (b), the pairs of PPHs to be evaluated are the second and third (immediately to the left and the right of the pivot), and the first and fourth (both equidistant on the left and right from the pivot). Only the first of the aforementioned pairs is out of balance in (b), and thus we have one violation of SYMM by this candidate. In the  $(2 \text{ PW})\phi(3 \text{ PW})\phi(2 \text{ PW})\phi(1 \text{ PW})\phi$  pattern seen in (a), upon using the same baseline of judgment, it becomes apparent that there are two violations because the first and fourth PPHs are incongruent as are the second and third PPHs. Through the one less violation of this “mirror-image” type of constraint, (b) emerges as optimal over (a).

#### 4. Conclusion

To my knowledge, there have been no previous studies analyzing phrasing in OT using only prosodic well-formedness constraints. Early work in end-based approaches assumes that syntax is the main factor influencing phonological phrasing decisions. More recent work includes prosodic conditions, however, a certain amount of reliance on syntax has remained. In extending on this study, an interesting application of OT to phrasing would be using a Rank-Ordering model of EVAL (Silva 2004; Coetzee to appear), which would present an alternate approach to accounting for phonological variability instead of the percentage cut-off value. Overall, through the inspiration of those such as Selkirk (1984, 1986, 2000), Ghini (1993), Truckenbrodt (1995, 1999), and Prieto (2006), this study hopes to serve as an experimental and theoretical advancement in the study of phrasing by revealing the possibility of utilizing solely prosodic factors in explaining the distribution of PWs in PPHs in sentences with complex syntactic organization.

---

#### Notes

<sup>1</sup> Earlier work using this hierarchy, such as that of Nespov and Vogel (1986), also included a Clitic Group level between the PW and PPH. This level has been excluded from the hierarchy in more recent studies.

<sup>2</sup> According to Ladd (1996), *stress* concerns perceived prominence of lexical items in an utterance, where as *accent* refers specifically to intonational F0 movement, which serves as one possible phonetic cue to the location of perceived prominence.

<sup>3</sup> Quilis (1993) provides a very extensive and useful list of types of *palabras acentuadas e inacentuadas* (‘stressed and unstressed words’). The stressed words are those that are expected to be accented due to the presence of a F0 rise on the stressed syllable. Unstressed words are those in which such a rise is not normally anticipated. However, factors such as speech rate and emphasis can lead to the opposite trends.

<sup>4</sup> Other investigations of phrasing decisions in Romance include Garrido et al. (1995) for Spanish, Ghini (1993) for Italian, Frota (2000) for European Portuguese, Sandalo and Truckenbrodt (2003) for Brazilian Portuguese, and Prieto (2005) for Catalan.

---

<sup>5</sup> Constraints such as MAX-BIN (Sandaló and Truckenbrodt 2003, based on Nespó and Vogel 1986, Ghini 1993), MIN-BIN (IP) (adapted from Selkirk 2000), ALIGN-XP, R: ALIGN (XP, R;  $\phi$ , R) (Selkirk 1986, 2000), and WRAP-XP (Truckenbrodt 1995, 1999) have been used in previous work on phrasing in Spanish and other languages. These constraints are not found to play a crucial role in determining phrasing decisions for speakers of this dialect. When candidates containing just one PPH in an IP are present, they do not violate any constraints in (4), since the idea of adjacency is not applicable. Although such PPHs are rarely present in the data, one way of eliminating them in OT tableaux is highly ranking MIN-BIN (IP), which requires that IPs be minimally binary.

## References

- Chomsky, Noam. 1965. *Aspects of the Theory of Syntax*. Cambridge: The MIT Press.
- Coetzee, Andries. To appear. "Variation as accessing "non-optimal" candidates- a rank-ordering model of EVAL," *Phonology*.
- D'Imperio, Mariapaola, et al. 2005. "Intonational phrasing in Romance: The role of syntactic and prosodic structure," *Prosodies*, ed. by Sónia Frota, Marina Vigário and Maria João Freitas: 59-98. The Hague: Mouton de Gruyter.
- Elordieta, Gorka, et al. 2003. "Effects of constituent length and syntactic branching on intonational phrasing in Ibero-Romance," *Proceedings of the XVth International Congress of Phonetic Sciences*: 487-490.
- Face, Timothy. 2001. *Intonational Marking of Contrastive Focus in Madrid Spanish*. Columbus OH: The Ohio State University Doctoral Dissertation.
- Face, Timothy. 2003. "Intonation in Spanish declaratives: differences between lab speech and spontaneous speech," *Catalan Journal of Linguistics*, 2: 115-131.
- Frota, Sónia. 2000. *Prosody and Focus in European Portuguese: Phonological Phrasing and Intonation*. New York: Garland.
- Frota, Sónia, et al. In press. "The phonetics and phonology of intonational phrasing in Romance," *Laboratory Approaches to Romance Phonology*, ed. by Pilar Prieto, Joan Mascaró and Maria Josep Solé. Amsterdam/Philadelphia: John Benjamins.
- Garrido, Juan M., et al. 1995. "Prosodic markers at syntactic boundaries in Spanish," *Proceedings of the XIVth International Congress of Phonetic Sciences*: 370-373.
- Ghini, Mirco. 1993. *Phonological Phrase Formation in Italian*. Toronto, Ontario: University of Toronto Master's Thesis.
- Hualde, José Ignacio. 2003. "El modelo métrico y autosegmental," *Teorías de la entonación*, ed. by Pilar Prieto: 155-184. Barcelona: Ariel.
- Ladd, Robert. 1996. *Intonational Phonology*. Cambridge: Cambridge University Press.
- McCarthy, John and Prince, Alan. 1993. "Generalized alignment," *Yearbook of Speech Communication and Technology* ed. by G. Booij and J. Van Marle: 79-153. Dordrecht: Kluwer.
- Navarro Tomás, Tomás. 1944. *Manual de entonación española*. New York: Hispanic Institute in the United States.
- Nespó, Marina and Vogel, Irene. 1986. *Prosodic Phonology*. Dordrecht: Foris.
- Prieto, Pilar, et al. 1995. "The absence or presence of a declination effect on the descent of F0 peaks? Evidence from Mexican Spanish," *Grammatical Theory and Romance Languages*, ed. by Karen Zagona: 197-207. Philadelphia: John Benjamins.
- Prieto, Pilar, et al. 1996. "Pitch downtrend in Spanish," *Journal of Phonetics* 24: 445-473.

- 
- Prieto, Pilar. 2005. "Syntactic and eurhythmic constraints on phrasing decisions in Catalan," *Studia Lingüística*, **59**.2-3: 194-222.
- Prieto, Pilar. 2006. "Phonological phrasing in Spanish," *Optimality-Theoretic Advances in Spanish Phonology*, ed. by Sonia Colina and Fernando Martínez-Gil. Amsterdam/Philadelphia: John Benjamins.
- Quilis, Antonio. 1993. *Tratado de fonología y fonética españolas*. Madrid: Editorial Gredos.
- Rao, Rajiv. 2006. "On the phonological phrasing patterns in the Spanish of Lima, Perú." Manuscript submitted to the *Southwest Journal of Linguistics*.
- Sandalo, Filomena and Truckenbrodt, Hubert. 2003. "Some notes on phonological phrasing in Brazilian Portuguese," *D.E.L.T.A.*, **19**.1: 1-30.
- Selkirk, Elisabeth. 1984. *Phonology and Syntax: The Relation Between Sound and Structure*. Cambridge: The MIT Press.
- Selkirk, Elisabeth. 1986. "On derived domains in sentence phonology," *Phonology Yearbook*, **3**: 371-405.
- Selkirk, Elisabeth. 2000. "The interaction of constraints on prosodic phrasing. Prosody: theory and experiment," *Studies presented to Gosta Bruce*, ed. by M. Horne: 231-261. Dordrecht, Boston and London: Kluwer.
- Silva, David James. 2004. "Quantified optimality and the phonological parsing of Korean SOV sentences," *Korean Linguistics*, **12**: 25-54.
- Steedman, Mark. 1991. "Structure and intonation," *Language*, **67**: 260-296.
- Truckenbrodt, Hubert. 1995. *Phonological Phrases: Their Relation to Syntax, Prominence and Focus*. Boston: MIT Doctoral Dissertation.
- Truckenbrodt, Hubert. 1999. "On the relation between syntactic phrases and phonological phrases," *Linguistic Inquiry*, **30**: 219-255.
- Truckenbrodt, Hubert. In press. "The syntax-phonology interface," *The Cambridge Handbook of Phonology*, ed. by Paul de Lacy. Cambridge: Cambridge University Press.

Rajiv Rao  
 University of California, Davis  
 Department of Spanish & Classics, 1 Shields Ave.  
 Davis, CA 95616  
 rgrao@ucdavis.edu



# Reflecting AGREE: Hindi-Urdu Reflexives<sup>1</sup>

**Richa**

Centre for Linguistics, Jawaharlal Nehru University, New Delhi,  
India-110067

## 1. Introduction

The long-distance binding properties of reflexives has long been acknowledged to pose difficulties for the standard binding theory (Chomsky 1981, 1986), whereby a reflexive must be bound<sup>2</sup> by a c-commanding<sup>3</sup> antecedent in a uniform structural context.

(1) Principle A: An anaphor is bound in its Governing Category<sup>4</sup>

The properties of monomorphemic reflexives in languages like Hindi-Urdu do not follow from the standard version of Principle A. Hindi-Urdu employs a monomorphemic X<sup>0</sup>-reflexive *apna* ‘self’ – that may also be used locally as a possessive reflexive- in addition to the morphologically more complex XP-reflexive, the ‘X-self’ reflexive *apne-aap*. The monomorphemic self-reflexive has quite distinct properties from those of the complex reflexive. First, monomorphemic reflexives may take quite long distance (subject) antecedents, whereas complex reflexives are typically local in nature. Second, complex reflexives, unlike these monomorphemic reflexives, exhibit a very strong ‘subject orientation.’

The following empirical facts about the binding of possessive reflexives are widely accepted. Firstly, as (2) shows, speakers uniformly disallow non-subject antecedents in simplex clauses:

(2) *ram<sub>i</sub>-ne si:ṭa<sub>j</sub>-ko əpni<sub>i/\*j</sub> kiṭab ḍi*  
 Ram-ERG Sita-DAT self’s book gave-pst  
 ‘Ram<sub>i</sub> gave Sita<sub>j</sub> self’s<sub>i/\*j</sub> book.’

Second, as (3) - (7) show, many speakers allow the matrix subject or the embedded subject to serve as the antecedent for the possessive reflexive in a non-finite clause<sup>5</sup>:

- (3) ram<sub>i</sub>-ne si:ʈa<sub>j</sub>-ko [PRO<sub>j</sub> əpni<sub>i/j</sub> bəʈai kəʈe hue suna]  
 Ram-ERG Sita-DAT self's praise do-IMPF be-PF hear-pst.  
 'Ram<sub>i</sub> heard Sita<sub>j</sub> doing self's<sub>i/j</sub> praise.'
- (4) nu.r<sub>i</sub>-ne əmina<sub>j</sub>-ko [PRO<sub>j</sub> əpne<sub>i/j</sub> kəmre mē bheʃ dʒiʃa]  
 Noor-ERG Amina-DAT self's room into send give-pst  
 'Noor<sub>i</sub> sent Amina<sub>j</sub> into self's<sub>i/j</sub> room.'
- (5) ram<sub>i</sub>-ne si:ʈa<sub>j</sub>-ko [PRO<sub>j</sub> əpne<sub>i/j</sub> ghər mē ghuʃte hue] dək<sup>h</sup>a  
 Ram-ERG Sita-DAT self's house into enter-IMPF be-PF see-pst  
 'Ram<sub>i</sub> saw Sita<sub>j</sub> entering into self's<sub>i/j</sub> house.'
- (6) ram<sub>i</sub>-ne si:ʈa<sub>j</sub>-ko [PRO<sub>j</sub> əpni<sub>i/j</sub> gaʈi lane-ko] kəha  
 Ram-ERG Sita-DAT self's car bring-to say-pst  
 'Ram<sub>i</sub> asked Sita<sub>j</sub> to bring self's<sub>i/j</sub> car.'
- (7) ram<sub>i</sub>-ne si:ʈa<sub>j</sub>-se [PRO<sub>i</sub> əpni<sub>i/\*j</sub> gaʈi lane-ka] vaɖaa kija  
 Ram-ERG Sita-ISTR. self's car bring-GEN promise do-pst  
 'Ram<sub>i</sub> promised Sita<sub>j</sub> to bring self's<sub>i/\*j</sub> car.'

In the examples above (3)-(7), the Standard Binding Theory would identify the binding domains of the reflexives as the IP that contains them, and Principle A would require that the reflexive be locally bound by a c-commanding antecedent in this local domain.

Reflexive raising approaches (Pica, 1987, 1991; Cole, Hermon & Sung, 1990; Cole & Sung, 1994) were suggested as a remedy – in such approaches, it is argued that reflexive interpretation is accomplished by raising the reflexive into the domain of its antecedent due to their lack of a full  $\phi$ -set. Different categorial status is taken to be responsible for the difference in the distribution of reflexives. Long-distance (LD) reflexives have the categorial status of X<sup>0</sup> categories that project a structure with the head (the reflexive) and its maximal projection. Local reflexives, on the other hand are XPs that lack any internal X-bar theoretical structure. So, long-distance binding of X<sup>0</sup>-reflexives are arrived at by its successive cyclic raising X<sup>0</sup>- movement at LF (satisfying Principle A at each step). XP-reflexives, on the other hand can not move successively cyclically, and may adjoin to its containing XP.

Such reflexive raising has however proven difficult to maintain in more recent times, given theoretical developments in the analysis of clause structure, and the move towards minimalist theorising. With the explosion of INFL yielding a profusion of potential landing sites for reflexive raising, it became unclear as to the head of which functional projection (AGR-sP, AGR-oP, TP) reflexive-raising would target. Alice Davison (1998) claims that in languages like Hindi-Urdu, the reflexive cliticizes to TENSE, not AGR. Movement is required for interpretation, for the non-finite clauses. Kidwai (2000) proposes that all languages raise X<sup>0</sup>-reflexives to Tns and Principle A can evaluate derivations only when the reflexive reaches Tns. Principle A may

be evaluated at two points in the derivation and hence, the ambiguity of reference of the reflexive.

In minimalism, the question becomes one of whether such LF raising was a legitimate operation in itself. Considering optimal design specifications, the minimalist program opts for the possibility of multiple spell-out, eliminating the post spell-out operations like LF raising. This option is a kind of language-architectural simplification, too, as it means just one cycle; all operations being cyclic. If both overt and covert operations are cyclic, then there has to be two independent cycles; and if operations of the phonological component are cyclic, a third cycle as well. With cyclic Spell-Out contingent on feature-checking operations, these operations collapse.

Furthermore, LF raising violates the No Tampering Condition (NTC), which requires that the features of lexical items should not be altered in the course of a derivation. However, the LF raising of features inevitably modifies within the respective lexical items, and is hence, undesirable.

These architectural as well as technical impediments paved the way for Move F to be replaced with AGREE in Chomsky (2000), making a re-evaluation of the claim that LF raising of reflexives is necessary. Recalling that the objective of such raising was necessitated as a mechanism of local SPEC-Head agreement, it is clear that if AGREE may suffice to effect such agreement, LF-raising need not be postulated. In this paper, I shall argue that the impoverished  $\varphi$ -set of a (possessive) reflexive is the crucial determinant of its referential dependence, and that the licensing of these (deficient)  $\varphi$ -sets under AGREE yields the local and LD binding properties of reflexives.

The paper is organised as follows: The next section 2 lays down the main theoretical proposal of this paper. Section 3 presents the analysis of reflexives licensing. Section 4 extends the analysis and exploits the notion of weak phase in order to elucidate the reflexive interpretation in various constructions in Hindi-Urdu. The final section 5 provides the conclusion.

## 2. Theoretical Proposal

As stated in *Minimalist Program* (1995), the core property of  $C_{HL}$  is 'feature checking' - the features of the head must be checked, or the derivation crashes. So, movement is forced to check feature and that too, is permitted if there were no other way. Note that with reflexives the case differs. In Reflexive Raising Approaches, reflexives move in order to acquire the full set of  $\varphi$ -features. After that, checking relations come into the picture. So, there has to be two kinds of movements for reflexives, one, to acquire  $\varphi$ -features and the other, to get the features checked. This seems somewhat incompatible. Furthermore, though the anaphoric nature of the reflexive is considered to be

due to a lack of a full  $\varphi$ -set in all the approaches, only some of them consider raising of the reflexives to be the entailment of this lack of a full  $\varphi$ -set.

Most of the minimalist approaches to reflexive interpretation make crucial use of the morphological impoverishment of reflexives. While one set of approaches (Pica 1987,1991; Cole, Hermon & Sung 1990) poses this in terms of categorial status, the other, particularly Richards (1996), adduces this to an impoverished  $\varphi$ -set. In my view, the former is simply incorrect and theoretically untenable, as under current assumptions of Bare Phrase Structure, a category that projects no further is both minimal and maximal. Furthermore, the XP-reflexives also show morphological impoverishment in terms of  $\varphi$ -features. Therefore, proper characterization of reflexives is that which attributes to them an impoverished  $\varphi$ -set, which must be licensed under Agreement.

Reuland (2001) proposes that simplex anaphors enter into “real dependency” with their antecedents within  $C_{HL}$  through a syntactically encoded CHAIN relation R. This relation obeys the Inclusiveness condition. Reuland defines it in terms of properties of movement and checking of features.

(8) Chain- ( $\alpha$ ,  $\beta$ ) form a Chain if (a)  $\beta$ 's features have been (deleted by and) recovered from  $\alpha$ , and (b) ( $\alpha$ ,  $\beta$ ) meets standard conditions on chains such as uniformity, c-command, and locality.

(9) If ( $\alpha_1$ ,  $\alpha_2$ ) is a Chain and ( $\beta_1$ ,  $\beta_2$ ) is a chain and  $\alpha_2 = \beta_1$ , then ( $\alpha_1$ ,  $\alpha_2$  /  $\beta_1$ ,  $\beta_2$ ) is a CHAIN. (Reuland 2001:457-58)

Thus, the CHAIN formation results from checking and Move/Attract. This is conceptually analogous to operation AGREE in MI (2000). In MI, checking reduces to deletion under matching with an active goal and then, deletion of the uninterpretable feature that render the goal active. Probe seeks a goal, ‘matching’ features that establish agreement.

(10) AGREE is an operation “which establishes a relation (agreement, case-checking) between an LI  $\alpha$  and a feature F in some restricted search space (its domain).” (Chomsky 2001: 14)

My proposal is that in the light of LF raising being obsolete, AGREE is the means of reflexive interpretation where the reflexive agrees with T in situ. Uninterpretable features of T enter into an agreement relation with interpretable features of reflexive, yielding the surface effect of agreement. Given the Inclusiveness condition, AGREE can be taken as the core operation in reflexive interpretation.

### 3. Licensing Reflexives

With an operation like Agree,  $\varphi$ -set licensing takes place in situ, movement only possible with an EPP-feature. I propose that reflexive interpretation

involves an Agree relation between T and the reflexive. Consider the following sentence in Hindi-Urdu,

11. (a) [TP ram-ne[<sub>VP</sub> mohən-ko əpni kiṭab ɖi]]  
 Ram-ERG Mohan-DAT self's book gave-pst

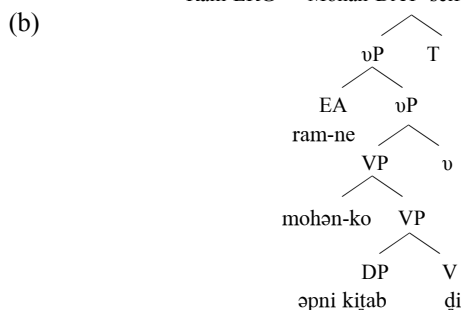

T has uninterpretable features of two kinds: the  $\phi$ -features and the selectional feature EPP. EPP seeks an XP to merge with the category it heads.  $\phi$ -set is a probe that seeks a goal, matching features to establish agreement. The  $\phi$ -set of T locates the reflexive as the goal. The reflexive agrees with T. This operation does not delete the  $\phi$ -set of T as the  $\phi$ -set of the reflexive is incomplete. Therefore, Agree holds between the probe T and the more remote goal *ram-ne* deleting its  $\phi$ -set and the structural case of *ram-ne*.

This analysis captures the subject antecedents for both possessive reflexives and otherwise. It also explains long-distance use of reflexives in Chinese. Consider the example,

12. zhangsan<sub>i</sub> renwei Lisi<sub>j</sub> zhidao wangwu<sub>k</sub> xihuan ziji<sub>i/j/k</sub>. (*Chinese*)  
 Zhangsan think Lisi know Wangwu like self  
 'Zhangsan<sub>i</sub> thinks Lisi<sub>j</sub> knows Wangwu<sub>k</sub> likes self<sub>i/j/k</sub>'

Here also, the T (whether embedded or matrix one) seeks reflexive as goal, but as its  $\phi$ -set remains intact, it has to agree with the subject of its own clause. Thus, the reflexive gets the subject antecedents' interpretation. Let us consider the 'blocking effect' in Chinese,

13. zhangsan renwei [wo zhidao [wangwu xihuan ziji]]  
 Zhangsan think I know Wangwu like self  
 'Zhangsan thinks that I know that Wangwu likes himself.'

Here, *ziji* can only be coindexed with *Wangwu*.

It can be argued that the Chinese reflexive *ziji* has a person feature in its  $\phi$ -set. So, it has to get valued. If it does not, the derivation crashes. That is why, we get 'blocking effect' in Chinese. In Hindi-Urdu, the person feature is not encoded in the  $\phi$ -set of the reflexive, only gender and number are. Consider the following paradigm,

14.	I p sg/pl	II p sg/pl	III p sg/pl
	əpni kiṭab	əpni kiṭab	əpni kiṭab
	self's book	self's book	self's book

So, only gender and number have to get value. Thus, unlike in Chinese, we do not encounter blocking effect in Hindi-Urdu.

#### 4. Extending the Analysis

The analysis so far does not explain the facts of reflexive interpretation in participials, non-finite nominalised clauses, verbal non-finite clauses and ECV constructions (light verb constructions) in Hindi-Urdu. I will exploit the notion of weak phase to explain these.

##### 4.1. Checking in weak phase

Before zeroing in on the main analysis, let us first consider Chomsky's analysis of participial passives and its relation to the notion of strong-weak phase.

15. (a) [C [  $\beta$  T seem  
[EXPL to have been [  $\alpha$  caught several fish]]]  
[  $\beta$  v expect

The probes (T or v) agree with EXPL and *fish*. T deletes the uninterpretable feature of EXPL; v deletes the uninterpretable features of EXPL. The participial (PRT) agrees with the direct object (DO) *fish*. Consider more closely the first stage of cycle,

- (b) [  $\alpha$  PRT [ catch [ DO several fish ]]]

Here, there is an agreement between PRT and DO. PRT, being adjectival, has number, gender and Case in its  $\varphi$ -set. DO has a full  $\varphi$ -set, so, number and gender for PRT are valued and get deleted. The Case does not get valued, so, PRT and DO cannot assign a Case value to one another.

In stage  $\beta$  of the derivation cycle, there is an agreement between probe and EXPL and also between probe and DO. The uninterpretable features of probe and goal get deleted. Chomsky raises an important question here- at stage  $\beta$ , because PRT's  $\varphi$ -features get deleted, they should be invisible to Match by the probe. Then, Case of PRT cannot be valued and the derivation should crash. But this does not happen.

To resolve this problem, Chomsky assumes that Spell-out takes place at the strong phase level. Now, the  $\varphi$ -feature of PRT would remain invisible at stage  $\beta$ . It is only at the strong phase level CP or vP that they disappear.

At stage  $\alpha$ , as PRT-DO match, the  $\varphi$ -features of PRT get valued, while at stage  $\beta$ , the Case features of PRT gets valued as probe T or v match PRT

(which is still visible). The match between probe and DO (goal) values the Case feature of DO and the feature of probe. The uninterpretable features, which are valued now, get eliminated at the strong phase level CP or  $\nu$ P as the Syntactic Object gets transferred to the phonological component.

## 4.2. Reflexive interpretation in Hindi-Urdu

Now let us analyze various constructions vis-à-vis reflexives in Hindi-Urdu.

### 4.2.1. Participial constructions

Consider the following sentences,

16. (a)  $ram_i$ -ne  $si:\dot{t}a_j$ -ko  $\text{\textcircled{a}pni}_{i/j}$   $b\text{\textcircled{a}rai}$   $k\text{\textcircled{a}r\text{\textcircled{t}}e}$   $hue$   $suna$   
 Ram-ERG Sita-DAT self's praise do-IMPF be-PF hear-pst.  
 'Ram<sub>i</sub> heard Sita<sub>j</sub> doing self's<sub>i/j</sub> praise.'

- (b)  $ram_i$ -ne  $si:\dot{t}a_j$ -ko  $\text{\textcircled{a}pne}_{i/j}$   $gh\text{\textcircled{a}r}$   $m\text{\textcircled{e}}$   $ghu\text{\textcircled{s}t\text{\textcircled{e}}$   $hue$   $\text{\textcircled{d}ek}^h\text{\textcircled{a}}$   
 Ram-ERG Sita-DAT self's house into enter-IMPF be-PF see-pst  
 'Ram<sub>i</sub> saw Sita<sub>j</sub> entering into self's<sub>i/j</sub> house.'

In both the sentences with participial clauses, the VP is non-finite, i.e. embedded T is  $\phi$ -incomplete. So, the VP is a weak phase. Now let us reflect on the structure of these sentences and then evaluate how the reflexive interpretation is arrived at.

17(a)

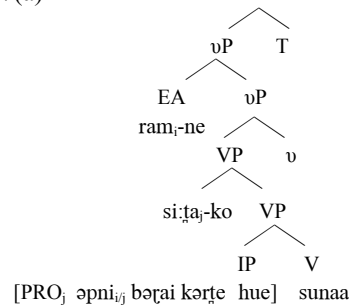

(b)

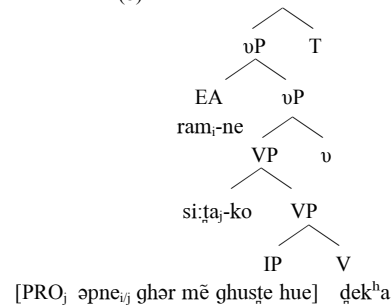

First consider the VP. The embedded T (i.e. probe) enters into an Agree relation with the reflexive *\text{\textcircled{a}pni}* (i.e. goal). By local c-command relation, the reflexive gets coindexed with PRO, which is in the Spec of the embedded T. PRO is controlled by *si:\dot{t}a* (i.e. it bears the  $\phi$ -features of *si:\dot{t}a* and hence coindexed with it. So, the reflexive *\text{\textcircled{a}pni}* is co indexed with *si:\dot{t}a*. As the embedded T is  $\phi$ -incomplete, it renders  $\nu$ P a weak phase and PIC (Phase-Impenetrability Condition<sup>6</sup>) does not hold here. Hence, the VP is accessible to further operations outside and its interpretation is at the matrix clause which counts for the next relevant phase for it. Now the matrix T (i.e. probe), which

is  $\phi$ -complete, enters into an Agree relation with the reflexive (i.e. goal). This operation does not delete the uninterpretable features of T as the reflexive is  $\phi$ -incomplete and the  $\phi$ -set of T remains intact. It has to again enter into a checking relation with the subject *ram* as a result of which the reflexive gets coindexed with *ram*. Hence, the reflexive *əpni* gets both *ram* and *si:ʔa* as its antecedents.

#### 4.2.2. Light verb / ( ECV ) constructions

Consider the following example,

18. (a) *nu:r<sub>i</sub>-ne əmina<sub>j</sub>-ko əpne<sub>i/j</sub> kəmre mē bhej ʔija*  
 Noor-ERG Amina-DAT self's room into send give-pst  
 'Noor<sub>i</sub> sent Amina<sub>j</sub> into self's<sub>i/j</sub> room.'

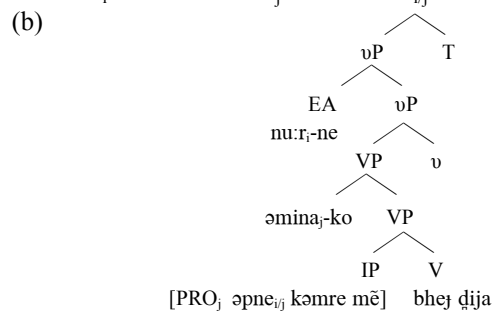

This is explained through the same analysis that explains the participial constructions.

#### 4.2.3. Object control Vs Subject control predicates

Consider the following examples,

19. (a) *ram<sub>i</sub>-ne si:ʔa<sub>j</sub>-ko [PRO<sub>j</sub> əpni<sub>i/j</sub> gaʔi lane-ko] kəha*  
 Ram-ERG Sita-DAT self's car bring-to say-pst  
 'Ram<sub>i</sub> asked Sita<sub>j</sub> to bring self's<sub>i/j</sub> car.'

Vs

- (b) *ram<sub>i</sub>-ne si:ʔa<sub>j</sub>-se [PRO<sub>i</sub> əpni<sub>i/\*j</sub> gaʔi lane-ka] vaʔaa kija*  
 Ram-ERG Sita-INSTR. self's car bring-GEN promise do-pst  
 'Ram<sub>i</sub> promised Sita<sub>j</sub> to bring self's<sub>i/\*j</sub> car.' (Kidwai: 2000)

The predicates *say* and *promise* are object and subject control predicates, respectively. Only in object control environments the reflexive is ambiguous in reference (as seen in the earlier examples also). Kidwai (2000) points out this 'feeding effect' with object control. Though she provides no convincing explanation for this, she notes that because PRO must necessarily be in [Spec, TP], it is the  $\phi$ -features of PRO that are relevant in determining in the possibility of X<sup>0</sup>-reflexive successive cyclic raising.



Now let us proceed with our analysis and see how it explains the above Object Vs Subject Controlled facts in Hindi-Urdu. The relevant structures for 19 (a) and (b) are following:

20 (a)

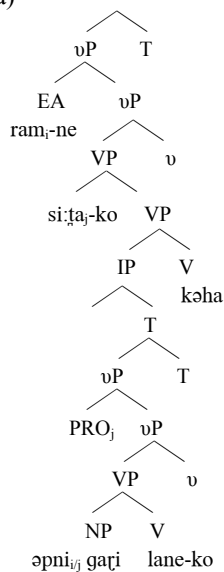

(b)

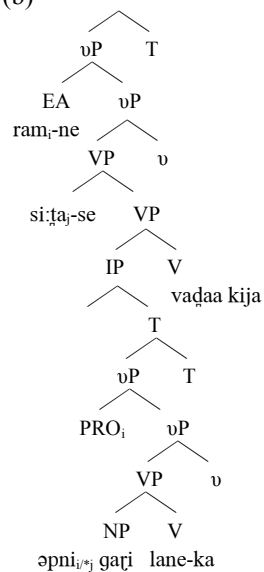

In the object controlled predicate the analysis is the same as in the participials and ECV constructions. Consider the subject controlled predicate with the structure (b),

PRO<sub>i</sub> here, bears the  $\varphi$ -features of the matrix subject. The reflexive *apni* can only get co indexed with the matrix subject *ram* in any of the two ways. If we consider the embedded clause, PRO is in the Spec. of the embedded TP, so, by the local c-command relation, the reflexive *apni* is co indexed with PRO which is co indexed with the matrix subject. On the other hand, as the embedded T is  $\varphi$ -incomplete, it renders the VP weak and the interpretation / evaluation of this phase is at the matrix phase, which is the next relevant (i.e. strong) phase for it. Again, the matrix T (i.e. probe) enters into an Agree relation with the reflexive, but the  $\varphi$ -set of T remains intact as the reflexive is  $\varphi$ -incomplete. T enters, then, into a checking relation with the matrix subject and gets its features deleted.

## 5. Conclusion

In this present paper, I have explored Hindi-Urdu binding facts regarding reflexives. Empirical inadequacies of previous research have also been shown. Within the minimalist framework, I have argued that the long distance interpretation for Hindi-Urdu monomorphemic reflexives involves the core operation AGREE. Moreover, I have exploited the notion of weak phase in order to analyze reflexive interpretations in participial, and ECV constructions as well as object and subject controlled predicates in Hindi-Urdu.

A final remark. The reflexive binding facts in Hindi-Urdu further suggest that weakness or strength of a phase does not follow from EPP. It surely can be a property of a phase but strength does not lie in its EPP-feature. It follows from the principles of feature-composition of the lexical verb, i.e. the VP determines whether  $v$  is  $\phi$ -incomplete or complete and that in turn determines T.

---

## Notes

<sup>1</sup>I am very much indebted to my supervisor Dr. Ayesha Kidwai for her suggestions and feedback as well as inspiration.

<sup>2</sup> $\beta$  is bound by  $\alpha$  iff  $\beta$  and  $\alpha$  are co indexed,  $\alpha$  c-commands  $\beta$  (and  $\alpha$  is in an A- position).

<sup>3</sup> $\alpha$  c-commands  $\beta$  iff the maximal projection dominating  $\alpha$  dominates  $\beta$ , and  $\alpha$  doesn't dominate  $\beta$ .

<sup>4</sup> $\alpha$  is the governing category for  $\beta$  iff  $\alpha$  is the minimal category containing  $\beta$ , a governor of  $\beta$ , and a SUBJECT accessible to  $\beta$ .

<sup>5</sup>There seems to be a dialect split as some speakers don't allow LD binding here. In examples 2-6, these speakers only allow matrix subject to be the antecedent for the possessive reflexives.

<sup>6</sup>PIC- For strong phase HP with head H: "In phase  $\alpha$  with head H, the domain of H is not accessible to operations outside  $\alpha$ , but only H and its edge." (Chomsky 2000:22)

## References

- Abbi, A. 1997. *Semantic Grammar of Hindi, Study of Reduplication*. New Delhi: Bahari Publications.
- Battistella, E. 1987. "Chinese Reflexivization: A Movement to INFL. Approach," *Linguistics*, **Vol. 27**: 987-1012.
- Chomsky, N. 1957. *Syntactic Structures*. The Hague: Mouton.
- Chomsky, N. 1981. *Lectures on Government and Binding*. Dordrecht: Foris.
- Chomsky, N. 1986a. *Barriers*. Cambridge MA: MIT Press.
- Chomsky, N. 1995. *The Minimalist Program*. Cambridge MA: MIT Press.
- Chomsky, N. 2000. "The Minimalist Inquiries: The Framework," *MIT Working Papers in Linguistics*, **Vol. 15**.
- Chomsky, N. 2001. "Derivation by Phase," *MIT Working Papers in Linguistics*, **Vol. 18**.

- 
- Cole, P., and L.-M. Sung 1994. "Head-Movement and Long-Distance Reflexives," *Linguistic Inquiry*, **Vol.** 25:355-406.
- Cole, P. G. Hermon and L.-M. Sung 1990. "Principles and Parameters of Long-Distance Reflexives," *Linguistic Inquiry*, **Vol.** 21:1-22.
- Davison, A. 1995. "Lexical Anaphora in Hindi-Urdu," In K. Wali, K. V. Subbarao, B. Lust and J. Gair (eds.) *Lexical Anaphora and Pronouns in Some South Asian Languages: A Principled Typology*. Berlin: Mouton de Gruyter.
- Everaet, M. 1988. "Inherent Reflexive Verbs and the 'zich'/'zich zelf'-distribution in Dutch," *Utrecht Working Papers in Linguistics*, **Vol.** 10:1-48.
- Haegeman, L. 1991. *Introduction to Government and Binding Theory*. Oxford: Basil Blackwell.
- Harley, H. 1996. "Events, Agents and the Interpretation of VP-shells," Ms. University of Arizona.
- Hornstein, N. 1995. *Logical Form*. London: Basil Blackwell.
- Hornstein, N. 1999. "On Movement and Control," *Linguistic Inquiry*, **Vol.** 30:69-96.
- Huang, C.-T. J. 1983. "A Note on Binding Theory," *Linguistic Inquiry*, **Vol.** 14:554-561.
- Huang, C.-T. J. and C. C. J. Tang. 1989. "On the Local Nature of the Long-Distance Reflexives in Chinese," *Proceedings of North-Eastern Linguistic Society*, **Vol.** 19:191-206.
- Jackendoff, R. 1990. "On Larson's Treatment of the Double Object Construction," *Linguistic Inquiry*, **Vol.** 21:427-456.
- Jaysheelan, K.A. 1996. "Anaphors as Pronouns," *Studia Linguistica*, **Vol.** 51.2: 186-234.
- Jonas, D. and J. Bobaljik. 1993. "Specs for Subjects: The Role of TP in Icelandic," *Papers on Case and Agreement I, MIT Working Papers in Linguistics*, **Vol.** 18:59-98.
- Kachru, Y. 1989. *Aspects of Hindi-Grammar*. New Delhi: Manohar Publications.
- Kayne, R. 1994. *The Antisymmetry of Syntax*. Cambridge, MA: MIT Press.
- Kidwai, A. 2000. *XP-Adjunction in Universal Grammar: Scrambling and Binding in Hindi-Urdu*. New York: Oxford University Press.
- Koopman, H. and D. Sportiche. 1991. "The Position of subjects," *Lingua*, **Vol.** 85:211-258.
- Larson, R. 1988. "On the Double Object Construction," *Linguistic Inquiry*, **Vol.** 19:335-91.
- Lidz, J. 1996. *Dimensions of Reflexivity*. Ph. D. Thesis. University of Sydney.
- Longobardi, G. 1994. "Reference and Proper Names: A Theory of N-Movement in Syntax and Logical Form," *Linguistic Inquiry*, **Vol.** 25.4:609-665.
- Mahajan, A. 1990. *On the A /A-bar Distinction and Movement Theory*. Ph.D. Thesis. MIT.
- Manning, C. 1994. "Argument Structure as a Locus for Binding Theory," Ms. University of Sydney.
- Manzini, R. and A. Roussou. 2000. "A Minimalist Theory of A-movement and Control," *Lingua*, **Vol.** 110:409-447.
- May, R. 1985. *Logical Form*. Cambridge, MA: MIT Press.
- Pica, P. 1987. "On the Nature of the Reflexivization Cycle," *Proceeding of North-Eastern Linguistic society*, 483-499. GLSA, Amherst.

- 
- Pollock, J.-Y. 1989. "Verb Movement, Universal Grammar and the Structure of IP," *Linguistic Inquiry*, **Vol.** 20:365-424.
- Reinhart, T. 1997. "Strategies of Anaphora Resolution," *OTS Working Papers*. University of Utrecht.
- Reinhart, T. and E. Reuland. 1993. "Reflexivity," *Linguistic Inquiry*, **Vol.** 24:657-720.
- Reinhart, T. and Y. Grodzinsky. 1993. "The Innateness of Binding and Coreference," *Linguistic Inquiry*, **Vol.** 24:69-102.
- Richa. 2003. *Possessive Reflexives and Pronominal in Hindi-Urdu and Indian Sign Language*. M.Phil. Dissertation. Jawaharlal Nehru University.
- Richards, N. 196. "Towards a Feature Movement Theory of Long Distance Anaphora," Ms. MIT.
- Rizzi, L. 1990. *Relativized Minimality*. Cambridge, MA: MIT Press.
- Tang, C. - C. - J. 1989. "Chinese Reflexives." *Natural Language and Linguistic Theory*, **Vol.** 7:93-121.
- Weibelhuth, G. 1995. (ed.) *Government and Binding Theory and the Minimalist Program*. Cambridge: Blackwell.

Richa  
Centre for Linguistics, Jawaharlal Nehru University (JNU), New Delhi, India  
rsrishti@gmail.com, srishti\_76@rediffmail.com

## Interpretable [person] in T and $\varphi$ -Incomplete Small v for Spanish

Miguel Rodríguez-Mondoñedo  
University of Connecticut

### 1. Introduction

Spanish is split in two dialects with respect to Existential Constructions (SEC). In Spanish Dialect I (SI, (1)) the verb has default value (3er person, singular), but in Spanish Dialect II (SII, (2)) the verb agrees with the accusative:

- |     |                                    |            |
|-----|------------------------------------|------------|
| (1) | Hubo dos pasteles en la fiesta     | <i>SI</i>  |
|     | was two cakes in the party         |            |
|     | There was two cakes in the party   |            |
| (2) | Hubieron dos pasteles en la fiesta | <i>SII</i> |
|     | were two cakes in the party        |            |
|     | There were two cakes in the party  |            |

In both dialects, the internal nominal (that corresponds to the so called “associate” in English) receives Accusative Case, as we can see from the presence of an accusative clitic (CL)—notice that there is agreement in SII (4a) even with the clitic:

- |     |                                       |            |
|-----|---------------------------------------|------------|
| (3) | a. Hubo dos pasteles en la fiesta     | <i>SI</i>  |
|     | was two cakes in the party            |            |
|     | There were two cakes in the party     |            |
|     | b. Los hubo                           |            |
|     | CL-PLU was                            |            |
| (4) | a. Hubieron dos pasteles en la fiesta | <i>SII</i> |
|     | were two cakes in the party           |            |
|     | There were two cakes in the party     |            |
|     | b. Los hubieron                       |            |
|     | CL-PLU were                           |            |

This seems to be a challenge for theories that link together Agreement and Case (like Chomsky 2000). In SII, the nominal seems to be in agreement with T, but T cannot be its case-licensor because T does not value Accusative.

I will present an analysis that supports the relation between Case and Agreement, and the operation Agree (Chomsky 2000) by proposing: a  $\phi$ -incomplete small  $v$  in *haber*-sentences, that is, a  $v$  with [number] and without [person]; an interpretable [person] feature in T in SII; and that T can probe small  $v$ .

I will use SI for the dialect without agreement, and SII for the one with agreement. When there is no indication, the sentence is good or bad in both dialects. In the present times, SI is predominant in Peninsular Spanish, whereas SII is predominant in Latin American Spanish. Keep in mind, however, that SI and SII are really shorthands for a family of dialects that share the corresponding phenomenon. Although I will present a correlation between the difference and other aspects of SI and SII, nothing prevents the dialects inside SI or SII to have differences in other aspects of their grammars. Treviño 2003 reports a SII dialect where, for a particular subset of *haber*-sentences, there is neither agreement nor cliticization. I won't discuss this here, but this can be solved by resorting to inherent case, given the assumption that nominals with inherent case do not trigger agreement (Chomsky 2000: fn 88)—see Rodríguez-Mondoñedo 2006 for discussion.

## 2. A Small $v$ in Existentials

Under Chomsky's Agree/Case system, given that we have an accusative object, there is no choice but to postulate a functional head with  $\phi$ -features and the ability to probe the nominal:

- (5) a. Habían dos hombres en la habitación  
 Were two men in the room  
 There is a man in the room
- b. [TP T- $\phi$  [vP v- $\phi$  [VP hay [SC [dos hombres] [en la habitación]]]]]

Provisionally, let me propose that the operation Agree applies as follows:

- (6) a. Match
- |               |   |                     |  |
|---------------|---|---------------------|--|
| $v$           |   |                     |  |
| [u $\phi$ : ] | → | [dos hombres]       |  |
|               |   | [ $\phi$ : 3p, plu] |  |
|               |   | [uCase: ]           |  |

## b. Valuation

$$\begin{array}{c} v \\ [\varphi: \mathbf{3P, PLU}] \end{array}$$

$$\begin{array}{c} [\text{dos hombres}] \\ [\varphi: \mathbf{3p, sing}] \\ [\text{Case: ACC}] \end{array}$$

This is possible if we dissociate the ability to have an external argument from the ability to value accusative; therefore, rejecting Burzio's Generalization—see the papers in Reuland 2002, among several others, for additional cases of Burzio's Generalization violations).

A remaining problem is how to value the  $\varphi$ -features of T.

### 3. Checking $\varphi$ -T

According to Chomsky, in English, once T has valued its  $\varphi$ -features by probing the nominal, the expletive THERE, that is  $\varphi$ -incomplete, can probe T and values its [person] feature. So, *valued heads* (like T) can be a GOAL.

Given this, we can value  $\varphi$ -T using  $v$  as goal:

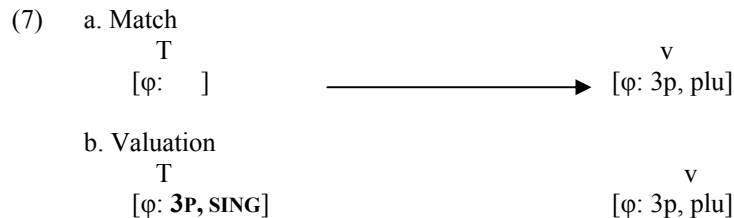

Let's now return to the dialectal differences with respect to agreement.

Remember that there are two dialects in Spanish with respect to agreement in existential constructions:

- (8) Hubo dos hombres en la fiesta *SI*  
 was two men in the party  
 There were two men in the party
- (9) Hubieron dos hombres en la fiesta *SII*  
 were two men in the party  
 There were two men in the party

Under the current assumptions, the explanation for SII (9) is straightforward: the nominal value the  $\varphi$ -features of  $v$ , and  $v$  values the  $\varphi$ -features of T. However, (8) shows that in SI no relevant goal must be available for T, because T gets a

default value. Given that in both cases we have  $v$  (because there is ACC), the question is what could avoid the agreement here?

In Spanish T can get a default value [3p, SING] if no  $\phi$ -head is available in the c-commanded domain.

- (10) a. Llueve  
It rains
- b. [TP T- $\phi$  [VP Llueve]]

Given that (10) is possible in SI and SII, the question is what makes possible a default value in SI but not in SII in the case of Existential constructions. To answer that, let's turn to some restrictions on the internal nominal of *haber*-sentences.

#### 4. Restrictions on the Internal Nominal of *haber*.

Nominals that are specified with [person] are not possible inside *haber*-sentences:

- (11) a. Lo/La                      había              en la habitación  
CL-MAS/CL-FEM              was              in the room
- b. \*Me/Te/Nos                  había              en la habitación  
Me/Te/Us                      was              in the room  
There was me/you/us in the room
- (12) a. \*Hay                      Juan  
Is                              John  
There is John
- b. \*Has                          te/tú  
are                              you  
There is you.

Notice that, contrary to their English counterpart, [person] elements in Spanish are not possible there even with list-readings. It is not the case that in (15-16) we have a different reading, these sentences are simply ungrammatical.

I contend that the reason for this is that small  $v$  appears without a [person] feature, and just with [number]:



- (13)  $v$   
[number]

That means that only objects that are not specified for [person] will be allowed there. If an internal nominal is specified for person, small  $v$  will be able to probe it and then to value its own [number] feature, but it will not be able to value the [case] feature of the object, given Chomsky's (2000, 2001) suggestion that incomplete  $\phi$ -features cannot value [case]—see also Bejar 2003—that I will express in this way:

- (14) Only probes  $P$  that match all the relevant features of a goal  $G$  can value the [case] feature of  $G$ .

So far, this is common to SI and SII. A possible problem here is that now small  $v$  won't be able to value the  $\phi$ -features of  $T$  (because now it is  $\phi$ -incomplete). This is actually a welcome state of affairs for SI. Given that small  $v$  cannot value the  $\phi$ -features of  $T$ , then  $T$  must resort to some default value.

Let's now turn to SII.

There is a related difference between SI and SII. This is not possible in SI, but it's possible in SII:

- |      |                    |                                     |            |
|------|--------------------|-------------------------------------|------------|
| (15) | Habemos            | dos estudiantes en la clase         | <i>SII</i> |
|      | Habéis             |                                     |            |
|      | Were-1P-PLU        | two students in the class           |            |
|      | Were-2P-PLU        |                                     |            |
|      | <i>Lit:</i> We/You | there are two students in the class |            |

It is important to notice that in (15) it is impossible to put an overt subject (neither preverbal nor postverbal):

- |      |    |             |             |                             |            |
|------|----|-------------|-------------|-----------------------------|------------|
| (16) | a. | *Nosotros   | habemos     | dos estudiantes en la clase | <i>SII</i> |
|      |    | We          | were-1P-PLU | two students in the class   |            |
|      | b. | *Habemos    | nosotros    | dos estudiantes en la clase | <i>SII</i> |
|      |    | Were-1P-PLU | we          | two students in the class   |            |

Given that [person] nominals are not allowed under *haber*, the question is where this [1p] and [2p] comes from? The situation is even more puzzling if we take in consideration that this dissociation between the person in  $T$  and the person in the nominal agreeing with  $T$  is possible with all other verbs in SI and

SII (Hurtado 1984, Olarrea 1996):

(17) Los estudiantes hemos asistido a la clase regularmente  
habéis asistido

The students have-1P-PLU attended the class regularly  
have-2P-PLU attended

We, the students, have attended the class regularly  
You, the students, have attended the class regularly

The question is why SI does not allow this dissociation with *haber*—of course, this is the same question regarding why in SI does not agree with the internal nominal but SII does.

Remember that we have two questions to answer:

- (i) How to value the  $\phi$ -features of SII T, given that small *v* is  $\phi$ -incomplete.
- (ii) How to account for the variability in [person] with SII SEC.

I propose that we can solve both questions at the same time.

### 5. An Interpretable [person] in T

The standard analysis for (17) is to assume that the overt nominal is left-dislocated and that there is a *pro* in [Spec, IP] that is responsible for the features in T (Olarrea 1996, among others). I think this analysis works fine for SI. But for SII this cannot work, at least no in SEC. If we propose a *pro* with [1p] or [2p] as internal nominal (with the overt nominal right-dislocated, let's say) we cannot explain (15-16): remember that nominals specified for [person] are not allowed in *haber*-sentences.

Notice further that in (15) the person in T is interpretable, in the sense that it means that the speaker is part of the two students. So, an expletive won't be appropriate to carry on this meaning. We cannot say either that in (15) we have a regular *pro* as external argument of *haber*, since this will predict that it could be replaced by a lexical pronoun (as any other instance of *pro* in Spanish), which is not possible as (16) shows.

I propose that in SII the effects in (15-16) are triggered by an interpretable [person] feature in T. This will solve both problems. First in SII, given that the [person] feature in T is interpretable, we don't need to value it (it has already a value). So only the [number] feature need to probe the small *v*, which is fine



## 6. Differential Object Marking

A remaining problem is why (**Error! Reference source not found.**) cannot be rescued by using the preposition A (23a), as any specific and animate object in Spanish (23b):

- (23) a. \* Bueno, hay a Juan  
Well, there is to John
- b. María besó a Juan  
Mary kissed to John  
Mary kissed John

But this is, in fact, evidence in favor of the analysis, if we assume that with all transitive verbs in Spanish the small *v* has only [number] and no [person]:

- (24)  $v$   
[number]

In this way, no [person] nominal would be allowed to value its Case against small *v*.

Under Bošković's 2005 version of the Phase, if a nominal cannot check its Case inside  $vP$ , it must move out to avoid being spell-out with an unvalued feature, creating a new specifier of  $vP$  to escape:

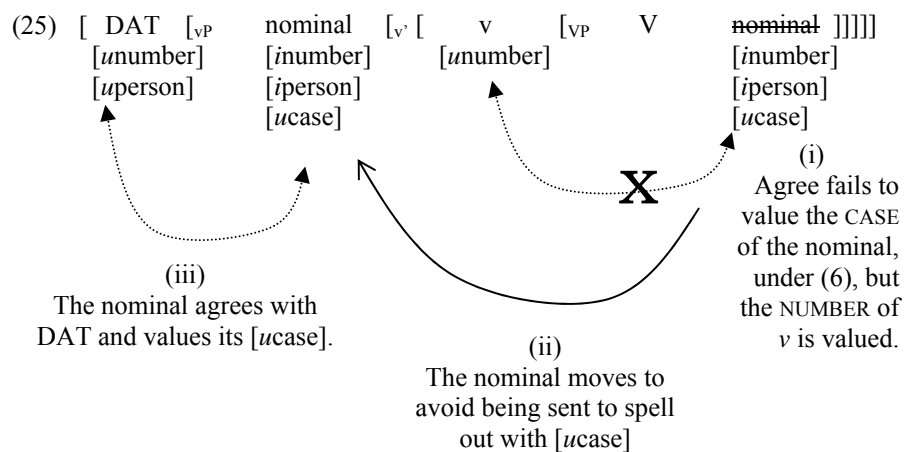

We can assume that this is what happens in Spanish: [person] nominals move throughout [Spec,  $vP$ ] to an additional head, which gives them Dative Case (so

we explain the A). This is not available in *haber*-sentences because they have no external argument—they are subjectless (Suñer 1982, among many others)—therefore it is unable to have specifiers to be used as escape-hutch:

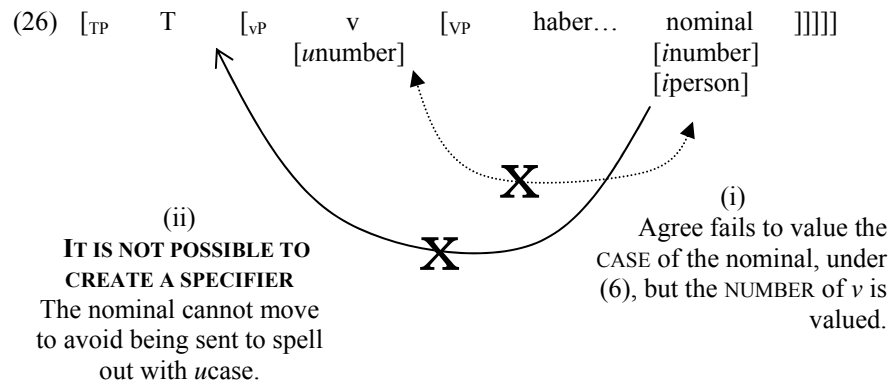

This means that the incompleteness of small *v* is not a marginal aspect of *haber*-sentences, but a core property of Spanish *v*P.

## 8. Conclusions

The system developed here shows that the agreement with the Accusative in SII SEC does not challenge Chomsky's Agree system, once we allow a small *v* in these constructions. We need to allow different types of small *v*, besides the traditional one, and an interpretable  $\phi$ -feature in T.

Given that the case of the internal nominal in existential constructions is valued in a lower position (not by T), the system provides a way to encode the insight of the Partitive Case Hypothesis (Belletti 1988, Lasnik 1992) in the Agree system (although with different technical details).

The Differential Object Marking phenomenon and the restrictions on list-readings in Spanish *haber*-sentences have the same source, that is, the incompleteness of small *v*.

## References

- Bejar, Susana. 2003. *Phi-Syntax: A theory of Agreement*, University of Toronto: PhD Dissertation.
- Belletti, A. 1988. "The Case of unaccusatives". *Linguistic Inquiry* 19:1-34.
- Boeckx, Cedric. 2003. *Intricacies of Icelandic Agreement*. Ms.

- Bošković, Z. 2005. *On the Locality of Move and Agree*. UConn Occasional Papers in Linguistics 3.
- Chomsky, Noam. 2000. "Minimalist inquiries: the framework". In *Step by step: essays on minimalist syntax in honor of Howard Lasnik*, eds. Roger Martin, David Michaels and Juan Uriagereka, 89-155. Cambridge, Mass: MIT Press.
- Chomsky, Noam. 2001. "Derivation by Phase". In *Ken Hale: A Life in Language*, ed. Michael Kenstowicz, 1- 52. Cambridge, Mass.: MIT Press.
- Hurtado, Alfredo. 1984. "La hipótesis de la discordancia". *Los clíticos del español y la gramática universal. Supplement of the Revista Argentina de Lingüística*:56- 77.
- Lasnik, Howard. 1992. "Case and expletives: Notes toward a parametric account." *Linguistic Inquiry* 23:381-405.
- Olarrea, Antxon. 1996. Pre- and Postverbal Subject Position in Spanish: A Minimalist Account, University of Washington: PhD Dissertation.
- Reuland, Eric ed. 2000. *Arguments and Case. Explaining Burzio's Generalization*. Amsterdam: John Benjamins.
- Rodríguez-Mondoñedo, Miguel. 2006. "Spanish Existentials and other Accusative Constructions". In: Boeckx *Minimalist Essays*. Amsterdam: John Benjamins. 326-394
- Suñer, Margarita. 1982. *Syntax and Semantics of Presentational Sentence-Types*. Washington: Georgetown University Press.
- Treviño, Esthela. 2003. "On the Subjecthood Issue of Existential Haber". In *Linguistic Theory and Language Development in Hispanic Language*, eds. Silvina Montrul and Francisco Ordóñez, 178-192. University of Illinois at Urbana-Champaign: Cascadilla Press.

*Miguel Rodríguez-Mondoñedo*  
*University of Connecticut*  
*337 Mansfield Road*  
*Storrs, CT 06226-1145*  
*miguelmrm@gmail.com*

# The Scalar Sensitivity of the Japanese Scalar Additive Particles

**Osamu Sawada**  
University of Chicago

## 1 Introduction

This paper investigates the scalar properties and conventional implicatures of the Japanese NPI EVENS—*hitotu* and 1-NCL—and argues that ‘scalar sensitivity’ as well as ‘polarity sensitivity’ plays an important role in capturing the semantics/pragmatics of the Japanese scalar additive particles.<sup>1</sup> Let us observe the following sentences (Scalar Prt stands for a scalar particle and NCL stands for a numeral classifier):

- (1) Taro wa biiru *hitotu* nom- e- nai.  
 Taro Top beer Scalar Prt drink can not  
 ‘Taro cannot even drink beer.’ (Event scale reading)
- (2) Taro wa biiru *i- ppai* nom- e- nai.  
 Taro Top beer one NCL (cup) drink can not  
 ‘Taro cannot even drink beer.’ (Event scale reading)  
 ‘Taro cannot drink even ONE glass of beer.’ (Existential scale reading)

The *hitotu* construction in (1) has only one reading, the event scale reading, while

the 1-NCL construction in (2) has two readings, the ‘event scale’ reading and the ‘existential scale’ reading. The event scale reading is, roughly, a reading that forces the hearer to posit contextually relevant events other than the text event, whereas the ‘existential scale reading’ is a reading that can be paraphrased as *zenzen...nai* ‘not...at all’ or 1-NCL-*mo* ‘even 1...,’ forcing the hearer to posit a numeral scale (Sawada in press).<sup>2</sup>

Since Karttunen and Peters (1979), the scale invoked by a scalar additive particle (e.g. English *even*) has often been defined in terms of the ‘likelihood’ of propositions. I argue that the scale of likelihood alone is not sufficient to capture the difference of conventional implicature between the *hitotu* and 1-numeral classifier constructions. I will argue that besides the likelihood scale, the variation of scale consisting of a focused part and its alternatives plays an important role in capturing the semantic behavior of each particle. I will propose that unlike a language like English, in Japanese there are two types of EVEN items, i.e. the Semantic EVEN and the Pragmatic EVEN. Roughly speaking, the semantic EVEN creates a ‘quantitative’ scale (Horn 1972), while the pragmatic EVEN creates a ‘context-dependent’ scale (Fauconnier 1975; Hirschberg 1985).

This paper proceeds as follows. In section 2, we will consider the similarities and differences between the two focus particles. It will be shown that the distinction between *hitotu* and 1-NCL can be captured naturally in terms of grammaticalization. In section 3 and 4, we will clarify the conventional implicatures of the *hitotu* and 1-NCL constructions. Section 5 considers the scalar sensitivity of the focus particles and proposes that there are two types of EVEN items in Japanese i.e. the Semantic EVEN and the Pragmatic EVEN. I will argue that *hitotu* can only function as the pragmatic EVEN, while 1-NCL can function as either the Semantic Even or the Pragmatic EVEN depending on the position of a focused part. Finally, in section 6 it will be shown that the distinction between the semantic EVEN and the pragmatic EVEN is general enough to apply to other



EVEN items in Japanese. Section 7 concludes the paper and discusses some remaining issues.

## 2 Similarities and Differences between the Two Particles

This section considers the similarities and the differences between the two NPI EVENs. It will be shown that the *hitotu* and 1-classifier constructions share some conventional properties but are different in terms of ‘multifunctionality’ and ‘degree of grammaticalization.’

### 2.1 Similarities between *hitotu* and 1-NCL

The *hitotu* and 1-NCL constructions share the following conventionalized (idiomatic) characteristics.

First, *hitotu* and 1-NCL are NPIs. They must appear with the negative particle *nai* (Nabeshima 2003; Sakamoto 2002; Sawada in press), as shown in:

(3) \*Taro wa biiru {*hitotu* /*i-ppai*} nom-eru.

Taro Top beer Scalar Prt /one-NCL (cup) drink-can

Notice that they cannot appear in other downward entailing contexts, such as the protasis of conditionals, as in (4):

(4)\*Taro wa biiru *hitotu* nome-ba, yooki-ni naru.

Taro Top beer Scalar Prt drink conditional happy become

‘(lit) If Taro drinks even beer, he becomes happy.’

Second, no case markers appear in these constructions, as in (5a) and (6a):

(5) a.\*Taro wa biiru *o* {*hitotu* /*i-ppai*} nom -e- nai.

Taro Top beer ACC Scalar Prt / one NCL (cup) drink-can-not

- b. Taro wa biiru *o* *itt-pai* mo nom-e-nai.  
 Taro Top beer ACC 1-classifier (cup) even drink-can-not  
 ‘Taro cannot even drink ONE glass of beer.’
- (6) a. \*Chiri ga *hito-tu* nai.  
 Dust Nom one NCL not-exist  
 b. Chiri ga *hito-tu* mo nai.  
 Dust Nom one NCL even not-exist  
 ‘There is not even a speck of dust/There is not even ONE speck of dust.’
- Sentences (5a) and (6a), but not (5b) and (6b), are unacceptable because the accusative case *o* and the nominative case *ga* appear in each sentence. (5b) and (6b) are acceptable because the sentences belong to an ordinary numeral classifier construction with the focus particle *mo*. In (5b) and (6b) the scalar particle *mo* contributes to the interpretation of EVEN.<sup>3</sup>
- Third, the noun before *hitotu* or 1-NCL must be a type (kind), but not a token. Thus (7) is not acceptable, because the proper noun *Hanako* is used.<sup>4</sup>
- (7)\*Taro wa *Hanako* {*hitotu* /*hito-ri*} yoba -naka-tta.  
 Taro Top Hanako scalar Prt /one NCL (person) invite-not -past  
 ‘Taro didn’t invite even Hanako.’

## 2.2 Differences: multifunctionality and the degree of grammaticalization

Although *hitotu* (=1) and 1-NCL (=2) share some similarities, I will argue that they must be regarded as different scalar particles in terms of ‘multifunctionality’ and ‘degree of grammaticalization.’ As for the multifunctionality, the *hitotu* construction has one reading, the event scale reading, while the 1-NCL construction has two readings, i.e. the event scale reading and the existential reading. If we consider the difference in terms of grammaticalization, it is possible to view *hitotu* as more grammaticalized than 1-NCL. Thus, *tu* in (1) has

lost its status as an NCL and *hitotu* itself becomes a scalar particle, whereas *pai* in (2) remains a numeral classifier (Sawada in press). The *tu* in (1) should not be regarded as a numeral classifier because the numeral classifier *tu* can only be used to count things that are “inanimate and separable” objects (Mano 2001) and the noun *biiru* (beer) does not have such semantic features (*biiru* is inanimate but not separable).

It is important to notice that sentence (8) is an instance of the 1-NCL construction (=2):

(8) Kono doresu ni wa simi *hito-tu* nai.

This dress in Top stain one-NCL not-exist

‘There is not even a stain on this dress.’ (Event scale reading)

‘There is not even ONE stain on this dress.’ (Existential reading)

(8) has two readings because the *tu* in (8) is a numeral classifier. Here, it can count a *simi* (stain), which is ‘inanimate and separable’ (Mano 2004).

The difference between *hitotu* in (1) and *hito-tu* in (8) suggests that the grammaticalization must be captured as a ‘cline’ (Hopper 1991, Hopper and Traugott 2003), as shown in Figure (9):

(9) **From classifier to scalar particle**

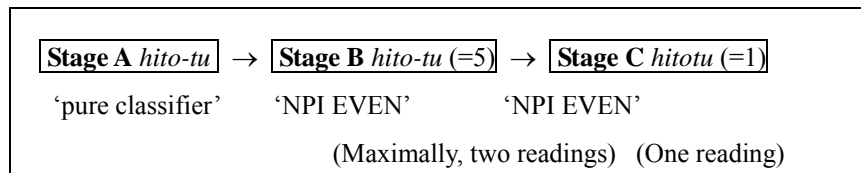

(10) is an example of stage A:

(10) Taro wa ringo o hito-tu tabe-ta.

Taro top apple Acc one-NCL (INANI, Separable) eat-past

‘Taro ate one apple.’

Notice that (10) does not have a meaning of scalar additive particle. In stages B and C, on the other hand, there is a meaning of scalar additive particle. However,

they are different in terms of the degree of grammaticalization. In stage B, the status of numeral classifier remains, while in stage C the function of numeral classifier has been lost.<sup>5</sup> As the following figure shows, there are many instances of the 1-numeral classifier construction:

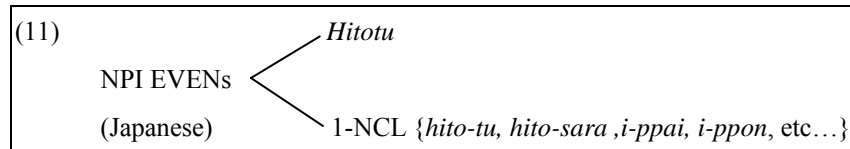

This suggests that *tu* is a special numeral classifier that can be **decategorized**.

### 3 Conventional Implicature of the *Hitotu* Construction

The following examples are instances of the *hitotu* construction:

- (12) Saikin isogasii node, Taro wa sanpo *hitotu* deki-nai.  
 These days busy because Taro Top walk Scalar Prt cannot  
 ‘Because Taro is busy these days, he cannot even take a walk.’
- (13) Hanako wa ryoori *hitotu* deki -nai.  
 Hanako Top cooking Scalar Prt do-can -not  
 ‘Hanako cannot even cook.’
- (14) Kare wa aisatu *hitotu* si-nai.  
 He Top greeting Scalar Prt do not  
 ‘He does not even offer a greeting.’

The above examples have the event scale reading. The conventional implicature of the *hitotu* construction in (12) can be represented as follows:

- (15) Conventional implicatures of (12)
- a.  $\exists x [C(x) \wedge x \neq \textit{sanpo} \text{ (‘walking’)} \wedge \neg (\text{Taro can do } x)]$
  - b.  $\forall x [C(x) \wedge x \neq \textit{sanpo} \text{ (‘walking’)} \rightarrow \text{unlikelihood (Taro does } x) > \text{unlikelihood (Taro takes a walk)}]$

The conventional implicature in (15a) says that there are other  $x$  under consideration besides walking and Taro cannot do  $x$ . The conventional implicature in (15b) says that for all  $x$  under consideration besides ‘walking’, the unlikelihood that Taro does  $x$  is greater than the unlikelihood that Taro takes a walk. That is to say, taking a walk is the least unlikely (most likely) event in a given context.

I use a scale of ‘unlikelihood’ rather than ‘likelihood’ in the conventional implicature because I would like to show visually that *hitotu* is a ‘minimizer.’ That is, it associates with a positive proposition that is ranked as bottom (or lowest) on the scale of ‘unlikelihood’ (cf. Rullmann 2006).

#### 4 Conventional Implicature of the 1-NCL Construction

The following example is an instance of the 1-NCL construction:

(16) Taro wa tii syatu *iti-mai* mo-ttei-nai.

Taro Top T-shirt one NCL (sheet) have-State-not

‘Taro does not even have a T-shirt.’ (Event scale reading)

‘Taro does not even have ONE T-shirt.’ (Existential scale reading)

The multiple conventional implicatures in (16) can be represented as follows:

(17) Conventional implicatures of ‘event scale reading’ in (16)

a.  $\exists x [C(x) \wedge x \neq \text{T-shirt} \wedge \neg (\text{Taro has } x)]$

b.  $\forall x [C(x) \wedge x \neq \text{T-shirt} \rightarrow \text{unlikelihood}(\text{Taro has } x) > \text{unlikelihood}(\text{Taro has a T-shirt})]$

(18) Conventional implicatures of ‘existential scale reading’ in (16)

a.  $\exists n [C(n) \wedge n \neq \text{one} \wedge \neg (\text{Taro has } n \text{ T-shirt})]$

b.  $\forall n [C(n) \wedge n \neq \text{one} \rightarrow \text{unlikelihood}(\text{Taro has } n \text{ T-shirt}) > \text{unlikelihood}(\text{Taro has one T-shirt})]$

Notice, however, that the 1-NCL construction does not always have two readings:

(19) Sora ni wa kumo *hito-tu* nai.

Sky to Top cloud one NCL not-exist

‘\*There is not even a cloud in the sky.’ (Event scale reading)

‘There is not even ONE cloud in the sky.’ (Existential scale reading)

(20) Taro no heya ni wa rajio *iti-dai* nai.

Taro GEN room to Top radio one NCL (flat object) not

‘Hanako does not even have a radio.’ (Event scale reading)

‘?? Hanako does not even have ONE radio.’ (Existential scale reading)

(19) has only the existential scale reading and (20) has only the event scale reading. The reason why they do not each have two readings is that in each case, one of the readings does not satisfy the existential presupposition, according to our world knowledge. Thus, in (19) it is difficult to posit elements other than *kumo* (cloud) and in (20) it is difficult to posit more than one *rajio* (radio) according to our encyclopedic knowledge.

## 5 Scalar Sensitivity of the Focus Particles

Since Karttunen and Peters (1979), the scale invoked by a scalar additive particle (e.g. English *even*) has often been defined in terms of the ‘likelihood’ of the propositions (Actually, as noted above, we have so far used an ‘unlikelihood’ scale but this does not make a large difference.)

However, the scale of (un)-likelihood is too powerful to capture the semantic behaviors of *hitotu* and 1-NCL appropriately. The propositional scale of ‘(un)likelihood’ cannot explain why *hitotu* cannot have an existential reading. It is necessary to posit a variation of the intra-propositional scales, consisting of a ‘focused part’ and ‘its alternatives.’

There are two types of EVEN items in Japanese, the semantic EVEN and the pragmatic EVEN. I will define each EVEN as follows:

- (21) a. Semantic EVEN: The Semantic EVEN is a scalar particle that focuses on a numerical noun (measure phrase) and creates a semantic (quantitative) scale (Horn 1972).
- b. Pragmatic EVEN: The Pragmatic EVEN is a scalar particle that focuses on an element other than numerical nouns and creates a context-dependent scale (Fauconnier 1975; Hirschberg 1985).

It is possible to consider that *hitotu* is the pragmatic EVEN, but 1-NCL can be ambiguous between the semantic EVEN and the pragmatic EVEN.<sup>6</sup> Thus, *iti-mai* (1-NCL) in (22) is ambiguous between the semantic EVEN and the pragmatic EVEN, depending on the position of a focused part:

- (22) a. Taro wa [tii syatu]<sub>F</sub> iti-mai mo-ttei-nai. (Pragmatic EVEN)  
 Taro Top T shirt one NCL (sheet) have-state-not  
 ‘Taro does not even have a T-shirt.’
- b. Taro wa tii syatu [iti-mai]<sub>F</sub> mo-ttei-nai. (Semantic EVEN)  
 Taro Top T shirt one NCL (sheet) have-state-not  
 ‘Taro does not even have ONE T shirt.’

If the focused element is *tii syatu* (T-shirt) as in (22a), the sentence will have a pragmatic scale, and if the focused element is *iti-mai* (1-NCL), it will have a semantic scale.<sup>7</sup>

However, *hitotu* is not ambiguous. It can only focus on an element other than numeral nouns:

- (23) a. Taro wa [tii syatu]<sub>F</sub> hitotu mo-ttei-nai. (Pragmatic EVEN)  
 Taro Top T shirt scalar Prt have-state-not  
 ‘Taro does not even have a T-shirt.’
- b. \* Taro wa tii syatu [hitotu]<sub>F</sub> mo-ttei-nai.  
 Taro Top T-shirt scalar Prt have-state-not

Furthermore, the following sentence also supports the idea that *hitotu* is a pragmatic EVEN:

- (24)\* Taro wa [tii syatu iti-mai] *hitotu* mo-ttei-nai.  
 Taro Top T-shirt one-NCL (sheet) scalar Prt have-state-not  
 ‘lit. Taro does not even have one T-shirt.’

## 6 Typology of Japanese EVEN Items

The distinction between the semantic EVEN and the pragmatic EVEN plays an important role in clarifying the lexicalization patterns of other Japanese focus particles, such as *sae*, *made*, and *mo*.

*Sae* and *mo* are different from *made* in polarity sensitivity. *Made* can only be used in the positive environment in contrast with *sae* and *mo* (Noda 1995: 27):

- (25) a. Taro wa [biiru]<sub>F</sub> {*sae/made/mo*} nom-eru. (Positive)  
 Taro Top beer scalar Prt drink-can  
 ‘Taro can even drink beer.’  
 b. Taro wa [biiru]<sub>F</sub> {*sae/\*made/mo*} nom-e-nai. (Negative)  
 Taro Top beer scalar Prt drink-can-not  
 ‘(lit.) Taro cannot even drink beer.’

However, *sae* and *made* are the same in that they are pragmatic EVENS. They cannot focus on numerical nouns unlike *mo*:

- (26) a. Taro wa biiru o [go-hai]<sub>F</sub> {*\*sae/\*made/mo*} nom-eru.<sup>8</sup> (Positive)  
 Taro Top beer Acc five-NCL Scalar Prt drink-can  
 ‘(lit) Taro can even drink FIVE glasses of beer.’  
 b. Taro wa biiru o [i-pai]<sub>F</sub> {*\*sae/\*made/mo*} nom-e-nai. (Negative)  
 Taro Top beer Acc one-NCL Scalar Prt drink-can-not  
 ‘(lit) Taro cannot even drink ONE glass of beer.’



Notice that *made* in (26b) violates both scalar sensitivity and polarity sensitivity.

The following figure shows the similarities and the differences among the five focus particles, i.e. *sae*, *made*, *mo*, *hitotu*, and 1-NCL:

(27)

	<b>NPI-EVEN</b>	<b>PPI-EVEN</b>
<b>Pragmatic Even</b>	<i>hitotu</i> , 1-NCL, <i>sae</i> , <i>mo</i>	<i>sae</i> , <i>mo</i> , <i>made</i>
<b>Semantic Even</b>	1-NCL, <i>mo</i>	<i>mo</i>

Interestingly, there seems no EVEN item that can only function as a Semantic EVEN.

## 7 Conclusion

This paper investigated the scalar properties and conventional implicatures of the Japanese NPI EVENS—*hitotu* and 1-NCL—and argued that ‘scalar sensitivity’ as well as ‘polarity sensitivity’ plays an important role in capturing the semantics/pragmatics of the Japanese scalar additive particles. I argued that Japanese has two kinds of Evens, the semantic EVEN and the pragmatic EVEN.

In a future study, I would like to consider the similarities and differences between the scalar particles and the ‘wh-scalar particle’ (Nakanishi 2007), as in:

(28) a. Saikin isogasii-node nani {*hitotu/mo*} deki-nai.

These days busy because what Scalar Prt can-not

‘Because I am busy these days, I cannot do anything.’

b. Saikin isogasii-node sanpo {*hitotu/mo*} deki-nai.

These days busy because walking Scalar Prt can-not

‘Because I am busy these days, I cannot even take a walk.’

It seems that the ‘wh-scalar particle’ can only have a qualitative scale (Nakanishi 2007) and it is similar to the pragmatic EVEN.

### Acknowledgement

I would like to thank Chris Kennedy, Anastasia Giannakidou, Keiko Yoshimura, Hotze Rullmann, Harumi Sawada, Jun Sawada and the participants in WECOL 2006 for their insightful comments and suggestions.

### Notes

1. I use EVEN to refer to the item crosslinguistically, following Giannakidou (to appear).
2. Sawada (in press) uses the term ‘emphasis of negation’, which corresponds to the existential scale reading.
3. There is a question as to why the case markers *ga* and *o* cannot occur in the *hitotu* and 1-NCL constructions. It seems that in the *hitotu* and 1-NCL constructions, the noun that has a grammatical function of subject or object is not topicalized, in contrast to the ordinary numeral classifier construction:

- (i) Tiri *hito-tu* nai.  
 Dust one NCL not-exist  
 ‘There is not even a speck of dust.’ / ‘There is not even ONE speck of dust.’
- (ii) Tiri *ga hito-tu mo* nai.  
 Dust Nom one NCL even not-exist  
 ‘There is not even ONE speck of dust.’

In (i) the speaker does not topicalize the ‘dust.’ What the speaker in (i) wants to assert is that the place is very clean. In (ii), on the other hand, the speaker topicalizes the noun. Therefore, in a context where the speaker is searching for dust, sentence (i) is not natural but (ii) is.

4. Notice that the animate noun can appear in the constructions:

- (i) a. Taro wa kodomo *hitotu* manzokuni sodate rare- nai.  
 Taro Top child Scalar Prt sufficiently bring up can-not  
 ‘Taro cannot even bring up a child sufficiently.’
- b. Taro wa kodomo *hito-ri* manzokuni sodare rare- nai.  
 Taro Top child one-NCL (person) sufficiently bring up can-not  
 ‘Taro cannot even bring up a child sufficiently.’

‘Taro cannot even bring up ONE child sufficiently.’

This suggests that the distinction between type and instance, but not animacy, is crucial.

5. I assume that this cline is also valid diachronically.

6. The distinction between the semantic and pragmatic scale plays an important role in *any*. Lee and Horn (1995) argue that NPI *any* creates a ‘quantity’ scale and FC *any* creates a ‘kind’ scale, which is a context-dependent scale.

7. It may be possible consider that there is a null semantic EVEN if the numerical noun is focused, but here I consider that there is not such null operator.

8. Note that (26a) is acceptable if *made* is interpreted as ‘up to’ (Yoshimura p.c.).

## References

- Fauconnier, Gilles. 1975. ‘Pragmatic Scales and Logical Structure’, *Linguistic Inquiry* 4: 353-75.
- Fillmore, Charles.J., Paul Kay, and Mary Catherine. O’Connor. 1988. ‘Regularity and Idiomaticity in Grammatical Constructions: The Case of ‘Let Alone’’, *Language* 64: 501-538.
- Giannakidou, Anastasia. To appear. ‘The Landscape of EVEN’, *Natural Language and Linguistic Theory*.
- Hirschberg, Julia. 1991. *A Theory of Scalar Implicature*, New York and London: Garland Publishing.
- Hopper, Paul. J. 1991. ‘On Some Principles of Grammaticalization’, In Traugott, Elizabeth C. and Bernd, Heine (eds.), *Approaches to Grammaticalization*, 17-35. Amsterdam/Philadelphia: John Benjamins.
- Hopper, Paul. J. and Elizabeth. C Traugott. 2003. *Grammaticalization* (second edition). Cambridge: Cambridge University Press.
- Horn, Laurence R. 1972. *On the Semantic Properties of Logical Operators in English*. Bloomington, IN: Indiana University Linguistics Club.
- Karttunen, Lauri. and Stanley Peters. 1979. ‘Conventional Implicature’, In Oh, Choon-Kyu.

- and David, A. Dinneen. (eds.), *Syntax and Semantics. Vol 11 Presupposition*, 1-56. New York: Academic Press.
- Kay, Paul. 1990. 'Even', *Linguistics and Philosophy* **13**: 59-111.
- Lahiri, Utpal. 1998. 'Focus and Negative Polarity in Hindi', *Natural Language Semantics* **6**: 57-123.
- Lee, Young-Suk, and Laurence Horn. 1994. 'Any as Indefinite Plus Even'. Ms., Yale University.
- Mano, Miho. 2005. 'Ruibetusi 'ko' to 'tu' no nintiteki koosatu' (cognitive approach to numeral classifiers, 'ko' and 'tu'), In Y. Nishimitu and S. Muzugichi (eds.), *Ruibetusi no taisyo* (Contrastive Analyses of Classifiers), 129-148. Tokyo: Kuroshio Publisher.
- Nabeshima, Kojiro. 2003. 'Hitotu V nai koobun ni tuite: nihongo ni okeru kobun bun poo no itirei to site' (On the "...hitotu V nai" construction: as one of the example of the Construction Grammar approach), *Nihongo bunpo gakkai dai 4kaitaikai happyo ronbun syuu* (Proceedings of the Fourth Conference of the Society of Japanese Grammar), 83-92.
- Nakanishi, Kimiko. 2006. 'The Semantics of EVEN and Negative Polarity Items in Japanese, In Donald Baumer, David Montero, and Michael Scanlon (eds.), *Proceedings of the 25th West Coast Conference on Formal Linguistics*. Somerville, MA: Cascadilla Proceedings Project.
- Nakanishi, Kimiko. 2007. 'Cross-linguistic Variation in Polarity Items', Paper presented at the 81<sup>st</sup> Annual Meeting of the Linguistic Society of America. Anaheim, CA.
- Noda, Hisashi. 1995. 'Bun no kaisoo koozoo kara mita syudai to toritate' (Theme and Toritate: Viewed from hierarchic structure of sentence), In Takashi, Masuoka, Hisashi Noda, and Yoshiko Numata (eds.), *Nihongo no syudai to toritate* (Theme and Toritate in Japanese), 1-35. Tokyo: Kuroshio Publisher.
- Numata Yoshiko. 2000. 'Toritate', In Kinsui Satoshi, Kudo Mayumi, and Numata Yoshiko (eds.) *Toki, Hitei to Toritate* (Time, Negation, and Toritate), 153-216. Toyko: Iwanami Syoten.

- Rullmann, Hotze. 2006. 'Does Even Even HAVE Scope?', Handout of the Linguistics Colloquium at the University of Chicago.
- Sakamoto, Tomoka. 2002. 'Suryosi 'hitotu' no imi to yoho; 'N hitotu V nai' koobun o tyusin ni' (Meaning and use of numeral quantifier hito-tu: focussing on the 'N hitotu V nai' construction), *Conference Handbook of the 124th General Meeting of Linguistic Society of Japan*, 30-35.
- Sawada, Osamu. To appear. 'The Multi-functionality of English and Japanese Scalar Distance Constructions: A Semantic Map Approach', *Papers from the 40<sup>th</sup> Annual Meeting of the Chicago Linguistic Society*.
- Sawada, Osamu. In Press. 'From Classifier Construction to Scalar Construction: The Case of the Japanese 'N Hitotu V Nai' and 'N 1-Classifier V Nai' Constructions', In Naomi MacGloin and Junko Mori (eds.), *Japanese/Korean Linguistics 15*. Stanford: CSLI Publication.
- Yoshimura, Keiko. To appear. 'Scope Theory vs. Polarity Theory: Analysis of Japanese Focus Particle -Sae', *Papers from the 40<sup>th</sup> annual meeting of the Chicago Linguistic Society*.

Osamu Sawada, University of Chicago, sawadao@uchicago.edu

# Epistemic Restrictions on Free Choice

## *Herhangi bir* in Turkish\*

Nilüfer Gültekin Şener

University of Connecticut

### 1. Introduction

This paper argues that the Free Choice (henceforth: FC) item *herhangi bir*, the Turkish counterpart of FC *any* in English, is subject to epistemic restrictions. Evidentiality encoded in the tense/aspectual projection is responsible for this restriction. The attested interaction of FC *herhangi bir* and evidentiality is accounted for under an analysis that incorporates the view of FC *any* as universal quantification over possible individuals (*a la* Dayal 1998) and evidential markers as operators (*a la* Izvorski 1997).

It has been observed since Le Grand (1975) that FC *any* in English can occur in episodic statements only if it is modified by a relative clause. Consider the examples below:

(1)

John can sing any song.

(2)

\*Yesterday, John talked to anybody.

(2')

Yesterday, John talked to anybody who came up to him.

The sentence in (1) illustrates one of the natural environments for the occurrence of FC *any*, namely modal contexts. The sentence in (2) is an illustration of the ungrammaticality of FC *any* in an episodic context. The sentence in (2') however, shows that in the presence of a modification by a relative clause, the sentence with an FC *any* in it results in grammaticality.

Turkish encodes episodicity via two distinct morphological items; namely the morphemes [-mİş] and [-DI].<sup>1</sup> Both [-mİş] and [-DI] are suffixal elements that attach to verbs and yield episodic statements in Turkish.<sup>2</sup> Consider the examples below:

(3)  
Herhangi bir çocuk resim yap-abil-ir.  
any child-nom picture draw-can-pres.  
*Any child can draw a picture.*

(4)  
\*Herhangi bir grup konser ver-di.  
any band-nom concert give-[ep./dir.ev.]-3<sup>rd</sup> sg  
*(Speaker witnessed): Any band gave a concert.*

(5)  
\*Herhangi bir grup konser ver-miş.  
Any band-nom concert give-[ep./ind.ev.]-3<sup>rd</sup> sg  
*(Speaker inferred/was reported): Any band gave a concert.*

The sentences in (4) and (5) show that in parallel to the behavior of FC *any* in English, FC *herhangi bir* in Turkish is not grammatical in episodic environments. As noted above modification by a relative clause salvages a sentence with a FC *any* in it in English. However, the same result cannot be maintained in each variant of the episodic statements in Turkish:

(6)  
\*Istanbul-a gid-en herhangi bir grup konser ver-di.  
Istanbul-dat go-rel any band-nom concert give-[ep./dir. ev.]-3<sup>rd</sup> sg  
*(Speaker witnessed); Any band that went to Istanbul gave a concert.*

(7)  
Istanbul-a gid-en herhangi bir grup konser ver-miş.  
Istanbul-dat go-rel. any band-nom concert give-[ep./ind.ev.]-3<sup>rd</sup> sg  
*(Speaker inferred/was reported): Any band that went to Istanbul gave a concert.*

In episodic statements formed with the morpheme [-mİş] as in (7), the behavior of FC *herhangi bir* parallels the behavior of FC *any* in English (i.e. modification by a relative clause helps to save the sentence with a *herhangi bir* phrase in it). In sentence (6) however, where the episodicity of the statement is encoded via the morpheme [-DI], grammaticality is not obtained even in the presence of a relative clause. The ungrammaticality of (6) coupled with the grammaticality of (2') and (7) creates a puzzle. The question is; why is there such a discrepancy in episodic environments if both the morphemes [-mİş] and [-DI] encode episodicity in Turkish? In other words, why does modification by a relative clause save the episodic sentence in (7) from ungrammaticality but not in (6)? I will claim in this paper that modification by a relative clause is a necessary condition for the occurrence of FC *herhangi bir* phrases in episodic statements in Turkish. Meeting this condition is not enough however, as evidentials reveal the *vagueness* requirement on FC *herhangi bir* phrases.

## 2. Background

Dayal (1998) suggests that FC *any* is a universal quantifier that quantifies over possibilities. It universally binds the free situation and individual variables in its scope and rather than yielding a statement about a particular set of individuals, it yields a statement about all possible individuals with the relevant kind. By assuming the theory of possible worlds and trans-world identity (Lewis 1979), evaluation of truth situations (Kratzer 1989) and analysis of nouns as indexicals (Enç 1986), she argues for the following semantics for statements with FC *any*:

(8)  
Any owl hunts mice.

$$\forall s, x [\text{owl}(x, s) \ \& \ C(s)] \ [ \text{GEN } s' [s < s' \ \& \ C'(s')] \ \exists y [\text{mice}(y, s') \ \& \ \text{hunt}(x, y, s')] ]$$

FC *any* creates a tripartite structure. Its restriction is provided by the noun in its syntactic scope. Its nuclear scope is determined by the matrix predicate. FC *any* quantifies over possible individuals by binding the situation and individual indices on the common noun. This noun and the matrix predicate are indexed with a distinct situation variable. FC *any* universally binds the free situation variable in its scope. In turn, it is asserted by the nucleus that these situations extend into situations that verify the matrix predicate. If the matrix predicate has a generic interpretation, the nuclear scope will also have a tripartite structure. Hence an FC *any* phrase always results in a layered structure.

Now, consider the semantics for the sentences in (2) and (2') repeated as (9) and (9') under Dayal's analysis:

(9)  
\*Yesterday John talked to any woman.

$$\forall s, x [\text{woman}(x, s) \ \& \ C(s)] \ \exists s' [s < s' \ \& \ \text{yesterday}(s') \ \& \ \text{talk}(j, x, s')]$$

Under the proposed semantics, the sentence in (9) is ruled out as follows: Recall that the common noun is indexed with a situation variable distinct from the situation variable that is on the matrix predicate. In (9) FC *any* universally binds the free variables in its scope. The nuclear scope introduces a bound time interval that results in a restricted set of situations and individuals. An incompatibility arises between the quantificational domain of FC *any* that is too wide and the matrix predicate that is too narrow. For instance, the women who did not exist yesterday cannot verify the nuclear scope.

In (9') the relative clause restricts the set of situations and individuals quantified over and makes it compatible with the episodicity of the matrix predicate.



(9')

Yesterday John talked to any woman he saw.

$$\forall s, x [\text{woman}(x, s) \ \& \ C(s) \ \& \ \exists s'' [s < s'' \ \& \ \text{yesterday}(s'')] \ \& \ \text{see}(j, x, s'')] ]$$

$$\exists s' [s < s' \ \& \ \text{yesterday}(s') \ \& \ \text{talk}(j, x, s')] ]$$

Assuming that the relative clause has such a function, we expect it to create the same effect in episodic environments in Turkish. In other words, we expect grammaticality both in sentences (6) and (7) as the relative clause restricts the situations quantified over. As the grammaticality of only (6) but not (7) is obtained via modification by a relative clause, the problem then possibly has to do with the properties of the statements formed by the morphemes [-mİş] and [-DI] and their interaction with FC *herhangi bir*. Before laying out the properties of these episodicity markers, let us consider other properties of FC *any* phrases discussed in the literature that might bear on our discussion of the puzzle at hand. It has been noted in Dayal (1998) that FC *any* phrases are subject to what she calls the *vagueness requirement*. Examine the examples from Dayal (1998) below:

(10)

- a. You may pick any flower.
- b. \*You must pick any flower.

(11)

- a. You must pick any flower you see.
- b. \*You must pick any flower in this bed.

The sentences in (10a) and (10b) illustrate a distinction between the grammatical use of FC *any* under permission and commands in English.<sup>3</sup> Lewis (1973) suggests that permissions involve at least one permissible world where the content of the permission holds. Commands however, eliminate the worlds in which it does not hold. For Dayal (1998) permissions lift up the prohibition against the content of the permission, hence in the case of (10a), FC *any* is compatible with the permission as the speaker lifts up the prohibition against all possible flowers. In (10b) the command requires the hearer to pick every possible flower. The fact that there are many flower situations that cannot be extended to situations in which the hearer picks the flower yields ungrammaticality, because the command cannot be fulfilled. This ungrammaticality however, is salvaged via modification by a relative clause as the grammaticality of (11a) indicates. The sentence in (11b) on the other hand shows that determining the set of quantification contextually is a relevant notion in the evaluation of FC *any* phrases. The set of flowers to be picked are not contextually determined in (11a) whereas in (11b), the command is about a contextually determined set. Taking these examples as a starting point, Dayal (1998) suggests that FC *any* is *domain vague*. In other words, it requires the set in its domain to be not known to the speaker. In her account the sentence in (11b) is ruled out as a violation of the *vagueness* requirement. I claim in

this paper that the *vagueness* requirement on FC *any* can be shown to play a certain role in the interpretation of FC *herhangi bir* phrases in Turkish and suggest that the *vagueness* requirement on FC *herhangi bir* clearly manifests itself in evidential statements as these statements create facilitating environments for this restriction. In order to show this interaction, let us consider the category of evidentiality more precisely.

Evidentiality is a linguistic category that encodes speaker-oriented qualifications of propositions. This encoding is achieved in two dimensions: (i) in terms of the evidence that the proposition is based on (It can be DIRECT (visual evidence/auditory evidence, etc.) or INDIRECT (report or inference from the context)) and (ii) with respect to the speaker's commitment to the truth of the proposition (such as (dis)belief/agnosticism) (cf. Chafe and Nichols 1986 for discussion and case studies) cited in Izvorski (1997).

The suffix [-mİş] encodes indirect evidentiality, whereas the suffix [-DI] encodes direct evidentiality in Turkish. Consider the following context where one of the functional uses of indirect evidentiality is illustrated for Turkish:

*Context for [-mİş]*

Bengü cooked an exotic dish for her friend's get together party. She used her new cookbook that has many recipes from world cuisine. She took the dish with her and left home for the party. Her husband and his brother came home and saw the cookbook on the kitchen counter and figured out that the dishwasher was full, etc. Seeing the leftovers, Bengü's husband tells his brother:

(12)  
 Bengü yemek yap-mış. <sup>4</sup>  
 Bengü food do-[ep./ind. ev.]-3<sup>rd</sup> sg  
 (Speaker inferred): Bengü cooked.

The use of (12) indicates that after seeing the cookbook on the counter and the dishes in the dishwasher, Bengü's husband inferred Bengü's cooking. Notice that Bengü's husband himself did not witness the cooking. The event of cooking must have taken place some time in the past unknown to the speaker. It may be early in the morning in this case, but it may as well be a day or a week ago depending on the context. In other words, speaker prefers the use of indirect evidential marker [-mİş] to complete his statement about an event that occurred some time before now that he has not witnessed.

The indirect evidential morpheme [-mİş] is also used for conveying information on events that a speaker is reported about. For instance, the sentence in (12) is also appropriate in a context where the speaker (Bengü's husband in this case) is reported by Bengü's mother that Bengü cooked while her husband was in a business trip. Hearing from Bengü's mother that she cooked, Bengü's husband can utter precisely the same sentence in (12) to report it to his friends at work. In other words, this use of the indirect

evidential marker [-mİş] indicates that the speaker was not part of the context of the event, he did not witness the cooking that took place some time in the past. He was only reported about it.

Now, let us consider the functional use of the episodic marker [-DI]:

*Context for [-DI]*

Bengü's husband asked Bengü to cook some exotic dish and show him the steps of her cooking. She cooked her favorite dish from the cookbook while her husband was taking notes of the steps of her cooking. Next day, Bengü's husband wants to tell their friend that Bengü cooked. He uses the following sentence for conveying this information:

(14)

Bengü yemek yap-tı.

Bengü food do- [ep./dir.ev.]-3<sup>rd</sup> sg

(*Speaker witnessed*): Bengü cooked.

As the contexts for [-mİş] and [-DI] suggest, speakers appeal to an epistemic background in their episodic statements in Turkish. The episodic-indirect evidential marker [-mİş] is used if (i) the speaker infers the event (that took place some time before now) from the context or if (ii) the speaker is reported an event (that took place some time before now). The episodic-direct evidential marker [-DI] is used if the speaker was part of the context of the event (that took place some time before now). Considering the properties of these distinct ways of encoding episodicity in Turkish, I would like to suggest that the epistemic background is responsible for the discrepancy between (6) and (7). I will argue that the reason why the presence of a relative clause cannot yield grammaticality in (6) unlike in (7) is that evidentiality encoded in the tense/aspectual projection blocks the licensing of FC *herhangi bir*. This is due to FC *herhangi bir* being *domain vague* (cf. Dayal (1998)). The relative clause functions the way it is suggested in Dayal (1998), however direct evidentiality is incompatible with the *vagueness* requirement on FC *herhangi bir*. In other words, the use of FC *herhangi bir* is epistemically restricted.

### 3. The proposal

Izvorksi (1997) suggests that indirect evidential marked statements (i) induce a presupposition that the speaker has indirect evidence for *p* and asserts that (ii) *p* is in view of speaker's knowledge state. She assumes Kratzer's modal interpretation analysis for implementing her proposal. Kratzer (1991) claims that interpretation of a modal is relative to conversational backgrounds such as a modal base and an ordering source. She suggests that a proposition is evaluated with respect to these conversational backgrounds. In the case of evidentials, Izvorski (1997) interprets the modal base as *what the speaker knows* and the ordering source

as *speaker has indirect evidence for p*. Consider the interpretation of (15) under Izvorski's account:

(15)  
Az sâm dosal  
I be-1SG.PRES come-P.PART  
*I apparently came.*

(Izvorski 1997)

Interpretation of an Indirect Evidential Proposition:

Presupposition: *Speaker has indirect evidence for p*.  
Assertion: *p is in view of the speaker's knowledge state*.

For Izvorski (1997), indirect evidential is semantically an epistemic modal operator. She argues that the indirect evidential meaning is presupposed and the modal meaning of indirect evidential is asserted. I will assume in line with Izvorski (1997) that the episodic-evidential morpheme [-mIş] introduces an epistemic modal operator and that it asserts that *p* is in view of speaker's knowledge state and that the presupposition that comes with the indirect evidentials is that speaker has indirect evidence for *p*. Furthermore, I claim that direct evidentials can be accounted for in this vein and that a direct evidential marked proposition asserts that *p* is in view of speaker's knowledge state. The presupposition induced is that speaker has direct evidence for *p*.

Assuming Dayal (1998), I suggest that FC *herhangi bir* is a quasi-universal quantifier that results in a tripartite structure.<sup>5</sup> Relative clause provides the compatibility between the situation index on the common noun and the matrix predicate by restricting the set of situations quantified over. Thus the interpretation of FC *herhangi bir* in indirect evidential environments proceeds as follows:

Note that IEV stands for *Indirect Evidential Operator* which is introduced by the episodic morphology, namely the morpheme [-mIş].

(16)  
Istanbul-a gid-en herhangi bir grup konser ver-miş.  
Istanbul-dat go-rel. any band-nom concert give-[ep./ind.ev.]-3<sup>rd</sup> sg  
(*Speaker inferred or was reported*): *Any band that went to Istanbul gave a concert.*

- (i) presupposition: speaker has an indirect evidence for *p*.
- (ii) assertion: *p* is in view of speaker's knowledge state.
- (iii) *Herhangi bir* is a quasi-universal quantifier that creates a tripartite structure. It quantifies over individuals by binding the situation index on the common noun.

IEV [ $\lambda w. \forall_{s,x} [s \leq w \ \& \ \text{band}(x,s) \ \& \ C(s) \ \& \ \exists s' [s < s' \ \& \ \text{past}(s')] \ \& \ \text{go}(Ist.,x,s')]] \ \exists s'' [s < s'' \ \& \ \text{Past}(s'') \ \& \ \text{give}(c,x,s'')]]$ ]

Consider now the interpretation of (12') repeated in (17): Note that DEV stands for *Direct Evidential Operator* that is introduced by the episodic-evidential morpheme [-DI].

(17)

\*Istanbul'a gid-en herhangi bir grup konser ver-di.  
 Istanbul-dat go-rel. any band-nom concert give-[ep./dir. ev.]-3<sup>rd</sup> sg  
 (Speaker witnessed); Any band that went to Istanbul gave a concert.

- (i) presupposition: speaker has a direct evidence for  $p$ .
- (ii) assertion:  $p$  in view of speaker's knowledge state
- (iii) *Herhangi bir* is a quasi-universal quantifier that creates a tripartite structure. It quantifies over individuals by binding the situation index on the common noun.

DEV [ $\lambda w. \forall_{s,x} [s \leq w \ \& \ \text{band}(x,s) \ \& \ C(s) \ \& \ \exists s' [s < s' \ \& \ \text{past}(s') \ \& \ \text{go}(\text{Ist},x,s')]] \ \exists s'' [s < s'' \ \& \ \text{Past}(s'') \ \& \ \text{give}(c,x,s'')]]$ ]

By the direct evidential morphology on the verb, namely [-DI], DEV is introduced in sentence (17). DEV takes a proposition and gives back a truth value. The presupposition that DEV induces is that speaker has direct evidence for  $p$ . Recall that FC *herhangi bir* in Turkish requires *domain vagueness* just like FC *any* in English. The sentence in (17) is ruled out due to a violation of the *vagueness* requirement on FC *herhangi bir*, which was guaranteed by the presupposition induced by the indirect evidential operator in (16). I suggest that indirect evidence is compatible with the speaker's not being acquainted with the members of the domain, whereas direct evidence is at odds with it.

#### 4. Conclusion

Treating FC *herhangi bir* as a quasi-universal quantifier over possibilities makes it possible to account for the role of modification by a relative clause in the episodic environments in Turkish. Modification by a relative clause is necessary for the occurrence of FC *herhangi bir* phrases in evidential marked episodic environments, however the compatibility with the particular evidential marker is also essential as the *vagueness* requirement on FC *herhangi bir* manifests itself in these environments.

---

#### Notes

\* I would like to thank Jon Gajewski, William Snyder, Serkan Şener and especially Yael Sharvit for helpful discussions and comments.

<sup>1</sup> I use the forms [-mİş] and [-DI] to indicate the phonological alternations on these morphemes.

<sup>2</sup> The morpheme [-mİş] is observed to carry various functions in Turkish. In this paper, I will only be concerned with the cases where [-mİş] is interpreted as episodic as well as indirect evidential.

<sup>3</sup> Note that the distinction between the uses of FC *any* in command and permission environments do not arise in deontic necessity cases. FC *any* can freely occur in deontic necessity environments as shown below:

---

(i) Any student must work hard. (Dayal 1998:6a)

<sup>4</sup> I use, *speaker inferred or was reported* as to roughly illustrate the contribution of the meaning conveyed by the indirect evidential marker [-mİş], in addition to the episodic information it encodes. Note that sometimes context favors one use over another, that is to say *report* interpretation may be forced rather than the *inference* interpretation in some cases or vice versa. If there is no such contextual restriction both interpretations come for free. Throughout the text, in such cases where the contextual restriction is available, I indicate only the relevant reading in the translation, otherwise I indicate both potential interpretive contributions. Similarly, I use *speaker witnessed* for illustrating the interpretative contribution of the direct evidential morpheme [-DI] which also encodes episodic information in Turkish.

<sup>5</sup> Eroğlu (1997) analyzes FC *herhangi bir* as a variable that must be bound by the closest potential variable binding operator. She specifically discusses FC *herhangi bir* phrases in the object position. I however, discuss *herhangi bir* in the subject position.

### References

- Dayal, V. 1998. "Any as inherently modal", *Linguistics and Philosophy*, **21**: 433- 476.
- Enç, M. 1986. *Tense Without Scope: An Analysis of Nouns as Indexicals*. Ph.D. Dissertation, University of Southern California.
- Eroğlu, L. 1997. *Indefinite Noun Phrases in Turkish*. Ph.D.Dissertation. University of Wisconsin.
- Izvorski, R. 1997. "The Present Perfect as an Epistemic Modal", *SALT 7*.
- Kratzer, A. 1989. "An Investigation of the Lumps of Thought", *Linguistics and Philosophy* **12**: 607-653.
- Kratzer, A. 1991. "Modality", In Stechow and Wunderlich (eds.) *Semantics: An Interdisciplinary Handbook of Contemporary Research*, Berlin: de Gruyter.
- Le Grand, J. 1975. *Or and Any: The Syntax and Semantics of Two Logical Operators*. Ph.D. Dissertation, University of Chicago.
- Lewis, D. 1979. "A Problem About Permission", in E. Saarinen, R.Hilpinen, I. Niiniluoto and M. Provence Hintikka (eds.) *Essays in Honour of Jaako Hintikka*, Reidel, Dodrecht.

Nilüfer Gültekin Şener  
University of Connecticut  
Department of Linguistics  
Mansfield Road, Storrs,  
CT 06269-1145, USA  
nilufer.sener@uconn.edu

# Cyclic NCI Movement\*

Serkan Şener

University Connecticut

## 1. Introduction

This paper provides evidence for the general claim that successive cyclic movement does not terminate in an intermediate position in overt syntax (cf. Rizzi 2006, Bošković 2006, a.o.). It specifically shows that an active Goal moving successive cyclically may be forced to end its movement in a *cyclic* Spec position under certain circumstances leading the derivation to crash, although Agree with a sufficiently local Probe from this intermediate position is an available option. The empirical facts that underlie the theoretical conclusions come from *Negative Concord Item* (NCI) licensing in Turkish.

This paper is organized as follows: Section 2 lays out the facts and generalizations to be addressed in the paper. Section 3 presents the proposal and tests further predictions of the proposed analysis. Section 4 concludes the paper.

## 2. Empirical Facts and Generalizations

The major facts to be addressed in this paper concern negative XPs and their licensing conditions in non-local syntactic contexts. Prior to a presentation of these facts, however, a brief excursus on negative XPs and their general behavior in Turkish will be presented.

Negative XPs in Turkish display the properties listed in (1). The data that substantiate the listed observations in (1) are given in (2)-(6), respectively:<sup>1</sup>

(1)

- |  |     |
|--|-----|
| a. Used as an elliptical answer to a question: | yes |
| b. Used in non-negative contexts:              | yes |
| c. Used in the subject position:               | yes |
| d. Modified by ‘almost’:                       | yes |
| e. Clause bounded:                             | yes |

(2)

Q: Kim gel-di?  
 who<sub>NOM</sub> come<sub>PAST-3SG</sub>.  
 ‘Who came?’  
 A: Kimse.  
 anybody<sub>NOM</sub>

(3)

Kimse gel-di mi?  
 anybody<sub>NOM</sub> come<sub>PAST-3SG</sub>. Q  
 ‘Did anybody come?’

(4)

Kimse gel-me-di.  
 anybody<sub>NOM</sub> come<sub>NEG-PAST-3SG</sub>.  
 ‘\*Anybody didn’t come.’ (Lit: Nobody came.)

(5)

*Neredeyse* kimse gel-me-di.  
 almost anybody<sub>NOM</sub> come<sub>NEG-PAST-3SG</sub>  
 ‘Almost anybody didn’t come.’ (Lit: Almost nobody came.)

(6)

\*Cem [Pelin-in *kimse-yi* gör-düğ-ün-ü] bil-mi-yor.  
 Cem<sub>NOM</sub> P<sub>GEN</sub> anybody<sub>ACC</sub> see<sub>NOML-3SG.POSS-ACC</sub> know<sub>NEG-PRES</sub>  
 ‘Cem doesn’t know that Pelin saw anybody.’

I assume following the discussion in Watanabe (2004) that the facts illustrated in (2)-(6) (with the exception of (3)) point to the conclusion that negative XPs in Turkish are NCIs.<sup>2</sup> Keeping this in mind, now I turn to facts to be at the center of the investigation in the present paper.

It has already been made clear that a NCI inside a subordinate clause cannot be licensed by matrix negation in Turkish as indicated by the ungrammaticality of (6). The same holds for *sika*-NPs in Japanese as has been noted in Saito (2006):

(7)

?\*Hanako-ga [<sub>CP</sub> nimotu-ga Tookyoo-kara-sika todok-ana-katta to]  
 Hanako<sub>NOM</sub> luggage<sub>NOM</sub> Tokyo<sub>FROM-SIKA</sub> arrive<sub>PAST</sub> that  
 Ziroo-ni iw-ana-katta (koto)  
 Ziroo<sub>DAT</sub> say<sub>NOT-PAST</sub> fact  
 (Saito 2006, 60b)





The ungrammaticality of (11) suggests that the idea entertained with regard to (6) vs. (9), namely the presence of radical reconstruction with long distance NCI movement, may not be a viable option, for otherwise the copy at the foot of the non-trivial chain formed by the long distance moved NCI in (11) would be active in LF. Assuming that NCI licensing takes place in LF, as before, then technically there would be nothing to prevent licensing of the NCI by the local Neg° once reconstruction takes place (cf. (10)). This clearly yields an undesired situation.

I will argue in the next section that a perspective shift is needed in tackling this puzzle for at least two reasons: First, the argumentation above does not quite work as has been evident. Second, even if we tried to make it work, an approach along such lines may not be readily translated into a theory of syntax as developed in Chomsky (2001), which I adopt in this paper in its essentials.

### 3. Forced (Non-)Criterial Freezing and *Agree-In-Passing*

I begin with a brief discussion of Watanabe (2004) for its relevance to NCI-licensing in Turkish.

Following Watanabe (2004), I argue that the negative concord reading in sentences such as (4), repeated here as (12), arises as a result of an Agree relation of the NCI with its local Neg°:

(12)  
 Kimse            gel-me-di.  
 anybody<sub>NOM</sub> come<sub>NEG-PAST-3SG</sub>  
 ‘Nobody came.’

Watanabe (2004) suggests that the negative concord reading (as opposed to *negative doubling*) in Japanese involves the mechanism of *feature copying*, which is first proposed in Chomsky (1995) but abandoned in later work. Two additional assumptions play an important role in Watanabe’s (2004) analysis: (i) Neg° has *interpretable* [neg]-features (*ineg*), and (ii) the feature that renders the NCI active is its *uninterpretable* [focus]-feature (*ufoc*), which may not invoke focus semantics (cf. Giannakidou 2000). Watanabe’s (2004) analysis diverges from Chomsky (2001) with respect to how the operation *Agree* is implemented. As noted in (i) above, Watanabe assumes that Neg° (=Probe) has *ineg* (see Watanabe 2004 for the justification of this assumption), and the trigger for Agree is the *ufoc* feature of the NCI (=Goal), whereas in Chomsky’s (2001) system Agree requires both Probe and Goal to have *uFs* to render them active. Details aside, Watanabe (2004) argues that the negative concord reading ensues when Neg° comes to bear two [neg]-features, one of which is its own Probe feature while the other one is copied onto it as a result of Agree with the Goal (i.e., *ineg* of NCI), and the *ufoc* of NCI is deleted as a result of Agree. Crucially,

the two [neg] features on Neg° cancel each other out to be interpreted as the same thing as affirmation, yielding the negative concord reading. The idea is illustrated in (13) graphically:

(13)

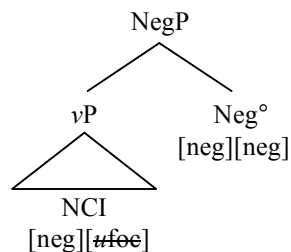

I adopt this approach to account for the licensing of NCIs in Turkish without offering any modifications.

I also assume that the version of *Phase Impenetrability Condition* (PIC) stated in Chomsky (2001) is relevant in explaining the locality of NCI-licensing. The definition of the PIC is given in (14):<sup>4</sup>

(14) *Phase Impenetrability Condition*

The domain of H is not accessible to operations at ZP; only H and its edge are accessible to such operations. [Chomsky 2001, p:14.]

Under the definition in (14), an object NCI, for example, will be accessible to Neg° provided that it remains within the complement domain of Neg° before Spell-Out applies to VP at the C(P)-phase. This readily explains why matrix Neg° cannot license the NCI inside the subordinate clause in (6). Consider the derivation of (6) illustrated in (15) (irrelevant details omitted):

(15)

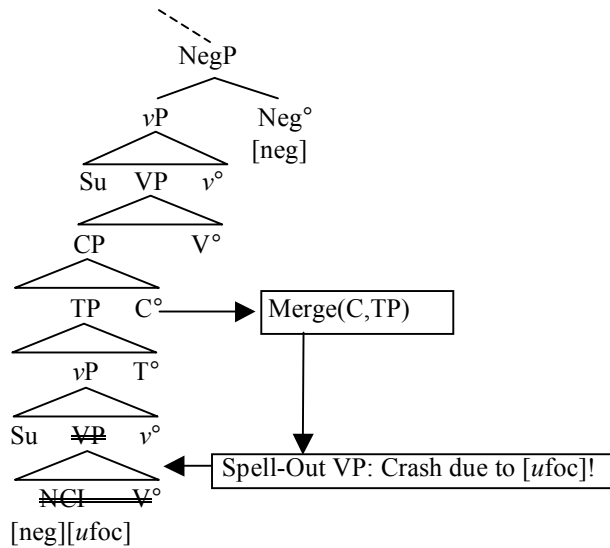

I follow Chomsky (2001) in assuming that the operation Agree is subject to *locality* constraints, which is regulated by the PIC under the theory currently adopted, and hence in this respect it is not different from Move/Re-Merge. In (15), then, the problem is that the introduction of C triggers the Spell-Out of lower VP, which contains the NCI with *ufoc*, and since the *ufoc* feature remains unchecked it leads to a crash in the interfaces.

The theory adopted in this paper predicts the grammaticality of a sentence in which an NCI gets sufficiently local to a Probe once the former sets out to move up.<sup>5</sup> Another but related prediction of the theory is that a category that comes sufficiently local to establish an Agree relation with the Probe must in principle be able to stay in this position if the Probe does not have the (EP)P property. This amounts to the claim that the theory, as it is, predicts that successive cyclic movement may end in an intermediate position, though it is argued to be not a licit option in Bošković (2006), and Rizzi (2006). I suggest that the ungrammaticality of the Turkish sentence in (16), which involves long distance movement of a (non-negative) DP<sub>ACC</sub>, is due to a violation of the ban that rules out successive cyclic movement that stops short (it is assumed in (16) that the subject DP is moved to Spec-T):<sup>6</sup>

(16)

\*[<sub>TP</sub> Cem [<sub>vP</sub> yeni araba-y<sub>1</sub> [<sub>v'</sub> t<sub>Cem</sub> [<sub>VP</sub> Pınar-a [<sub>CP</sub> t<sub>1</sub> Nilüfer-in t<sub>1</sub> gör-düğ-ün-ü] söyle-di]]]].  
 C<sub>NOM</sub> new car<sub>ACC</sub> P<sub>DAT</sub> N<sub>GEN</sub>  
 see<sub>NOML-3SG.POSS-ACC</sub> tell<sub>PAST</sub>

'Cem told Pinar that Nilufer saw the new car.'

In (16), the  $DP_{ACC}$  terminates its long distance movement in an intermediate position, i.e., Spec- $v$ . On the other hand, long distance movement of the  $DP_{ACC}$  to the edge of matrix clause yields a grammatical sentence as in (17):

- (17)  
 (?) $[_{TP}$  Yeni araba- $y_{I_1}$   $[_{TP}$  Cem  $[_{vP}$   $t_1$   $[_{v'}$   $t_{Cem}$   $[_{VP}$  Pınar-a  
 new car $_{ACC}$   $C_{NOM}$   $P_{DAT}$   
 $[_{CP}$   $t_1$  Nilüfer-in  $t_1$  gör-düğ-ün-ü] söyle-di]]]]].  
 $N_{GEN}$  see $_{NOML-3SG.POSS-ACC}$  tell $_{PAST}$   
 ‘Cem told Pinar that Nilufer saw the new car.’

Now, let us turn to NCIs. Witness the ungrammaticality of (18):

- (18)  
 \*Cem  $kimse-yi_1$  öğretmen-e  $[_{CP}$  Pelin-in  $t_1$   
 Cem $_{NOM}$  anybody $_{ACC}$  teacher $_{DAT}$   $P_{GEN}$   
 gör-düğ-ün-ü] söyle-me-di.  
 see $_{NOML-3SG.POSS-ACC}$  tell $_{NEG-PAST}$   
 ‘Cem did not tell the teacher that Pelin saw anybody.’

I suggest that (18) is ungrammatical for the same reason as (16) is ungrammatical: The NCI ends up staying in a *cyclic* Spec position (i.e., it finalizes its cyclic movement in an intermediate position, Spec- $v$ ), and this leads to ungrammaticality regardless of whether Agree(Neg $^{\circ}$ ,NCI) is established. This derivation is sketched graphically in (19) (again, irrelevant details are omitted, so are linear order considerations):

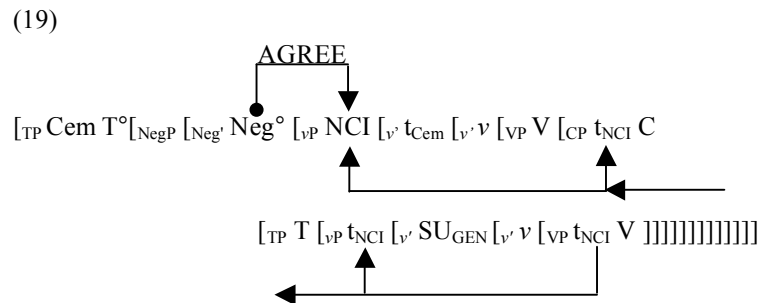

An additional assumption to play a role in the explanation of (18) and others is that the NCI cannot move to Spec-Neg $^{\circ}$  for Neg $^{\circ}$  may never have the (EP)P-property, and as a result the NCI would never finalize its successive cyclic movement in Spec-Neg $^{\circ}$ , or for that matter, in any Spec position. The dilemma that is relevant for the ungrammaticality of (18) is that although the NCI may

move up in the structure and may establish an Agree relation with  $\text{Neg}^\circ$  when two are sufficiently local, the NCI cannot go any further having checked its  $uF$  in this position and thus remains in a *cyclic Spec* position in overt syntax. I depict this situation as one of a *forced non-criterial freezing* elaborating on Rizzi's (2006) system/terminology.<sup>7</sup>

The ungrammaticality of (9), repeated below as (20), can now be addressed:

(20)

\**Kimse-yi*<sub>i</sub> Cem [Pelin-in  $t_i$  gör-düğ-ün-ü] bil-mi-yor.  
 anybody<sub>ACC</sub> Cem<sub>NOM</sub> P<sub>GEN</sub> see<sub>NOML-3SG.POSS-ACC</sub> know<sub>NEG-PRES</sub>  
 'Cem doesn't know that Pelin saw anybody.'

Recall that I have tentatively suggested above that  $\text{Agree}(\text{Neg}^\circ, \text{NCI})$  is an option when the NCI stops by and (inadvertently) stays in *Spec-v*. On the other hand, this has not been evident given the ungrammaticality of the relevant sentences. The suggestion that Agree may be established by a Goal that ultimately gets stuck in an intermediate position makes an interesting prediction: If  $\text{Agree}(\text{Neg}^\circ, \text{NCI})$  is an option in such a situation, then a sentence in which a NCI is embedded within a larger syntactic object containing another category that also has to check a feature for itself (forcing movement out of the intermediate position) must be well-formed.

Suppose that the NCI is contained in a larger DP that also contains a D-linked *wh*-phrase with a *topic* feature (cf. Pesetsky 1987, Grohmann 2001, a.o.). The relevant example is in (22):

(21)

?[<sub>DP</sub> [<sub>DP</sub> *pro hangi* arkadaş-ı-nın [<sub>D'</sub> *hiçbir* kitab-ı-nı]]]<sub>i</sub>  
 which friend<sub>3.sg.POSS-GEN</sub> any book<sub>3.sg.POSS-ACC</sub>  
 Cem [Pelin-in  $t_i$  gör-düğ-ün-ü] bil-mi-yor?  
 C<sub>NOM</sub> P<sub>GEN</sub> see<sub>NOML-3SG.POSS-ACC</sub> know<sub>NEG-PRES</sub>  
 'Any book of which of his friend does Cem not know that Pelin saw?'

(21) is slightly degraded but it is a grammatical sentence, more importantly it displays a clear contrast with (20). As the derivational history of (21) depicted in (22) shows, (21) involves  $\text{Agree}(\text{Neg}^\circ, \text{NCI})$  when the NCI reaches the closest intermediate position to the Probe checking the  $u\text{foc}$  of the NCI, and also  $\text{Agree}(\text{C}^\circ, \text{DP}_{wh})$  which attracts the larger DP to its *Spec* position, as a result of which the DP ends up in a *criterial position*.<sup>8</sup>



## 4. Summary

This short paper provides support essentially from the empirical domain of NCI licensing for (i) the theory of phases and the PIC developed in Chomsky (2001), (ii) successive cyclic movement in the formation of long distance dependencies and *Agree-in-passing*, (iii) the *lack* of successive cyclic movement *that stops short*.

---

## Notes

\* I would like to thank the audience at WECOL 2006 for comments, and Nilüfer Gültekin Şener for her help with the Turkish data.

<sup>1</sup> The results of some of the tests presented here have also been discussed in Keleşir (2001), though it must be noted that Keleşir (2001) concludes on the basis of similar facts presented in (2) that negative XPs in Turkish are N(egative) P(olarity) I(tems) and not N(egative) Q(uantifier)s.

<sup>2</sup> It should first be noted that this choice is not very crucial for the general claims to be made in this paper. As noted in the main text, (3) may be a potential counter-argument to classify negative XPs as NCIs in Turkish, although yes/no questions appear to be the only non-negative context in which negative XPs may be licensed. I will contend here that the test that concerns the usability of negative XPs in yes/no questions is inconclusive due to some other complications that I will not be able to go into in this paper.

<sup>3</sup> I will not make an attempt to explain why Turkish differs from Japanese in the relevant respects. Saito (2005) proposes that the improvement observed in (9) is explained once we assume that *sika*-NPs in Japanese may be base-generated at the edge of their clauses, which make them eligible for licensing by the matrix Neg. This option is not available for Turkish.

<sup>4</sup> Compare the definition of PIC in (14) with the previous version stated in Chomsky (2000):  
*PIC* [Chomsky 2000, p:108.]

The domain of H is not accessible to operations *outside* ZP; only H and its edge are accessible to such operations.

<sup>5</sup> There are at least two potential implementations of movement to a phase edge in cases where a *uF* of an XP otherwise remains unchecked in a domain to undergo Spell-Out: (i) Chomsky's (2001) *Indirectly Feature-Driven Movement* hypothesis, where movement to the edge of a phase is forced by a (EP)P-feature assigned to the phase head (which is determined locally in the computation) if the *uF* of an XP remains unchecked, or (ii) the proposal defended in Bošković (2006), where movement of an XP with *uFs* to the edge of a phase is possible because movement is indeed forced by the *uFs* of XP (under a specific interpretation of *Greed*). Either proposal works here, although they differ quite a bit in details. I refer the reader to these works for details.

<sup>6</sup> A ditransitive matrix predicate is used to mark the left edge of the subordinate clause with an argumental DP (dative). This is because Turkish is a head-final language, and in many circumstances it is not clear on the surface whether a subordinate XP crosses its clausal boundaries.

<sup>7</sup> It is *forced*, because, by assumption, the Probe (i.e., Neg<sup>o</sup>) does not have the (EP)P-property. And, it is *non-criterial* because an intermediate position does not count as a *criterial position* (cf. Rizzi 2006). For Rizzi (2006) movement is *Attract*, and movement into intermediate positions involve checking of *uFs*, where a *uF* in the intermediate position has a corresponding *iF* in the final position (where a criterion is satisfied). Bošković (2006), on the other hand, argues that successive cyclic movement is forced by the *uFs* of XP (cf. fn.5), and an XP as such never ends up in a *cyclic Spec* position for feature checking requires that the *uF* of an XP acts as both as a Goal and a Probe (cf. Epstein et al. 1997, among others). The latter component of the feature checking requires the movement of the XP to the Spec position of the higher category that bears the Probe. Under



Bošković's (2006) proposal, then, the text analysis of the ungrammaticality of (18) will be related to the lack of this secondary component of the feature checking operation (i.e., movement into Spec-Neg<sup>o</sup>). Ultimately, this explains in a different fashion why a category undergoing successive cyclic movement cannot remain in an intermediate position.

<sup>8</sup> One question that remains a mystery is why the *wh*-DP cannot be moved out of the larger DP after Agree(C, *wh*-DP) takes place but it must pied-pipe the NCI. I leave this open for the time being.

<sup>9</sup> It is a well-known observation that negative quantifiers, NPIs, and NCIs resist topicalization across languages.

## References

- Bošković, Ž. 2006. Agree, Phases, and Intervention Effects. Ms. University of Connecticut, Storrs.
- Chomsky, N. 2000. 'Minimalist Inquiries: the Framework', in *Step by Step: Essays on Minimalist Syntax in Honor of Howard Lasnik*, (eds.) R.Martin, D.Michaels, and J.Uriagereka. 89-155. Cambridge, Mass.: The MIT Press.
- Chomsky, N. 2001. Derivation by Phase. In *Ken Hale: A Life in Language*, (ed.) M. Kenstowicz. 1-52. Cambridge, Mass.: The MIT Press.
- Giannakidou, A. 2000. 'Negative . . . concord?' *Natural Language & Linguistic Theory* 18: 457 – 523.
- Grohmann, K.K. 2000. Prolific peripheries: A radical view from the left. Doctoral Dissertation, University of Maryland at College Park.
- Keleşir, M. 2001. Topics in Turkish syntax: Clausal structure and scope. Doctoral Dissertation, MIT, Cambridge: Mass.
- Pesetsky, D. 1987. 'Wh-in situ: Movement and unselective binding', in *The Representation of (In)definiteness*, (eds.) A.G.B. ter Meulen and E.Reuland. 98-129. Cambridge, Mass.: The MIT Press.
- Rizzi, L. 2006. 'On the form of chains: Criterial positions and ECP effects', in *Wh-Movement: Moving On*, (eds.) L.Cheng and N.Corver. 97-133. Cambridge, Mass.: The MIT Press.
- Saito, M. 1989. 'Scrambling as semantically vacuous A'-movement', in *Alternative Conceptions of Phrase Structure*, (eds.) M.Baltin and A.Kroch. Chicago: University of Chicago Press.
- Saito, M. 2005. Further notes on the interpretation of scrambling chains, Ms., Nanzan University and The University of Connecticut, Storrs.
- Tanaka, H. 1997. 'Invisible movement of Sika-Nai and the linear crossing constraint', *Journal of East Asian Linguistics* 6: 143-178.
- Watanabe, A. 2004. 'The genesis of negative concord: Syntax and morphology of negative doubling', *Linguistic Inquiry* 35.4: 559-612.

Serkan Şener  
University of Connecticut,  
Department of Linguistics,  
Storrs, CT 06269-1145, USA  
serkan.sener@uconn.edu

# Derivation of Two V<sup>o</sup> Coordination and its Theoretical Implications\*

Masaaki Takashima  
Michigan State University

## 1. Introduction

Based on the Linear Correspondence Axiom (LCA), Kayne (1994) claims that coordination of verbs is not allowed. This is because if the sentence (1a) is the case of verb, V<sup>o</sup>, coordination as in (1b), there is not asymmetric c-command relationship among the three heads and therefore LCA cannot linearize them.

- (1) a. John criticized and insulted his boss. (Kayne 1994)

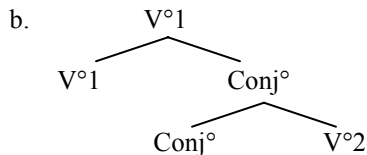

Instead, Kayne (1994) adopts a right-node-raising analysis of V<sup>o</sup> coordination where an internal argument in the first conjunct is deleted under the identity condition with the one in the second conjunct (2a).

- (2) a. John [criticized [e]<sub>i</sub>] and [insulted [his boss]<sub>i</sub>].  
b. John [criticized [his boss]<sub>i</sub>] and [insulted [e]<sub>i</sub>].

The analysis, however, is not without problems. First, as Kayne (1994) admits, it leaves the question why the reverse deletion in (2b) is not possible. Secondly, the analysis offers no clear account for the two properties of V<sup>o</sup> coordination: 1. Strict Adjacency and 2. Constituency, which will be introduced later in this paper. Furthermore, there is empirical evidence suggesting that the coordination of verbs is possible. For example, gapping in (3) indicates that the two verbs and the conjunction without the complements of the verbs form a constituent.

- (3) John criticized and insulted his boss and Karen — her husband.

Another piece of evidence for the coordination of verbs is from a V2 language. In German, coordinated verbs appear in the second position in the clause, strongly indicating that they, as a constituent, raise to the CP head position.

- (4) Im dem Garten kritisierte und beschuldigte Tom seinen Boss (German)  
 In the garden criticized and blamed Tom his boss  
 ‘Tom criticized and blamed his boss in the garden.’

Based on the empirical evidence in favor of the coordination of verbs, this paper investigates the derivation of V° coordination, focusing on English and Japanese.

## 2. V° Coordination

### 2.1 Two types of V° coordination

There are two types of V° coordination. First is the case where the coordinated verbs are different, different V° coordination, as in (5). The other is where the coordinated verbs are the same, same V° coordination, as shown in (6).

- (5) a. John criticized and insulted his boss.  
 b. John-ga sono ronbun-o kopiisi-(and)-fairusi-ta. (Takano 2004)  
 John-Nom that paper-Acc copy-(and)-file-Past  
 ‘John copied and filed that paper.’
- (6) a. Ken hit and hit the wall.  
 b. Ken-ga kabe-o tataki-ni-tatai-ta (Takashima forthcoming)  
 Ken-Nom wall-Acc hit-NI-hit-Past  
 ‘Ken hit and hit the wall.’

One thing to be noted here is that in Japanese a conjunction has different phonetic realizations in the two types of V° coordination. In the different V° coordination, it is phonetically null (Takano 2004), whereas in the same V° coordination, it is phonetically realized as *-ni* (Takashima forthcoming).

### 2.2 Two properties of V° coordination

V° coordination has two syntactic properties, which are demonstrated clearly with the same V° coordination.<sup>1</sup> The first is the strict adjacency, which holds between the verbs and the conjunction. As (7) and (8) show, neither arguments nor adjuncts can intervene the verbs and the conjunction.

- (7) a. \*Ken hit and quickly hit the wall.  
 b. \*Ken hit the wall and hit the wall.

- (8) a. \*Ken-ga kabe-o tataki-ni subayaku tatai-ta  
 Ken-Nom wall-Acc hit-NI quickly hit-Past  
 ‘Ken quickly hit and hit the wall.’  
 b. \*Ken-ga tataki-ni kabe-o tatai-ta  
 Ken-Nom hit-NI wall-Acc hit-Past  
 ‘Ken hit and hit the wall.’

The second property is the constituency between one verb and the conjunction. It differs in the two languages. In English, it is between the second verb and the conjunction, whereas in Japanese, it is between the first verb and the conjunction. The difference reflects the head-parametric difference (head-initial vs. head-final) between the two languages as illustrated in (9).

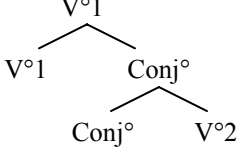
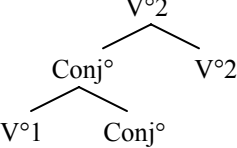
- (9) a.   
 English  
 Head-initial
- b.   
 Japanese  
 Head-final

In Japanese, the claim is backed by the substitution test with *sou*. *Sou* substitutes the verb(s) which form(s) a constituent in the verbal compound as shown in (11). The example is from Japanese verbal compound in (10).

- (10) Ken-ga Tom-o osi-taosi-ta  
 Ken-Nom Tom-Acc push-topple-Past  
 ‘Ken pushed Tom down.’
- (11) a. Ken-ga Tom-o osi-taosi, Jim-mo Bill-o sou taosi-ta  
 Ken-Nom Tom-Acc push-topple, Jim-also Bill-Acc so topple-Past  
 ‘Ken pushed Tom down and Jim toppled Bill in that way, too.  
 (*sou* substitutes 1<sup>st</sup>V)
- b. \*Ken-ga Tom-o osi-taosi, Jim-mo Bill-o osi sou si-ta  
 Ken-Nom Tom-Acc push-topple, Jim-also Bill-Acc push so do-Past  
 ‘Ken pushed Tom down and Jim toppled Bill in that way, too.  
 (*sou* substitutes 2<sup>nd</sup>V)
- c. Ken-ga Tom-o osi-taosi, Jim-mo Bill-o sou si-ta  
 Ken-Nom Tom-Acc push-topple, Jim-also Bill-Acc so do-Past  
 ‘Ken pushed Tom down and Jim did that to Bill, too.  
 (*sou* substitutes both 1<sup>st</sup>V and 2<sup>nd</sup>V)

In V° coordination in Japanese, *sou* can substitute the 1<sup>st</sup>V and the conjunction as in (12a), but cannot substitute the 2<sup>nd</sup>V and the conjunction (12b). However, *sou* can substitute the whole verbal compound as shown in (12c).

- (12) a. Ken-ga kabe-o tataki-ni-tataki, Jim-mo doa-o sou tatai-ta  
 Ken-Nom wall-Acc hit-NI-hit, Jim-also door-Acc so hit-Past  
 ‘Ken hit and hit the wall and Jim hit the door in the same way.’  
 (*sou* substitutes 1<sup>st</sup>V and the conjunction)
- b. \*Ken-ga kabe-o tataki-ni-tataki, Jim-mo doa-o tataki sou si-ta  
 Ken-Nom wall-Acc hit-NI-hit, Jim-also door-Acc hit so do-Past  
 ‘Ken hit and hit the wall and Jim hit the door in the same way.’  
 (*sou* substitutes 2<sup>nd</sup>V and the conjunction)
- c. Ken-ga kabe-o tataki-ni-tataki, Jim-mo doa-o sou si-ta  
 Ken-Nom wall-Acc hit-NI-hit, Jim-also door-Acc so do-Past  
 ‘Ken hit and hit the wall and Jim did so to the door.’  
 (*sou* substitutes 1<sup>st</sup>V, 2<sup>nd</sup>V and the conjunction)

The above data shows that there are two constituents in the V° coordination in Japanese: 1. the 1<sup>st</sup>V and the conjunction, 2. the 1<sup>st</sup>V, the 2<sup>nd</sup>V, and the conjunction. This supports the structure of V° coordination in Japanese in (9b).

### 3. Theoretical Background

#### 3.1 Serial verb constructions and verbal compounds

In this paper, I assume the following definition of Serial Verb Constructions (SVCs) adapted from Collins (1997).

- (13) *Serial Verb Constructions (SVC)*  
 A serial verb construction is a succession of verbs and their complements (if any) with one subject and one tense value that are not separated by any overt marker of coordination or subordination  
 (Collins 1997)

The above definition covers the sentence like (14) where the object intervenes the verbs.

- (14) Me nya devi-e dzo (Ewe, Collins (1997))  
 ISG chase child-DEF leave  
 ‘I chased the child away.’

The definition also covers the verbal compounds as in (15). In this case, the verbs have strict adjacency and the object does not intervene them.<sup>2</sup>

- (15) a. Ya i tc'eon |o'a tsi (≠Hoan, Collins (2002))  
 3SG PAST make absent 3PL  
 'He finished making them'
- b. Ken-ga Tom-o osi-taosi-ta (Japanese)  
 Ken-Nom Tom-Acc push-topple-Past  
 'Ken pushed Tom down.'

As is noted by Nishiyama (1998) and Collins (2002), among others, there is a parallelism between SVCs and verbal compounds. First, as described in (13), in both constructions there is a succession of verbs which share one overt subject and object (if any) and a tense value. Secondly, in both constructions the linear order of the verbs has to reflect the actual order of the events denoted by the verbs (Kageyama 1993, among others). In other words, it is prohibited to switch the linear order of the two verbs in the sentences in (14) and (15).

### 3.2 Multiple verb movement in Collins (2002)

Besides the general parallelism we have just seen, there are more similarities between SVCs and verbal compounds across some languages. Collins (2002) notes that SVCs in Ewe and verbal compounds in ≠Hoan express the same range of meanings such as directional, consecutive and benefactive. Moreover, in most cases the same verbs are used in the two constructions. Based on the parallelism, Collins (2002) derives the verbal compounds in ≠Hoan by multiple verb movement from underlying structure similar to SVCs. To be more concrete, he claims that the functional head, the light verb  $\nu$  with [+multiple] motivates the multiple verb movement in the way that follows the two types of locality conditions: 1. Minimal Link Condition (MLC) (Chomsky 1995) and Local Move (Chomsky 2000). (16) illustrates this.

- (16) a. [ $\nu$   $\nu$  [ $_{VP1}$  V1 [ $_{VP2}$  V2]]] (underlying form)  
 b. [ $\nu$  V1- $\nu$  [ $_{VP1}$   $t_{v1}$  [ $_{VP2}$  V2]]] (Minimal Link Condition)  
 c. [ $\nu$  V1-V2- $\nu$  [ $_{VP1}$   $t_{v1}$  [ $_{VP2}$   $t_{v2}$ ]]] (Local Move)

In the first step (16a), V1 moves to  $\nu$  because of the MLC, since in the underlying VP-shell structure of the SVC, following Collins (1997), V1 is closer to  $\nu$  than V2. In the next step, the Local Move requires "tucking in" (Richards 1997) of V2 to the inner head position (16c).<sup>3</sup> This derivational analysis parallels that of Richards (1997) for multiple movement, such as wh-movements. Collins (2002) assumes that verb movements are always to a functional head, not to a verb and it is always left-adjunction. This assumption is consistent with Kayne's (1994) antisymmetry, whose consequence he claims is in (17), adapted from Collins (2002). (18) illustrates the formation of the verbal compounds based on the assumption. This generates the correct word order of verbs in verbal compounds.

(17) Let X and Y be heads; if X adjoins to Y, then X precedes Y

- (18) a.  $v$                       b.  $\begin{array}{c} v \\ \swarrow \searrow \\ V1 \quad v \end{array}$                       c.  $\begin{array}{c} v \\ \swarrow \searrow \\ V1 \quad v \\ \quad \swarrow \searrow \\ \quad V2 \quad v \end{array}$

#### 4. Derivation of V° coordination

##### 4.1 Parallelism among SVCs, verbal compounds and V° coordination

Following the definition of SVCs in (13), V° coordination cannot be either a SVC or a verbal compound for its overt marker of coordination. However, there is a parallelism among the three constructions, especially between verbal compounds and V° coordination. First, as in SVCs and verbal compounds, in V° coordination in (5) and (6), there is only one overt subject and object (if any) for the coordinated verbs. Secondly, as is mentioned already, in SVCs and verbal compounds the linear order of the verbs has to reflect the actual order of the events. This fact also holds in V° coordination generally.<sup>4</sup> In (19a) and (20a), the order of the two verbs has to correspond to the actual order of the two events. Otherwise the sentences have different meanings as in (19b) and (20b).

- (19) a. John criticized and blamed his boss.  
       b. John blamed and criticized his boss.
- (20) a. John-ga sono ronbun-o kopiisi-(and)-fairusi-ta.  
       John-Nom that paper-Acc copy-(and)-file-Past  
       ‘John copied and filed that paper.’  
       b. John-ga sono ronbun-o fairusi-(and)-kopiisi-ta.  
       John-Nom that paper-Acc file-(and)-copy-Past  
       ‘John filed and copied that paper.’

Thirdly, like verbal compounds but unlike SVCs, V° coordination has the strict adjacency between the verbs and the conjunction and no object intervenes them.

##### 4.2 Derivation of V° coordination

In the above discussion, we saw the similarities among the three constructions. We also observed that V° coordination is more like verbal compounds than SVCs. Furthermore, following Collins (2002), verbal compounds are derived by multiple verb movement from the underlying structure of SVCs. These three facts lead to a hypothesis that V° coordination is also derived from multiple verb

movement from underlying structure of some phrasal coordination. The question that immediately arises here is what is the functional head with [+multiple]? I argue it is Aspect (Asp) head. The analysis makes the structure the same as that independently suggested by Collins (2002) for a consecutive verbal compound (21). He suggests that (21) has the underlying structure of *vP* coordination with *AspP*, from which multiple verb movement takes place to *Asp* with [+multiple].

- (21) Ma qo kí- tsaxo ‘am ||ia’<sup>e</sup> (≠Hoan, Collins (2002))  
 1SG FUT kí[PL] cook eat meat  
 ‘I will cook and eat meat (repeatedly).’

The *AspP* in *V°* coordination finds empirical support from the language like Chinese where the aspect marker has phonetic realization. In Chinese *V°* coordination in (22), the aspect marker, *-le*, can appear only with the 1<sup>st</sup>*V*, not the 2<sup>nd</sup>*V* like \**zou-you-zou-le*, or with both verbs like \**zou-le-you-zou-le*. As we will see below, this is correctly predicted by the line of argument we take. It is so, because assuming *-le* projects *AspP* as a head, Chinese is a head-initial language and the 1<sup>st</sup>*V* raises to *Asp* at first because of MLC before the 2<sup>nd</sup>*V*.

- (22) Zhangsan zou-le-you-zou (Chinese)  
 Zhangsan walk-Asp-and-walk  
 ‘Zhangsan walked and walked.’

The above discussion leads to the derivation of *V°* coordination as in (23).

- (23) a. John criticized and insulted his boss.  
 b.

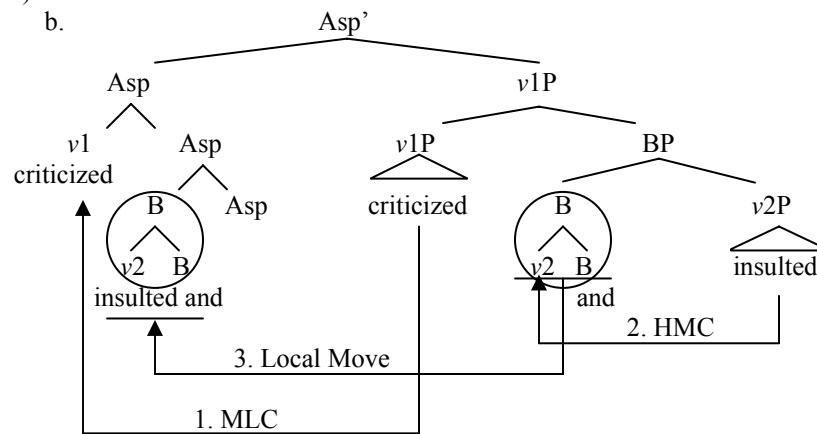

The structure has *vP* coordination with one *Asp* with [+multiple] above it. In the first step, *v1* with *V1* (*V1* is omitted) raise to *Asp* because of the MLC, since *v1*



is closer to Asp than  $v_2$ . In the next step,  $v_2$  with V2 (V2 is omitted) raise to Asp. In this process there is an intervening head between Asp and  $v_2$ , which is the conjunction head Boolean (B).<sup>5</sup> Therefore, following the Head Movement Constraint (HMC) (Travis 1984),  $v_2$  raises to B at first (the circle) and then they together raise to Asp head. The multiple movement in (23b) follows Collins' (2002) assumption that verb movements are always to a functional head, not to a verb and it is always left-adjunction. This is held even when the V2, *insulted*, raises to the conjunction head B, since B is a functional head. Notice, however, the analysis generates the wrong word order of the coordinated verbs, *criticized insulted and*, as opposed to *criticized and insulted*.

Thus, here I depart from Collins (2002) with respect to Kayne's (1994) antisymmetry for linearization of the verbs in the complex head. Instead, I follow Saito and Fukui (1998) for the linearization in the sense that the operation Merge specifies the linear order reflecting the value of the head-parameter. According to them, in the head-initial language, English, elements can be merged only on the right side of a head. On the other hand, in the head-final language, Japanese, elements can be merged only on the left side of a head. This way of Merge (parametrized version of Merge) which follows the value of the head-parameter is costless. The proposal is correlated with the directionality of optional movement. English has an optional movement, heavy NP shift in the rightward upward direction and the element is merged in the right side of a head. On the other hand, Japanese has an optional movement, scrambling in the leftward upward way and the element is merged in the left side of a head. Both of the optional movements follow the parametrized version of Merge and therefore costless. Furthermore, optional movements are not forced for any reason so they do not follow the MLK and Relativized Minimality (RM) (Rizzi 1990). In contrast, the movement in the opposite direction is costly and needs to be forced for some reason and it forms an adjunct structure.

Verb movements are obligatory to functional heads such as  $v$  and Asp and incorporation of Saito and Fukui's (1998) proposal to verb movements have two consequences. First, as for the directionality of movements, in English they are leftward upward direction and in Japanese rightward upward way. Secondly, they have to follow MLC and RM. Moreover, I make two assumptions here. First, the conjunction head has the same feature of the head whose projection it takes as a complement. Concretely, in (23) B takes  $vP$  as a complement whose head is  $v$  so it has the verbal feature. Secondly, the feature in the conjunction head is defective in the sense that the conjunction head itself does not involve in any Agree or Move operation. The parametrized version of movement provides the straightforward account for the linearization of the coordinated verbs. This is shown in (24) and (25) for English and Japanese, respectively.<sup>6</sup>

In both cases, in the first step the higher  $v$  with the higher V (the higher V is omitted) raise to Asp because of the MLC. In the next step, the lower  $v$  with the lower V (the lower V is omitted) raise to Asp.

- (24) a. John criticized and insulted his boss.  
b.

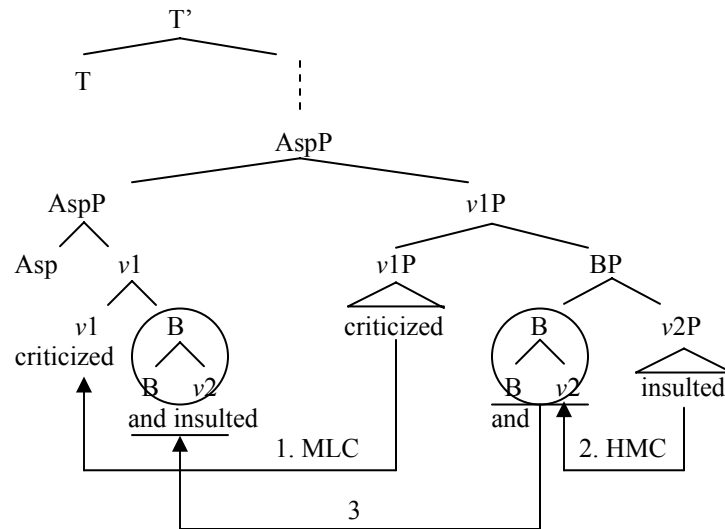

- (25) a. John-ga sono ronbun-o kopiisi-(and)-fairusi-ta.  
John-Nom that paper-Acc copy-(and)-file-Past  
'John copied and filed that paper.'

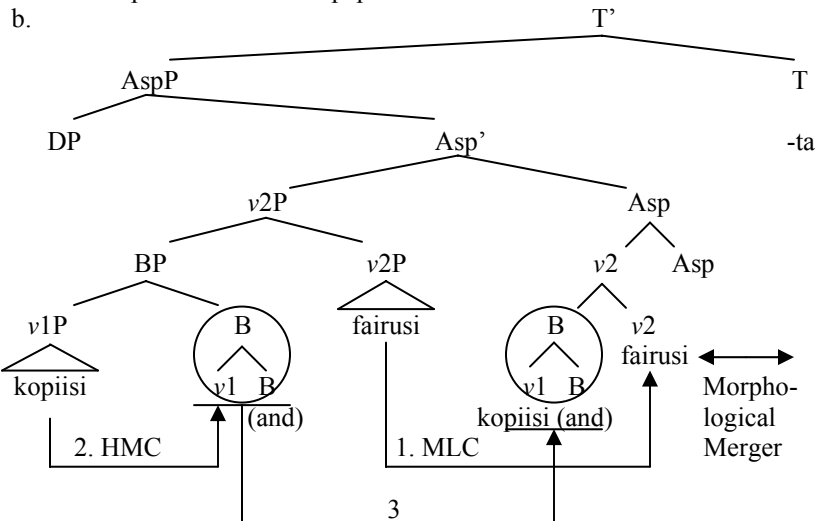

In the process, there is an intervening head, B, so following the HMC the lower  $v$  raise to B at first. There, the lower verb cannot move over B, since they share the same verbal feature, following the spirit of the RM. Thus, in English the

lower  $v$  right-adjoins to B whereas in Japanese it left-adjoins to B. This is shown in the circle. Finally, the complex head in the circle raises to the complex head already formed in the first step. This process also exhibits the “RM effects” and the former complex head cannot move over the latter. In other words, it creates right-adjunction in English and left-adjunction in Japanese. In both languages, the generated word order of the coordinated verb is correct.

The proposed analysis also accounts for the two properties of  $V^\circ$  coordination. The strict adjacency is because of the complex heads formed by the multiple verb movement. The constituency between one verb and the conjunction is the result of the HMC. Specifically, in both (24) and (25), when the lower  $v$  raises to Asp, the HMC requires it to raise to the intervening head B between the lower  $v$  and Asp, as shown in the circle. The lower  $v$  differs in the two languages. In English, it is the 2<sup>nd</sup>V in the linear order, whereas in Japanese it is the 1<sup>st</sup>V. This is why the constituency holds between the 2<sup>nd</sup> verb and the conjunction in English, while in Japanese between the 1<sup>st</sup> verb and the conjunction.

Finally as an evidence supporting the proposed analysis of verb movements, I derive the Japanese verbal compound as in (26). Specifically, I combine the proposed analysis of verb movements and Nishiyama’s (1997) analysis of Japanese verbal compound that it has a VP-shell with one  $vP$  above it.

(26) a. Ken-ga Bill-o osi-taosi-ta  
 Ken-Nom Bill-Acc push-topple-Past  
 ‘Ken pushed Bill down.’

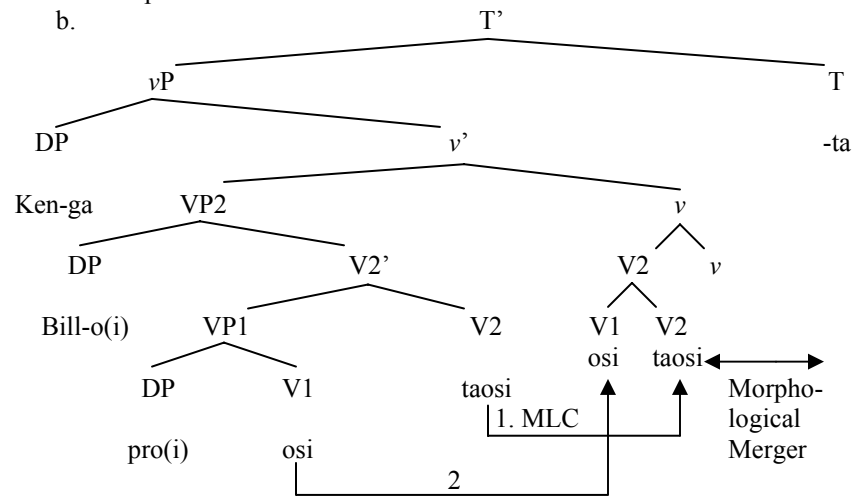

In (26), [+multiple] in the functional head,  $v$  motivates the multiple verb movement. In the first step, the higher verb  $V2$  raises to  $v$  because of the MLC. In the next step, the lower verb  $V1$  raises to  $v$ . All the verb movements are left-

adjunction, since the light verb and both of the verbs have the same verbal feature. The derived verbal compound follows the analysis of *sou* substitution in (11). *Sou* can substitute either only the 1<sup>st</sup>V or both the 1<sup>st</sup>V and 2<sup>nd</sup>V, but not only the 2<sup>nd</sup>V.

## 5. Implications of the study

The first implication of this study is that both in English and Japanese, Asp is [+multiple]. In Japanese, from the example (26), *v* is also [+multiple]. One theoretical expectation from them is that the verbal compound coordination is possible in Japanese. This expectation is borne out as in (27).

- (27) a. Ken-ga Tom-o osi-taosi-(and)-naguri-korosi-ta  
 Ken-Nom Tom-Acc push-topple-(and)-punch-kill-Past  
 ‘Ken pushed Tom down and killed him by punching.’  
 b. Ken-ga tobi-agari-ni-tobi-agat-ta  
 Ken-Nom jump-rise-NI-jump-rise-Past  
 ‘Ken jumped up and jumped up’

The derivations of (27) goes as follows. At first the two independent verbal compounds are formed in each *v*P for [+multiple] in *v*. Then the verbal compound coordination is generated from the multiple movement of the two verbal compounds for [+multiple] in Asp.

One immediate question that follows is why English does not have verbal compound coordination and verbal compound itself in the first place. Is it because English *v* is [-multiple]? This should not be the case, since English does not even allow the SVC like (28) where *v* is [-multiple] and only the higher verb raises to *v*. Collins (2002) suggests the reason why English does not allow the corresponding sentence (29) is because of the serialization parameter where the light verb in Ewe licenses multiple V whereas the English counterpart does not.

- (28) Me nya devi-e dzo (Ewe, Collins (1997))  
 ISG chase child-DEF leave  
 ‘I chased the child away.’

- (29) \*I chased the child leave.

This correctly predicts that English does not have SVCs and verbal compounds. However, I would like to suggest an alternative which is based on the definition of SVCs in (13).<sup>7</sup> I suggest that the reason why English does not have either SVCs or verbal compounds, whereas Japanese does, is because of their different inflectional systems. Sakai (1999) and Takano (2004), among others, claim that

in English verbs are inflected before the syntactic derivation while in Japanese verbs and inflectional morphemes are separated and merged in the phonological component under adjacency. In fact, the proposed analysis of  $V^\circ$  coordination in (24) and (25) supports the claim from syntactic derivational point of view. In English in (24), both of the verbs are inflected whereas in Japanese in (25), only the 2<sup>nd</sup> verb, which is adjacent to T, is inflected. Moreover, if the above claim on the two inflectional systems is correct, in English the case like (30) is not allowed where either of the verbs is inflected in SVCs and verbal compounds.

- (30) a. \*I chased the child leave.  
 b. \*I chase the child left.  
 c. \*John criticize-blamed his boss.  
 d. \*John criticized-blame his boss.

The only possible case is (31), where both of the verbs are inflected.

- (31) a. \*I chased the child left.  
 b. \*John criticized-blamed his boss.

However, there is no such case either in English or any other languages. Recall the definition of SVCs, including verbal compounds, in (13) on the tense value. SVCs and verbal compounds have a succession of verbs with one tense value.

However, if the sentence is not a SVC or verbal compound and when the two inflected verbs are coordinated in the complex head, the sentence is allowed. This is the case of  $V^\circ$  coordination (32).

- (32) John criticized-and-insulted his boss.

Again, this contrasts with Japanese, where both verbal compounds and  $V^\circ$  coordination are possible and only the verb which is adjacent to T is inflected.

## 6. Conclusion

In this paper, I have explored the derivation of  $V^\circ$  coordination. The main observation is that  $V^\circ$  coordination is derived from multiple verb movement following the parametrized version of Merge proposed by Saito and Fukui (1998). The main implication of the study is that it argues for the two different inflectional systems in English and Japanese, as claimed by Sakai (1998) and Takano (2004), among others. The claim on the two different inflectional systems connects the two facts observed in this paper: 1. The different manifestation of tense marker in  $V^\circ$  coordination between English and Japanese, 2. The possibility of either of SVCs or verbal compounds in the two languages.

If the conclusion reached is right, the descriptive generalization extracted from there is that at most one tense marker is allowed within a  $\nu$ P. This is the reason why SVCs and verbal compounds are prohibited in English, since in English verbs are inflected before the derivation and the generalization does not allow the two already inflected verbs to appear within a  $\nu$ P. However, in English as in the case of  $V^\circ$  coordination the two inflected verbs are allowed to be introduced in the separate  $\nu$ P and form a complex head by multiple verb movement. In contrast, in Japanese both verbal compounds and  $V^\circ$  coordination are allowed. This is because in the language verbs are introduced in the derivation as bare form and no violation of the generalization occurs. The validity of the claim involves a cross-linguistic examination of SVCs, verbal compounds and  $V^\circ$  coordination with respect to their inflections, which I leave to future research.

## Notes

\* I would like to thank the following people for helpful comments and discussion: Alan Munn, Adam Szczegielniak, Cristina Schmitt and Marcin Morzycki. Thanks also go to the audience at WECOL 2006. All remaining errors are of course mine.

<sup>1</sup> The reason for this is two-fold. First, in Japanese different  $V^\circ$  coordination, the conjunction is phonetically null, so with the type, it is impossible to see the constituency in the coordinated verbs. Secondly, in the different  $V^\circ$  coordination, there is a case where the strict adjacency does not hold. This is shown in (i).

- (i) a. John punched and quickly kicked his boss.  
 b. Ken-ga Tom-o naguri subayaku ket-ta  
 Ken-Nom Tom-Acc punch quickly kick-Past  
 'Ken punched and quickly kicked his boss.'

From the above examples, it appears that there is a type of verb coordination which may be derived by the right-node-raising as in Kayne (1994). However, the analysis still cannot account for the two properties well represented by the same  $V^\circ$  coordination and the data (3) and (4) of the different  $V^\circ$  coordination. The discussion suggests that as long as the different  $V^\circ$  coordination is concerned, there are two types of verb coordination which look like the same. The first exhibits the two syntactic properties while the second does not. This paper is concerned only with the latter case and I use the term  $V^\circ$  coordination only for that. At this point, I do not have any answer as to why the same  $V^\circ$  coordination is not ambiguous between the two structures.

<sup>2</sup> I call the two constructions with separate names. I call the case like (14) SVC and (15) verbal compound.

<sup>3</sup> Here, Collins (2002) assumes that a trace of a verb does not block verb movement. Thus in (16c), the trace of V1 does not block the verb movement of V2.

<sup>4</sup> There are some exceptions to the rule. For example in (ia), the linear order of the two verbs does not necessarily reflect the actual order of the events denoted by the verbs.

- (i) a. Tom sings and dances every day.  
 b. Tom found and recovered the body.  
 c. \*Tom recovered and found the body.

The difference between (ia) and (ib), which follows the rule, seems to be related to the type of the coordinated verbs and their tense. Specifically, in (ia) the coordinated verbs are Activity and in the present. They are habitual and can happen alternately. In contrast, in (ib) the two verbs have end points and they are in the past.

<sup>5</sup> Here, I adapt the coordinate structure analysis by Munn (1993).

<sup>6</sup> The parametrized version of Merge does not disallow right-adjunction in head-initial languages and left-adjunction in head-final languages. This is why BP in (24) can right-adjoin to  $v_1P$  and in (25) left-adjoin to  $v_2P$ . For the reason why the coordinate structure analysis by Munn (1993) is best suited for the analysis of  $V^\circ$  coordination, see Takashima (forthcoming).

<sup>7</sup> In the discussion, I have to limit myself to the argument on English and Japanese due to the lack of the  $V^\circ$  coordination data on Ewe and  $\neq$ Hoan.

## References

- Chomsky, Noam. 1995. *The Minimalist Program*. Cambridge: MIT Press.
- Chomsky, Noam. 2000. 'Minimalist inquiries'. In Roger Martin, David Michaels, and Juan Uriagereka (ed.) *Step by step*, 89-155. Cambridge: MIT Press.
- Collins, Chris. 1997. 'Argument sharing in serial verb constructions', *Linguistic Inquiry* **28**: 461-497.
- Collins, Chris. 2002. 'Multiple verb movement in  $\neq$ Hoan', *Linguistic Inquiry* **33**: 1-29.
- Kageyama, Taro. 1993. *Bumpou to gokeisei*. Tokyo: Hituzi Syobo.
- Kayne, Richard. 1994. *The antisymmetry of syntax*. Cambridge: MIT Press.
- Munn, Alan. 1993. *Topics in the syntax and semantics of coordinate structures*. Ph.D. Dissertation, University of Maryland, College Park.
- Nishiyama, Kunio. 1998. 'V-V compounds as serialization', *Journal of East Asian Linguistics* **7**: 175-217.
- Richards, Norvin. 1997. *What moves where when in which language?*. Ph.D. Dissertation, MIT, Cambridge.
- Rizzi, Luigi. 1990. *Relativized Minimality*. Cambridge: MIT Press.
- Saito, Mamoru, and Naoki, Fukui. 1998. 'Order in phrase structure and movement', *Linguistic Inquiry* **29**: 439-474.
- Sakai, Hiromu. 1998. 'Feature checking and morphological merger', *Japanese/ Korean linguistics* **8**: 189-201.
- Takano, Yuji, 2004. 'Coordination of verbs and two types of verbal inflection', *Linguistic Inquiry* **35**: 168-178.
- Takashima, Masaaki. Forthcoming. Semantical multiple coordination in Japanese. *Proceedings of The first QSJL International Colloquium*.
- Travis, Lisa. 1984. *Parameters and effects of word order variation*. Ph.D. Dissertation, MIT, Cambridge.

Masaaki Takashima  
Department of Linguistics and  
Germanic, Slavic, Asian and African Languages  
Wells Hall  
Michigan State University  
East Lansing, MI 48824, U.S.A.  
takashi3@msu.edu

# Nonreferential Reflexive NPs and a Requirement on One or More Occurrences of an Expression Type<sup>1</sup>

**Erika Troseth**  
CUNY Graduate Center

## 1. Introduction

Sentences (1) and (2) are ambiguous, allowing the interpretations in (1a) and (2a) as well as the interpretations in (1b) and (2b).

- |    |                                     |           |
|----|-------------------------------------|-----------|
| 1. | This book reads itself.             | can mean: |
|    | 1a. This book reads easily.         |           |
|    | 1b. This book reads its own pages.  |           |
| 2. | The chickens killed themselves.     | can mean: |
|    | 2a. The chickens killed easily.     |           |
|    | 2b. The chickens committed suicide. |           |

It is argued here that the ambiguity of sentences like (1) and (2) is to be analyzed as a *syntactic* ambiguity. The proper analysis of (1) and (2) on the (a) interpretations is one in which there is only one NP-occurrence and this occurrence occupies two positions. The proper analysis of (1) and (2) on the (b) interpretations is one in which there are two NP-occurrences and each occurrence occupies one position. Under both interpretations, the indexing (with respect to indexical value) will be identical; it will be as in (3) and (4).

3. [This book]<sub>i</sub> reads [itself]<sub>i</sub>.
4. [The chickens]<sub>i</sub> killed [themselves]<sub>i</sub>.

The syntactic difference is not revealed through the indexing<sup>2</sup> but rather through the number of NP-occurrences in the syntax of these sentences. On the (a) interpretation of (1) and (2) there is only one NP-occurrence, thus only one NP can refer. It will be shown that the referential position or R-position in such sentences is the syntactic subject position. The reflexive NP in these sentences



will be shown not to occupy an R-position. The (a) interpretation will henceforth be called the *nonreferential interpretation*, as the reflexive NP is not in an R-position. On the (b) interpretation there are two NP-occurrences and each occurrence refers. There are two R-positions in such sentences: the syntactic subject position and the position occupied by the reflexive NP. The (b) interpretation will henceforth be called the *referential interpretation*, as the reflexive NP is in an R-position.

The approach taken here distinguishes between occurrences of expressions and the positions they occupy. In cases of movement—such as we see on some analyses (Fiengo, 1974; Keyser & Roeper, 1984; Roberts, 1987; Hoekstra & Roberts, 1993) of English middle voice sentences—it might be said that a single NP-occurrence occupies two positions. The trace position and the surface position are the two positions occupied, as shown in (5).

5. [The book]<sub>*i*</sub> reads *t<sub>i</sub>* easily.

In (3) and (4) two NP positions are occupied—the postverbal position and the preverbal position. It is argued here that the nonreferential interpretation is associated with a syntactic analysis of (3) and (4) in which there is only one NP-occurrence and this occurrence occupies two positions. In the referential case, there are two NP-occurrences; one of these occurrences is in the syntactic subject position, and the other occurrence is in the postverbal position.

The arguments supporting this analysis come from the evaluation of the interpretation of *wh*-questions and comparisons between the nonreferential reflexive sentences above and English middle voice sentences. A requirement relating NP-occurrences to the position they occupy is proposed, and it is asked whether nonreferential reflexive NPs appear elsewhere in the grammar. Throughout the paper, sentences like (1) and (2) on the nonreferential interpretations will be called *nonreferential reflexive sentences*, and sentences like (1) and (2) on the referential interpretations will be called *referential reflexive sentences*.

## 2. Middle Voice and Nonreferential Reflexive Sentences

I adopt here the position (Fiengo, 1974; Roberts, 1987; Fagan, 1988, 1992; Ackema & Schoorlemmer, 1994, 1995) that the external argument of a verb is not realized in the syntax of English middle voice sentences. In these sentences, there is only one NP argument. There are a number of diagnostics that place middle voice sentences and nonreferential reflexive sentences in the same class, a class taken here to be characterized by a syntactic analysis in which these sentences contain only one NP-occurrence.

### 2.1 Failure of control into an adjunct clause

Keyser & Roeper (1984, observation due to R. Manzini) show that while passive sentences allow control into an adjunct clause, middle voice sentences do not. This is one piece of evidence in favor of the presence of the external argument in the syntax of passive sentences and the absence of the external argument in the syntax of middle voice sentences. Middle voice sentences, as in (6), and nonreferential reflexive sentences, as in (7), pattern together in not allowing control into an adjunct.<sup>3</sup>

- 6. \*The dress washed well [PRO to satisfy the costume director]
- 7. \*The dress washed itself [PRO to satisfy the costume director]

### 2.2 Ungrammaticality of adjunct *by*-phrase

The incompatibility of adjunct *by*-phrases with English middle voice sentences has been argued to follow from the absence in the verb's argument structure of the external argument. Middle voice sentences, as in (8), and nonreferential reflexive sentences, as in (9), disallow an adjunct *by*-phrase.

- 8. \*The cabinets assembled easily by the carpenter.
- 9. \*The cabinets assembled themselves by the carpenter.

Note that although middle voice sentences are often claimed to be stative (Keyser & Roeper, 1984; Roberts, 1987), stativity is not responsible for the unavailability of the *by*-phrase, as (10) and (11), both instances of passivized lexically stative verbs, show.

- 10. German is/was known by at least four people.
- 11. John is/was loved by his parents.

### 2.3 Unavailability of agent-oriented interpretation of adverbs

Agent-oriented adverbs cannot be interpreted as being predicated of the external argument in middle voice and nonreferential reflexive sentences, as (12) and (13) show.

- 12. \*The book reads (well) reluctantly.
- 13. \*The book reads itself reluctantly.

This is different from the case of passives (14), in which agent-oriented adverbs are grammatical.

14. The book was read reluctantly.

## 2.4 Aspectual profiles

The next set of diagnostics shows that middle voice sentences and nonreferential reflexive sentences have similar aspectual profiles.

### 2.4.1 Future interpretation of simple present and present progressive

The future interpretation of simple present and present progressive middle voice ((15) and (17)) and nonreferential reflexive ((16) and (18)) sentences is not available.

- 15. Silk from France washes poorly (\*tomorrow).
- 16. Silk from France washes itself (\*tomorrow).
- 17. Your novel is reading well (\*next week).
- 18. Your novel is reading itself (\*next week).

The verbs in (15) through (18) allow a future interpretation in the simple present and present progressive when they appear in active voice sentences that contain two NP-occurrences, as (19) and (20) show.

- 19. John washes/is washing the silk from France tomorrow.
- 20. John reads/is reading your novel next week.

In (19) the two NP-occurrences are *John* and *the silk from France*; in (20) the two NP-occurrences are *John* and *your novel*. Note that there is not necessarily an entailment from aspectual profile to number of NP-occurrences a sentence contains. What we see in (15) through (18), though, is similar to what we see with many adjectives—a lexical class that includes many underived one-place predicates.

- 21. John is/is being prepared (\*tomorrow).
- 22. Mary is/is being interesting (\*tomorrow).

The claim here is that middle voice sentences and nonreferential reflexive sentences are instances of what (21) and (22) uncontroversially are: sentences that contain only one NP-occurrence.

### 2.4.2 Unavailability of habitual interpretation of simple present

Simple present tense active voice sentences typically allow, in addition to the future interpretation, a habitual interpretation. An example is in (23). Middle voice and nonreferential reflexive sentences do not allow a habitual interpretation in the simple present tense. While (23) can mean that Mary has a

habit of reading Raymond Chandler novels, no habit regarding the readability of these novels is expressed by the middle voice or nonreferential reflexive sentences in (24) and (25).

- 23. Mary reads novels by Raymond Chandler.
- 24. Novels by Raymond Chandler read well.
- 25. Novels by Raymond Chandler read themselves.

#### 2.4.3 Unavailability of “stage directions” interpretation of simple present

English simple present tense sentences (setting aside lexical stative verbs like *know* and *like*) are typically forced into either a habitual or a stage direction interpretation. Sentence (26) can be used to indicate that John typically or habitually washes the potatoes or it can be used as a stage direction. Like the habitual interpretation, the stage direction interpretation is not available with middle voice and nonreferential reflexive sentences, as (27) and (28) show.

- 26. John washes the potatoes.
- 27. The potatoes wash well.
- 28. The potatoes wash themselves.

#### 2.4.4 Stative verbs

The final diagnostic related to aspect profile is the ungrammaticality of lexically stative verbs in middle and nonreferential reflexive sentences.

- 29. \*French knows well.
- 30. \*French knows itself.
- 31. \*Ice cream hates easily.
- 32. \*Ice cream hates itself.

The diagnostics above have shown that middle voice sentences and nonreferential reflexive sentences demonstrate parallel grammatical behavior. In the next section the interpretation of *wh*-questions is used as a diagnostic to further support the claim that the ambiguity of sentences like (1) and (2) is a syntactic ambiguity and that the (a) interpretation of these sentences corresponds to a syntactic analysis in which (1) and (2) contain only one NP-occurrence.

### 3. R-Expressions, R-Positions, and *wh*-Questions

Referential positions (R-positions) are here defined as positions in which an expression that has a referent or a course of value appears. The former circumstance is what we see in (33) with *John* in the R-position. The latter is what we see in (34), with trace in the R-position.

33. John likes ice cream.  
34. Who *t* likes ice cream?

Using *wh*-questions as a diagnostic, it can be shown that the syntactic subject position of middle voice sentences is to be analyzed as the R-position. In (35) the *wh*-expression *which book* A-bar binds the trace in syntactic subject position. A possible answer to (35) is (36). Example (35) asks for a value, and (36) provides a value, namely the referent of *this book*.

35. Which book *t* reads *t* easily?  
36. This book reads *t* easily.

Using *wh*-questions as a diagnostic, it can also be shown that the syntactic subject position of the nonreferential reflexive construction is an R-position. A variable in that position can be A-bar bound by a *wh*-expression, as in (37). (37) can be used to ask someone to identify the book that reads well, and (38) is a possible answer to this question.

37. Which book *t* reads itself?  
38. This book reads itself.

This same diagnostic shows that the reflexive NP on the nonreferential interpretations is *not* in an R-position, or at least is not referential.

39. What does this book read *t*?

If the sentence *This book reads itself* is provided as the answer to (39), only the referential interpretation is available (the interpretation in which the book reads its own pages). This is because the postverbal position in (39) is an R-position and because a condition on the use of *wh*-questions requires that the asker believe that a referring expression can be provided as the answer to her question.

The data in (33) through (39) show that under the nonreferential interpretation of sentences like (1) and (2), there is only one R-position and that this position is the syntactic subject position. The reflexive NP in these sentences does not refer. Therefore it is senseless to ask for its referent. In section two, parallels were drawn between middle voice sentences and nonreferential reflexive sentences. *Wh*-questions have provided further support for the proposal that the nonreferential reflexive construction contains only one NP-occurrence. The R-position associated with this NP-occurrence is the syntactic subject position. It is also true of passive sentences such as (40) that the R-position is the syntactic subject position. This is shown in (41).

40. The book was read *t*.

41. Which book  $t$  was read  $t$ ?

The *wh*-question in (42)—a middle voice question—further supports the parallel between middle voice and nonreferential reflexive sentences. The answer to (42) can be (43) or (44).

42. How does this book read?

43. It reads beautifully.

44. It reads itself.

It was shown above that (39) cannot be used to ask about the book's readability. If the lower NP position in (39) is analyzed as being occupied by a *wh*-trace, (39) can only be used to ask a fairy tale question about what the book actually reads. If the lower NP position is analyzed as occupied by an NP-trace, it is A-bound by the NP *this book*, and the NP *this book* is A-bar bound by the *wh*-expression *what*, as shown in (45).

45. [What]<sub>*i*</sub> does [this book]<sub>*i*</sub> read  $t_i$ ?

This A-bar binding scenario is not permitted by syntax; neither is analyzing the lower NP in (39) as *simultaneously* an NP-trace and a *wh*-trace. The only option permitted by syntax is that in which the trace is in an R-position and is A-bar bound by the *wh*-expression.

#### 4. Nonreferential Reflexives Elsewhere in the Grammar

Having identified one instance of nonreferential reflexive NPs, it should be asked whether such NPs appear elsewhere in the grammar. The reflexive NP in (46) can be diagnosed as a referential NP, given that it can be a response to the question in (47). That (48) is not an answer to the very strange question (49) diagnoses the reflexive NP in (48) as nonreferential.

46. Mary<sub>*i*</sub> invited herself<sub>*i*</sub>.

47. Who did Mary invite  $t$ ?

48. Mary<sub>*i*</sub> behaved herself<sub>*i*</sub>.

49. Who did Mary behave  $t$ ?

Further considerations also diagnose the reflexive NP in (48) as nonreferential. Given the indexing in (50) and (51), these sentences violate Binding Theory Condition C.

50. Mary<sub>*i*</sub> invited Mary<sub>*i*</sub>.

51.  $Mary_i$  behaved  $Mary_i$ .

Such examples are discussed in Fiengo & May (1994), adapting ideas of Evans (1980). They are claimed to belong to a “mathematical” metafragment or register in which sameness of “shape” determines reference and Binding Theory (Condition C) is in a sense “off.” The coindexing in (50) indicates that we have two occurrences of the expression *Mary*. Since two occurrences of the same expression type must refer to the same item, it follows that the referent of the NP that follows the verb *invited* is *Mary*. Thus the sentence means that for a given “inviting event” *Mary* was both the inviter and the invited. In this register, (51) would be expected to be acceptable if the NP following the verb *behaved* has a referent. As in (50), the referent will be the same as the referent of the NP that precedes the verb, given the NPs and indexing indicated. But even in this register, (51) is not acceptable. This shows that the NP that follows the verb *behave* is not in an R-position. The *behave* example provides another case of nonreferential reflexives in the grammar.

## 5. Proposed Requirement

Conditions on reflexive NPs are often written with the aim of accounting for how their referents are determined. It has been argued here that the reflexive NPs in (1) and (2) on the interpretation being considered here do not refer. Since they do not refer, they cannot be coreferent with anything nor can they depend for reference on anything. This entails that an account of anaphora—a syntactic account of anaphora—without coreference must be provided. The formal principle below capitalizes on the traditional but often implicit distinction between types, occurrences, and tokens that is an essential component of generative linguistics (see, for example, Bromberger, 1993).

52. **Formal Principle:** 1) Each NP-occurrence has a referent or course of values; and 2) For any NP-occurrence there is at most one R-position that it is in.

The syntactic and semantic principle (52) is written in such a way as to handle all sentences that include one or multiple occurrences of an expression type. The principle handles (1) and (2) on the referential interpretation. In these examples, there are two NP-occurrences, each of which has a referent. Each NP-occurrence occupies only one R-position, and thus these sentences contain two R-positions each. The reflexive NPs are bound “close,” and the two NP-occurrences in each sentence have the same referent. The principle also handles (1) and (2) on the nonreferential interpretation. In these examples, there is one NP-occurrence, and this occurrence has a referent. The sole NP-occurrence occupies only one R-

position, diagnosed as the syntactic subject position rather than the position that the reflexive NP is in. This analysis can be extended to the *behave* case in (48). The principle also handles quantificational contexts given that occurrences are taken to have a referent or a course of values.

It is known (see for example, Fiengo & May, 1994; Evans, 1980) that expressions with distinct indices may refer to distinct items or to the same item. It might be thought that expressions with the same index must refer to the same item, but the data and account provided here argue against such a view. If movement is to be brought under the account of binding, as argued in Fiengo 1974, 1980, a weaker view is required; *John was arrested t* does not mean *John arrested himself*. If one or more expressions bear the same index, it is simply not allowed that more than one referent is picked out by these expressions. It is allowed that some or all of the expressions do not refer at all. The requirement holds in all cases described here: those with referential and nonreferential reflexive NPs, and those in which an occurrence occupies only one or more than one position.

Note that the analysis proposed here has implications for the Case properties of the sentences discussed. If, as standardly assumed, each NP-occurrence must bear Case, then only one Case—presumably Nominative—is assigned to the NP-occurrence in sentences like (1) and (2). This has implications for languages that mark middle voice sentences with what is typically analyzed as a weak reflexive marker (SE of Romance, *sich* in German). For example, *ce livre* and *se* in (53), if properly analyzed as one NP-occurrence, bear one Case.

53. Ce livre se lit facilement.  
 This book SE reads easily.  
 ‘This book reads easily’

These implications are simply noted here and are not treated in detail, but they are natural extensions of the main arguments and proposals in this paper. For detailed discussion, see Troseth (in progress).

## 6. Conclusions

It has been argued here that sentences like (1) are *syntactically* ambiguous. When (1) is interpreted as (1a), it shares with English middle voice sentences an analysis in which the sentence contains one NP-occurrence.

1. This book reads itself  
 1a. This book reads easily.



The NP-occurrence occupies two positions and is pronounced in both of them. For discussion of conditions under which an NP-occurrence can be pronounced in more than one position see Nunes (1999, 2004), Hornstein (2001), and Trosseth (in progress). The syntactic subject position has been diagnosed as an R-position, and the postverbal position has been diagnosed as not being an R-position. The view adopted here (contra Hornstein (2001)) is that the referential capabilities of an expression can be “exercised” no more than once. This is what we see with middle voice sentences and with (1) interpreted as (1a). When (1) is interpreted as (1b), it shares with typical transitive active voice sentences (like (54)) an analysis in which the sentence contains two NP-occurrences.

- 1b. This book reads its own pages.  
 54. Mary reads *The Gastronomical Me*.

## Notes

1. I thank Robert Fiengo, Marcel den Dikken, William McClure, Christina Tortora, Jed Shahr, Stephanie Solt, Rachel Szekely and the NYU and other CUNY colleagues who have talked with me about this topic. All shortcomings and flaws are my responsibility.
2. This is true for the indexical value, but the picture is more complicated when indexical type is considered. See Trosseth (in progress) for discussion.
3. In some cases, “\*” will be appended to sentences that are syntactically ambiguous and that are grammatical under one analysis and interpretation but not under the analysis and interpretation relevant in the text. For example, (6) and (7) allow an analysis in which the dress is agentive and is performing an action to satisfy the costume director. The syntactic analysis of (6) and (7) on this interpretation is different from the syntactic analysis of (6) as a middle sentence and (7) as a nonreferential reflexive sentence.

## References

- Ackema, Peter and Maaïke Schoorlemmer. 1994. “The Middle Construction and the Syntax-Semantics Interface”, *Lingua*, **93**. 1:59-90.
- Ackema, Peter and Maaïke Schoorlemmer. 1995. “Middles and Nonmovement”, *Linguistic Inquiry*, **26**. 2:173-197.
- Bromberger, Sylvain. 1993. *On What We Know We Don't Know: Explanation, Theory, Linguistics, and How Questions Shape Them*. Chicago: University of Chicago Press.
- Evans, Gareth. 1980. “Pronouns”, *Linguistic Inquiry*, **11**. 2:337-362.
- Fagan, Sarah M.B. 1988. “The English Middle”, *Linguistic Inquiry*, **19**. 2:181-208.
- Fagan, Sarah. 1992. *The Syntax and Semantics of Middle Constructions: A Study With Special Reference to German*. New York: Cambridge University Press.
- Fiengo, Robert Wilson. 1974. *Semantic Conditions on Surface Structure*. Doctoral Dissertation, Massachusetts Institute of Technology, Cambridge, Massachusetts.
- Fiengo, Robert. 1980. *Surface Structure: The Interface of Autonomous Components*. Cambridge, Massachusetts: Harvard University Press.

- Fiengo, Robert and Robert C. May. 1994. *Indices and Identity*. Cambridge, Massachusetts: The MIT Press.
- Hoekstra, Teun and Ian Roberts. 1993. "Middle Constructions in Dutch and English", in Reuland, Eric and Werner Abraham (eds) *Knowledge and Language, Volume II, Lexical and Conceptual Structure*. The Netherlands: Kluwer, 183-220.
- Hornstein, Norbert. 2001. *Move! A Minimalist Theory of Construal*. Oxford: Blackwell.
- Keyser, Samuel Jay and Thomas Roeper. 1984. "On the Middle and Ergative Constructions in English", *Linguistic Inquiry*, **15**. 3:381-416.
- Nunes, Jairo. 1999. "Linearization of Chains and Phonetic Realization of Chain Links", in Epstein, Samuel and Norbert Hornstein (eds) *Working Minimalism*. Cambridge, Massachusetts: The MIT Press.
- Nunes, Jairo. 2004. *Linearization of Chains and Sideward Movement*. Cambridge, Massachusetts: The MIT Press.
- Roberts, Ian G. 1987. *The Representation of Implicit and Dethematized Subjects*. Dordrecht: Foris.
- Troseth, Erika. in progress. *Adicity and Reference: Middle Voice and its Components*.

*Erika Troseth*  
*The Graduate Center of the City University of New York*  
*Linguistics Program*  
*365 Fifth Avenue*  
*New York, NY 10016*  
*etroseth@gc.cuny.edu*

# The Acquisition of the Russian *Or*\* \*\*

Anna Verbuk

University of Massachusetts at Amherst

## 1 Introduction

Cross-linguistically, languages fall into two categories in terms of what reading a sentence has when a disjunction operator is used with clausemate negation. In languages such as English and German, the disjunction operator has a Boolean inclusive interpretation in negative contexts, which results in the reading in (1) that I will refer to as the “neither” reading in this paper.

$$(1) \neg P \wedge \neg Q$$

In English, *or* corresponds to Boolean inclusive disjunction, as in (2).

$$(2) \neg(P \vee Q) \Leftrightarrow \neg P \wedge \neg Q$$

(3) John didn't go to the movies or the concert

“Neither” reading: John didn't go to the movies and John didn't go to the concert.

In contrast, in Russian, Hungarian and a number of other languages, the sentence where the disjunction operator is used in a negative context has an “I don't know which” interpretation, which corresponds to the reading in (4) (Szabolcsi, 2002).

$$(4) \neg P \vee \neg Q$$

Consequently, the use of the Russian “or,” *ili*, in negative contexts does not give rise to the “neither” interpretation of the sentence. In the Russian counterpart of (3) in (5), only the “I don't know which” reading is possible.

(5) Ivan ne xodil  $\vee$  kino ili na koncert

Ivan not go<sub>PAST</sub> in movies or on concert

‘Ivan did not go to the movies or did not go to the concert.’

“I don't know which” reading: Ivan didn't go to the movies or Ivan didn't go to

the concert.

To convey the reading where both disjuncts are negated, the “neither... nor” form is used in Russian, as in (6).

- (6) Ivan ne xodil ni v kino ni na koncert  
 Ivan not go<sub>PAST</sub> neither in movies nor on concert  
 ‘Ivan went neither to the movies nor the concert.’

Two accounts of the behavior of *ili* are possible. The first possibility is that *ili* is not a Boolean operator and has a semantics that is different from that of the English *or*. The second possibility is that *ili* is a Boolean operator that is interpreted outside of the scope of negation in negative contexts like the one in (5). On this account, the only difference between *or* and *ili* is that *or* is interpreted within the scope of sentential negation and *ili* is interpreted outside of the scope of negation.

To test between these two accounts, it will be useful to examine the behavior of *or* and *ili* under matrix negation in embedded contexts. As expected, the sentence containing the English *or* in an embedded context receives a “neither” interpretation (7).

- (7) Mary did not say that John went to the movies or the concert.  
 “Neither” reading: Mary did not say that John went to the movies, and Mary did not say that John went to the concert.

The sentence containing the Russian *ili* under matrix negation in an embedded context receives a “neither” interpretation as well (8).

- (8) Maša ne skazala, što Ivan xodil v kino ili na koncert  
 Masha not say<sub>PAST</sub> that Ivan go<sub>PAST</sub> in movies or on concert  
 ‘Masha did not say that Ivan went to the movies or the concert.’  
 “Neither” reading: Mary did not say that John went to the movies, and Mary did not say that John went to the concert.

The use of both *or* and *ili* gives rise to the “neither” reading of the sentence when the disjunction operators in question are used inside a restrictive relative clause as well, as (9) and (10) illustrate.

- (9) Mary did not see the professor who can run a marathon or do semantics.  
 “Neither” reading: Mary did not see the professor who can run a marathon and do semantics.

(10) Maša ne videla profesora kotoryj mozet probežat' marafon ili  
 Mary not see<sub>PAST</sub> professor who can run marathon or  
 zanimat'sja semantikoj  
 do semantics

'Mary did not see the professor who can run a marathon or do semantics.'

'Neither' reading: Mary did not see the professor who can run a marathon and do semantics.

As evidenced by (8) and (10), the Russian *ili* behaves as a Boolean operator in embedded contexts. These data support the account on which *ili* is, in fact, a Boolean operator. While *ili* has the inclusive semantics, when it is used with clausemate negation, as in (5), the sentence receives an "I don't know which" reading for the following reason. As was argued by Szabolcsi (2002), the disjunction operators in Hungarian, Russian and Italian have the status of PPIs; when the disjunction operator is used with clausemate negation, the disjunction operator takes wide scope and the sentence receives an "I don't know which" interpretation.

## 2 Acquisition Predictions

In the previous studies on the acquisition of disjunction, it was found that at the age of 4 children were able to interpret the English *or* as having a Boolean inclusive interpretation under the scope of negation (Gualmini et al. 2000, Chierchia et al. 2001, Crain et al. 2002). At the same time, in the experiments described in Chierchia et al. (2001), it was found that when *or* was used in a non-downward-entailing environment, 50% of the time children erroneously accepted the inclusive reading instead of the target "I don't know which" reading of the sentence. These experiments are evidence to the effect that children acquiring English start out by interpreting the disjunction as logical, i.e., *inclusive*, and learn to compute the exclusivity implicature at a later point.

Cross-linguistically, disjunction has the status of a PPI in some languages, such as Hungarian and Russian, and does not have the status of a PPI in languages such as English and German. Whether or not disjunction is a PPI in a given language is language-specific lexical information that children learn from being exposed to sentences where disjunction appears with clausemate negation and sentences where disjunction appears with extracausal negation. Disjunction is subject to a lexical parameter with values {+PPI, -PPI}. Next, I will discuss what the default setting of the parameter in question provided by UG must be.

There is some evidence that seems to suggest that the default setting of the PPI parameter must be "-PPI"; the "-PPI" setting of the parameter gives rise to a smaller grammar than the "+PPI" setting thereof in the case of (11) and (12) below.

(11) Mary does not speak Russian or German.

“Neither” reading: Mary does not speak Russian and Mary does not speak German.

(12) Maša ne govorit po-ruski ili po-nemecki

Masha not speak Russian or German

‘Mary does not speak Russian or German.’

“I don’t know which” reading: Mary does not speak Russian or Mary does not speak German.

In every situation in which the “neither” reading of (11) is true, the “I don’t know which” reading of (12) will be true. Every situation where Mary speaks neither Russian nor German is also a situation where she does not speak one of the languages in question. However, if (12) is true in a given situation, it does not follow that (11) is true in this situation. If Mary does not speak one of the languages, it does not follow that she speaks neither of the languages. Therefore, (11) is true in a subset of situations of the set of situations where (12) is true. In accordance with the Subset Principle, the default setting of the PPI parameter must correspond to the smaller grammar which, in this instance, is the grammar of English. On the basis of this evidence, it appears that the default setting of the PPI parameter must be “-PPI.” If the default setting of the PPI parameter were “+PPI,” this state of affairs would have given rise to a learnability problem. All of the input that the child was exposed to would have been compatible with his grammar, and he would not have been able to arrive at a smaller grammar on the basis of positive input.

However, there is also evidence according to which the English grammar is, in fact, in the superset relation to the Russian grammar, which is provided below.

(13) Mary does not speak Russian or German.

Preferred “neither” reading: Mary does not speak Russian and Mary does not speak German.

Possible “I don’t know which” reading: Mary does not speak Russian or Mary does not speak German.

The English sentence in (13) has not only the preferred “neither” reading but also may be construed as having an “I don’t know which” reading in a very limited range of contexts, for example, if it is uttered in the context in (14).

(14) A: I know that Mary does not speak one of the languages that were in the job description. Do you remember what language she doesn’t speak?

B: Mary does not speak Russian or German (I don’t remember which).

In contrast, the Russian counterpart of (13) in (15) can only have the “I don’t know which” reading.

(15) Maša ne govorit po-russki ili po-nemecki

Masha not speak Russian or German

‘Mary does not speak Russian or German.’

“I don’t know which” reading: Mary does not speak Russian or Mary does not speak German.

While the English sentence in (13) has both the preferred “neither” reading and the less common “I don’t know which” reading, its Russian counterpart in (15) has only the “I don’t know which” reading. In this instance, the Russian grammar appears to be “smaller” than the English one.

To summarize, the Russian and English grammars are not in a subset / superset relationship; rather, there is a partial overlap between the two grammars – both grammars allow the “I don’t know which” reading. Thus the Subset Principle does not enable us to determine what the default setting of the PPI parameter must be. It is more economical to interpret the disjunction operator in its syntactic position. While the “-PPI” setting makes the isomorphic interpretation available, the “+PPI” setting makes the non-isomorphic interpretation available. In view of economy considerations, I hypothesize that the child should start out with the default “-PPI” setting.

If a child is acquiring an English-type language where the default setting corresponds to that of the target language, the “-PPI” setting is retained. If a child is acquiring a Russian-type language where “-PPI” is not the parameter setting of the target language, the child is liable to go through an “English” stage during which he will retain the default “-PPI” setting of the parameter. Since the Russian and English grammars are in the partial overlap relationship, in principle, the child may start out with either setting of the parameter and reset it as a result of experience. The resetting of the parameter will not create a Subset Problem. However, the child may not start out with a grammar that generates sentences that are licit both on the “+PPI” and “-PPI” settings of the parameter, and then arrive at a grammar where the parameter setting is “+PPI” or “-PPI.” In view of this, I will propose a trigger that may change the initial “-PPI” setting of the PPI parameter for the Russian-acquiring child as well as a trigger that may change the initial “+PPI” setting of the parameter for a child acquiring English. In the remainder of the paper, I will discuss the experiment on the acquisition of *ili*, and how a child arrives at the correct setting of the PPI parameter in the grammar of the target language.

### 3 The Experiment

In the present experiment, I tested Russian-speaking children on sentences where *ili* was used with clausemate negation. Since my hypothesis is that the initial setting of the PPI parameter is “-PPI,” my experimental hypothesis is that there is a stage where children interpret sentences where *ili* is used with clausemate negation on the “neither” reading.

H<sub>1</sub>: Children acquiring Russian go through a stage where they interpret sentences where *ili* is used with clausemate negation on the “neither” reading.

#### 3.1 METHODS

21 3;11-6;10-year-old Russian-speaking children who attended Shaloh House school in Brighton, Massachusetts, “School is Cool” day care center and Brookline Dance studio in Brookline, Massachusetts participated in the experiment. Children’s mean age was 5;4. All of the children were native speakers of Russian. The entire experiment was conducted in Russian. The standard picture-matching task was used, where the child is shown two pictures, one that corresponds to the test sentence and one that doesn’t, and is asked to choose the “right” picture.

The storyline was as follows. Lion hid a key and a mirror in two identical boxes and promised to give a basket with strawberries to animals who found both the key and mirror. Subsequently, different animals took turns looking for the boxes. In the “or” condition, the child was shown a picture where an animal found one box and a picture where an animal found nothing. Consider an “or” condition test sentence and a pair of pictures that were used with this sentence.

(16) Lion did not give Cat a basket with strawberries because Cat did not find the key or the mirror.

Experimenter: show me a picture where this is shown.



Picture one.



Picture two.



Each child was told ten short stories individually. Of the ten stories, there were 6 items where *ili* was used with clausemate negation; the child's task was to choose between a picture that corresponds to the reading on which *ili* takes wide scope with respect to negation (the target response) and a picture that corresponds to the reading where the negation scopes over *ili*. Two stories tested the children on the *ni... ni* or "neither... nor" construction which is in complimentary distribution with constructions where *ili* scopes over negation. In the case of the *ni... ni* construction, the child's task was to choose between a picture where negation applied to both DPs in question vs. the one where it applied only to one DP. The fact that I used the *ni... ni* construction may have served as an additional clue to the effect that the construction where *ili* was used with clausemate negation was to be interpreted with *ili* scoping over negation. If *ili* is interpreted as scoping below negation, the two constructions have the same interpretation – the "neither" reading. Two stories with the *i... i* or "and" construction were used as controls in order to ensure that individual children were paying attention to the experimental task. I did not expect even the younger children to experience difficulties with this construction. (See Appendix for the detailed description of the experimental materials).

### 3.2 RESULTS

16 out of 21 children consistently provided the incorrect "neither" interpretation of sentences where *ili* was used with clausemate negation.  $H_1$  according to which children acquiring Russian go through a stage where they interpret sentences where *ili* is used with clausemate negation on the "neither" reading was supported. The Chi-Square = 696.24,  $df=6$ ,  $N=21$ ,  $p < .001$ .

Also, 6 adult controls who were native speakers of Russian were tested. In the "or" condition, they provided 100% of the target "I don't know which" reading responses. In the "neither... nor" and "and" conditions, 100% of the target responses were provided as well.

### 3.3 DISCUSSION

I found that 16 children computed the incorrect "neither" interpretation of sentences where *ili* was used with clausemate negation 98.9% of the time. These 16 children also provided 93.7 % of correct responses in the *ni... ni* or "neither... nor" condition, and they provided 100% of correct responses in the "and" condition. These children are at a stage where they have not learned that *ili* is a PPI and interpret it under the scope of negation. These children's results are summarized in Table 1 below.

Subject #	Age	Or	Neither... nor	And
1	4;5	0	2	2
3	5;4	0	2	2
4	5;3	0	2	2
5	5;5	0	1	2
6	4;5	0	2	2
7	5;2	0	2	2
8	6;10	0	2	2
11	3;11	0	2	2
13	5;9	0	2	2
14	5;4	0	2	2
15	4;5	1	1	2
16	5;5	0	2	2
17	5;2	0	2	2
18	5;5	0	2	2
19	6;3	0	2	2
20	6;5	0	2	2

Table 1. The Key: the number of correct responses in each condition is given.

Interestingly, it was found that four children who consistently computed the correct “I don’t know which” interpretation of sentences where *ili* was used with clausemate negation also consistently provided erroneous responses in the *ni... ni* “neither... nor” condition. Thus the four children in question computed the correct “neither” interpretation of sentences where *ili* was used with clausemate negation present 91.7% of the time. However, the four children also provided no correct responses in the “neither... nor” condition and 87.7% of correct responses in the “and” condition. These children’s results are provided in Table 2 below.

Subject #	Age	Or	Neither... nor	And
2	4;11	6	0	2
9	6;3	6	0	1
10	6;2	6	0	2
12	6;6	4	0	2

Table 2. The Key: the number of correct responses in each condition is given.

The four children’s unexpectedly poor performance on the “neither... nor” condition makes it dubious that they performed well on the “or” condition because they have correctly classified *ili* as a PPI and interpreted it outside the

scope of negation. It may be the case that the four children in question had trouble interpreting the scope of negation both in the “or” and “neither... nor” conditions. In the “neither... nor” condition, the child was shown a picture where an animal found one box, which corresponded to the erroneous reading on which negation applied only to one DP, and a picture where an animal found nothing, which corresponded to the target reading on which negation applied to both DPs. An example of a test sentence that a child was given in the “neither... nor” condition is provided in (17).

(17) Cat found neither the key nor the mirror.  
 Experimenter: Show me a picture where this is shown.

The four children in question consistently picked the picture where an animal found one box, i.e., computed the reading where negation applied only to one DP. This is evidence to the effect that these children consistently assigned the wrong scope to the negation operator in the “neither... nor” condition. Importantly, it was precisely these four children who provided responses that appeared to have the “I don’t know which” interpretation in the “or” condition. Thus it is plausible that these children interpreted only one of the DPs in the scope of negation in the “or” condition as well. In the “or” condition, the child was asked to choose between a picture where an animal found one box and a picture where it found nothing. The four children picked the picture where an animal found one box and rejected the picture where the animal found nothing; these children interpreted only the DP in the first disjunct under the scope of negation. Thus my hypothesis is that these children provided what appeared to be the target responses in the “or” condition not because they correctly interpreted *ili* as a PPI but because they misinterpreted negation as applying to the DP in the first disjunct instead of as applying to both DPs. In (18), I illustrate what interpretation these children must have arrived at if they interpreted negation as applying to the DP in the first disjunct and not to both DPs.

(18) Koška ne našla klučik ili zerkal’ce  
 cat not find<sub>PAST</sub> key or mirror  
 ‘Cat did not find the key or the mirror.’

Child’s erroneous “one DP” interpretation: Cat either did not find the key or found the mirror.

If the child misinterprets (18) in this manner, given a choice between a picture where Cat found one box and a picture where Cat found nothing, the child will pick a picture where Cat found one box. Only this picture matches the child’s interpretation of (18). Picking a picture where Cat found one box happens to be the target response because the Russian “or” takes scope over the clausemate negation<sup>1</sup>.

Next, consider why the four children in question provided the wrong responses in the “neither... nor” condition. An example of a test sentence is given in (19).

- (19) Medved' ne našël ni klučik ni zerkal'ce  
 bear not find<sub>PAST</sub> neither key nor mirror  
 ‘Bear found neither the key nor the mirror.’

Child’s erroneous “one DP” interpretation: Bear either did not find the key or found the mirror.

If the child misinterprets (19) in this manner, given the choice between a picture where Bear found nothing and a picture where he found one box, the child will pick a picture where Bear found one box. It is this picture that matches the child’s construal of (19). In contrast to the “or” condition, in the “neither... nor” condition, picking a picture where Bear found one box is not the target response.

To summarize, the four children’s responses cannot be taken as evidence to the effect that these children correctly interpret the Russian *ili* as a PPI. While these children did end up interpreting *ili* as being outside of the scope of negation in the “or” condition, they did so because they erroneously applied negation only to the DP in the first conjunct.

Finally, one 3;5-year-old child, who was the youngest subject, provided 50% of correct responses in the “or” condition. This child’s responses are provided in the table below.

Subject #	Age	Or	Neither... nor	And
21	3;5	3	2	1

Table 3. The Key: the number of correct responses in each condition is given.

In the “or” condition, the child was guessing between the “I don’t know which” and “neither” readings of sentences; this may have been due to the fact that the child very young and the kind of inferential reasoning she had to go through in order to pick out a picture that matched her reading of the *ili* sentence was too challenging.

#### 4 Conclusion

It was found that Russian-speaking children go through an “English” stage in interpreting *ili* in contexts where clausemate negation is present. At this stage, Russian-speaking children interpret sentences where “or” is used with clausemate negation on the “neither” reading. Thus my hypothesis that Russian-speaking children go through a stage where they interpret sentences where *ili* is

used with clausemate negation on the “neither” reading was supported. I hypothesized this stage based on the view that the default setting of the PPI parameter is “-PPI.” 16 children were precisely in a stage where they interpreted the sentences in question on the “neither” reading because they have not changed the default setting of the PPI parameter to that of the target language.

The fact that the initial setting of the PPI parameter is “-PPI” gives rise to the following learnability problem that is illustrated on the example of (20) and (21).

(20) Cat did not find the key or the mirror.

Preferred “neither” reading: Cat did not find the key and Cat did not find the mirror.

Possible “I don’t know which” reading: Cat did not find the key or Cat did not find the mirror.

(21) Koška ne našla klučik ili zerkal’ce

cat not find key or mirror

‘Cat did not find the key or Cat did not find the mirror.’

“I don’t know which” reading: Cat did not find the key or Cat did not find the mirror.

While the English sentence in (20) has both the preferred “neither” reading and the less common “I don’t know which” reading, its Russian counterpart in (21) has only the “I don’t know which” reading. If a child acquiring Russian goes through an “English” stage where (21) is interpreted as having the “neither” and “I don’t know which” readings, her task is to arrive at a grammar where (21) is interpreted as having just the “I don’t know which” reading. The child will hear sentences such as (21) in contexts where the “I don’t know which” reading is relevant, and she will be able to interpret them on this reading without changing the setting of the PPI parameter because this reading is licit in languages where the setting of the PPI parameter is “-PPI,” such as English. The child acquiring Russian will first hypothesize that the “I don’t know which” reading is licit only in contexts that force it, as in (14). Upon having received sufficient exposure to a broad range of contexts where this reading is licensed in Russian, the child will eventually realize that the “I don’t know which” reading is licensed in any context.

Next, I will discuss the type of input that may serve as a trigger for changing the default setting of the PPI parameter to “+PPI.” In the positive input, children acquiring Russian are exposed to sentences as in (22).

(22) Ona ne budet tancevat’ ili pet’

she not will dance or sing

‘She will not dance or she will not sing’

“I don’t know which” reading: She will not dance or she will not sing.

For adults, (22) has only the “I don’t know which” reading. The English counterpart of (22), which is in (23), has only the “neither” reading.

(23) She will not dance or sing.

“Neither” reading: she will neither dance nor sing.

For the child acquiring Russian, hearing sentences like (22) that are uttered in contexts where the “I don’t know which” reading is the relevant one serves as the crucial piece of evidence needed to change the setting of the PPI parameter to “+PPI.” This is because the English sentence in (23) lacks the “I don’t know which” reading. To arrive at the “I don’t know which” reading, the child needs to reset the disjunction parameter to “+PPI.”

Finally, I will discuss what type of evidence may serve as a trigger for changing the setting of the PPI parameter from “+PPI” to “-PPI.” (Although the present experiment has provided evidence to the effect that Russian children start out with a “-PPI” setting of the parameter, as was previously mentioned, another theoretical possibility is that a child might start out with a “+PPI” setting). If a child acquiring an English-type grammar starts out with a “Russian” “+PPI” setting, the trigger for resetting the parameter will be sentences as in (20) used in contexts where the “neither” reading is intended. Because this reading is licit only on the “-PPI” setting of the parameter in question, these sentences serve as a trigger for resetting the value of the PPI parameter.

## 5 Appendix

Test sentences:

- (1) Lion did not give Cat a basket with strawberries because Cat did not find the key or the mirror.
- (2) Lion did not give Duck a basket with strawberries because Duck did not find the key or the mirror.
- (3) Lion did not give Deer a basket with strawberries because Deer did not find the key or the mirror.
- (4) Lion did not give Goat a basket with strawberries because Goat did not find the key or the mirror.
- (5) Lion did not give Frog a basket with strawberries because Frog did not find the key or the mirror.
- (6) Lion did not give Bird a basket with strawberries because Bird did not find the key or the mirror.
- (7) Lion did not give Bear a basket with strawberries because Bear found neither

- the key nor the mirror.
- (8) Lion did not give Buffalo a basket with strawberries because Buffalo found neither the key nor the mirror.
- (9) Lion gave Camel a basket with strawberries because Camel found the key and the mirror.
- (10) Lion gave Elephant a basket with strawberries because Elephant found the key and the mirror.

## Notes

---

\* This material is based upon work supported [in part] by the National Science Foundation under Grant No. BCS-0418311 to Barbara H. Partee and Vladimir Borshev for a project entitled, "The Russian Genitive of Negation: Integration of Lexical and Compositional Semantics."

\*\* I thank Tom Roeper and Barbara Partee for their input, and I am grateful to the children, teachers and parents at Shaloh House school in Brighton, Massachusetts, "School is Cool" day care center and Brookline Dance studio in Brookline, Massachusetts.

<sup>1</sup> It is true that the picture where Cat found one box is not a perfect match for the child's reading of the test sentence, "Cat either did not find the key or found the mirror," because the two disjuncts describe the same situation, namely, the one where Cat found the mirror but not the key. However, this is precisely the situation where Cat found one box. Given the choice between a picture where Cat found one box and one where it found nothing, children choose the picture that best matches their reading.

## References

- Chierchia, Genarro, Stephen Crain, Maria Teresa Guasti, Andrea Gualmini and Luisa Meroni. 2001. "The Acquisition of Disjunction: Evidence for a Grammatical View of Scalar Implicatures," *BUCLD 25 Proceedings*: 157-168. Somerville, MA: Cascadilla Press.
- Crain, Stephen, Amanda Gardner, Andrea Gualmini and Beth Rabin. 2002. "Children's Command of Negation," *Proceedings of the Third Tokyo Conference on Psycholinguistics*: 71-95. Hituzi Publishing Company, Tokyo.
- Gualmini, Andrea, Stephen Crain, Luisa Meroni. 2000. "Acquisition of Disjunction in Conditional Sentences," *BUCLD 24 Proceedings*: 367-378. Somerville, MA: Cascadilla Press.
- Szabolcsi, Anna. 2002. "Hungarian Disjunction and Positive Polarity," *Approaches to Hungarian 8*: 217-241. Ed. by Kenesei and Siptár. Akadémiai.
- Szabolcsi, Anna. 2004. "Positive Polarity – Negative Polarity," *Natural Language and Linguistic Theory* 22. 2: 409-452.

Anna Verbuk  
 University of Massachusetts at Amherst  
 Department of Linguistics, University of Massachusetts  
 226 South College, 150 Hicks Way,  
 Amherst, MA 01003-9274, USA  
 averbuk@linguist.umass.edu

# Verb Movement and the Morphosyntax of Negation in Saami

Mikael Vinka  
Umeå University

## 1. Introduction

In the Saami languages (Finno-Ugric) the sentential negation is morphosyntactically realized as an auxiliary verb. This paper will examine some issues that arise regarding the distribution of the pieces of verbal inflection in negated clauses in the two closely related languages South Saami and North Saami. One noticeable difference between these two languages lies in whether or not the negation auxiliary can serve as the host for a tense affix. In North Saami, the negation inflects for agreement, but it cannot not appear with tense morphology. As illustrated in (1), the distinction between the present and past tenses is signaled by means of (default) tense affixes on the main verb, resulting in the distinct forms juga 'drink.Prs' and juhkan 'drink.Pst'. The negation auxiliary itself is held invariant in both cases.

- (1) North Saami
- |   |                            |        |           |            |
|---|----------------------------|--------|-----------|------------|
| a | Don                        | it     | juga      | gáfe.      |
|   | you.s.Nom                  | Neg.2s | drink.Prs | coffee.Acc |
|   | 'You don't drink coffee.'  |        |           |            |
| b | Don                        | it     | juhkan    | gáfe.      |
|   | you.s.Nom                  | Neg.2s | drink.Pst | coffee.Acc |
|   | 'You didn't drink coffee.' |        |           |            |

In South Saami, the negation auxiliary expresses not only agreement, but indeed also tense, as illustrated in (2). A quick comparison of (2a) and (2b) reveals that the distinction between the simple present and past tenses is conveyed by the forms ih 'Neg.Prs.2s' versus idtjih 'Neg.Pst.2s'. In contrast to North Saami, the South Saami main verb appears in an invariant form that is void of tense and agreement markers. It does, however, have the negative suffix -h attached to it, jovkh 'drink.Neg'.

- (2) South Saami
- |   |                           |            |           |             |
|---|---------------------------|------------|-----------|-------------|
| a | Datne                     | ih         | jovkh     | prihtjegem. |
|   | you.s.Nom                 | Neg.Prs.2s | drink.Neg | coffee.Acc  |
|   | 'You don't drink coffee.' |            |           |             |



- b Datne idtjih jovkh prihtjegem.  
 you.s.Nom Neg.Pst.2s drink.Neg coffee.Acc  
 'You didn't drink coffee.'

In this paper, I will argue that the contrast between North Saami and South Saami does not reflect a difference in the way negated clauses are structurally assembled, but follows from an independently motivated factor, namely the strategy used in satisfying the relation between the verb and the inflectional domain. In doing so, we also take issue with the approach presented in Mitchell (2006), who argues that the negation appears in different structural positions in comparable Finno-Ugric languages.

In achieving these goals, it is imperative that we consider the basic facts pertaining to verb movement, which is the topic of section 2. Here we show that North Saami behaves essentially like French. That is, both finite main verbs and finite auxiliaries undergo verb-raising to T. In contrast, South Saami behaves similarly to English, in that finite main verbs do not raise to T, whereas finite auxiliaries do. These facts are of great importance when we consider negated clauses, because it turns out that there is one environment where the South Saami negation cannot be the unique host for tense, namely in clauses involving a auxiliary verb. Here, a North Saami pattern emerges in South Saami:

(3) South Saami

- a Jávva ij leah tjuvliestamme Marjam.  
 Jávva.Nom Neg.Prs.3s be.Prs kiss.Ptc Marja.Acc  
 'Jávva has not kissed Mary.'
- b Jávva ij lij tjuvliestamme Marjam.  
 Jávva.Nom Neg.Prs.3s be.Pst kiss.Ptc Marja.Acc  
 'Jávva had not kissed Mary.'

Section 3 argues that verbs that undergo syntactic verb raising will always express tense in negated clauses, whereas verbs that do not raise will never express tense. Section 4 provides some concluding remarks.

## 2. The v-T Relation in South and North Saami

In this section we will investigate how the relation between T and v is established in South and North Saami. It will be shown that these two languages patterns along the well-known dichotomy distinguishing English and French (see among several others, Emonds 1978, Pollock 1989). Specifically, North Sámi main verbs as well as auxiliaries undergo v-to-T raising, whereas such raising is limited to auxiliaries in South Saami. This finding will be of great importance when considering the morphosyntactic complexities of the negation auxiliaries in these languages.

### 2.1. Main verbs

In order to show that v-to-T raising is operative in North Saami, but not in South Saami, we will employ two widely accepted tests, namely the placement of vP-modifying adverbs and floating quantifiers. Firstly, consider the examples in (4). The contrast between (4a) and (4b) shows that a finite main verb must surface to the left of a vP-adjoined adverb:

- (4) North Saami
- a Don           jugat           **dávjá**   gáfe.  
 you.s.Nom drink.Prs.2s always coffee.Acc  
 'You always drink coffee.'
- b \*Don       **dávjá**   jugan           gáfe.  
 you.s.Nom always drink.Prs.2s coffee.Acc  
 'You always drink coffee.'

Secondly, (5) illustrates that a floating quantifier must appear to the right of the finite main verb:

- (5) North Saami
- a Sii           juhke           **buohkat**   gáfe.  
 they.Nom drink.Prs.3p all coffee.Acc  
 'They all drink coffee.'
- b \*Sii       **buohkat**   juhke           gáfe.  
 they.Nom all drink.Prs.3p coffee.Acc  
 'They all drink coffee.'

Assuming that such elements are adjoined at left edge of vP (e.g. Bobaljik 1995), thus intervening between v and T, the North Saami facts in (4) and (5) should be analyzed in terms of verb raising, similarly to French (Emonds 1978, Pollock 1989). That is, head-to-head movement has the effect of placing the verb in a position to the left of the material appearing at the left edge of the vP.

The pattern that emerges in South Saami clauses with finite main verbs, however, is not compatible with a verb raising analysis. Specifically, a finite main verb must surface to the right of both vP-modifying adverbs and floating quantifiers, as (6) and (7) witness:

- (6) South Saami
- a Datne       **daamtaj**   jovkh           prihtjegem.  
 you.s.Nom often drink.Prs.2s coffee.Acc  
 'You often drink coffee.'
- b \*Datne   jovkh           **daamtaj**   prihtjegem.  
 you.s.Nom drink.Prs.2s often coffee.Acc  
 'You often drink coffee.'

## (7) South Saami

- a Sijjieh *gaajhkesh* juvkieh prihtjegem.  
 they.Nom all drink.Prs.3p coffee.Acc  
 'They all drink coffee.'
- b \*Sijjieh juvkieh *gaajhkesh* prihtjegem.  
 they.Nom drink.Prs.3p all coffee.Acc  
 'They all drink coffee.'

In short, finite main verbs in North Saami raise syntactically to T, in contrast to South Saami, which exhibits English-style affix hopping.

Following Embick & Noyer (2001), I take affix-hopping to be an operation by which T is lowered to v, and that the lowering operation is subject to a syntactic locality constraint, such that T adjoins to the head of the phrase TP immediately dominates, namely v. Embick & Noyer's structurally defined approach to lowering has the advantage that it straightforwardly accomodates South Saami OV clauses. (6) and (7) above showed that a vP-adjoined adverb does not block affix-lowering. (8) below furthermore shows that a preverbal direct object does not impose any blocking effect either. If affix hopping is defined in terms of linear adjacency (see Bobaljik 1995), we are forced to say that the preverbal object *gærjam* 'book.Acc' in (8) appears in a vP-adjoined position below the vP adjoined adverb *daamtaj* 'often.'

- (8) Manne *daamtaj* gærjam lohkem maanide.  
 I.Nom often book.Acc read.Prs.1s children.Ill  
 'I often read books to the children'

Although the fine details of the South Saami VO-OV alternations by and large are unknown, it suffices for our purposes to assume Embick & Noyer's (2001) take on affix lowering.

**2.2. Auxiliaries**

Having established that in the context of finite main verbs, South and North Saami employ different strategies in establishing the relation between v and T, we now turn our attention to auxiliaries. In North Saami, finite auxiliaries surface in same position as finite main verbs do, namely to the left of adverbs, (9) and floating quantifiers, (10).

## (9) North Saami

- a Oahpit *leat* *dávjá* lohkan girjji.  
 students.Nom be.Prs.3p always read.Ptc book.Acc  
 'The students have often read the book.'
- b \*Oahpit *dávjá* *leat* lohkan girjji.  
 students.Nom always be.Prs.3p read.Ptc book.Acc  
 'The students have often read the book.'

## (10) North Saami

- a Oahpit leat **buohkat** lohkan girjji.  
 students.Nom be.Prs.3p all read.Ptc book.Acc  
 'The students have all read the book.'
- b \*Oahpit **buohkat** leat lohkan girjji.  
 students.Nom all be.Prs.3p read.Ptc book.Acc  
 'The students have all read the book.'

Let us now turn to South Saami. We established above that finite main verbs in this language do not undergo verb-raising, but rather T lowers to v. However, when we consider auxiliaries, we find that such items must appear to the left of an adverb, as shown by the contrast between (11a) and (11b). Hence, we have an indication that finite auxiliaries, unlike finite main verbs, in fact raise to T.

## (11) South Saami

- a Learohkh leah **daamtaj** lohkeme gærjam.  
 students.Nom be.Prs.3p often read.Ptc book.Acc  
 'The students often read the book.'
- b \*Learohkh **daamtaj** leah lãhkame gærjam.  
 students.Nom often be.Prs.3p read.Ptc book.Acc  
 'The students often read the book.'

In the light of (11), it is not surprising to find that finite auxiliaries not only surface to the left of adverbs, but also to the left of floating quantifiers, (12). Indeed, the pattern that emerges from (11) and (12) is easily accounted for by the verb raising hypothesis.

## (12) South Saami

- a Learohkh leah **gaajhkes** lohkeme gærjam.  
 students.Nom be.Prs.3p all read.Ptc book.Acc  
 'The students all read the book.'
- b \*Learohkh **gaajhkes** leah lohkeme gærjam.  
 students.Nom all be.Prs.3p read.Ptc book.Acc  
 'The students all read the book.'

In short, North Saami behaves essentially on a par with French in that all finite verbs diagnose positively for movement. South Saami on the other hand, exhibits an English pattern, where main verbs remain in-situ and auxiliaries are subject to verb raising.

### 3. The Morphosyntax of Negation

In the introductory section we saw that the pieces of inflection partly distribute in different ways in North and South Saami. In North Saami, the negation auxiliary inflects for agreement, but never for tense. Tense is expressed on the negated verb appearing below the negation. In South

Saami, on the other hand, the negation expresses both agreement and tense in simple tenses. In complex tenses and copula clauses, a North Saami pattern emerges. That is, the negation expresses agreement, whereas the tense exponent is realized on the *be*-auxiliary. Next, we can now see that there is a strong correlation between the distribution of verbal inflection and verb movement. If the negation appears in a context that independently exhibits verb movement, then the negation will only be associated with agreement. In contrast, when the negation appears in a context where affix lowering is manifested, then it will inflect for both agreement and tense.

Mitchell (2006) presents an analysis in which she aims at accounting for the inflectional differences by arguing that the NegP has different attachment points in North and South Saami style languages. A negated clause in South Saami is assumed to have the following structure, where NegP immediately dominates vP (ignoring argument positions), by virtue of selecting vP:

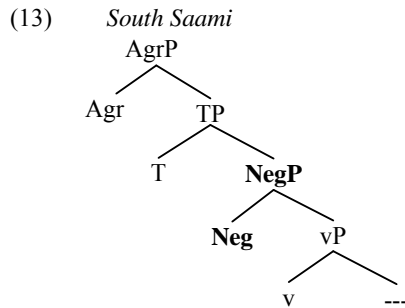

It is not possible for *v* to raise to *T* in (13), because of the intervening *Neg*. *Neg*, however, may raise through *T* to *Agr*, and consequently the negation comes to carry tense and agreement affixes. As for North Saami, Mitchell argues that *Neg* selects a TP complement, yielding (14):

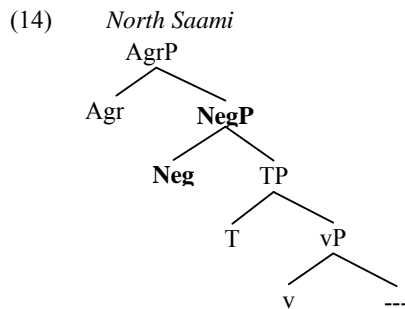

Now *v* can raise to *T*, and consequently it becomes the host of a tense affix. However, further raising of the *v*-*T* complex to *Agr* is prevented by the intervening negation.

While (14) suffices to account for the distribution of inflectional morphology in both simple and complex tenses in North Saami, (13) fails to capture the behavior of negated clauses involving an auxiliary in South Saami. In other words, while (13) can provide an answer why it is the negation rather than the main verb that expresses tense in (15), it fails to capture the fact that it is the auxiliary that carries tense affix in (16), and not the negation:

- (15) Dihte idtjij jovkh prihtjegem.  
s/he.Nom Neg.Pst.3s drink.Neg coffee.Acc  
'S/he didn't drink coffee.'
- (16) Dihte ij lij jovkeme prihtjegem.  
s/he.Nom Neg.3s be.Pst drink.Ptc coffee.Acc  
'S/he has not drunk coffee.'

The only possible way the situation could be resolved in Mitchell's theory would be to allow for two distinct Neg projections in South Saami. On the one hand, one that selects for a vP complement as in (13), and on the other hand, another Neg that selects for a TP complement as in (14). This, however, would fail to capture the correlation between verb movement and the ability of a verb to express tense in a negated clause.

I will propose that once we take verb raising into account, it is possible to maintain that the basic syntactic structure of negated clauses is the same in both North and South Saami. Let us begin by considering South Saami. The crucial point in considering the negation in this language lies in the fact that main verbs do not undergo raising to T. While Mitchell argues that the presence of Neg blocks verb raising to T, it is now clear that this must be restated in terms of affix lowering. Somehow, the negation blocks lowering of T to the verb. In other words, we have a situation closely reminiscent of English. So far, structure (13) will do the job. However, as we have also pointed out, (13) also predicts that (16) should be ruled out, contrary to fact.

In this light, it is important to pay attention to the fact that the sentential negation involves two components. Firstly, the negation auxiliary itself, and secondly, a negative affix appearing on the the highest non-negative verb:

- (17) Dihte idtjij byöpmed<sup>h</sup>.  
s/he.Nom Neg.Pst.3s eat.Neg  
'S/he didn't eat.'

I assume that the suffix  $-h$  appearing on the verb *byöpmed*- 'eat' in (17), is an exponent of Laka's (1990)  $\Sigma$ . Assume further that  $\Sigma$ P immediately dominates vP:

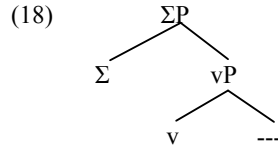

Once we adopt (18), we may also assume the clausal organization Mitchell proposed for North Sami. This gives us (19):

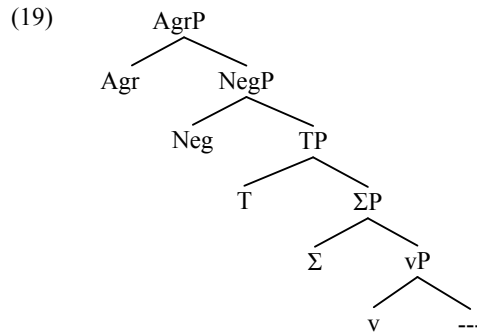

Granted that lowering is sensitive syntactic hierarchies, it follows that T in (19) cannot lower to v, because of the intervening head Σ. However, nothing prevents v from raising through Σ into T, in which case v will serve as a host for the tense affix. This handles all cases in North Saami and the case of auxiliaries in South Saami.

Still, we have to say something more explicit about negated simple tenses in South Sami. In essence, we may now view the fact that the negation auxiliary in these cases host tense morphology as the the equivalent of English do-support. Since T cannot combine with v, some other element must express tense. Embick & Noyer (2001:586) propose that do-support is syntactic, and that it arises from a requirement that T must be in a local relation with v. Hence, in order to resolve a situation in English where T does not have a vP complement, an instance of v is introduced and merged onto T. Assume that South Saami satisfies T's selectional requirements not by introducing a v, but rather by raising T to Neg, which – recall – is a verb, hence strictly speaking a v. Thus, in (20), the requirement that T is in an immediately local relationship with v is satisfied. However, now a potential problem arises. If head movement has the effect of adjoining the moved head to left of the target, we arrive at (20), which gives us the wrong ordering of T and Neg-v:

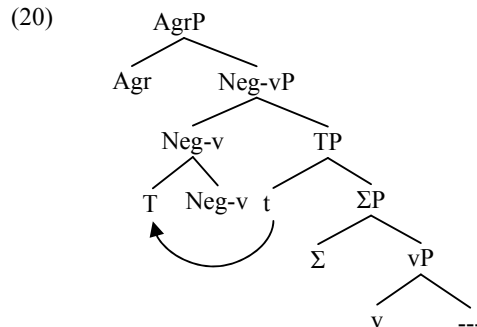

Either we have to assume that T may right-adjoin to Neg-v, or that there is a morphophonological rule responsible for aligning Neg-v with the left edge of the morphological word (see Embick & Noyer 2001). Without further argument, I assume the latter. The next step in the derivation involves raising of the complex Neg-v head to Agr, yielding (21):

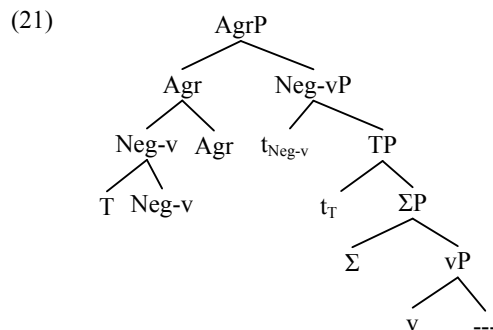

To summarize, in this section I have argued that the structure of negated clauses in South and North Saami are structurally identical. The crucial factor that determines the morphosyntactic distribution of verbal inflection in the two languages is whether or not verb raising to T applies. In raising contexts, the negation auxiliary never expresses tense, but only agreement. The only case where verb raising does not take place for independent reasons is found with finite main verbs in South Saami. In exactly these cases, the negation serves as the host for the tense suffix.

#### 4. Concluding Remarks

This paper has shown that there is a strong correlation between on the one hand the strategy employed in satisfying the relation between the verb and T and on the other, the morphosyntactic complexity of the negation auxiliary in two Saami languages. Thus we have seen that a seemingly morphological issue has been reduced to an independently motivated syntactic distinction



between these languages. Furthermore, once we take this syntactic difference into account, we have paved the way for a unified treatment of the morphosyntax of negation in Saami.

## References

- Bobaljik, Jonathan David. 1995. Morphosyntax: the syntax of verbal inflection, MIT: Ph.D. Diss.
- Embick, David, & Rolf Noyer. 2001. Movement operations after syntax. *Linguistic Inquiry*, **32**.4:555-595.
- Emonds, Joseph. 1978. The verbal complex V'-V in French. *Linguistic Inquiry*, **9**.2:151-175.
- Laka, Itziar. 1990. Negation in syntax: On the nature of functional categories and projections, MIT: Ph.D. Diss.
- Mitchell, Erika. 2006. The morpho-syntax of negation and the positions of NegP in the Finno-Ugric languages. *Lingua*, **116**.3:228-244.
- Pollock, Jean-Yves. 1989. Verb movement, universal grammar, and the structure of IP. *Linguistic Inquiry*, **20**.3:365-424.

Mikael Vinka  
Umeå University  
Saami Studies  
901 86 Umeå  
Sweden  
mikael.vinka@samiska.umu.se

# Unifying Selective Islands Under $\nu$

Christopher A. Warnasch

The Graduate Center of the City University of New York

## 1. Introduction

Factive verbs, manner of speaking verbs, and “light” verbs taking complex noun phrase complements show parallel extraction asymmetries. The complement of each type of verb is a selective island, from which only specific phrases are extractable. The same constraints on extraction are seen with other types of selective islands, such as negation or *wh*-islands, yet the islands discussed in this paper are “open,” meaning that they lack overt interveners. The aim of this paper is to present a unified account of these constructions, tying them to the feature [+spf] (specific) on matrix  $\nu$ . While  $\nu$  Agrees with a different [+spf] goal in each case, the presence of this feature has an identical effect across the three types of islands. Matrix  $\nu$  is a discriminator, feature-clashing with and blocking extraction of [–spf] phrases.

This paper is organized as follows. Section 2 presents the relevant data, demonstrating that these three selective island constructions should be treated uniformly. Section 3 highlights approaches to selective islands with overt interveners, with an emphasis on the role of specificity, and it addresses the question of whether the same account can be brought to bear on open selective islands. Section 4 justifies an account implicating matrix  $\nu$  in the specificity requirement on extraction. Sections 5, 6, and 7 focus on the mechanics of such an account in cases of factive verbs, manner of speaking verbs, and light verbs taking complex NP complements, respectively. Finally, Section 8 concludes by proposing that the differences among non-island, selective island, and strong island complements may be reduced to a typology of (matrix)  $\nu$ .

## 2. The Data

There are identical patterns of (un)grammatical extraction among CP complements of factive verbs (*confirm*, *regret*, *deny*, *admit*, *discover*, *learn*, *verify*, *realize*, *know*...), manner of speaking (MOS) verbs (*mumble*, *whisper*, *snort*, *hiss*, *holler*, *grunt*...) and light verbs taking complex noun phrase

complements (light CNP verbs) (*make the claim, give/get/have the impression, give/get/have the feeling, have the idea...*):

- (1)
- a. Who<sub>i</sub> did you confirm/mumble/make the claim that he invited  $t_i$ ?
  - b. What<sub>i</sub> did you confirm/mumble/make the claim that they did  $t_i$ ?
  - c. Out of which bag<sub>i</sub> did you confirm/mumble/make the claim that she took the money  $t_i$ ?
  - d. Which bag<sub>i</sub> did you confirm/mumble/make the claim that she took the money out of  $t_i$ ?
  - e. Which way<sub>i</sub> did he confirm/mumble/make the claim that she drove home  $t_i$ ?
- (2)
- a. \*How much headway<sub>i</sub> did you confirm/mumble/make the claim  $t_i$  would have to be made?
  - b. \*How many pounds<sub>i</sub> did you confirm/mumble/make the claim that the baby weighed  $t_i$ ?
  - c. \*Out of which bag<sub>i</sub> did you confirm/mumble/make the claim that he let the cat  $t_i$ ? (idiomatic reading)
  - d. \*Which bag<sub>i</sub> did you confirm/mumble/make the claim that he let the cat out of  $t_i$ ? (idiomatic reading)
  - e. \*How<sub>i</sub> did he confirm/mumble/make the claim that she drove home  $t_i$ ?

The proper generalization is that only specific phrases are extractable, regardless of argument status. This contrasts with extraction from bridge verb complements (3), which are not islands and allow all extraction, and with extraction from lexical CNP verb complements (4), which are strong islands:

- (3)
- a. Who<sub>i</sub> did you say/think/repeat that he invited  $t_i$ ?
  - b. What<sub>i</sub> did you say/think/repeat that they did  $t_i$ ?
  - c. Out of which bag<sub>i</sub> did you say/think/repeat that she took the money  $t_i$ ?
  - d. Which bag<sub>i</sub> did you say/think/repeat that she took the money out of  $t_i$ ?
  - e. Which way<sub>i</sub> did he say/think/repeat that she drove home  $t_i$ ?
  - f. How much headway<sub>i</sub> did you say/think/repeat  $t_i$  would have to be made?
  - g. How many pounds<sub>i</sub> did you say/think/repeat that the baby weighed  $t_i$ ?
  - h. Out of which bag<sub>i</sub> did you say/think/repeat that he let the cat  $t_i$ ?
  - i. Which bag<sub>i</sub> did you say/think/repeat that he let the cat out of  $t_i$ ?
  - j. How<sub>i</sub> did he say/think/repeat that she drove home  $t_i$ ?
- (4)
- a. \*Who<sub>i</sub> did you hear the claim that he invited  $t_i$ ?
  - b. ?What<sub>i</sub> did you hear the claim that they did  $t_i$ ?
  - c. \*Out of which bag<sub>i</sub> did you hear the claim that she took the money  $t_i$ ?

- d. \*Which bag<sub>i</sub> did you hear the claim that she took the money out of  $t_i$ ?
- e. \*Which way<sub>i</sub> did he hear the claim that she drove home  $t_i$ ?
- f. \*How much headway<sub>i</sub> did you hear the claim  $t_i$  would have to be made?
- g. \*How many pounds<sub>i</sub> did you hear the claim that the baby weighed  $t_i$ ?
- h. \*Out of which bag<sub>i</sub> did you hear the claim that he let the cat  $t_i$ ?
- i. \*Which bag<sub>i</sub> did you hear the claim that he let the cat out of  $t_i$ ?
- j. \*How<sub>i</sub> did he hear the claim that she drove home  $t_i$ ?

The status of (4b) will be discussed in section 7. The important point made by the data above is that extractability from the islands under discussion depends on specificity, both in the case of arguments and adjuncts.

### 3. Selective Islands and Specificity

Unlike strong islands, which are opaque to all extraction, selective islands are transparent to extraction of certain types of phrases. As summarized in Szabolcsi & den Dikken (1999) and Szabolcsi (2006), a number of different types of selective islands have been identified in the literature, with several theories about what constitutes the type of phrase that can survive extraction:

- Arguments (Huang 1982, Lasnik & Saito 1984, Chomsky 1986)
- Referential phrases (Rizzi 1990)
- D(iscourse)-linked phrases (Cinque 1990)
- Case-marked phrases (Manzini 1992)
- Specific phrases (Starke 2001)

According to Starke (2001), who focuses on islands with overt interveners, only Relativized Minimality (Rizzi, 1990) and a more refined feature geometry are needed to explain selective islands. Phrases that survive extraction from selective islands all carry an existential presupposition, linked to specificity. If specificity is represented as  $\beta$ , a specific phrase can “hop over” a non-specific intervener (5a), and no RM violation occurs. However, a non-specific phrase, lacking  $\beta$ , encounters a like intervener, and thus an RM violation arises (5b):

- (5) a.  $\alpha\beta \dots \alpha \dots \alpha\beta$   
 b. \* $\alpha \dots \alpha \dots \alpha$

The relevant feature geometry which Starke proposes is such that the specificity feature  $\beta$  is contained within  $\alpha$ . In this way, attraction/Agreement for  $\beta$  is able to “reach into” the feature geometry at a point that excludes  $\alpha$ . This has the effect of giving specific extraction a route that avoids like interveners. Starke adopts a notion of specificity related to D-linking (Pesetsky 1987), and to the

familiarity-based specifics of Enç (1991). So, a phrase that is unextractable from a selective island in one context can be made extractable in another context. This holds even for aggressively non D-linked phrases, which may be extractable from a selective island, such as negation, in the appropriate context where a specific answer is presupposed (Szabolcsi and Zwarts 1993). For example, if a person is seen rifling at length through a dictionary, an onlooker may finally ask:

(6) What the hell do you still not know how to spell?

As demonstrated in Section 2, this specificity generalization holds for the complements of the open islands under discussion as well. It is also the case that otherwise ungrammatical extraction from an open selective island is salvageable in the appropriate context, where a specific answer is presupposed:

- (7) a. \*On which bus<sub>i</sub> did you realize that you left your wallet  $t_i$ ? (out of the blue)  
 b. \*Who the hell<sub>i</sub> do you regret that you invited  $t_i$ ? (out of the blue)  
 c. You took three of them today, so on which bus<sub>i</sub> did you realize that you left your wallet  $t_i$ ?  
 d. All the guests seem pretty great to me, so who the hell<sub>i</sub> do you regret that you invited  $t_i$ ?

However, these open islands differ from other selective islands in that they lack overt interveners. Without overt interveners, the specificity effects in open islands cannot be attributed to an RM violation. The current proposal is that the culprit is instead matrix  $v$ , carrying the feature [+spf] in factive, MOS and light CNP contexts. The presence of this feature on matrix  $v$  acts as a filter, and only phrases that match the [+spf] feature content are extractable.

#### 4. Why Matrix $v$ ?

The mechanics of this account will be addressed in Sections 5, 6, and 7. First, it is important to justify a proposal that turns to matrix  $v$  for an explanation of the specificity requirement on extraction from open islands. First, there does not seem to be a ban on any particular type of phrase occupying Spec,CP in free relative complements of factive, MOS, or light CNP verbs, suggesting that the blocking effect does not come into play in the complement clause:

- (8) a. You said/confirmed/whispered/made the claim [<sub>CP</sub> who the candidate is.]  
 b. You said/confirmed/whispered/made the claim [<sub>CP</sub> when the candidate was chosen.]

- c. You said/confirmed/whispered/made the claim [<sub>CP</sub> how the candidate was chosen.]
- d. You said/confirmed/whispered/made the claim [<sub>CP</sub> how many pounds the candidate weighed.]

Second, from a Minimalist perspective (Chomsky 1995, 2000, 2001) matrix *v* is the next highest probe that could be implicated in driving – or blocking – movement. Thus, without proposing extra functional projections between the CP complement and the matrix verb, matrix *v* is the only candidate that can be involved in driving extraction of any kind, specific or not.

Third, independently established facts related to *v* to justify an account that identifies it as the locus of distinction between grammatical [+spf] and ungrammatical [-spf] extraction. Cross-linguistically, *v* is known to be associated with specificity. In Tagalog, when *v* Agrees with a DP argument (in italics), verbal morphology indicates this Agreement, and that “shifted” argument receives a specific interpretation (Rackowski & Richards, 2005):

- (9) a. N-agbigay *ang magsasaka* ng bulaklak sa kalabaw.  
NOM.asp-give ANG farmer CS flower DAT water.buffalo  
'*The farmer* gave a flower to the water buffalo.'
- b. I-b-in-igay ng magsasaka *ang bulaklak* sa kalabaw.  
OBL.asp-give CS farmer ANG flower DAT water.buffalo  
'A/*The farmer* gave *the flower* to the water buffalo.'

It has also been argued (Diesing 1996, Thráinsson 2001) that in Germanic, objects that are to receive a specific interpretation must raise to Spec,vP:

- (10) a. Nemandinn las bókina ekki.  
student.the.NOM read book.the.ACC not  
'The student didn't read the book.' (Thráinsson 2001)
- b. Han las ekki bækur.  
he read not books  
'He didn't read books.' (Diesing 1996)

Thus, there are several reasons to turn to matrix *v* for an explanation of the extraction asymmetries demonstrated in Section 2. The following sections will now focus on the mechanics involved in extraction from each type of selective island under discussion.

## 5. Factive Islands

Previous accounts of factive islands treat all extraction on a par or make an argument-adjunct distinction without consideration of specificity. They are also forced to identify extra syntactic structure within or above the complement CP:

Kiparsky & Kiparsky (1970)	Factive verbs select an NP complement headed by the abstract noun FACT, which in turn selects a complement S. All extraction is ruled out by the Complex Noun Phrase Constraint (Ross, 1967/1986)
Melvold (1986)	Factive verbs select clausal complements with empty operators in Spec,CP. The filled “escape hatch” blocks extraction.
Progovac (1988)	Proposes an empty operator approach for inherently negative verbs such as <i>doubt</i> or <i>deny</i> .
Manzini (1992)	Similarly proposes an empty operator in Spec,CP.
de Cuba (2002)	Proposes a functional projection CP <sub>VS</sub> in the complement of bridge verbs. The complement CP is attracted into Spec,CP <sub>VS</sub> , and the entire embedded clause (including adjuncts) is in a left-periphery position, visible to further movement operations. This contrasts with non-bridge complements.

The actual picture of extraction from factive complements is more complex. It is not the case that all extraction is blocked, nor is it the case that all argument extraction is allowed while all adjunct extraction is blocked. The right generalization, as demonstrated in Section 2, is captured if factive matrix *v* acts as a specificity filter. This filtering effect proceeds as follows. Factive *v* Agrees with its complement CP for the feature [+spf], and this encodes the semantic notion of presupposition of that CP, which is a distinguishing characteristic of factive complements. This Agree relationship is in the spirit of Rackowski & Richards (2005), who suggest that non-bridge *v* can Agree for a  $\phi$ -feature associated with DP and CP.

(11) [TP You [VP [<sub>v</sub> confirmed [+spf]] [CP [C that [+spf]] Paul invited Bill]]]

In extraction contexts, after matrix  $v$  Agrees with CP for the feature [+spf], a second edge feature moves the extractee into Spec, $v$ P. But that extractee must not clash with the [+spf] feature content of  $v$ . Following Pesetsky and Torrego (2001), the [+spf] feature remains active until completion of its phase, thus acting as a filter against [-spf] phrases in Spec, $v$ P.

Factive islands therefore differ from closed selective islands in that the feature [+spf] is at work at a different point in the derivation. Following Starke (2001), in a closed island, such as a wh-island, the [+spf] phrase is able to “hop over” a [-spf] intervener in Spec of the complement CP, and no RM violation occurs. In an open island, though, a [-spf] phrase is able to make it into Spec,CP of the embedded clause, but encounters problems at its next touch-down in matrix Spec, $v$ P, where it clashes with the [+spf] feature content of the probe  $v$ .

## 6. Manner of Speaking Islands

Unlike factive islands, MOS islands are characterized by semantic complexity instead of presupposition. If presupposition of factive complements is encoded through an Agree relationship between matrix  $v$  and CP, a different type of Agree relationship must be at work in MOS constructions, where no such presupposition exists. Hale and Keyser (2002) analyze other semantically complex verbs such as *red* as examples of conflation, where an A head merges with the verbal morphology on V:

- (12) [<sub>VP</sub> the sky [<sub>V</sub> [<sub>V</sub> -en] [<sub>A</sub> red]]]]

Another relevant characteristic of MOS verbs is that they have identical nominal counterparts, and these constructions may take CP complements:

- (13) a. He let out a yell that everyone was against him.  
b. She gave a groan that she would comply.

Pesetsky (1995) points out that these homophonous forms may suggest that MOS verbs are denominal. Thus, following the derivation in (12), an MOS verb is the result of a derivation whereby an underlying noun is conflated onto an abstract V head (14a). Extraction then targets a CP associated with that noun rather than a verbal complement (14b.)

- (14) a. [<sub>VP</sub> [<sub>V</sub> SAY] [<sub>N</sub> whisper]]  
b. [<sub>TP</sub> Ron [<sub>VP</sub> [<sub>V</sub> whispered<sub>i</sub>] [<sub>NP</sub>  $t_i$  [<sub>CP</sub> that he had given Frank the binoculars]]]]]



Evidence that the apparent MOS verbal complement is associated with an underlying noun comes from the fact that MOS complements, unlike bridge or factive complements, are not passivizable.

- (15) a. That Ron gave Frank the binoculars was regretted/admitted by all.  
 b. That Ron gave Frank the binoculars was said/repeated by all.  
 c. \*That Ron gave Frank the binoculars was snorted/shouted by all.

This is unexpected if the embedded CP in (15c) is the complement of a garden variety transitive verb. At first glance it may even be unexpected if the CP is the complement of a noun that is conflated onto an abstract V head, given the Government Transparency Corollary (Baker, 1988.) The GTC states that the complement of an incorporated item becomes the complement of the structure formed by incorporation. Therefore, if the CP in (15c) were the complement of N, it is expected to become the derived complement of V after N-incorporation, and therefore passivizable. However, following Grimshaw (1990), MOS NPs denote simple events or results and therefore do not have an argument structure. So MOS “complement” CPs are in fact not complements of the underlying nominal constructions, and cannot therefore become derived complements of MOS verbs. The proposed derivation then captures the semantic complexity, homophonous verbal and nominal forms, and unavailability of passivization characteristic of MOS constructions.

This derivation also suggests a goal with which matrix MOS *v* may Agree for the feature [+spf]: a null [+spf] DP complement above the conflated noun:

- (16) [<sub>TP</sub> You [<sub>VP</sub> [<sub>v</sub> mumbled<sub>i</sub>] [<sub>+spf</sub>] [<sub>DP</sub> [<sub>+spf</sub>] [<sub>NP</sub> *t*<sub>i</sub> [<sub>CP</sub> that Paul was a jerk]]]]]]

There are incorporation facts that allow for such an analysis. Examples from Mohawk and Nahuatl (Baker, 1988) show that incorporated nouns may retain a specific interpretation, so it is reasonable to assume that they have been incorporated over a null [+spf] DP:

- (17) a. Nó:nv akwé: yo-státhv nó:-nvhst-e sok nú:wa v-tsaka-nvhst-arú:ko  
 when all 3N-dry pre-corn-suf then now fut-1pS-corn-take.off  
 ‘When the corn was completely dry, it was time to shell it (the corn)’  
 b. Ya’ ki-kočillo-tete’ki panci  
 he 3sS/3sO-knife-cut bread  
 ‘He cut the bread with it (the knife).’

Of course, these examples demonstrate that incorporated nouns *can* be [+spf], not that they *must* be [+spf], which is required of underlying MOS nouns under

the current proposal. But even with an overt definite DP, a specific reading is not guaranteed, as in (18a) below. Intuitively, it may be the case that the CP serves to restrict the underlying MOS noun and render it specific, but it is not the case that all restriction leads to specificity, as shown in (18b).

- (18) a. The musk ox is a large shaggy animal that lives in the tundra.  
 b. Reconstruction will mostly be paid for by the working family that lives in poorer neighborhood.

Nonetheless, if a case can be made for conflation of a null specific DP in MOS constructions, an account falls out that links MOS verbs with factive verbs, and the parallel extraction asymmetries are explained.

## 7. Light CNP Islands

Turning now to the final type of selective island under discussion, one interesting characteristic of light CNP complements is that they cannot be replaced by a pronoun (19a-b). This differs from lexical CNP complements, which can (19c-d):

- (19) a. \*They made the claim that Bill was unfairly fired, and we made it, too.  
 b. \*Mary gave me the impression that the book was unreadable, and Bill gave it to me, too.  
 c. They heard the claim that that Bill was unfairly fired, and we heard it, too.  
 d. Mary gave me the book that the professor recommended, and Bill gave it to me, too.

Following Postal (1993), this “antipronominal context” suggests that light CNP verbs, unlike lexical CNP verbs, do not Agree with their DP complements for Case. Instead, the proposal is that Agree with DP for the feature [+spf]:

- (20) [<sub>TP</sub> You [<sub>VP</sub> [<sub>v</sub> made [+spf]] [<sub>DP</sub> the [+spf] claim [<sub>CP</sub> that Paul was a jerk]]]]

Note that this Agreement contrasts with the Agreement proposed for factive *v*. Factive *v* Agrees with its CP complement for the feature [+spf], and that complement is interpreted as a presupposition. There is no such presupposition in the case of MOS or light CNP complements, and this is expected, given that in these cases matrix *v* Agrees with DP, null in the case of MOS verbs, and overt in the case of light CNP verbs. But as with factive and MOS verbs, the presence

of the feature [+spf] on matrix  $v$  in light CNP contexts acts as a discriminator. Only [+spf] phrases do not clash with the feature content of  $v$ , and only they are extractable from light CNP complements, as demonstrated in Section 2.

The contrast between Agreement for [+spf] between light  $v$  and DP on the one hand, and Agreement for both [+Acc] and [+spf] between lexical  $v$  and DP on the other, leads to a few predictions. Other locality constraints are likely to be at work in lexical CNP contexts, but degrees of ungrammaticality are expected based on the Case and specificity status of the extractee. In particular, [+Acc +spf] phrases should be (somewhat) extractable from lexical CNP complements, as first suggested in example (4b) and shown again in (21a). However, all other combinations of values for those features should not be extractable: [-Acc +spf] in (21b) and (21c), [-Acc -spf] in (21d), and [+Acc -spf] in (21e):

- (21) a. ?which cat<sub>i</sub> did you report the claim that Mark mistreated  $t_i$ ?  
 b. \*which way<sub>i</sub> did you report the claim that Deanna had left  $t_i$ ?  
 c. \*who<sub>i</sub> did you report the claim that Mark said  $t_i$  left early?  
 d. \*how<sub>i</sub>/when<sub>i</sub>/why<sub>i</sub> did you report the claim that Deanna had left  $t_i$ ?  
 e. \*which cat<sub>i</sub> did you report the claim that Mark let  $t_i$  out of the bag?

In light CNP contexts the relevant feature is [+spf], and Case does not come into play, so specific phrases of any Case (including phrases with no Case) are expected to be extractable (22a-c) while non-specific phrases are not (22d-e):

- (22) a. which cat<sub>i</sub> did you make the claim that Mark mistreated  $t_i$ ?  
 b. which way<sub>i</sub> did you make the claim that Deanna had left  $t_i$ ?  
 c. who<sub>i</sub> did you make the claim that Mark said  $t_i$  left early?  
 d. \*how<sub>i</sub>/\*when<sub>i</sub>/\*why<sub>i</sub> did you make the claim the Deanna had left  $t_i$ ?  
 e. \*which cat<sub>i</sub> did you make the claim that Mark let  $t_i$  out of the bag?

## 8. Conclusion

This paper has shown that the extraction facts among three apparently diverse categories of verbs – factive, MOS, and light CNP verbs – are parallel, and the proper generalization is not based on an argument/adjunct distinction, but rather on a [ $\pm$ spf] distinction. This feature unifies the analyses of all three constructions, although they differ in their syntactic structure and in the nature of the goal involved in the [+spf] Agree relation into which matrix  $v$  enters. In factive constructions, matrix  $v$  Agrees for the feature [+spf] with the complement CP, and this Agreement encodes the presupposition of that CP. In MOS constructions, matrix  $v$  Agrees for the feature [+spf] with a null DP complement. Thus, the DP itself is [+spf], but the CP complement is not a

presupposition. Finally, matrix  $v$  in light CNP constructions Agrees for the feature [+spf] with an overt DP complement. In all three cases, extraction of a [-spf] phrase fails due to a feature clash with the feature [+spf] on matrix  $v$ .

The analysis presented in this paper brings three types of selective islands together under a single explanation, and that explanation does not rely on extra syntactic projections or empty operators, but rather on cross-linguistically attested properties of  $v$ . This analysis explains why some arguments are not extractable from the complements of factive, MOS, or light CNP complements, and at the same time it explains why some adjuncts are extractable. It also sheds light on issues such as the unavailability of passivization of MOS complements and the asymmetries between lexical and light CNP verbs. Finally, this analysis leads to a typology of  $v$ , which reduces the differences between bridge (non-island) constructions, selective island constructions, and lexical CNP (strong island) constructions to the nature of matrix  $v$  involved in each construction:

(23)	Type of $v$	[+Case]	[+spf]	Agrees with
	bridge			
	factive		√	CP
	MOS		√	(null) DP
	light CNP		√	DP
	lexical CNP	√	√	DP

## References

- Baker, M. 1988. *Incorporation*. Chicago: University of Chicago Press.
- Chomsky, N. 1986. *Barriers*. Cambridge: MIT Press.
- Chomsky, N. 1995. *The Minimalist Program*. Cambridge: MIT Press.
- Chomsky, N. 2000. Minimalist inquiries: the framework. In *Step by Step: Essays on minimalist syntax in honor of Howard Lasnik*. R. Martin, D. Michaels, & J. Uriagereka eds. Cambridge: MIT Press.
- Chomsky, N. 2001. Derivation by phase. In *Ken Hale: A life in language*. Michael Kenstowicz, ed. 1-52. Cambridge: MIT Press.
- Cinque, G. 1990. *Types of  $\bar{A}$ -Dependencies*. Cambridge: MIT Press.
- De Cuba, C. 2002. *A phase-derivational analysis of limited embedded V2 in mainland Scandinavian*. Qualifying Paper: Stony Brook University, Stony Brook, NY.
- Diesing, M. 1996. Semantic variables and object shift. In *Studies in comparative Germanic Syntax II*. Thráinsson, H., Epstein D., and Peter, S. eds. 66-84. Dordrecht: Kluwer.
- Enç, M. 1991. "The Semantics of Specificity," *Linguistic Inquiry*, 22. 1-25.
- Grimshaw, J. 1990. *Argument Structure*. Cambridge: MIT Press.
- Hale, K. & Keyser, J 2002 *Prolegomenon to a Theory of Argument Structure*. Cambridge: MIT Press.

- Huang, C.T. James 1982. *Logical Relations in Chinese and the Theory of Grammar*. Doctoral Dissertation, MIT.
- Kiparsky, P. & Kiparsky, C. 1970. Fact. In *Progress in Linguistics*, M. Bierwisch & K. Heidolph eds. 143-173. The Hague: Mouton.
- Lasnik, H. & Saito, M. 1984. "On the nature of proper government." *Linguistic Inquiry*. **15**. 235-289.
- Manzini, M. 1992. *Locality: A Theory and Some of Its Empirical Consequences*. Cambridge: MIT Press.
- Melvold, J. 1986. *Factivity and Definiteness*. Manuscript, MIT.
- Pesetsky, D. 1995. *Zero Syntax II*. Manuscript, MIT.
- Pesetsky, D. 1987. Wh-in-Situ: Movement and unselective binding. In *The Representation of (In)definiteness*. Reuland, E. & ter Meulen, A., eds. 98-129. Cambridge: MIT Press.
- Pesetsky, D. & Torrego, E. 2001. T-to-C Movement: Causes and Consequences. In *Ken Hale: A Life in Language*. Kenstowicz, M., ed. Cambridge: MIT Press. 355-426.
- Postal, P. 1993 "Parasitic Gaps and Across-the-Board Phenomenon." *Linguistic Inquiry*. **24**. 735-754.
- Progovac, L. 1988. *A Binding Approach to Polarity Sensitivity*. Doctoral dissertation, University of Southern California.
- Rackowski, A. & Richards, N. 2005. "Phase Edge Extraction: A Tagalog Case Study." *Linguistic Inquiry*. **36**. 565-599.
- Rizzi, L. 1990. *Relativized Minimality*. Cambridge: MIT Press.
- Ross, J. 1967. *Constraints on Variables in Syntax*. Unpublished dissertation, MIT. Published as *Infinite Syntax!* 1986. Norwood, NJ: Ablex Publishing Corporation.
- Starke, M. 2001. *Move Dissolves into Merge: a Theory of Locality*. Doctoral Dissertation, Université de Genève.
- Szabolcsi, A. 2006. "Strong and Weak Islands." In *The Blackwell Companion to Syntax*, Martin Everaert & Henk van Riemsdijk eds. Oxford: Blackwell.
- Szabolcsi, A. & den Dikken, M. 1999. *Islands*. *GLOT International* 4/6.
- Szabolcsi, A. & Zwarts, F. 1993. "Weak islands and an algebraic semantics of scope taking." *Natural Language Semantics*. **1**. 235-284.
- Thráinsson, H. 2001. Object shift and scrambling. In *A Handbook of contemporary syntactic theory*. Baltin, M., and Collins, C. eds. 148-202. Oxford: Blackwell.

Christopher A. Warnasch  
The Graduate Center of the City University of New York  
365 Fifth Avenue, New York, NY, 10016  
cwarnasch@gc.cuny.edu

# Building Resultatives in Icelandic

Matthew Whelpton  
University of Iceland

## 1 Introduction

This paper considers Kratzer's (2005) analysis of resultatives such as the German example in (1).

- (1) die Teekanne leer trinken  
the teapot empty drink  
"to drink the teapot dry"

It considers the implications for this analysis of data from Icelandic as reported in Whelpton (2006).

Kratzer offers an elegant attempt to bring together a radical version of the raising hypothesis for resultatives (cf. Hoekstra 1988) with the typological correlation observed by Snyder (1995: , 2001) between resultative formation and root compounding. The account is also unusual in offering an explicit formal semantic account alongside the syntax, as well as an explicit discussion of the metaphysics of causation. As will prove to be critical later, Kratzer (2005: 179) restricts her discussion to **adjectival resultatives**: "Inclusion of directionals in discussions of resultatives has obscured important generalizations that emerge clearly once we restrict our enterprise to resultatives built from adjectives."

## 2 Kratzer's analysis

The first step in Kratzer's analysis is shown in Figure 1.

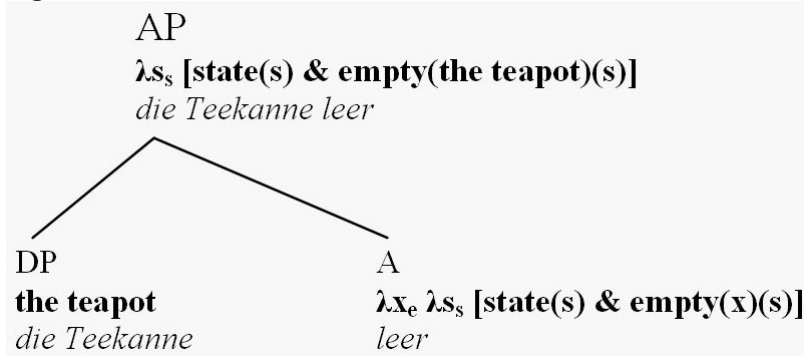
**Figure 1: small clause formation**

The DP *die Teekanne* “the teapot” is merged with the adjective *leer* “empty”; the DP is interpreted as the holder of the state denoted by the adjective. The resulting AP is a property of states. Within Kratzer’s compositional semantics this is the equivalent of a small clause in Hoekstra’s account. The DP cannot check Case in this configuration; for this to happen, the AP must be merged as the complement of V so that the DP can “raise to object” and check its Case in the functional projection of the verb.

Merging AP with V at this point however will produce a semantic problem, as shown in Figure 2.

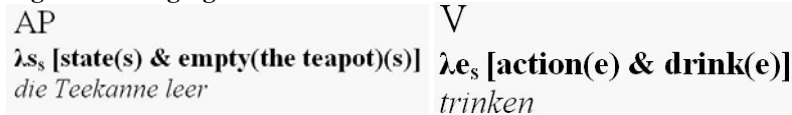
**Figure 2: Merging AP with V**

The AP *die Teekanne leer* “the teapot empty” is a property of states; the V *trinken* “drink” is a property of actions. An attempt to combine these by identifying *s* with *e* will produce as a denotation the empty set (nothing is both a state and an event). To solve the problem, the AP denotation must be converted to an event property denotation exactly like that of V.

Kratzer follows Bittner (1999) in assuming that this conversion occurs by a process of causativisation, as the resultative does indeed have a causative meaning (the action denoted by the main verb, e.g. the drinking, causes – or more precisely in Kratzer’s terms, is equivalent to the causation of – the adjectival state, e.g. the teapot being empty). However, she rejects Bittner’s purely compositional type-shift rule on the grounds that rules of composition should be content-neutral and only individual formatives should be allowed to introduce “lexical” content (such as a description of causation). Instead, she argues that the

causativisation rule is triggered by a zero affix which merges with the AP and which attracts and compounds with the adjectival head. This is shown in Figure 3.

**Figure 3: Compounding of A and CAUSE**

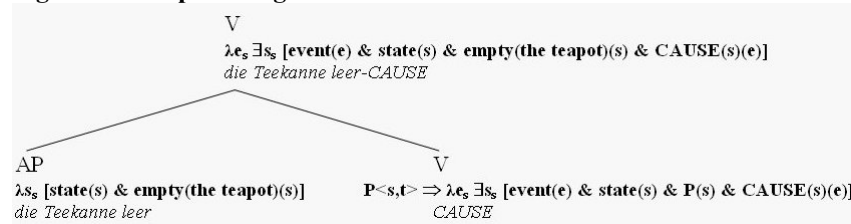

AP is merged with a zero verbal head which is a type-shifting causative affix. It converts the AP property of states into a property of events, such that the relevant event is an event in which the adjectival state is caused to obtain. Syntactically, A raises to the causative V and compounds with it. This new compound V has a denotation which is suitable for merger with the main verb, as shown in Figure 4.

**Figure 4: Serialisation of causative V and main V**

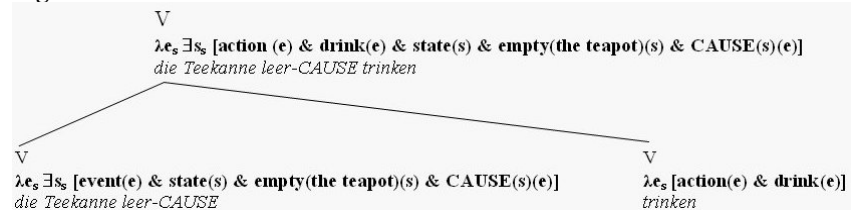

Within Kratzer's system, the rule composing the two denotations is a serialisation rule. It involves simple unification of the two predicates by identification of variables and conjunction. This process requires that the serialised predicates have identical denotation types. As both predicates here must be simple event properties, the main verb must be intransitive (external arguments in Kratzer's system are added by higher functional structure). This semantic requirement also provides a syntactic solution to a syntactic problem: Case-checking for the complement of the Adjective. The complement of A can raise to be object of main V.

This account is based on two important hypotheses.

#### Hypothesis 1

All resultative adjectives are compounded with a derivational CAUSE affix and then serialised with the verb THEREFORE adjectives cannot have inflectional structure.



### Hypothesis 2

All verbs appearing with adjectival resultatives behave as unergatives – transitives and unaccusatives do not occur with adjectival resultatives.

This paper will consider each hypothesis in turn with respect to data from Icelandic.

## 3 Hypothesis 1 – The Uninflected Adjective Hypothesis

Kratzer cites Fabricius Hansen (p.c.) for pointing out problems with Hypothesis 1 from Norwegian, where adjectives can bear an inflectional affix (neuter agreement). This paper elaborates that challenge with data from Icelandic where predicational adjectives inflect richly.

Nouns in Icelandic inflect according to Gender (Masculine (m), Feminine (f) and Neuter (n)), Case (Nominative (N), Accusative (A), Dative (D) and Genitive (G)) and Number (Singular (S) and Plural (P)).

(2) hesta\_mAP = Masculine, Accusative, Plural

Not only attributive adjectives but also predicational adjectives agree with Nouns in Number, Gender and Case.

- (3) Hestarnir eru svartir. (Copular predication)  
horses\_the\_mNP are black\_mNP  
“the horses are black”
- (4) Mér finnst hestar sætir. (Small Clause Complement)  
I\_D find horses\_mNP cute\_mNP  
“I think horses cute”
- (5) Við kláruðum kjötbollurnar kaldar. (Depictive predication)  
We\_N finished meatballs\_the\_fAP cold\_fAP  
“We finished the meatballs cold”
- (6) Ég kýldi lögguna kalda. (Resultative predication)  
I\_N punched cop\_the\_fAS cold\_fAS  
“I punched the cop out cold”

Resultative adjectives with full predicational inflection can be found in Icelandic with each of the major verb classes: transitive, unergative and unaccusative.

- (7) Járnsmiðurinn hamraði málminn flatan. (transitive verb)  
blacksmith\_the hammered metal\_the\_mAS flat\_mAS  
“the blacksmith hammered the metal flat”
- (8) Dóra æpti sig hása. (unergative verb)  
Dóra screamed herself\_fAS hoarse\_fAS  
“Dóra screamed herself hoarse”

- (9) Hann fraus fastur í ísnum. (unaccusative verb)  
 he\_mNS froze stuck\_mNS in ice\_the  
 “he froze stuck in the ice”

Recall that in Kratzer’s account the adjective cannot bear inflection because it is compounded with a (zero) affix and must therefore be bare and uninflected (derivational compounding occurs before inflectional agreement). Despite the full agreement on resultative adjectives in Icelandic, it is nevertheless the case that when overt compounding does occur, as in the formation of adjectival passives which incorporate resultative adjectives, then the resultative adjective must indeed be bare of inflection.

- (10) svartlitaður  
 black-coloured  
 (11) þunnsneiddu sveppirnir  
 thin-cut mushrooms\_the  
 (12) fínmuldu piparkornin  
 fine-ground peppercorns\_the  
 (13) hreinskrúbbuðu pönnurnar  
 clean-scrubbed pans\_the  
 (14) mjúkbrædda súkkulaði  
 soft-melted chocolate

It is therefore clear that compounding behaves exactly as Kratzer expects but that adjectives in a simple resultative construction do not behave like compounded adjectives. The hypothesis that resultative adjectives must be uninflected therefore fails for Icelandic.

Kratzer dismisses some counterexamples to her approach by observing that adjectives can be used adverbially and that adverbial uses are not truly resultative and not therefore genuine counterexamples. Such an observation is certainly relevant to compounded examples like (12), where the English equivalent would use an explicitly adverbial form.

- (15) finely-ground peppercorns

In fact, Icelandic does indeed make adverbial use of adjectives with resultative-like readings, especially in examples like (12); however, in such cases, the adverbial function triggers a default agreement form (neuter accusative singular) rather than a full predicational agreement form.

- (16) Hann muldi piparkornin fínt.  
 he ground peppercorns\_the\_nAP fine\_nAS  
 “he ground the peppercorns finely”

- (17) Hvítlaukurinn er saxaður nokkuð gróft  
 Garlic\_the\_mNS is chopped rather coarse\_nAS  
 “the garlic is chopped rather coarsely”

This means that the adverbial argument cannot be used to dismiss any resultative adjective which does show full predicational agreement (at least, the argument is not convincing without a more detailed elaboration of the relation between adverbial and predicational forms of the adjective in resultative-like uses).

The conclusion is that Hypothesis 1 fails for Icelandic. It is not the case that resultative adjectives in Icelandic are uninflected, even though it is the case that compounded adjectives are uninflected. Therefore the resultative construction cannot involve covert compounding of the adjective with a causative affix in the way that Kratzer describes.

#### 4 Hypothesis 2 – The Unergatives Only Hypothesis

The second hypothesis upon which Kratzer’s account is based is that only unergative verbs (and verbs which can act as unergatives by dropping their object) can participate in the resultative construction. Here Icelandic provides both challenges and support.

Resultatives with an unergative verb and reflexive object are extremely productive in Icelandic, allowing broad use within particular subclasses of verb (e.g. verbs of sound production) and also metaphorical extension (examples are based on naturally occurring examples cited in Whelpton (2006)).

- (18) Síminn getur bara hringt sig hásan.  
 phone\_the can just ring itself\_mAS hoarse\_mAS  
 “the phone can just ring itself hoarse”
- (19) að öskra, tromma, klappa og stappa sig brjálaðan  
 to scream drum clap and stamp oneself\_mAS crazy\_mAS  
 “to scream, drum, clap and stamp yourself crazy”

However, the restriction to reflexive object is extremely strong in Icelandic and I am aware of no convincing example of an unergative resultative with a disjoint reference object. Certainly standard examples in the literature are sharply ungrammatical in Icelandic.

- (20) \*Hundurinn galti hann vakinn/vakandi.  
 dog\_the barked him\_mAS awoken\_mAS/awake  
 “the dog barked him awake”
- (21) \*Háværa klukkan tifaði barnið vakið/vakandi.  
 noisy clock\_the ticked child\_the\_nAS woken\_nAS/awake  
 “The noisy clock ticked the child awake”

Examples with PP-resultatives do however occur.

- (22) [Kisan] malaði mig í svefn  
 cat\_the purred me to sleep  
 “the cat purred me to sleep”

As previous examples have shown, transitive verbs do occur straightforwardly with disjoint reference objects and adjectival predicates. This suggests that transitive verbs in the resultative construction are not in fact simply unergatives (or unergative uses) in disguise.

An apparently serious challenge to the hypothesis comes from the occurrence of unaccusative resultatives, as cited earlier.

- (23) Hann fraus fastur í ísnum.  
 he\_mNS froze stuck\_mNS in ice\_the  
 “he froze stuck in the ice”

However, when a broader range of examples is considered, Icelandic in fact provides much more direct support for the unergatives-only hypothesis than English. Most examples of adjectival resultatives with unaccusative verbs are ungrammatical.

- (24) \*Tjörnin fraus gegnheil. (AP)  
 lake-the froze solid  
 “the lake froze solid”  
 (25) ?\*Súkkulaðið bráðnaði silkimjúkt. (AP)  
 chocolate\_the\_nNS melted silky-smooth\_nNS  
 “the chocolate melted silky smooth”

If the resultative predicate is turned into a PP, the examples become grammatical.

- (26) Tjörnin fraus í gegn. (PP)  
 lake-the froze in through  
 “the lake froze through”  
 (27) Súkkulaðið bráðnaði í mjúkan klump. (PP)  
 chocolate\_the melted into soft lump  
 “the chocolate melted into a soft lump”

The problem is therefore precisely with the adjectival nature of the predicate, as Kratzer’s account predicts.

The question then becomes why unaccusative resultatives with the adjective *fastur* “stuck” are acceptable. One striking difference between *fastur* “stuck” and *gegnheil* “solid” is that *fastur* expresses a relation (a tight relation!) between one

object and another whereas *gegnheill* expresses a simple property of an object (concerning its internal consistency). This suggests that the significant distinction is not between adjectival and prepositional predicates but between qualitative and relational predicates. The unaccusative resultative apparently requires a relational element to introduce the final state. Prepositions standardly express relations and are therefore always able to act as resultative predicates. The adjective *fastur* “stuck” is relational and therefore can also occur with unaccusative verbs. However, simple qualitative adjectives like *gegnheill* “solid” lack the relevant relational element.

This would also have the advantage for Kratzer of undermining the simple relationship suggested above between full adjectival inflection and resultative status – *fastur* is fully inflected but is not a resultative property. It would also throw light on the interrelational uses of “clear of” and “free of” in resultative constructions in English.

- (28) The sailors managed to catch a breeze and ride it **clear of** the rocks.  
(Wechsler 1997: 313, ex. 315)

With respect to Hypothesis 2, Kratzer’s analysis does not account for the sharp restriction on the reference of unergative objects as opposed to transitives. Nor does it account for the well-formedness of unaccusative resultatives with *fastur*. However, it straightforwardly predicts the general ill-formedness of unaccusatives with resultative adjectives in Icelandic. And I have sketched a way of dealing with *fastur* which would eliminate it as a real counterexample to Kratzer’s account. The jury therefore remains open on this aspect of the analysis.

## 5 Conclusions and Open Questions

This paper has considered Kratzer’s analysis of the resultative with respect to data from Icelandic. It identified two key hypotheses: 1. that resultative adjectives are always involved in compounding and must therefore be bare and uninflected; and 2. that only unergative verbs (or verbs that can be used as unergatives) can participate in the adjectival resultative construction. Icelandic provides strong evidence that the first hypothesis is incorrect: resultative adjectives are fully inflected with predicational agreement morphology and in this respect they contrast with compounded adjectives which are bare and uninflected. Icelandic provides mixed evidence with respect to the second hypothesis. The sharp distinction between objects of unergatives (which must be reflexive) and object of transitives (which can be disjoint in reference) with adjectival resultatives suggests that transitive verbs in the resultative really are transitive in Icelandic and not just unergatives in disguise. However, the broad ungrammaticality of unaccusatives with adjectival (as opposed to prepositional) resultatives suggests that unaccusatives should indeed be excluded in a proper

account of the resultative construction. The single counterexample with *fastur* can be seen to confirm the general spirit of the account as this adjective is relational rather than simply qualitative and therefore more like a prepositional predicate.

However, this leaves open the general question of why a relational element is required with unaccusative resultatives and whether the relational element is introduced purely by the semantics (as rather suggested in my discussion here) or by a covert head in the syntax, echoing Kratzer's account once again. These (and related) questions remain for future research.

## References

- Bittner, M. 1999. "Concealed Causatives", *Natural Language Semantics*, 7:1-78.
- Hoekstra, T. 1988. "Small Clause Results", *Lingua*, 74:101-139.
- Kratzer, Angelika. 2005. Building Resultatives. In *Event Arguments: Foundations and Applications*, eds. Claudia Maienborn and Angelika Wöllstein, 177-212. Tübingen: Max Niemeyer Verlag.
- Snyder, William. 1995. *Language Acquisition and Language Variation. The Role of Morphology.*, Ph.D. in Linguistics, MIT.
- Snyder, William. 2001. "On the Nature of Syntactic Variation: Evidence from Complex Predicates and Complex Word-Formation", *Language*, 77:324-342.
- Wechsler, Stephen. 1997. Resultative predicates and control. In *Proceedings of the Texas Linguistics Society*, eds. Ralph C. Blight and Michelle J. Moosally, 307-321. Austin: University of Texas.
- Whelpton, Matthew. 2006. "Resultatives in Icelandic – A Preliminary Investigation", <http://ling.auf.net/lingBuzz/000292>.

# On the Interpretation and Licensing of *Shika*-NPIs in Tokyo Japanese and the Syntax-Prosody Interface\*

Hideaki Yamashita

Yokohama National University

## 1. Introduction: An Interdisciplinary Approach to Human Language Grammar

A number of recent works have shown that prosody plays a pivotal role in accounting for the nature of Wh-questions in (Tokyo) Japanese (Deguchi and Kitagawa 2002, Ishihara 2002a, b, 2003, 2004, Kitagawa and Deguchi 2002, Kitagawa and Fodor 2003, 2006, Kitagawa 2005, Kuroda 2005; see also Hirotsu 2003 et. seq., and Sugahara 2003). It is argued that the licensing and interpretation of Wh-phrases are closely tied to the Focus Intonation Prosody (FIP) that Wh-questions exhibit, and there is a close correlation between FIP and the interpretation/scope of Wh-phrases, which is referred to here as the Prosody-Scope Correspondence (PSC) (see Sec. 2). This paper argues that the same is true with the licensing and interpretation of *shika*-NPIs in Tokyo Japanese, which require not only syntactic<sup>1</sup> but also prosodic conditioning (i.e., FIP; Ishihara 2005a, b), and demonstrate the PSC (see Sec. 3). Our conclusions provide further credence to the interdisciplinary approach to the theory of grammar, in particular along the line of Kitagawa's (2005) research guidelines (1), casting doubt on "syntax-only" approach(es) (such as Hasegawa's 1994 syntax-only analysis of *shika*-NPIs). For concreteness, I will concentrate on the "syntax-prosody" interface, but other factors such as processing and pragmatics should also be taken into consideration (which I will leave for future investigation).<sup>2, 3</sup>

- (1) **Kitagawa's 2005 Research Guidelines** (Kitagawa 2005: p.303)

"the study of formal aspects of grammar should be conducted with much more careful attention to a larger context of language such as prosody, processing, and pragmatics than usually done"

## 2. Prosody and the Syntax of Wh-questions in Tokyo Japanese

In this section, I will very briefly summarize how prosody plays a pivotal role in understanding the nature of Wh-questions in Japanese.

### 2.1. The Syntax of Wh-questions in Japanese (without Prosody)

The study of Wh-questions in Japanese has always accompanied with conflicting judgments. For example, it is well-known that Wh-island and Wh-movement effects are subject to judgment variations and fluctuations.<sup>4</sup> In an example like (2), while Harada (1972: (12b)), Nishigauchi (1990: Ch.2, (35)) and others reported a Wh-island effect (not allowing the matrix scope reading (2)b), Takahashi (1993: (4a)), Maki and Ochi (1997: (4a)/(18a), Fn.1) and others did not.<sup>5, 6</sup>

- (2) Naoya-ga [<sub>CP</sub> Mari-ga **nani**-o nomiya-de non-da ka]  
 N.-NOM M.-NOM Wh-ACC bar-LOC drink-TNS Q  
 Yumi-ni tsutae-ta no?  
 Y.-DAT tell-TNS Q
- a. ‘Did Naoya tell Yumi [what<sub>i</sub> Mari drank t<sub>i</sub> at the bar]?’  
 (Embedded Scope)
- b. ‘What<sub>i</sub> did Naoya tell Yumi [whether Mari drank t<sub>i</sub> at the bar]?’  
 (Matrix Scope)
- (~Ishihara 2002a: (12))

Although Takahashi found the scope of the in-situ Wh-phrase in (2) ambiguous, he reported that when it undergoes long-distance scrambling, as in (3) (Takahashi (1993: (4b))), it becomes unambiguous and only the matrix scope reading is available, further arguing that such scope-fixing effects indicate that such scrambling counts as Wh-movement. Maki and Ochi (1997: (4b)/(18b), Fn.1), however, observed that there is no such scope-fixing effect, allowing the embedded scope reading.

- (3) **Nani**-o<sub>i</sub> Naoya-ga [<sub>CP</sub> Mari-ga nomiya-de t<sub>i</sub> non-da ka]  
 Wh-ACC N.-NOM M.-NOM bar-LOC drink-TNS Q  
 Yumi-ni tsutae-ta no?  
 Y.-DAT tell-TNS Q
- a. ‘Did Naoya tell Yumi [what<sub>i</sub> Mari drank t<sub>i</sub> at the bar]?’  
 (Embedded Scope)
- b. ‘What<sub>i</sub> did Naoya tell Yumi [whether Mari drank t<sub>i</sub> at the bar]?’  
 (Matrix Scope)
- (~Ishihara 2002a: (20))



## 2.2. Focus Intonation Prosody and Prosody-Scope Correspondence in Wh-questions<sup>7, 8, 9, 10</sup>

### 2.2.1. Focus Intonation Prosody (FIP)

Deguchi and Kitagawa (2002) and Ishihara (2002a, b) have shown that Wh-questions in Japanese exhibit what I refer to as Focus Intonation Prosody (FIP) (4) (See also Kitagawa and Deguchi 2002 and Ishihara 2003, 2004).

(4) **Focus Intonation Prosody in Wh-questions ( $FIP_{Wh}$ )**:

Wh-questions require

- (i) **F<sub>0</sub>-boosting of Wh-phrases** ( $F_0$  = fundamental frequency),
  - (ii) followed by F<sub>0</sub>-compression until its licensing Q.
  - (iii) F<sub>0</sub>-reset on the material after the licensing Q, if there is one<sup>11</sup>
- (~Ishihara 2002a: (2), “Focus Intonation Pattern”)

Thus, the Wh-question in (5), in contrast to the corresponding “normal/non-focus” sentence in (6), exhibits  $FIP_{Wh}$ .

- (5) Mari-ga **nani-o** nomiya-de non-da **no?**  
 M.-NOM Wh-ACC bar-LOC drink-TNS Q  
 ‘What<sub>t</sub> did Mari drink <sub>t</sub> at the bar?’  
 (~Ishihara 2002a: (3b); Kitagawa 2005: (2a))

- (6) Mari-ga ramu-o nomiya-de non-da no/yo.  
 M.-NOM rum-ACC bar-LOC drink-TNS SFP  
 ‘Mari drank rum at the bar.’  
 (~Ishihara 2002a: (3a))

### 2.2.2. Prosody-Scope Correspondence (PSC)

Deguchi and Kitagawa (2002) and Ishihara (2002a, b) have shown that, once prosodic factors ( $FIP_{Wh}$ ) are properly controlled for, there are no “real” Wh-island/movement effects (at least in Tokyo Japanese),<sup>12</sup> and the alleged syntactic effects are due to the inappropriate control of  $FIP_{Wh}$ .

“Wh-island” effects noted in Harada 1972, Nishigauchi 1990, and Watanabe 1992a, b, for example, will diminish when  $FIP_{Wh}$  is properly taken into consideration, and the example (2) can be prosodically disambiguated, as indicated in (7) and (8).

- (7) = (2)a; Embedded Scope; F<sub>0</sub>-compression until the embedded Q.  
 Naoya-ga [<sub>CP</sub> Mari-ga **nani-o** nomiya-de non-da ka]  
 N.-NOM M.-NOM Wh-ACC bar-LOC drink-TNS Q  
 Yumi-ni tsutae-ta no?  
 Y.-DAT tell-TNS Q  
 ‘Did Naoya tell Yumi [what<sub>i</sub> Mari drank t<sub>i</sub> at the bar]?’  
 (~Ishihara 2002a: (13a); D&K 2002: (20a), Kitagawa 2005: (6a))
- (8) = (2)b; Matrix Scope; F<sub>0</sub>-compression until the matrix Q.  
 Naoya-ga [<sub>CP</sub> Mari-ga **nani-o** nomiya-de non-da ka]  
 N.-NOM M.-NOM Wh-ACC bar-LOC drink-TNS Q  
Yumi-ni tsutae-ta no?  
 Y.-DAT tell-TNS Q  
 ‘What<sub>i</sub> did Naoya tell Yumi [whether Mari drank t<sub>i</sub> at the bar]?’  
 (~Ishihara 2002a: (13b); D&K 2002: (21), Kitagawa 2005: (6b))

Similarly, Takahashi’s (1993) alleged “Wh-movement” effects of long-distance scrambling of Wh-phrases in Japanese in (3) (observed to allow only the matrix scope interpretation) are in fact illusory; (3)b is in fact ambiguous (allowing both the matrix and embedded scope interpretation) and is prosodically disambiguated, as shown in (9) and (10).

- (9) = (3)a; Embedded Scope; F<sub>0</sub>-compression until the embedded Q.  
**Nani-o<sub>i</sub>** Naoya-ga [<sub>CP</sub> Mari-ga nomiya-de t<sub>i</sub> non-da ka]  
 Wh-ACC N.-NOM M.-NOM bar-LOC drink-TNS Q  
 Yumi-ni tsutae-ta no?  
 Y.-DAT tell-TNS Q  
 ‘Did Naoya tell Yumi [what<sub>i</sub> Mari drank t<sub>i</sub> at the bar]?’  
 (~Ishihara 2002a: (20a); D&K 2002: (32b))
- (10) = (3)b; Matrix Scope; F<sub>0</sub>-compression until the matrix Q.  
**Nani-o<sub>i</sub>** Naoya-ga [<sub>CP</sub> Mari-ga nomiya-de t<sub>i</sub> non-da ka]  
 Wh-ACC N.-NOM M.-NOM bar-LOC drink-TNS Q  
Yumi-ni tsutae-ta no?  
 Y.-DAT tell-TNS Q  
 ‘What<sub>i</sub> did Naoya tell Yumi [whether Mari drank t<sub>i</sub> at the bar]?’  
 (~Ishihara 2002a: (20b); D&K 2002: (32a))

In sum, what Deguchi and Kitagawa (2002) and Ishihara (2002a, b) showed is that there is a close correlation between FIP<sub>Wh</sub> and the interpretation of Wh-phrase, which I call the Prosody-Scope Correspondence (PSC).<sup>13</sup>

(11) Prosody-Scope Correspondence in Wh-questions (PSC<sub>Wh</sub>):

The scope of Wh-phrases is determined and indicated by the (post-focus) F<sub>0</sub>-compression between Wh-phrases and the Q-particle (that (once) c-commanded Wh-phrases).

(~D&K 2002: pp.86–87, Ishihara 2002: (11))

To conclude this section, the above discussion succinctly, but convincingly shows that the prosodic factors (FIP and PSC) are necessary and indispensable for the proper understanding of Wh-questions in Japanese.

### 3. Prosody and the Syntax of *Shika*-NPI Constructions in Tokyo Japanese

I argue that what has been noted for Wh-questions in Tokyo Japanese is also observed with the *shika*-NPI constructions in Tokyo Japanese, which provides additional evidence for the interdisciplinary approach to the theory of grammar, along the line of Kitagawa's research guidelines in (1).<sup>14, 15</sup>

#### 3.1. The Syntax of *Shika*-NPI Constructions (without Prosody)

Hasegawa (1994) observes that otherwise ambiguous (12) becomes unambiguous when *shika*-NPI is scrambled to the vicinity of matrix Neg as in (13) (allowing only the matrix scope interpretation), akin to Takahashi's (1993) observation regarding the Wh-movement effect of long-distance scrambling of Wh-phrase, and argues that A'-movement of an NPI to NegP-Spec fixes scope (Hasegawa 1994: (18)).<sup>16, 17</sup> (N.B. CC = control complement)

- (12) Naoya-wa Mari-ni [<sub>CC</sub> PRO sono ramu-shika nomiya-de  
N.-TOP M.-DAT that rum-SHIKA bar-LOC  
noma-na-i-yooni] iwa-nakat-ta.  
drink-NEG-TNS-C tell-NEG-TNS
- a. 'Naoya did not tell Mari [that she should <sub>(Neg)</sub> drink <sub>(NPI only)</sub> that rum] at the bar.'  
(Embedded Scope)
- b. 'It <sub>(Neg)</sub> was <sub>(NPI only)</sub> that rum] [that Naoya told Mari [not to drink at the bar]].'  
(Matrix Scope)
- (~Hasegawa 1994: (4c/16a), with her judgment)

- (13) Sono ramu-shika<sub>i</sub> Naoya-wa Mari-ni [<sub>CC</sub> PRO t<sub>i</sub> nomiya-de  
 that rum-SHIKA N.-TOP M.-DAT bar-LOC  
 noma-na-i-yooni] iwa-nakat-ta.  
 drink-NEG-TNS-C tell-NEG-TNS  
 a. \* (Embedded Scope)  
 b. (Matrix Scope)  
 (~Hasegawa 1994: (16b), with her judgment)

The judgment in (12) and (13), especially the crucial contrast regarding the unavailability of the embedded scope reading in (13), however, may not be as clear as Hasegawa observes, especially once FIP is taken into consideration.

### 3.2. Focus Intonation Prosody and Prosody-Scope Correspondence in *Shika*-NPI Constructions

#### 3.2.1. Focus Intonation Prosody (FIP)

Ishihara (2005a, b) has shown (see also Hirotani 2004), by conducting an experimental study, that essentially the same FIP found in Wh-questions is also found in *shika*-NPI constructions, as stated in (14).<sup>18</sup>

- (14) ***Focus Intonation Prosody in shika-NPI constructions (FIP<sub>shika</sub>)***:

*Shika*-NPI constructions require

- (i) **F<sub>0</sub>-boosting of XP** *-shika* attaches to,
  - (ii) followed by **F<sub>0</sub>-compression until its licensing *Neg***.
  - (iii) F<sub>0</sub>-reset on the material after the licensing *Neg*, if there is one<sup>19</sup>
- (~Ishihara 2005b: (2), “NPI-FI Hypothesis”)

In this construction, an XP marked with *-shika* gets F<sub>0</sub>-boosted and the following sequence up until the licensing negation is F<sub>0</sub>-compressed, as indicated in (15). This should be contrasted with (16) where the corresponding XP is not marked by *-shika*. No FIP is detected in this “normal” declarative sentence with negation, which exhibits “Normal” Intonation Prosody.

- (15) Mari-ga **ramu-shika** nomiya-de noma-nakat-ta.  
 M.-NOM rum-SHIKA bar-LOC drink-NEG-TNS  
 ‘Mari<sub>(Neg)</sub> drank [<sub>NPI</sub> only rum] at the bar.’  
 (~Ishihara 2005b: (5B))
- (16) Mari-ga ramu-o nomiya-de noma-nakat-ta.  
 M.-NOM rum-ACC bar-LOC drink-NEG-TNS  
 ‘Mari didn’t drink rum at the bar.’  
 (~Ishihara 2005b: (5A))

### 3.2.2. Prosody-Scope Correspondence (PSC)

I argue that, once  $FIP_{shika}$  is taken into consideration, (13) is in fact ambiguous and is prosodically disambiguated and such ambiguity shows that PSC is at work for *shika*-NPI construction as well, as stated in (17),<sup>20</sup> making Hasegawa's original observation that (13) lacks the embedded scope reading and "syntax-only" analysis (that depends on it) quite dubious. Thus, it is not the type of movement (and/or movement to a particular landing site, e.g., NegP-Spec) but the prosody that determines and indicates the scope of *shika*-NPI.

(17) **Prosody-Scope Correspondence in shika-NPI constructions ( $PSC_{shika}$ )**:

The scope of *shika*-NPIs is determined and indicated by the (post-focus)  $F_0$ -compression between *shika*-NPIs and the sentential negation morpheme (that (once) c-commanded *shika*-NPIs).

(17) and (18) indicate how the  $FIP_{shika}$  disambiguates the embedded and matrix scope reading associated with (12), where *shika*-NPI stays in-situ.<sup>21</sup>

(18) = (12)a; Embedded Scope;  $F_0$ -compression until the embedded Neg.  
 Naoya-wa Mari-ni [<sub>CC</sub> PRO **sono ramu-shika nomiya-de**  
 N.-TOP M.-DAT that rum-SHIKA bar-LOC  
noma-na-i-yooni] iwa-nakat-ta.  
 drink-NEG-TNS-C tell-NEG-TNS  
 'Naoya did not tell Mari [that she should <sub>(Neg)</sub> drink <sub>(NPI)</sub> only  
 that rum] at the bar.'

(19) = (12)b; Matrix Scope;  $F_0$ -compression until the matrix Neg.  
 Naoya-wa Mari-ni [<sub>CC</sub> PRO **sono ramu-shika nomiya-de**  
 N.-TOP M.-DAT that rum-SHIKA bar-LOC  
noma-na-i-yooni] iwa-nakat-ta.  
 drink-NEG-TNS-C tell-NEG-TNS  
 'It <sub>(Neg)</sub> was <sub>(NPI)</sub> only that rum [that Naoya told Mari [not to  
 drink at the bar]].'

Crucially, the disambiguation strategy by  $FIP_{shika}$  is at work for the scrambling example as well, as shown in (20) and (21).

- (20) = (13)a; Embedded Scope; F<sub>0</sub>-compression until the embedded Neg.  
**Sono ramu-shika<sub>i</sub>** Naoya-wa Mari-ni [<sub>CC</sub> PRO t<sub>i</sub> nomiya-de  
 that rum-SHIKA N.-TOP M.-DAT bar-LOC  
noma-na-i-yooni] iwa-nakat-ta.  
 drink-NEG-TNS-C tell-NEG-TNS  
 ‘Naoya did not tell Mari [that she should <sub>(Neg)</sub> drink [<sub>NPI</sub> only  
 that rum] at the bar].’
- (21) = (13)b; Matrix Scope; F<sub>0</sub>-compression until the matrix Neg.  
**Sono ramu-shika<sub>i</sub>** Naoya-wa Mari-ni [<sub>CC</sub> PRO t<sub>i</sub> nomiya-de  
 that rum-SHIKA N.-TOP M.-DAT bar-LOC  
noma-na-i-yooni] iwa-nakat-ta.  
 drink-NEG-TNS-C tell-NEG-TNS  
 ‘It <sub>(Neg)</sub> was [<sub>NPI</sub> only that rum] [that Naoya told Mari [not to drink  
 at the bar]].’

What is crucial in the present discussion is that, the availability of embedded scope in (13)a, as indicated by the FIP<sub>shika</sub> in (20), shows that Hasegawa’s (1994) analysis, which is based on the absence of such a reading, cannot be maintained. The scope possibilities of *shika*-NPI constructions thus exemplify that the prosodic factors (FIP and PSC) are necessary and indispensable for the proper understanding of *shika*-NPIs, on a par with Wh-questions in Japanese.

#### 4. Concluding Remarks

A number of recent works (such as Deguchi and Kitagawa 2002 and Ishihara 2002a, b) which paid attention to the prosodic properties of Wh-questions revealed that certain apparently syntactic effects observed for this construction are actually prosodic in nature. I have shown in this paper that virtually the same holds for the *shika*-NPI constructions in Tokyo Japanese in that it exhibits Focus Intonation Prosody (FIP) and Prosody-Scope Correspondence (PSC), akin to what is found in Wh-questions in Tokyo Japanese. I hope to have shown that the prosodic factors (FIP and PSC) are necessary and indispensable for the proper understanding of not only Wh-questions but also *shika*-NPIs construction, calling for the necessity of an interdisciplinary approach to the theory of grammar, which is couched under Kitagawa’s research guidelines in (1). As I see it, we must pay serious attention to the prosodic properties when conducting the syntactic analyses, especially of those constructions which obligatorily exhibit FIP.<sup>22</sup>

## Notes

\* I would like to thank Jun Abe, Hiroshi Aoyagi, Shinichiro Ishihara, Yasuhiko Kato, Shin-Sook Kim, James Mesbur, Asako Uchibori, Akira Watanabe, Keiko Yoshimura, two anonymous *Japanese/Korean Linguistics* 16 abstract reviewers, and audiences at *JK* 16 (Kyoto University, Oct. 7–9), *WECOL* 2006 (California State University, Fresno, Oct. 27–29), and *International Conference on East Asian Linguistics* (University of Toronto, Nov. 10–12) for rewarding discussions, comments, and clarifications. All remaining errors are, of course, solely my own.

<sup>1</sup> Since the main purpose of this paper is to show that prosody plays a role in understanding *shika*-NPI constructions, I will not spend much time on the syntactic licensing conditions of *shika*-NPIs (see Yamashita 2007b; but see Notes 14 and 16). The *shika*-NPI examples used in this paper satisfy all syntactic conditions, e.g., the *shika*-NPI must be c-commanded by a clause-mate negation. Also, I won't make any commitment regarding the distinction between 'Negative Polarity Item' and 'Negative Concord Item' (see Watanabe 2004).

<sup>2</sup> Kitagawa (2005) argues that not only prosody, but also other factors (such as pragmatics and processing) must be taken into considerations in investigating Wh-questions in Japanese. See also the series of works he is involved with, some of which are listed in the references of this paper.

<sup>3</sup> Throughout the paper, I only deal with Tokyo Japanese (in a broad sense, which includes the surrounding areas of Tokyo). But see Notes 12 and 18 for some possible issues concerning other dialects.

<sup>4</sup> Only the representative literature is referred here. But see also Watanabe 1992a, b.

<sup>5</sup> All the Japanese examples are transcribed in the *Hepburn* ("Hebon")-style Romanization (e.g., *-shika*, not *-sika*, which is with *Kunrei*-style Romanization), except for a long vowel (e.g., I will transcribe *-yooni*, not *-yoni*). Most of the examples cited in this paper are modified, but in a way that does not distort the intention of the original data. I use the mark '~' when the cited data are not exactly the same (even if it is a slight modification). The translations are provided to illustrate the rough structures of the examples and are not meant to be "correct" English translations.

<sup>6</sup> Throughout the paper, I will gloss *-ka* as 'Q' even when it is interpreted as *whether*. For example, the embedded Q *-ka* functions as *whether* under the matrix scope interpretation (2)b.

<sup>7</sup> See Poser 1984, Pierrehumbert and Beckman 1988, Kubozono 1993, among others for the basics of prosody and intonation in Japanese.

<sup>8</sup> Unfortunately, there is (still) no consensus on the terminologies regarding the prosody in Japanese. (E.g., No previous work used FIP as Focus Intonation Prosody.)

<sup>9</sup> I will use the following notations in indicating the prosody. **Bold** for F<sub>0</sub>-boosting, underline for F<sub>0</sub>-compression. I will also italicize and shade the relevant licensing head (e.g., *-na*- 'Neg', *-ka/-no* 'Q').

<sup>10</sup> Due to space limitations, I cannot provide any pitch tracks. See the cited works.

<sup>11</sup> E.g., the F<sub>0</sub>-peak on *Yumi* in (7), which follows the embedded Q that licensed Wh-phrase, is retained, whereas that of *Yumi* in (8), which is inside the domain of F<sub>0</sub>-compression, is not.

<sup>12</sup> Keiko Yoshimura (p.c. Oct., 2006, Jan., 2007) informed me that even with the prosody indicated, she still detects a Wh-island effect. What is of interest to note is that those (Taisuke Nishigauchi, Akira Watanabe, and Keiko Yoshimura) who report the Wh-island effect are native speakers of Kansai Japanese (in a broad sense, which includes areas such as Kobe, Kyoto, Nara, Osaka), and those who do not are native speakers of non-Kansai Japanese (with the exception of Kazuko I. Harada, who first noted the Wh-island effect in Japanese). It may be possible that the prosody of Kansai Japanese may be involved in making the matrix scope impossible, even though Tokyo Japanese is used as data (e.g., in Nishigauchi 1990, Watanabe 1992a, b). I leave this speculation/issue for a future investigation.

<sup>13</sup> The term "Prosody-Scope Correspondence" should be distinguished from Hirotani's (2003, et. seq.) "Scope-Prosody Correspondence," which is a processing principle. Hirotani argues that, based on the experimental studies, although FIP as indicated in (8) is necessary for a Wh-phrase inside a Wh-island to take a matrix scope, such FIP does not force such reading, and the embedded scope is also available. Note also that "prosody" Hirotani refers to is different from FIP in that it involves the

prosodic phrasing of Major Phrase (MaP). See Ishihara (2003, 2004) for argument that FIP and MaP involve different operations.

<sup>14</sup> See Oyakawa 1975, Muraki 1978, Kato 1985, Aoyagi and Ishii 1994, and references cited therein, for the basics of the syntax of *shika*-NPIs in Japanese. I won't make any commitment regarding the semantics of *shika*-NPIs (see e.g., Yoshimura 2007/this volume, and references cited therein).

<sup>15</sup> All the *shika*-NPIs used in this paper are 'bare' in the sense that there is no Case-marker/postposition on the XP *-shika* attaches to, but the same effect obtains with the *shika*-NPIs with Case-marker/postposition (e.g., *XP-ni-shika* 'XP-DAT-SHIKA').

<sup>16</sup> Although *shika*-NPIs are subject to the clause-mate condition (but see Yamashita 2003a, b), *shika*-NPIs in the embedded clause can be licensed by the matrix negation when the embedded clause is a control complement (Muraki 1978, Nemoto 1993). See also Yamashita 2007b for related discussions.

<sup>17</sup> I assume here that *shika*-NPI in (12) stays in-situ inside the embedded clause. 'In-situ' is used here in a broad sense in that *shika*-NPIs are not scrambled out of the clause it is base-generated in. Note that it may be possible to scramble string-vacuously out of the embedded clause to some position in the matrix clause below the matrix indirect object. Such an option may plausibly be blocked by placing an appropriate adverb that modifies only the embedded verb. I won't place any such adverb, so as not to make the sentence complex, but I note here that placing such adverb does not interfere with the interpretation of *shika*-NPIs in any significant way.

<sup>18</sup> Although *shika*-NPI constructions and Wh-questions in Tokyo Japanese exhibit essentially the same FIP, it does not necessarily mean that this holds for other dialects as well. As Tomoyuki Kubo (p.c., Oct., 2006) pointed out to me, *shika*-NPI constructions in Fukuoka Japanese does not exhibit the same FIP observed for Wh-questions. I also note here that FIP of Wh-questions in Fukuoka Japanese is something different from that of Tokyo Japanese. See Kubo 1989 and his subsequent works on the FIP of Wh-questions in Fukuoka Japanese.

<sup>19</sup> Since the F<sub>0</sub>-peak on the verbal predicate is in principle subject to a pitch-lowering process (*Downstep*), (see Poser 1984, Kubozono 1993, among others), this effect may not be easily detected. See Ishihara 2005b: Sec.7.2 for related discussions, as well as Yamashita 2007b.

<sup>20</sup> Recall (see Note 13) that the difference between "Prosody-Scope Correspondence" and Hirotoni's "Scope-Prosody Correspondence," which is a processing principle. This does not mean, however, that PSC plays no role in the processing of *shika*-NPI constructions. Experimental investigations should verify this, which I leave for future research.

<sup>21</sup> There are, however, complications in the examples (18) and (19), and the same holds for (20) and (21). I will clarify it in Yamashita 2007b.

<sup>22</sup> See Yamashita 2005/in progress, 2007a where it is shown that prosody plays a pivotal role in accounting the nature of "split indeterminate NPI pronouns" in (Tokyo) Japanese (e.g., ... *dare* ... *V-mo-si*-Neg, ... *dare* ... *mo* ... *V*-Neg; see Kuroda 1965: Ch.3, sec.5, pp.93–95, 2005).

## References

- Aoyagi, H. and T. Ishii. 1994. On NPI Licensing in Japanese. In N. Akatsuka (ed.), *Japanese/Korean Linguistics* 4, 295–311. Stanford, Calif.: CSLI.
- Deguchi, M. and Y. Kitagawa. 2002. Prosody in Wh-questions. In M. Hirotoni (ed.), *NELS* 32, 73–92. Amherst, Mass.: GLSA.
- Harada, K.-I. 1972. Constraints on Wh-Q Binding. *Studies in Descriptive and Applied Linguistics* 5, 180–206. Tokyo: International Christian University.
- Hasegawa, N. 1994. Economy of Derivation and A'-movement in Japanese. In M. Nakamura (ed.), *Current Topics in English and Japanese*, 1–25. Tokyo: Hituzi Syobo.



- Hirotnani, M. 2003. Prosodic Effects on the Interpretation of Japanese Wh-questions. In L. Alonso-Ovalle (ed.), *UMOP 27: On Semantic Processing*, 117–137. Amherst, Mass.: GLSA.
- Hirotnani, M. 2004. Prosodic Scope: Studies on Prosodic Grouping. Paper presented at *Workshop on Prosody, Syntax, and Information Structure*, Indiana University, 5/27–29/2004.
- Hirotnani, M. 2005a. *Prosody and LF Interpretation: Processing Japanese Wh-questions*. Doctoral dissertation, University of Massachusetts, Amherst.
- Hirotnani, M. 2005b. Prosodic Processing of Scope Relevant Items in Japanese. Paper presented at *Workshop on Prosody, Syntax, and Information Structure 2*, University of Potsdam, 3/18/2005.
- Ishihara, S. 2002a. Invisible but Audible Wh-scope Marking: Wh-constructions and Deaccenting in Japanese. In L. Mikkelsen and C. Potts (eds.), *WCCFL 21*, 180–193. Somerville, Mass.: Cascadilla Press.
- Ishihara, S. 2002b. Syntax-Phonology Interface of Wh-constructions in Japanese. In Y. Otsu (ed.), *The Proceedings of the 3<sup>rd</sup> Tokyo Conference on Psycholinguistics*, 165–189. Tokyo: Hituzi Syobo.
- Ishihara, S. 2003. *Intonation and Interface Conditions*. Doctoral dissertation, MIT.
- Ishihara, S. 2004. Prosody by Phase: Evidence from Focus Intonation–Wh-scope Correspondence in Japanese. In S. Ishihara, et. al. (eds.), *Interdisciplinary Studies on Information Structure 1: Working Papers of SFB632*, 77–119. Potsdam: University of Potsdam.
- Ishihara, S. 2005a. Intonation of Sentences with an NPI. Paper presented at *Workshop on Prosody, Syntax, and Information Structure 2*, University of Potsdam, 3/18/2005.
- Ishihara, S. 2005b. Intonation of Sentences with an NPI: Experiment Overview. Ms. (3/25/2005), University of Potsdam.
- Kato, Y. 1985. Negative Sentences in Japanese. *Sophia Linguistica* 19. Tokyo: Sophia University.
- Kitagawa, Y. 2005. Prosody, Syntax and Pragmatics of Wh-questions. *English Linguistics* 22:2, 302–346. Tokyo: Kaitakusha.
- Kitagawa, Y. and M. Deguchi. 2002. *Prosody in Syntactic Analyses*. Ms. (Ver.4, June, 2002), Indiana University.
- Kitagawa, Y. and J. D. Fodor. 2003. Default Prosody Explains Neglected Syntactic Analyses of Japanese. In W. McClure (ed.), *Japanese/Korean Linguistics* 13, 267–279. Stanford, Calif.: CSLI.
- Kitagawa, Y. and J. D. Fodor. 2006. Prosodic Influence on Syntactic Judgments. In G. Fanselow et. al. (eds.), *Gradience in Grammar: Generative Perspectives*, 336–358. Oxford University Press.
- Kubo, T. 1989. Fukuoka-shi Hougen-no dare/nani-tou-no Gimonshi-o Fukumu Bun-no Pitchi Pataan [The Pitch Patterns of Sentences Containing Wh-words such as dare/nani in the Fukuoka-city Dialect]. *Kokugogaku* 156, 71–82.
- Kubozono, H. 1993. *The Organization of Japanese Prosody*. Tokyo: Kuroshio.
- Kuroda, S.-Y.. 1965. *Generative Grammatical Studies in Japanese*. Doctoral dissertation, MIT.
- Kuroda, S.-Y.. 2005. Prosody and the Syntax of Indeterminates. In D. Roehrs et. al. (eds.), *Syntax and Beyond (Indiana University Working Papers in Linguistics, vol.5)*, pp–11p. Bloomington, Indiana: Indiana University Linguistics Club.

- Maki, H. and M. Ochi. 1999. Scrambling of Wh-Phrases and the Move F Hypothesis. In D. J. Silva (ed.), *Japanese/Korean Linguistics* 8, 487–500. Stanford, Calif.: CSLI.
- Muraki, M. 1978. The *sika nai* Constructions and Predicate Restructuring. In J. Hinds and I. Howard (eds.), *Problems in Japanese Syntax and Semantics*, 155–177. Tokyo: Kaitakusha.
- Nemoto, N. 1993. *Chains and Case Positions: A Study of Scrambling in Japanese*. Doctoral dissertation, University of Connecticut.
- Nishigauchi, T. 1990. *Quantification in the Theory of Grammar*. Dordrecht: Kluwer Academic Press.
- Oyakawa, T. 1975. On the Japanese *sika nai* Construction. *Gengo Kenkyu* (Journal of the Linguistic Society of Japan) 67, 1–20.
- Pierrehumbert, J. and M. Beckman. 1988. *Japanese Tone Structure*. Cambridge, Mass.: MIT Press.
- Poser, W. J. 1984. *The Phonetics and Phonology of Tone and Intonation in Japanese*. Doctoral dissertation, MIT.
- Sugahara, M. 2003. *Downtrends and Post-FOCUS Intonation in Tokyo Japanese*. Doctoral dissertation, University of Massachusetts, Amherst.
- Takahashi, D. 1993. Movement of Wh-phrases in Japanese. *Natural Language and Linguistic Theory* 11:4, 655–678.
- Watanabe, A. 1992a. Subjacency and S-structure Movement of WH-in-situ. *Journal of East Asian Linguistics* 1:3, 255–291.
- Watanabe, A. 1992b. Wh-in-situ: Subjacency and Chain Formation. *MIT Occasional Papers in Linguistics* 2. Cambridge, Mass.: MITWPL.
- Watanabe, A. 2004. The Genesis of Negative Concord: Syntax and Morphology of Negative Doubling. *Linguistic Inquiry* 35:4, 559–612.
- Yamashita, H. 2003a. On the Distribution and Licensing of Negative Polarity Items in Japanese and the Phase Impenetrability Condition. In Y. Otsu (ed.), *The Proceedings of the 4<sup>th</sup> Tokyo Conference on Psycholinguistics*, 313–337. Tokyo: Hituzi Syobo.
- Yamashita, H. 2003b. Phase Theory and the Locality Condition of NPI Licensing in Japanese. Paper presented at *Ling-Lunch*, MIT, 5/8/2003.
- Yamashita, H. 2005/in progress. *And Then There Were None Who Believes It (Soshite Dare-mo Shinji-naku-natta/Soshite Dare-ga Shinji-mo shi-naku-natta)* [Tentative/Working Title]. Ms., Yokohama National University.
- Yamashita, H. 2007a. *On the So-called “Split Indeterminate NPI Pronouns” in Japanese and Its Implications for the Theory of Grammar*. [Tentative/Working Title]. Ms., Yokohama National University. [To appear in *Proceedings of the International Conference on East Asian Linguistics*. Toronto, Ont.: University of Toronto.]
- Yamashita, H. 2007b. *Shika-NPIs in Tokyo Japanese and the Syntax-Prosody Interface*. Ms., Yokohama National University. [To appear in *Japanese/Korean Linguistics* 16. Stanford, Calif.: CSLI.]
- Yoshimura, K. 2007. The Semantics of Focus Particle *-shika* ‘only’ in Japanese. Ms., University of Chicago. [To appear in *WECOL* 2006.]

Hideaki Yamashita  
Yokohama National University  
Graduate School of Environment and Information Sciences  
79-2 Tokiwadai, Hodogaya, Yokohama, Kanagawa. 240-8501. Japan  
hy\_aka\_sange@hotmail.com

# The Semantics of Focus Particle *–shika* ‘only’ in Japanese<sup>♦</sup>

Keiko Yoshimura  
University of Chicago

## 1. Introduction

Japanese exclusive focus particle *–shika* ‘only’ has been analyzed as a negative polarity item (NPI) due to its limited distribution: it is licensed only by clausemate negation (Oyakawa 1975, Muraki 1978). This minimally contrasts with another expression *–dake* ‘only’, which is not polarity sensitive and acts just like English *only* in terms of its distribution and meaning. Examples are given in (1).

- (1) a. John-**shika** ko-**naka**-tta.  
John-SHIKA come-NEG-PAST  
‘Only John came.’  
b. John-**dake** ki-ta.  
John-DAKE come-PAST  
‘Only John came.’

Thus the sentence in (1a) with the negation marker and the one in (1b) without the negation marker convey the same exclusive sentence ‘Only John came.’ The goal of this paper is to examine the semantics of *–shika* and its nature of polarity sensitivity and provide a fully compositional account for this item.

The literatures on the semantics of ‘only’ agree that a sentence such as ‘Only John came’ asserts the negative proposition ‘No one other than John came.’ (Horn 1969, 1996, 2002, Beaver&Clark 2003).<sup>1</sup> There are two possible semantic representations for such a proposition as given below.

- (2) a.  $\neg\exists x[x \neq \text{John} \wedge \text{come}(x)]$  (Horn 1969, 1996)  
b.  $\forall x[x \neq \text{John} \rightarrow \neg\text{come}(x)]$

These two representations are semantically equivalent, yet the debate between the two comparable options given in (3) for n-words in negative concord

structure and/or equivalents of ‘any’ is still ongoing (Kadmon&Landman 1993, Dayal 2004, Horn 2000, Giannakidou 2005, Shimoyama 2004).

- (3) Complete negation
- |    |   |                            |
|----|---|----------------------------|
| a. | $\neg\exists x[Q(x) \wedge P(x)]$       | (Narrow scope existential) |
| b. | $\forall x[Q(x) \rightarrow \neg P(x)]$ | (Wide scope universal)     |

With regard to this debate, crosslinguistic data provides further evidence for the availability and necessity of both options. For example, while English NPI *any* (as opposed to Free Choice *any*) is strongly argued as a narrow scope existential, Shimoyama (2004) argues that Japanese indeterminate pronoun *mo* ‘any’ (henceforth *wh-mo*) must be treated as wide scope universal. This treatment of indeterminate pronoun *mo* is in line with Giannakidou’s treatment of n-words in Greek (emphatic ones), where n-words crosslinguistically must involve two types: existential (indefinite) type and NPI-universal type.

In this paper, I demonstrate that the semantics of Japanese *-shika* is best represented with the wide scope universal with a function of Domain Subtraction (von Stechow 1993). Thus a sentence such as (1a) can be rephrased as ‘Everyone but John did not come’. The difference from a true exceptive sentence is that a universal quantifier is not overtly expressed in the case of a *-shika* sentence. I argue that *Y-shika* constitutes an exceptive phrase ‘every X but Y’. Thus *-shika* contains a universal quantifier in itself. Following Kratzer&Shimoyama (2002), I assume that certain operators can operate over the alternative set and that *-shika* is such an operator, similar to *-mo*. Additionally, *-shika* subtracts the denotation of Y (i.e. its focus associate) from the relevant domain, which is supplied by the alternative set induced by focus (Rooth 1985). The universal quantifier then operates over the resulting set. Consequently, the proposed analysis supports the wide scope universal analysis for n-words (Giannakidou 2005, Surányi 2006), treating the limited distribution of *-shika* as an instance of negative concord, along with *wh-mo* in Japanese (Watanabe 2004). The wide scope universal approach for *-shika* also aligns with Shimoyama’s analysis (1999, 2004) for *wh-mo*, allowing a general observation that Japanese utilizes wide scope universal to convey complete negation. This analysis can fully account for the distribution of *-shika* (i.e. requirement of clausemate negation) by utilizing the existing analysis for universal type n-words whose distribution is identical to *-shika* and *wh-mo*.

The paper is organized as follows. Section 2 presents the previous analyses for the semantics of exceptive markers and illustrate some shared properties between exceptive construction and *-shika* sentences. Section 3 provides the assumptions for the proposed analysis followed by the semantics of *-shika* as containing a domain subtraction function with a universal quantifier. Section 4 discusses the distribution of *-shika* relating to n-words in negative concord structure and provides a full derivation of *-shika* sentence. Here *-shika* is identified as a

paradigm of universal n-words illustrating parallel properties. Section 5 ends the paper with concluding remarks.

## 2. Semantics of exceptive marker and its properties

The basic idea of the semantics of exceptive marker in exceptive sentence such as (4) is that it subtracts the entities that are denoted by NP in the exceptive phrase from the relevant domain (von Fintel 1993, Moltmann 1995).

- (4) Every student *but John* came to the meeting.

This is what I adopt for *-shika* by illustrating the main idea of this analysis with the proposal by von Fintel (1993).

von Fintel (1993) tries to unify the cases with positive and negative quantifiers (*every* and *no*). In a sentence (4), *but* subtracts a singleton set containing *John* out of the restriction (i.e. *student*) of the quantifier *every* and what is left is applied to the predicate *came*. This part of the semantics of *but*-phrases is called ‘Domain Subtraction’ and (5) and (6) illustrate von Fintel’s (1993) first approximation of the semantics of *students but John*, treating *but* as a noun modifier, and *Every/no student but John attended the meeting*, respectively. (5) and (6) are from (11) and (15) from von Fintel (1993).

- (5)  $\llbracket \text{students but John} \rrbracket = \llbracket \text{students} \rrbracket - \{ \llbracket \text{John} \rrbracket \}$   
 (6)  $D \ A \ \llbracket \text{but} \rrbracket \ C \ P = \text{true} \Rightarrow P \in D \ (A-C)$   
 Key for (21):  $D = \llbracket \text{every} \rrbracket, \llbracket \text{no} \rrbracket$   
 $A = \llbracket \text{student} \rrbracket$   
 $C = \{ \llbracket \text{John} \rrbracket \}$   
 $P = \llbracket \text{attended the meeting} \rrbracket$

He then provides ‘Uniqueness Condition’ as defined in (7) and adds this condition to the semantics of the exceptive construction as in (8). This ensures the three conditions of the exceptive construction, which are explicated later along with comparison with *-shika* (von Fintel 1993, (20) and (21) respectively)

- (7) The set of exceptions to a quantified sentence  $D(A)P$  is the smallest set  $C$  such that  $D(A-C)P$  is true.  
 (8)  $D \ A \ \llbracket \text{but} \rrbracket \ C \ P = \text{true} \text{ iff } P \in D \ (A-C) \wedge \forall S (P \in D(A-S) \rightarrow C \subseteq S)$

The main idea I employ for *-shika* is the subtraction of a set as a part of the semantics of *-shika*, which is on par with von Fintel’s Domain Subtraction. For

instance, *shika*-phrase such as *John-shika* subtracts a singleton set {John} from some relevant set/domain.

The semantics of an exceptive marker given here accounts for the basic semantic properties of exception sentences summarized in Moltmann (1995) as three conditions: (i) Negative Condition, (ii) Condition of Inclusion and (iii) Quantifier Constraints. These semantic conditions are shared by sentences involving *-shika*. Due to the limited space, the Quantifier Constraint, which is the most relevant to this discussion, is illustrated with examples.

Quantifier Constraint describes how exceptive phrases cannot associate with non-universal quantifiers such as *most*, *few*, or cardinal ones as the contrast in (9) shows.<sup>2</sup>

- (9) a. Every/All/No student(s) but John came.  
 b. #Most/#Three/#At least three/#Few/#The students but John came.

Application of this condition to *-shika* seems rather difficult since the examples we have seen so far do not overtly provide the quantifier or its restriction. However, it is possible to introduce a restriction set using a bare NP in the *-shika* construction, which is optionally allowed.<sup>3</sup> In (10), *yasai* ‘vegetable’ is optionally allowed.

- (10) John-wa ninjin-shika (**yasai-o**) tabe-naka-tta.  
 John-TOP carrot-SHIKA vegetable-ACC eat-NEG-PAST  
 ‘John didn’t eat any (vegetables) but carrots.’

With the optional bare NP, quantification over this set becomes possible. However, as the examples in (11) illustrate, quantification of any kind on this NP is possible with the presence of *-shika*.

- (11) a. John-wa ninjin-**shika** (**\*mi-ttsu** /\***takusan-no**) yasai-o tabe-naka-tta.  
 John-TOP carrot-SHIKA 3-CL/many-MOD vegie-ACC eat-NEG-PAST  
 ‘John didn’t eat three/many vegetables but carrots.’  
 b. John-wa ninjin-**shika** (**\*zenbu-no**/\***minna**) yasai-o tabe-naka-tta.  
 John-TOP carrot-SHIKA all-MOD/all vegie-ACC eat-NEG-PAST  
 ‘John didn’t eat all vegetables but carrots.’  
 d. John-wa ninjin-**shika** (**\*dono-yasai-mo**) tabe-naka-tta.  
 John-TOP carrot-SHIKA which-vegie-MO eat-NEG-PAST  
 ‘John didn’t eat any/every vegetables but carrots.’

Both non-universal quantifiers (i.e. *mi-ttsu* ‘three’ and *takusan-no* ‘many in (11a)) and universal quantifiers (i.e. *zenbu/minna* ‘all’ in (11b) and *wh-NP-mo* universal ‘every NP’ in (11d)) result in ungrammaticality in *-shika* sentences. Note that the ungrammaticality in (11) clearly stems from the combination of

overt quantifier and the *-shika* phrases. Once we remove the *-shika* phrase, the corresponding sentences become grammatical. While *-shika* is not subject to this particular constraint in the same way *but* is, due to the lacks of an overt (universal) quantifier, the semantic universality seems to be still present. The following demonstrates this point.

- (12) #John-*shika* ko-nak-atta kedo, Bill-wa ki-ta.  
 John-SHIKA come-NEG-PAST but, Bill-CONTR come-PAST  
 ‘#Only John came (=No one but John came) but Bill came.’

The first conjunct of (12) cannot be true if anybody else besides John came. Thus the continuation of ‘Bill came’ results in contradiction. It shows that there is an implicit universality on the relevant set under discussion. Sentences (11) and (12) show that *-shika* sentences convey the universal reading while it does not and cannot co-occur with any overt quantifiers.

At this point, a clarification of a significant difference between exceptive marker and *-shika* is required. While exception sentences and sentences with *-shika* express semantically equivalent material as illustrated in (13) and (14) below, a regular *-shika* construction lacks an overt universal quantifier completely (i.e. *every student*, or *everyone*).

- (13) a. Everyone but John did not come.  
 b. John-**shika** ko-**naka**-tta.  
 John-SHIKA come-NEG-PAST  
 ‘Only John came (Everyone but John did not come).’
- (14)  $\forall x[x \in \llbracket \text{person} \rrbracket - \{\text{John}\} \rightarrow \neg \text{come}(x)]$   
 where  $\{\text{John}\}$  is the smallest set such that the above representation turns out true.

This poses a further question and challenge to the analysis of *-shika*: it is not certain where the relevant domain/set stems from (when a bare NP is not present), but also where the universal interpretation comes from. In the schematic representation given in (15), we have to identify where the interpretation of  $\forall$  and D (a set) arises.

- (15)  $\forall x[x \in D-Q \rightarrow \neg P]$

In the next section, the semantics of *-shika* is spelled out with the proposal that a universal quantifier is a part of the semantics of *-shika* and that point is supported in Section 4.

### 3. Semantics of *-shika*

The proposed analysis posits that *-shika* comes with a universal quantifier, allowing us to make theoretically valuable connection between *-shika* and NPI-universal (i.e. *wh-mo* in Japanese/*n-word* in some languages). Let us first consider the basic *-shika* construction without the optional bare NPs, laying out the theoretical assumptions and basic mechanism of the analysis.

This analysis assumes Rooth's (1985) alternative semantics that focus induces an alternative set. Thus a noun phrase marked with the focus particle *-shika* (e.g. *John-shika*) introduces a set of individuals that is under consideration. Let the relevant context be such that there are seven individuals under consideration, Abby, Bob, Chris, David, Eddie, Fred and John. The focus semantics of *John* in this given context can be defined as the set given in (17).

- (16) [John]<sub>F</sub>-**shika** ko-**naka**-tta.  
John-SHIKA come-NEG-PAST  
'Everyone but John came.'
- (17)  $\llbracket \text{John} \rrbracket^f = \{a, b, c, d, e, f, j\}$   
(  $\llbracket \alpha \rrbracket^f$  represents the focus semantics of  $\alpha$  )

In agreement with von Stechow (1993), I assume that a proper noun such as *John* can be type-shifted to denote a singleton set consisting of one member  $\{\text{John}\}$ . With the assumption that certain operators can operate over the alternatives (e.g. generalized quantifiers in Kratzer&Shimoyama 2002), the semantics of a sentence like (16) can be represented as (18) where C represents the alternative set provided by the focus semantics of *John* in (17). Consequently, the semantics of *-shika* is defined as (19) with the Uniqueness Condition.

- (18)  $\llbracket \text{John-shika ko-naka-tta} \rrbracket = \forall x[x \in C - \{\text{John}\} \rightarrow \neg \text{come}(x)]$   
(19)  $\llbracket \text{-shika} \rrbracket = \lambda Q \lambda P \forall x[x \in C - Q \rightarrow P(x)]^4$   
Uniqueness Condition: the sentence with *-shika* structured as  $\llbracket Q\text{-shika} \neg P \rrbracket$  is true iff Q is the smallest set such that  $\forall x[x \in C - Q \rightarrow \neg P]$  is true.

This approach is analogous to that of Shimoyama (2004) and Kratzer&Shimoyama (2002) for complex *wh-mo* constructions in Japanese where they analyze *wh-word* (=indeterminate pronoun) as introducing the alternatives and *-mo* as the universal quantifier that quantifies over them. The main difference is that the alternative set C is induced by the focus structure (rather than *wh-word*) and that universal quantifier comes from *-shika* (instead of *-mo*). This is an attractive connection since simple *wh-mo* paradigm in Japanese (i.e. *who-mo*, *what-mo*, *where-mo*, etc.) is interpreted as wide scope universal with polarity sensitivity in the same way as *-shika*: they all require



local negation to be grammatical. *Wh-mo* paradigm is thus identified as n-words in negative concord structure (Watanabe 2004) and as wide scope universal (Shimoyama 2004), consequently fitting in the category of NPI-universal in the sense of Giannakidou (2005).

#### 4. Wide Scope Interpretation and its NPI Restriction

In order for the *-shika* as universal analysis to work flawlessly, the negation marker *nai* has to always be interpreted narrowly with respect to the universal quantifier. In addition, the distributional restriction of *-shika* must be encoded somewhere to make sure that it does not appear in environments without negation. In this section, I tackle these two issues, making reference to the available analyses for *wh-mo* construction in Japanese and n-words in negative concord structure (Giannakidou 2000, 2005, Shimoyama 2004, Watanabe 2004). In essence, I adopt the solution provided for universal type n-words (NPI-universal), whose requirement is to combine with a negative predicate. The proposed analysis is potentially compatible with treating the negation either low as often proposed for Japanese negation marker (Furukawa 2005) or high as a standard propositional operator. However, the standard propositional treatment is employed here to avoid any dependence on a special treatment of negation which might be language particular.

##### 4.1 Analysis of n-words in Negative Concord and Connection to *-shika*

As Giannakidou (2000, 2005) summarizes, negative concord structure refers to a construction where there is a negation marker and n-words in a sentence without resulting in double negation. (20) illustrates Italian which employs negative concord (Giannakidou 2005). In contrast, (21) illustrates English which is not a negative concord language. The use of *niente* ‘n-thing’ and *non* ‘not’ results in only one logical negation while *nothing* and sentential negation *not* results in double negation.

- (20) Gianni **non** ha visto **niente**.  
 John not have.3sg. seen n-thing  
 ‘John didn’t see anything.’
- (21) John did **not** see **nothing**.

Watanabe (2004) claims that Japanese NPI *dare-mo* (who-mo) is an n-word, constituting a negative concord.

- (22) John-wa **dare-mo** mi-**naka**-tta.  
 John-TOP who-MO see-NEG-PAST  
 ‘John did not see anyone.’

The variation among n-words is substantial, however, n-words that are identified as displaying universal quantificational force (NPI-universal) exhibit strict NPI-property (i.e. n-words require the presence of negation) and locality (i.e. n-words are clause-bounded). Interestingly, *-shika* exhibits such strict NPI property as well. The following examples illustrate that *-shika* is not licensed without local negation.

- (23) c. \*John-**shika** ki-ta no? (Question)  
 John-SHIKA come-PAST Q  
 ‘(Intended meaning) Did only John come?’  
 d. \*John-**shika** ki-ta-ra, okoru. (Conditional)  
 John-SHIKA come-PAST if upset  
 ‘(Intended meaning) If only John come, (I’ll be) upset.’  
 f. \*Akira-wa [John-**shika** ki-ta to] iwa-**naka** -tta. (non-local)  
 Akira-TOP John-SHIKA come-PAST COMP] say-NEG -PAST  
 ‘(Intended) Akira didn’t say that only John came.’

The analysis of n-word can explain the properties of *-shika* shared with n-word, and especially the negation requirement and its distribution. This analysis is divided into one camp that treats n-word as inherently negative and tries to somehow delete one of the negative meaning (Haegeman and Zanuttini 1991, Watanabe 2004), and the other that treats n-word as inherently non-negative (Giannakidou 2000, 2005). In the latter, there is ongoing debate whether n-word is an indefinite (resulting in narrow scope existential) or a wide scope universal. Giannakidou (2000, 2005) concludes that both options must be available for n-word crosslinguistically and that one or the other may be realized by two different paradigms in a given language. This is illustrated using Greek KANENAS ‘n-person’ and TIPOTA ‘n-thing’ as exhibiting the universal case. This claim is further supported by Hungarian data by Surányi (2006). Given the hypothesis that *-shika* is a universal quantifier (plus the semantics of exceptive marker), I provide a compositional analysis for *-shika*, adapting Giannakidou’s wide scope universal analysis for n-word.

#### 4.2 *-shika* as NPI-universal

As one of the characterizations of NPI-universal, I assume that *-shika* is an item which requires negation to be licensed, whose ‘distinctive feature is encoded in the grammar as a type difference between non-sensitive universals and their NPI-counterparts’ (Giannakidou 2005:13). The negation marker *nai* is treated as

a sentential operator  $\neg$ , thus avoiding the ‘frozen’ narrow scope reading of negation.<sup>5</sup> Once this assumption is made, it becomes necessary to move the universal quantifier above negation to derive the correct reading. This is achieved by quantifier raising (QR) at LF in Giannakidou (2005), whose movement is motivated by their sensitivity requirement to combine with a negative predicate and the need to derive the desired wide scope universal reading. Illustrated below is the full derivation for the sentence in (24), utilizing the semantics of *-shika* provided in (19).<sup>6</sup>

- (24) John-**shika** ko-**naka**-tta..  
 John-SHIKA come-NEG-PAST  
 ‘Only John came. (Everyone but John didn’t come.)’

- (25)  $\forall x[x \in C - \{\text{John}\} \rightarrow \neg \text{come}(x)]$

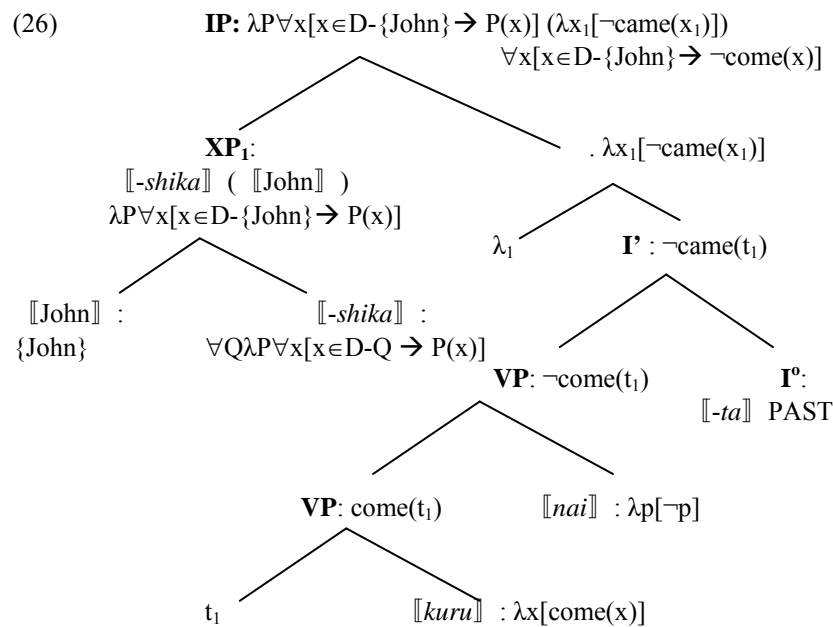

The *-shika* phrase is moved to the specifier position of IP (or NegP if *nai* is treated as Neg<sup>o</sup> heading a NegP) via quantifier raising, allowing the complete compositional analysis with the desired interpretation.

By adapting the wide scope universal analysis of n-word for *-shika*, we can make the parallelism between *-shika* and universal n-word that was not obvious before. They both denote universal quantifier which must take wide scope with respect to negation. The NPI dependency of *-shika* is explained in the same manner as the sentential negation requirement of n-word. Further more, the

typical properties of universal n-words identified in Giannakidou (2005) match the properties of *-shika* as well as *wh-mo*, supporting this approach of analyzing them in the same way. For example, a universal n-word is licensed only by local negation as we saw earlier in Section 4.1. Long distant licensing may be allowed only through an infinitival clause, which is also the case with NPI-universal n-words. The relevant examples are given below, along with NPI *wh-mo* (Muraki 1978, Oyakawa 1975).

- (27) a. Akira-wa [{John-**shika/dare-mo**} ko-**naka-tta** to] i-tta.  
 Akira-TOP John-SHIKA/who-MO come-NEG-PAST COMP] say-PAST  
 ‘Akira said that nobody (but John) came.’  
 b. \*Akira-wa [{John-**shika/dare-mo**} ki-ta to] iwa-**naka-tta**.  
 Akira-TOP John-SHIKA/who-MO come-PAST COMP] say-NEG-PAST
- (28) hahaoya-wa musuko-ni {yasai-**shika/nani-mo**} tabe-sase-**naka-tta**  
 mother-TOP son-DAT vegetable-SHIKA/what-MO eat-allow-NEG-PAST  
 ‘The mother did not allow her son to eat anything (but vegetables).’

Another property of universal n-word that is shared by *-shika* is that its appropriate use requires a strong commitment for a non-empty set. In other words, it is interpreted with an existential presupposition, similar to regular universal quantifier. For example, a sentence in (29b) is judged as strange because it commits us to believe that there is a set of unicorns, which is pragmatically odd in the real world. In contrast, (29a) with indefinite *any* does not have such inference, thus it does not present any oddness.

- (29) a. John did not see any unicorn.  
 b. #John did not see every unicorn.

A similar construction can be made using *-shika*, which also results in a comparable oddness. This stems from the unacceptable presupposition that there exists a set of unicorns.

- (30) #John-wa i-ppiki-no yunikoon-shika mi-naka-tta.  
 John-TOP one-CL-of unicorn-SHIKA see-NEG-PAST  
 ‘John didn’t see every unicorn but one. (John saw only one unicorn.)’

It can be argued that the sentence (30) is odd because the existence of one unicorn is entailed by its assertion that John saw one. However, the existence of ‘other’ unicorns is strongly presupposed by (30), similar to the English *every*, making the sentence even more bizarre.<sup>7</sup> It strongly suggests the universal interpretation that is available from *-shika*.

Further interesting facts with *-shika* can be linked to another property noted as particular to universal n-words, that is, topicality. Observe the difference between *-shika* and *-dake* in the following sentences by Kuno (1999).

- (31) a. Taro<sub>i</sub>-**shika** ikinokora-**nak**-atta. Fuyuno soobi-o shiteinakatta kara da.  
 Taro-SHIKA survive-NEG-PAST  $\emptyset$  winter gear-ACC not.wearing b/c be  
 ‘Only Taro<sub>i</sub> survived. Because \* $\emptyset_i/\emptyset_z$  did not have winter gear.’
- b. Taro<sub>i</sub>-**dake** ikinokotta. ?? Fuyu-no soobi-o shitei-nak-atta kara da.  
 Taro-DAKE survived  $\emptyset$  winter gear-ACC not.wearing because be  
 ‘Only Taro<sub>i</sub> survived. ??Because  $\emptyset_i/*\emptyset_z$  did not have winter gear.’

(31a) and (31b) minimally contrast in the first sentence in the use of the particle, *-shika* or *-dake* ‘only’. The examples in (31) illustrate that the null pronoun in the second sentence refers to different entities depending the choice of the particle. In the sentences with *-dake* in (31b), the null pronoun in the second sentence consistently picks out *Taro* (the associate of *-dake*). In contrast, the null pronoun in the second sentence consistently selects *everyone else besides Taro* (the universally quantified elements). With the assumption that zero pronoun selects topic (Kuno 1999), (31a) illustrates that *everyone else but Taro* is acting as a topic, confirming the observation that universal n-words can be used as topic (Giannakidou 2005). This relates to the fact that universal n-words denote familiar entities while indefinites introduce objects into the discourse, thus cannot be a topic.

As the data in (27)-(28) indicates, both *wh-mo* and *-shika* exhibit the universal quantifier property similar to universal type n-words. In addition, the examples in (30) and (31) further indicated that *-shika* exhibits many of the properties that n-word (and *wh-mo*) displays. This link between *-shika* and n-word is very intriguing, allowing us to make a theoretical connection between *-shika* and *wh-mo* as NPI-universal.

## 5. Conclusions

We set out to provide the semantics of the exclusive particle *-shika*, whose NPI status has been analyzed intensively in syntax without much consideration to its formal semantic properties (Oyakawa 1975, Muraki 1978, Kuno 1999). Incorporating the semantics of exception sentences, the domain subtraction part of the semantics was adapted to the semantics of *-shika*. Due to an obvious lack of ‘overt’ quantifier requirement, while still yielding the universal interpretation, I hypothesized that *-shika* itself contains the universal quantifier. This move allowed for a significant link between *-shika* and n-words (including *wh-mo*): both can be seen as NPI-universal which needs to scope above negation (Shimoyama 2004). Next, I provided a compositional analysis of *-shika*,

employing Giannakidou's (2005) analysis for universal n-words, which moves the universal quantifier over the negation via the operation of QR. The proposed analysis made the compositional analysis possible with the assumption that the alternative set supplies the necessary domain for the operation of subtraction and of quantification. Further evidence was used to support the claim that *-shika* phrase constitutes an exception NP (every X but Y) and that it contains a universal quantifier, rather than an indefinite and/or existential. The distributional restriction of *-shika* was accounted for by treating it as a type of negative concord, implementing a solution available for universal type n-words. This analysis thus presents evidence for the existence (and necessity) of universal n-word (Giannakidou 2005) and additionally postulates an initial connection to the similarity between *-shika* and *wh-mo*.

This analysis of *-shika* also opens a door to a typological investigation for conveying exclusivity and/or exceptionality in natural languages. The fact that English cannot express exclusivity in the same manner as Japanese (e.g. *but John didn't come* to mean 'no one but John came') can be explained as a lack of such lexical item in English. However, it would not be a surprise to find a language similar to Japanese where such item is available, allowing for a similar expression.

## Notes

\* I would like to thank Anastasia Giannakidou and Chris Kennedy for comments on earlier version of this paper. A draft of this paper was presented at Swarthmore Workshop on Negation and Polarity, where I received valuable comments from Laurence Horn, Jay D. Atlas, and Marcel den Dikken. I am grateful to the participants at the Western Conference on Linguistics as well as the organizers of the conference. None of the named above is to be held responsible for shortcomings of this paper.

<sup>1</sup> The status of the positive proposition 'John came' is still under debate (Atlas 1991, 1993, Horn 1969, 1996, 2002, Beaver and Clark 2003). The scope of the paper is primarily to accounting for the asserted part of the sentence.

<sup>2</sup> The issue is more complicated than it seems. The universality is not a sufficient semantic property to rule out the unacceptable ones. Refer to García-Álveraz (2006) and Peters and Westerståhl (2006) for relevant data.

<sup>3</sup> It has to be noted that there is an asymmetry in judgments between subject and object. While bare NPs are accepted in the object position with case marker as seen in (10), the speakers strongly resist the cases where bare NPs is marked with the nominative case marker. The judgment improves if the bare NP is marked with a topic marker. I do not have any explanation to this difference at this point except to note that (ib) is also possible in English with *as for* phrase.

- (i) a. ?? *gakusei-ga John-shika ko-naka-tta.*  
student-NOM John-SHIKA come-NEG-PAST  
b. *gakusei-wa John-shika ko-naka-tta.*  
student-TOP John-SHIKA come-NEG-PAST  
c. As for students, only John came/everyone but John didn't come.

<sup>4</sup> Let us briefly note about the optional bare NP case and how the present analysis would work. The point to emphasize is that a bare NP in *-shika* construction is entirely optional and that a sentence like (1a) is a sufficiently complete sentence. What we would like to achieve from a sentence like (ib) in the footnote 3 is what is given below.

- (i) [[Gakusei-wa John-shika ko-naka-tta]]  
 =  $\forall x[x \in \{x \mid \lambda x.\text{student}(x)\} - \{\text{John}\} \rightarrow \neg \text{come}(x)]$

Basically, when a bare NP is present in *-shika* construction, it should act as the restriction of the universal quantifier provided by *-shika*. It restricts the set C to a set of individuals who are also students. Due to the optional nature of a bare NP, altering the semantics of *-shika* provided earlier is not ideal. However, I consider this case to be equivalent to English topical phrase such as *as for*-phrase as in (ii) and assume that whatever analysis is provided for (ii) would transfer to the *-shika* cases.

- (ii) a. As for students, nobody but John came.  
 b. As for vegetables, John ate nothing but carrots.

<sup>5</sup> Furukawa's (2004, 2005) treatment of negation as an adjective gives this effect of low negation. However, there are many cases where negation may take wide scope, disproving the 'frozen' narrow scope of negation in Japanese (Yoshimura 2007).

<sup>6</sup> I follow the convention of Heim and Kratzer (1998) and assume subject internal hypothesis, thus negation can be adjoined to VP still maintaining its propositional operator status. Alternatively, negation can head its own projection NegP as Giannakidou (2005) proposed for Greek *dhen*.

<sup>7</sup> I would like to thank Lance Nathan for pointing this out to me and sharing the judgment for English.

## References

- Atlas, D. Jay. 1993. 'The importance of being 'only': Testing the neo-Gricean versus neo-entailment paradigms', *Journal of Semantics*, 10:301-318.
- Atlas, D. Jay. 1996. "'Only' noun phrases, pseudo-negative generalized quantifiers, negative polarity items, and monotonicity', *Journal of Semantics*, 13:265-332.
- Beaver, David and Clark Beaver. 2003. 'Always and only: why not all focus-sensitive operators are alike', *Natural Language Semantics*, 11:323-362.
- Dayal, Veneeta. 2004. 'The universal force of free choice *any*', in Pierre Pica (ed.), *Linguistic Variation Yearbook*, 5-40. Amsterdam: John Benjamin.
- von Stechow, Kai. 1993. 'Exceptive Constructions', *Natural Language Semantics*, 1: 123-148.
- Furukawa, Yukio. 2004. 'It's time to say goodbye to syntactic analyses about the SIKANA construction', paper presented at *the 14th Japanese/Korean Linguistics Conference*.
- Furukawa, Yukio. 2005. 'Why can bare NPs in Japanese have universal readings in certain environments?', *Proceedings of Conference of Student Organization of Linguistics in Europe (ConSOLE)*, XIII: 91-105.
- García-Álveraz, Ivan. 2006. 'Connected Exceptives and Nonmonotonic Inference', paper presented at *West Conference on Linguistics 2006*.
- Giannakidou, Anastasia. 2000. 'Negative ... concord?', *Natural Language and Linguistic Theory*, 18: 457-523.
- Giannakidou, Anastasia. 2005. 'N-words and Negative Concord', in H. van Riemsdijk, R. Goedemans et al. (eds), *The Blackwell Companion to Syntax volume III*. Oxford: Blackwell.
- Haegeman, Liliane and Zanuttini Raffaella. 1991. 'Negative heads and the Neg Criterion', *The Linguistic Reviews*, 8: 233-251.

- Hoeksema, Jacob. 1996. 'The Semantics of Exception Phrases', in J. van der Does and van Eijck J. (eds.), *Quantifiers, Logic and Language*, 145-177. Stanford: CSLI Publications.
- Horn, R. Laurence. 1969. 'A presuppositional analysis of only and even', *Proceedings of the Chicago Linguistic Society*, 5: 97-108.
- Horn, R. Laurence. 1996. 'Exclusive company: Only and the dynamic of vertical inference', *Journal of Semantics*, 13:1-40.
- Horn, R. Laurence. 2000. 'Pick a Theory (Not Just Any Theory): indiscriminatives and the Free-Choice Indefinites', in L. R. Horn and Y. Kato (eds), *Negation and Polarity: Syntactic and Semantic Perspectives*, 147-192. Oxford: Oxford University Press.
- Horn, R. Laurence. 2002. 'Assertoric inertia and NPI licensing', *Proceedings of Chicago Linguistic Society, Parasession on Polarity and Negation* 38: 55-82.
- Kadmon, Nirit. and Landman Fred. 1993. 'Any', *Linguistics and Philosophy*, 16: 353-422.
- Kratzer, Angelika. and Shimoyama Junko. 2002. 'Indeterminate Pronouns: The View from Japanese', paper presented at the 3<sup>rd</sup> Tokyo Conference on Psycholinguistics.
- Kuno, Susumu. 1999. 'The Syntax and semantics of the *dake* and *sika* constructions', *Harvard Working Papers in Linguistics*, 7: 144-172
- Moltmann, Friederike. 1995. 'Exception Sentences and Polyadic Quantification', *Linguistics and Philosophy*, 18: 223-280.
- Muraki, Masatake. 1978. 'The shika-nai construction and predicate restructuring', in J. Hinds and Howard I. (eds.), *Problems in Japanese syntax and semantics*, 155-177. Tokyo: Kaitakusha.
- Oyakawa, Takatsugu. 1975. 'On the Japanese *shika-nai* Construction', *Gengo Kenkyuu*, 67: 1-20.
- Peters, Stanley and Dag Westerståhl. 2006. 'Taking Exception to Quantified Statements', a paper presented at *Semantic and Linguistic Theory 16*.
- Rooth, Mats. 1985. *Association with Focus*. Ph.D. Dissertation, University of Massachusetts at Amherst.
- Shimoyama, Junko. 1999. 'Complex NPs and Wh-quantification in Japanese', *Proceedings of North Eastern Linguistic Society*, 9: 355-365.
- Shimoyama, Junko. 2004. 'Wide Scope Universal NPIs in Japanese', paper presented at *Georgetown University Round Table 2004*.
- Surányi, Balázs. 2006. 'Quantification and focus in Negative Concord', *Lingua* 116. 3: 272-313.
- Watanabe, Akira. 2004. 'The Genesis of Negative Concord: Syntax and Morphology of Negative Doubling', *Linguistic Inquiry*, 35. 4: 559-612.
- Yoshimura, Keiko. 2007. *Reanalysis of Scalar Additive Particles: Evidence from Japanese*. Manuscript. University of Chicago.

Keiko Yoshimura  
 University of Chicago  
 1010 E. 59<sup>th</sup> Street  
 Chicago, IL 60637-1512, USA  
 keiko@uchicago.edu